

LBSS84ELT1G S-LBSS84ELT1G

Power MOSFET 60V P-Channel

1. FEATURES

- Advanced trench cell design.
- High speed switch.
- G-S ESD Protected: $\pm 1000V$
- Pb-Free Package is available.
- We declare that the material of product compliance with RoHS requirements and Halogen Free.
- S- prefix for automotive and other applications requiring unique site and control change requirements; AEC-Q101 qualified and PPAP capable.

2. APPLICATIONS

- Portable appliances.
- Load switch appliances.

3. DEVICE MARKING AND ORDERING INFORMATION

Device	Marking	Shipping
LBSS84ELT1G	PE	3000/Tape&Reel

4. MAXIMUM RATINGS($T_a = 25^\circ C$)

Parameter	Symbol	Limits	Unit
Drain-Source Voltage	VDSS	-60	V
Gate-to-Source Voltage	VGSS	± 20	V
Drain Current			mA
- Continuous $T_A = 25^\circ C$	ID	-130	
- Pulsed ($t_p \leq 10\mu s$)	IDM	-520	

5. THERMAL CHARACTERISTICS

Parameter	Symbol	Limits	Unit
Total Device Dissipation, FR-5 Board (Note 1) @ $T_A = 25^\circ C$ Derate above $25^\circ C$	PD	225	mW
		1.8	mW/ $^\circ C$
Thermal Resistance, Junction-to-Ambient(Note 1)	R θ JA	556	$^\circ C/W$
Junction and Storage temperature	TJ, Tstg	-55~+150	$^\circ C$
Maximum Lead Temperature for Soldering Purposes, for 10 seconds	TL	260	$^\circ C$

1. FR-5 = 1.0 \times 0.75 \times 0.062 in.

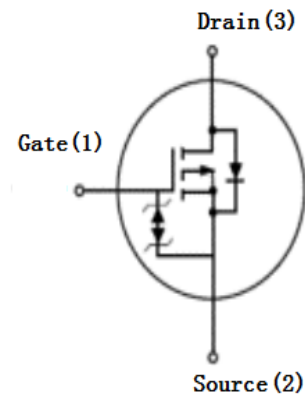
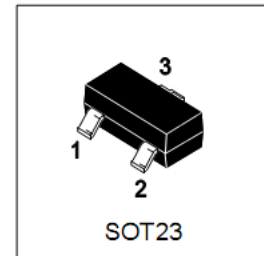

6. ELECTRICAL CHARACTERISTICS (Ta= 25°C)
OFF CHARACTERISTICS

Characteristic	Symbol	Min.	Typ.	Max.	Unit
Drain-Source Breakdown Voltage (VGS = 0, ID = -250μA)	VBRDSS	-60	-	-	V
Zero Gate Voltage Drain Current (VGS = 0, VDS = -25 V) (VGS = 0, VDS = -60 V)	IDSS	-	-	-0.1 -15	μA
Gate-Body Leakage Current, Forward (VGS = 20 V)	IGSSF	-	-	10	μA
Gate-Body Leakage Current, Reverse (VGS = -20 V)	IGSSR	-	-	-10	μA

ON CHARACTERISTICS (Note 2)

Gate Threshold Voltage (VDS = VGS, ID = -250μA)	VGS(th)	-0.9	-	-2	V
Static Drain-Source On-State Resistance (VGS = -5.0 V, ID = -100 mA) (VGS = -10 V, ID = -100 mA)	RDS(on)	-	2 1.8	6 5	Ω
Transfer Admittance (VDS = -25 V, ID = -100 mA, f = 1.0 kHz)	yfs	50	-	-	mS

DYNAMIC CHARACTERISTICS

Input Capacitance (VDS = -25 V, VGS=0V, f=1MHz)	Ciss	-	45	-	pF	
Output Capacitance (VDS = -25 V, VGS=0V, f=1MHz)	Coss	-	4	-	pF	
Reverse Transfer Capacitance (VDS = -25 V, VGS=0V, f=1MHz)	Crss	-	1.5	-	pF	
Total Gate Charge	(VDS = -25V, VGS = -4.5V, ID = -0.1A)	Qg	-	1.1	-	nC
Gate-Source Charge		Qgs	-	0.3	-	
Gate-Drain Charge		Qgd	-	0.2	-	

SWITCHING CHARACTERISTICS

Turn-On Delay Time	(VDS = -25 V, VGEN = -10V, IDS = -0.1 A, RL = 250Ω, RG=6Ω)	td(on)	-	4.8	-	ns
Rise Time		tr	-	19	-	
Turn-Off Delay Time		td(off)	-	52	-	
Fall Time		tf	-	32	-	

SOURCE-DRAIN DIODE CHARACTERISTICS

Continuous Current	IS	-	-	-0.13	A
Pulsed Current	ISM	-	-	-0.52	A
Forward Voltage	VSD	-	-2.2	-	V

2. Pulse Test: Pulse Width ≤ 300 μs, Duty Cycle ≤ 2.0%.

7. ELECTRICAL CHARACTERISTICS CURVES

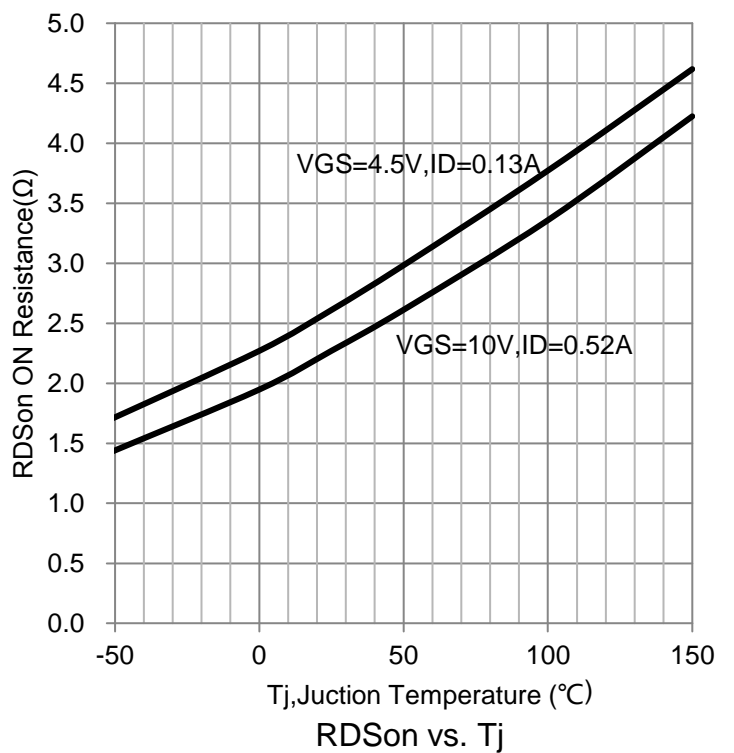
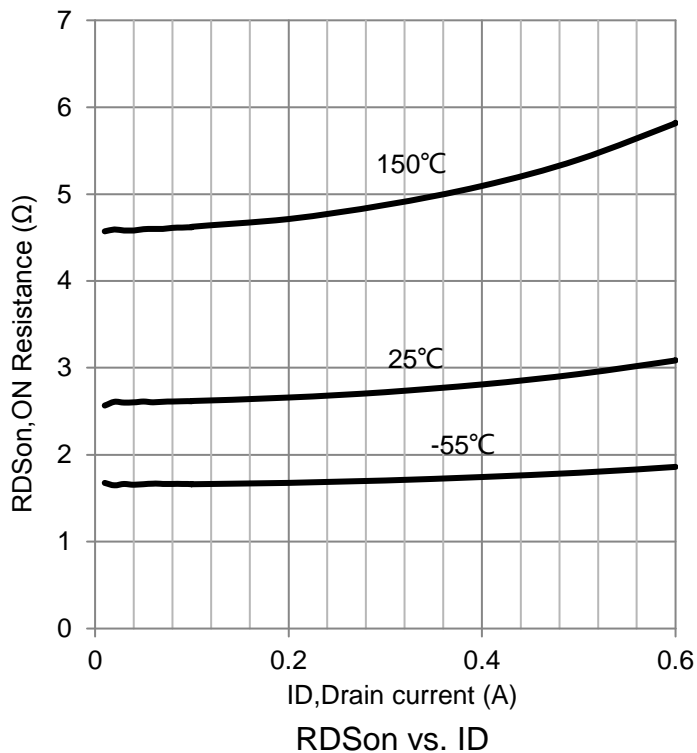
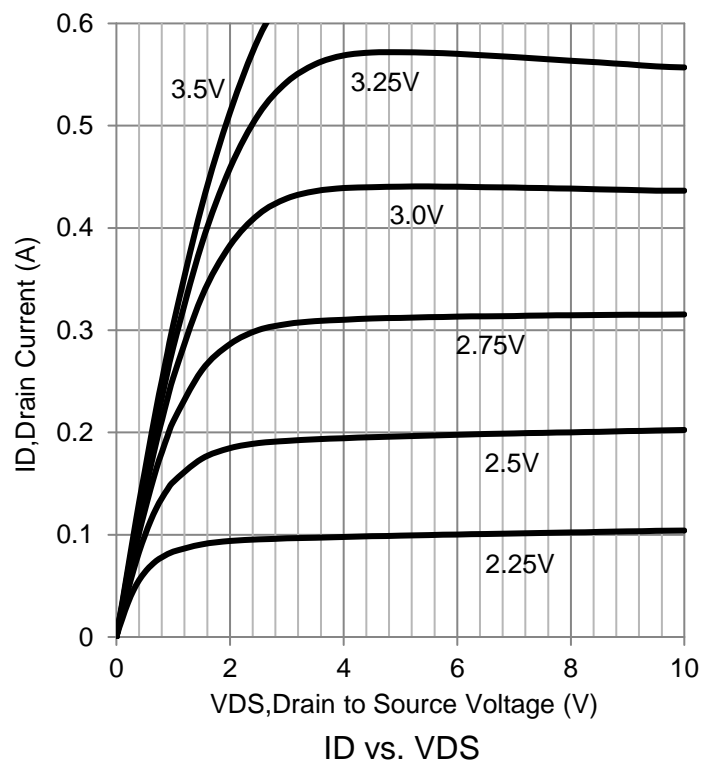
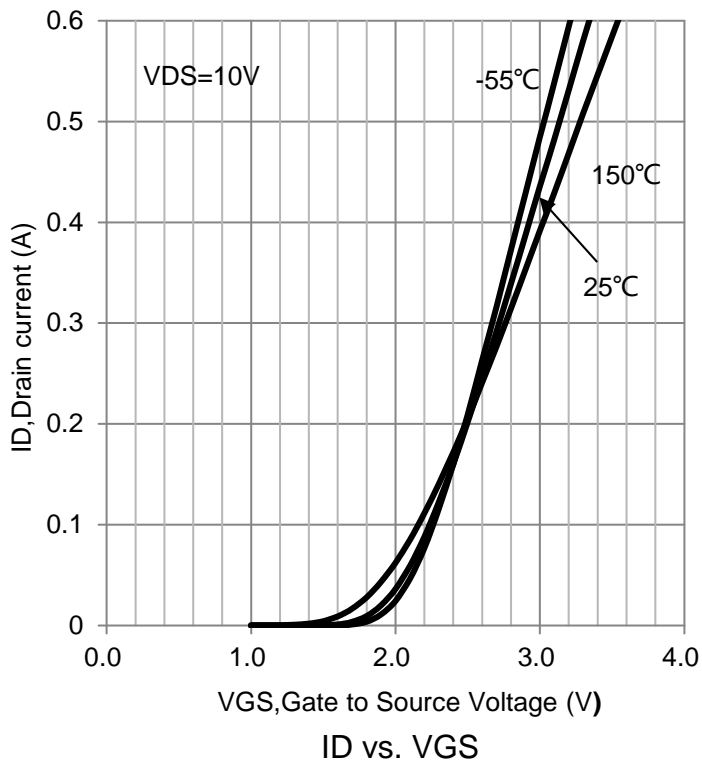

7.ELECTRICAL CHARACTERISTICS CURVES(Con.)

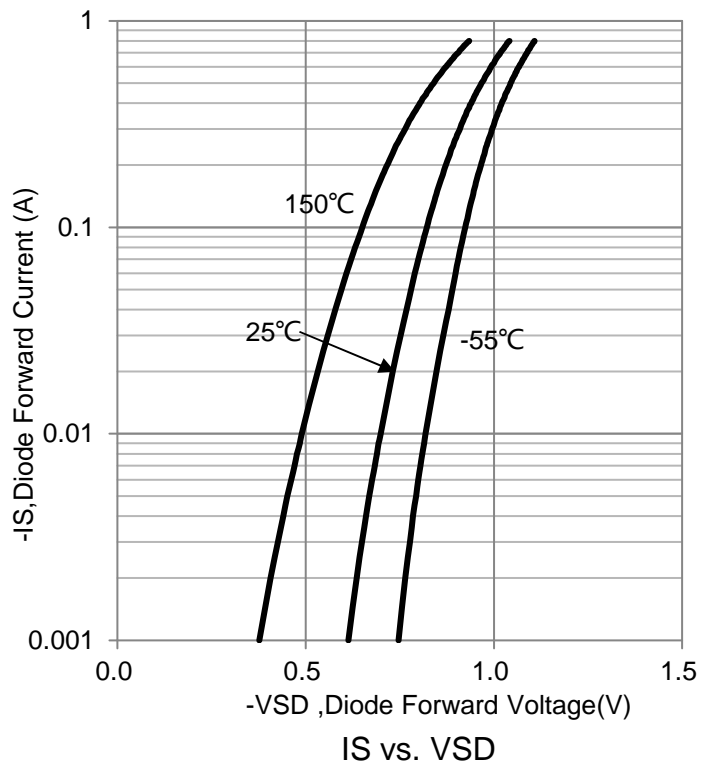
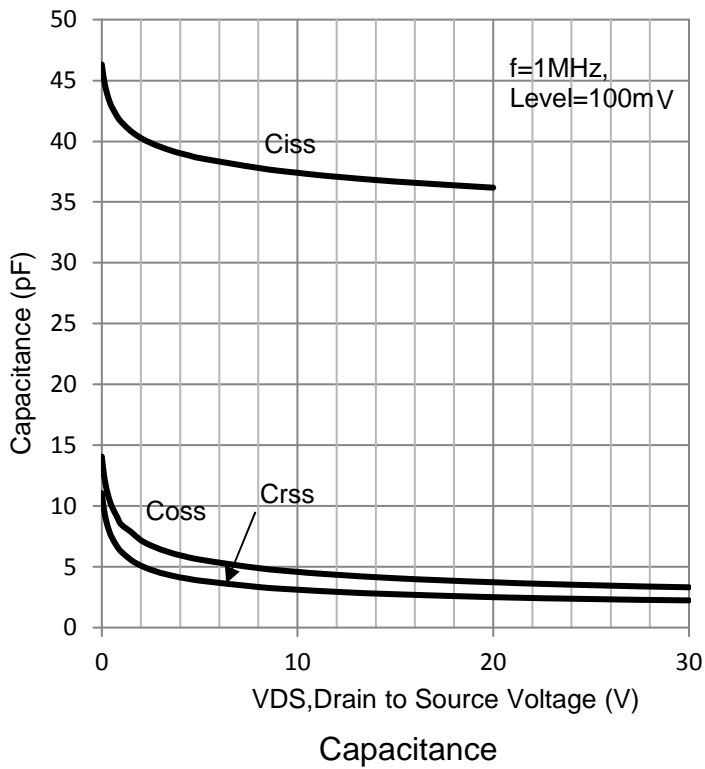

8. OUTLINE AND DIMENSIONS

Notes:

1. DIMENSIONING AND TOLERANCING PER ANSI Y14.5M, 1982.
2. CONTROLLING DIMENSION: MILLIMETERS.
3. MAXIMUM LEAD THICKNESS INCLUDES LEAD FINISH. MINIMUM LEAD THICKNESS IS THE MINIMUM THICKNESS OF BASE MATERIAL.
4. DIMENSIONS D AND E DO NOT INCLUDE MOLD FLASH, PROTRUSIONS OR GATE BURRS.

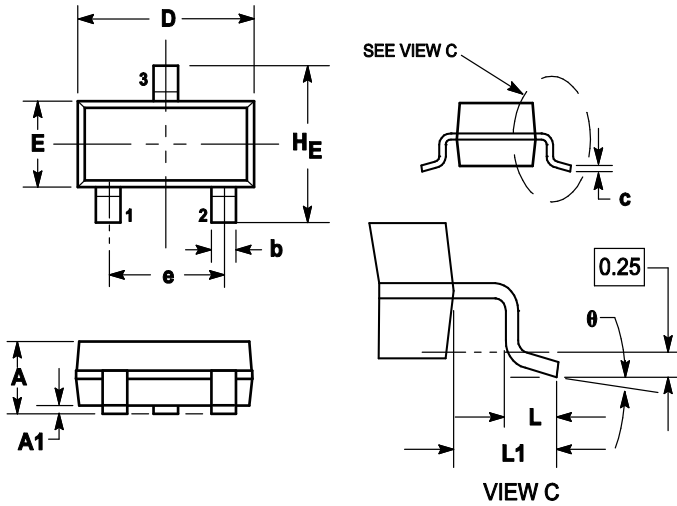

DIM	MILLIMETERS			INCHES		
	MIN	NOM	MAX	MIN	NOM	MAX
A	0.89	1	1.11	0.035	0.04	0.044
A1	0.01	0.06	0.1	0.001	0.002	0.004
b	0.37	0.44	0.5	0.015	0.018	0.02
c	0.09	0.13	0.18	0.003	0.005	0.007
D	2.80	2.9	3.04	0.11	0.114	0.12
E	1.20	1.3	1.4	0.047	0.051	0.055
e	1.78	1.9	2.04	0.07	0.075	0.081
L	0.10	0.2	0.3	0.004	0.008	0.012
L1	0.35	0.54	0.69	0.014	0.021	0.029
HE	2.10	2.4	2.64	0.083	0.094	0.104
θ	0°	---	10°	0°	---	10°

9. SOLDERING FOOTPRINT

