

AT3 25-48/50-4

Autotransformer

- Common input and output windings. The output has no separation to the line voltage
- Insulation class F
- Reverse operation possible

Auto Matching Transformer to IEC 61558-2-13, DIN EN 61558-2-13, VDE 0570 part 2-13, or VDE 0532, UL 506, CSA 22.2

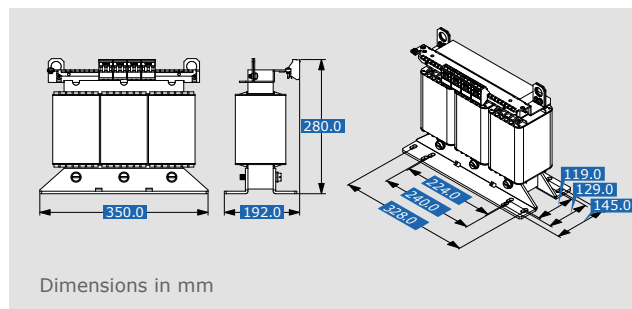

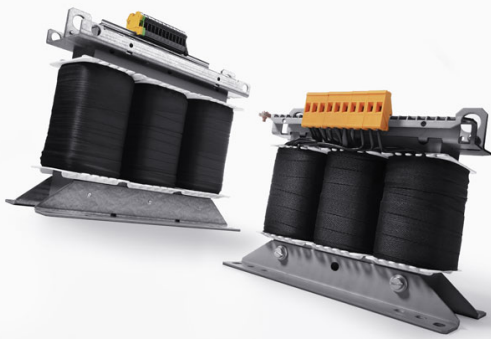

AT3 25-48/50-4

Autotransformer



Input data	
Input voltage	3x480/500 V
Frequency range	50 - 60 Hz
Output data	
Output voltage	3 x 400 V
Efficiency	95 %
Power	25000 VA
Standards and security	
Approvals	C-UL-US
Short circuit strength	non-short-circuit proof
Protection index	IP 00
Safety class (prepared)	I
Ambient temperature max.	40 °C
Class of Insulation System	F
Test voltage	4000 V, 50 Hz
General data	
Vector group	YNaO
Mechanical data	
Type	open type
Core	3 UI 150/77
Terminals	screw type terminals
Fixing method	mounting brackets
Wide	352 mm
Fixing screws	M8
Weight	44.00 kg
Order numbers	
Order Number	AT3 25-48/50-4

BLOCK Transformatoren-Elektronik GmbH

Max-Planck-Straße 36-46

27283 Verden

Germany

Phone +49 4231 678-0

Fax +49 4231 678-177