



EV172A-S-00A

Universal Input, Non-Isolated Offline Regulator with Improved EMI Performance Evaluation Board

DESCRIPTION

The EV172A-S-00A evaluation board is designed to demonstrate the capabilities of the MP172A. The MP172A is a primary-side constant voltage regulator that provides accurate constant voltage (CV) regulation without an optocoupler. It supports buck, buck-boost, boost, and flyback topologies.

The EV172A-S-00A evaluation board is designed for buck applications. It typically drives a 5V/120mA load from an 85VAC to 265VAC input.

The EV172A-S-00A has excellent efficiency and meets IEC 61000-4-5 Class 3 (2kV) surge immunity and EN 55022 conducted EMI requirements. The MP172A offers improved radiation emission performance when compared to the MP172. The MP172A features various protections such as thermal shutdown (TSD), VCC under-voltage lockout (UVLO), overload protection (OLP), short-circuit protection (SCP), and open loop detection.

The MP172A is available in TSOT23-5 and SOIC-8 packages.

ELECTRICAL SPECIFICATIONS

Parameter	Symbol	Value	Units
Input voltage	V_{IN}	85 to 265	VAC
Output voltage	V_{OUT}	5	V
Output current	I_{OUT}	120	mA

FEATURES

- Primary-Side, Non-Isolated CV Control
- Integrated 700V MOSFET
- <100mW No-Load Power Consumption
- Good EMI Performance
- Limited Maximum Frequency
- Multiple Protections: SCP, OLP, Open Loop Detection, TSD, and VCC UVLO
- Low Cost and Simple External Circuit

APPLICATIONS

- Home Appliances, White Goods, and Consumer Electronics
- Industrial Controls
- Standby Power

All MPS parts are lead-free, halogen-free, and adhere to the RoHS directive. For MPS green status, please visit the MPS website under Quality Assurance. "MPS," the MPS logo, and "Simple, Easy Solutions" are registered trademarks of Monolithic Power Systems, Inc. or its subsidiaries.



High Voltage

Warning: Although this board is designed to satisfy safety requirements, the engineering prototype has not been agency approved. Therefore, all testing should be performed using an isolation transformer to provide the AC input to the prototype board.

EV172A-S-00A EVALUATION BOARD

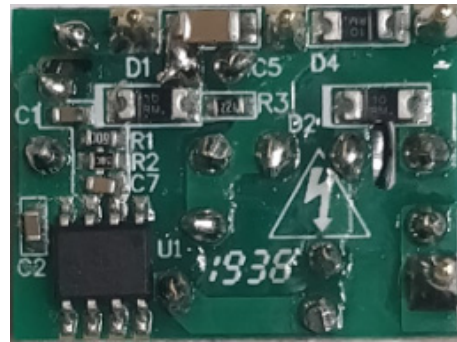

(LxWxH) 17mmx23mmx17mm

Board Number	MPS IC Number
EV172A-S-00A	MP172AGS

QUICK START GUIDE

1. Preset the power supply (V_{IN}) between 85VAC and 265VAC.
2. Turn the power supply off.
3. Connect the line and neutral terminals of the power supply to the L and N ports, respectively.
4. Connect the load's positive and negative terminals to the positive and negative outputs, respectively.
5. Turn on the power supply after making the connections.

EVALUATION BOARD SCHEMATIC

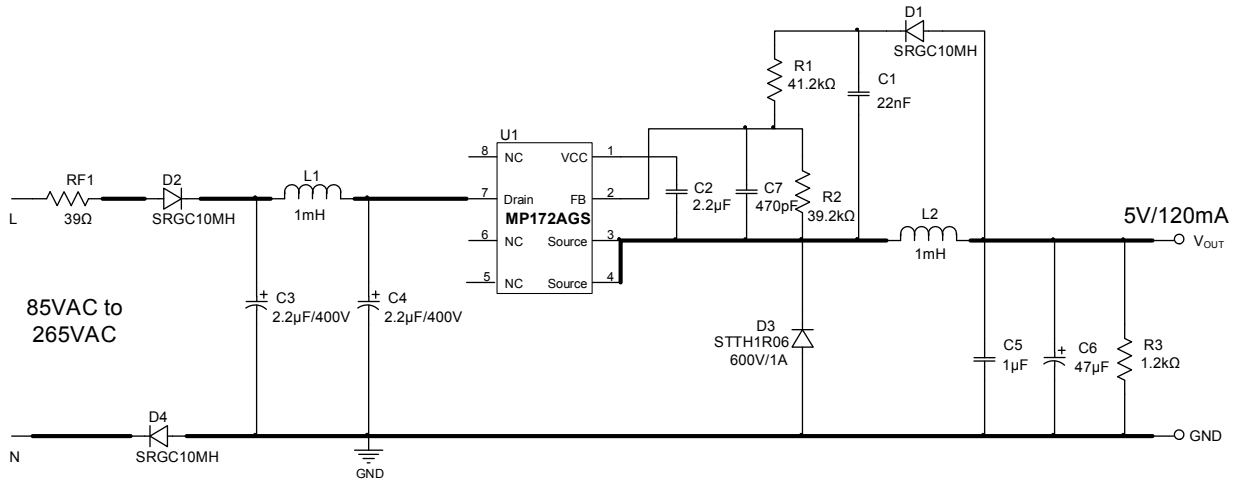

Figure 1: Evaluation Board Schematic

CIRCUIT DESCRIPTION

The EV172A-S-00A is configured in a buck topology to demonstrate the performance of the MP172A. The MP172A is a primary-side regulator that provides accurate constant voltage. It simplifies the schematic and minimizes BOM cost.

RF1 protects the circuit from component failure and excessive short events. It also restrains the inrush current.

C3, L1, and C4 are part of the CLC filter, which meets EN 55022 conducted EMI standards. C3 and C4 provide energy storage and protect against line surges.

With RF1, C3, and C4, the EV172A-J-00A meets standard IEC 61000-4-5 Class 3 (2kV) surge immunity.

C1 is the sample-hold capacitor that reflects output voltage. R1 and R2 are resistor dividers that detect the output voltage by sampling the voltage on C1.

D3 is the freewheeling diode. For universal voltage applications, use a diode with a 600V reverse block voltage. It is recommended to use fast-recovery diodes or ultrafast diodes for improved efficiency and reliable operation.

C6 is the output capacitor for a 5V output. R3 is a dummy load that lowers the output voltage under a no-load condition.

BILL OF MATERIALS

Qty	Ref	Value	Description	Package	Manufacture	Manufacturer PN
1	C1	22nF	Ceramic capacitor, 16V, X7R	0603	muRata	GRM188R71C223KA01D
1	C2	2.2μF	Ceramic capacitor, 10V, X7R	0603	muRata	GRM188R71A225KE15D
2	C3, C4	2.2μF	Electrolytic capacitor, 400V	DIP	Rubycon	400LLE2R2MEFC
1	C5	1μF	Ceramic capacitor, 25V, X7R	1206	muRata	GRM31MR71E105KA01
1	C6	47μF	Electrolytic capacitor, 25V	DIP	Jianghai	CD28L-25V47
1	C7	470pF	Ceramic capacitor, 50V, X7R	0603	muRata	GRM188R71H471KA01D
3	D1, D2, D4	SRGC10MH	Diode, 1000V, 1A	1206	Maxmega	SRGC10MH
1	D3	STTH1R06	Diode, 600V, 1A	DO-41	ST	STTH1R06
1	L1	1mH	Inductor, 17.4Ω, 100mA	DIP	Any	CKL0410-102
1	L2	1mH	Inductor, 6Ω, 250mA	DIP	Wurth	7447462102
1	R1	41.2kΩ	Film resistor, 1%	0603	Yageo	RC0603FR-0741K2L
1	R2	39.2kΩ	Film resistor, 1%	0603	Yageo	RC0603FR-0739K2L
1	R3	1.2kΩ	Film resistor, 1%	0603	Yageo	RC0603FR-071K2L
1	RF1	39Ω	Fuse resistor, 5%, 1W	DIP	Yageo	FKN1WSJT-52-39R
1	U1	MP172A	Buck regulator	SOIC-8	MPS	MP172AGS

EVB TEST RESULTS

Performance waveforms are tested on the evaluation board. $V_{IN} = 230VAC$, $V_{OUT} = 5V$, $I_{OUT} = 120mA$, $T_A = 26^{\circ}C$, unless otherwise noted.

Thermal
 $V_{IN} = 85VAC$

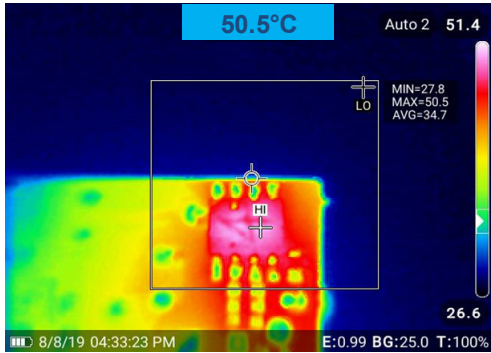

Thermal
 $V_{IN} = 265VAC$

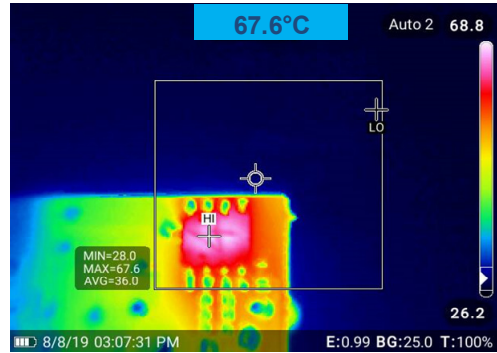

CE Performance
L-line

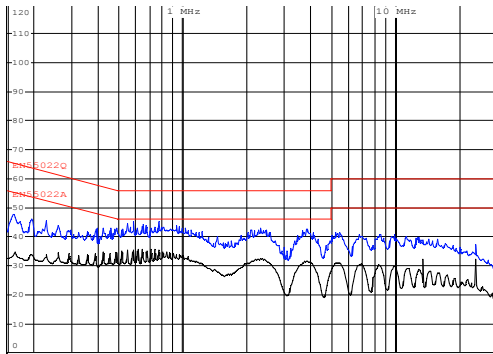

CE Performance
N-line

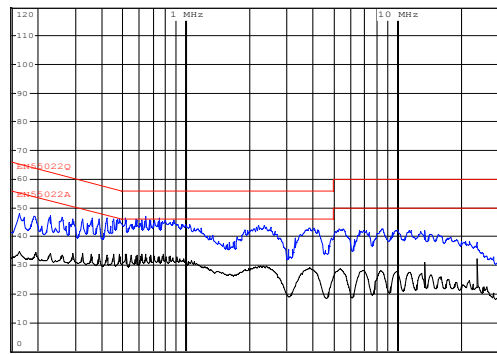

RE Performance
Horizontal (peak)

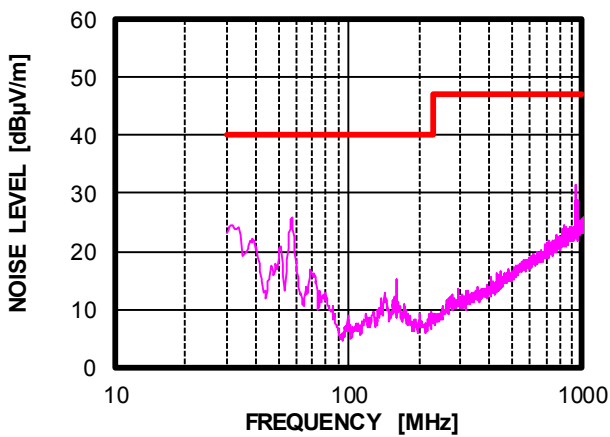

RE Performance
Vertical (peak)

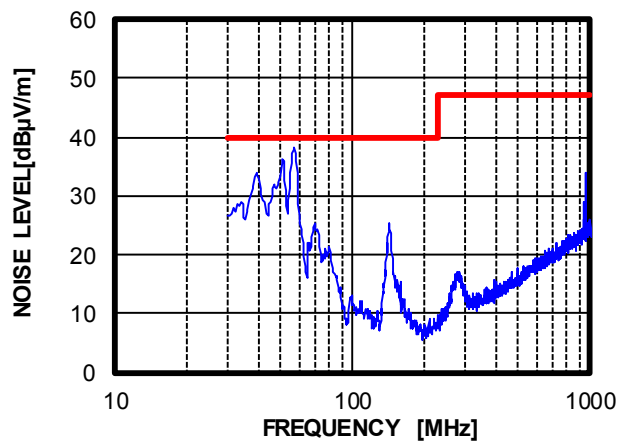

EVB TEST RESULTS (continued)

Performance waveforms are tested on the evaluation board. $V_{IN} = 230VAC$, $V_{OUT} = 5V$, $I_{OUT} = 120mA$, $T_A = 26^{\circ}C$, unless otherwise noted.

Load Regulation

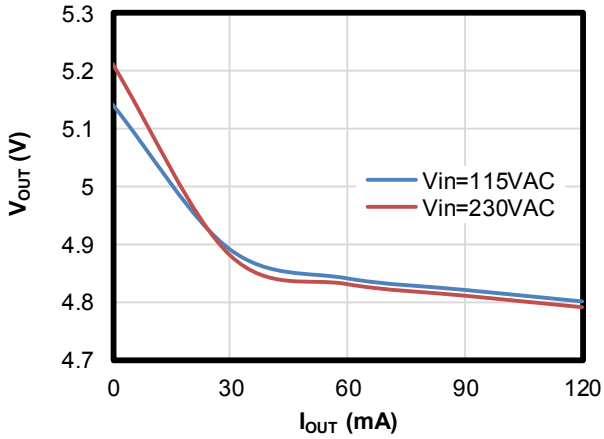

No-Load Consumption

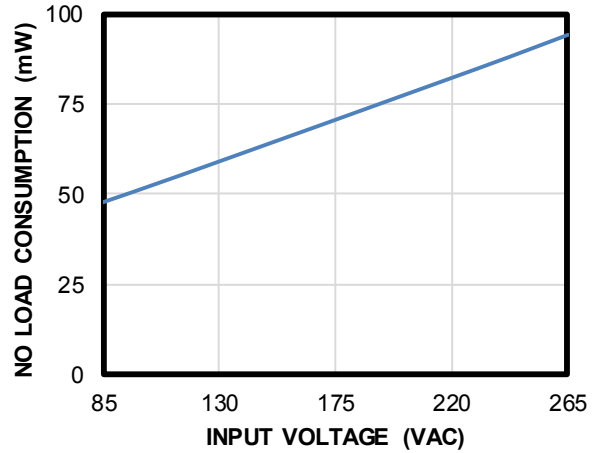

Efficiency

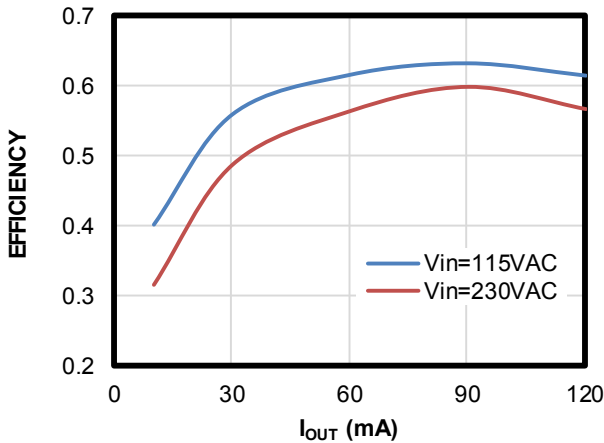

EVB TEST RESULTS *(continued)*

Performance waveforms are tested on the evaluation board. $V_{IN} = 230VAC$, $V_{OUT} = 5V$, $I_{OUT} = 120mA$, $T_A = 26^{\circ}C$, unless otherwise noted.

Steady State

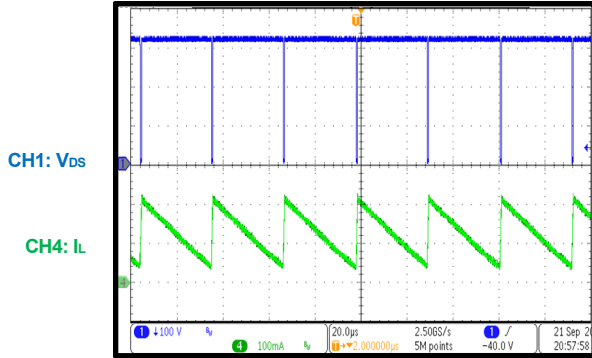

Output Ripple

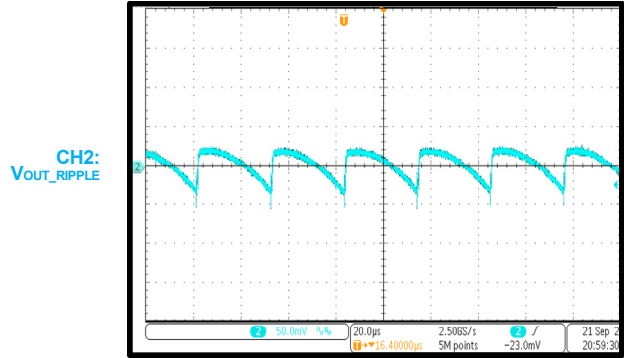

Start-Up

$V_{IN} = 265VAC$, $C_{OUT} = 470\mu F$

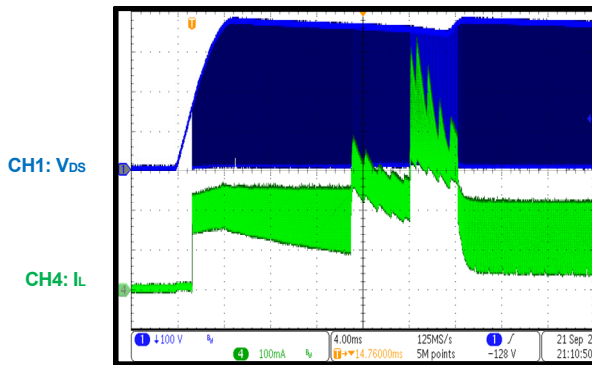

Shutdown

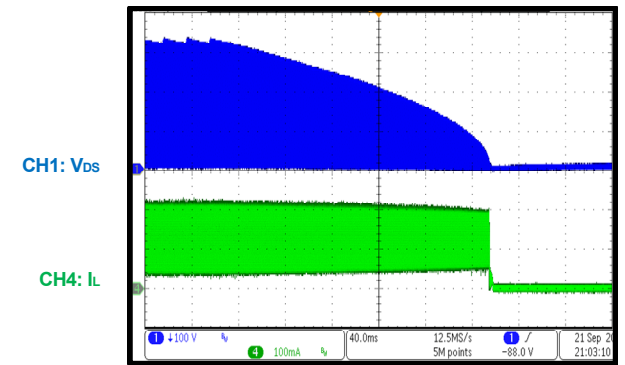

Load Transient

Half-load to full load

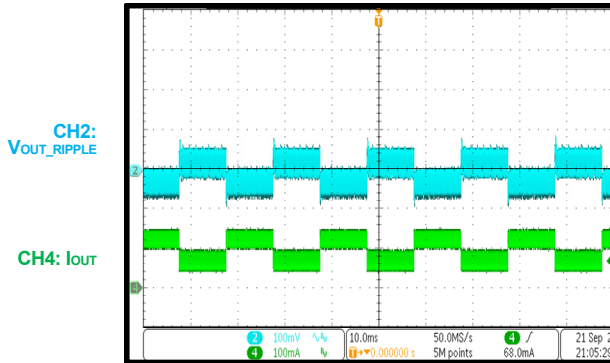

Short-Circuit Protection (SCP) Entry and Recovery

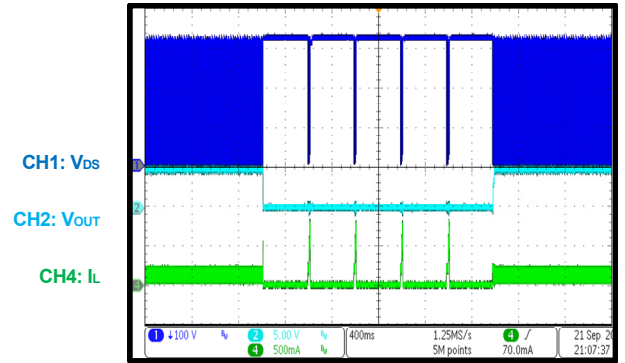

EVB TEST RESULTS *(continued)*

Performance waveforms are tested on the evaluation board. $V_{IN} = 230VAC$, $V_{OUT} = 5V$, $I_{OUT} = 120mA$, $T_A = 26^{\circ}C$, unless otherwise noted.

Open Loop Entry and Recovery

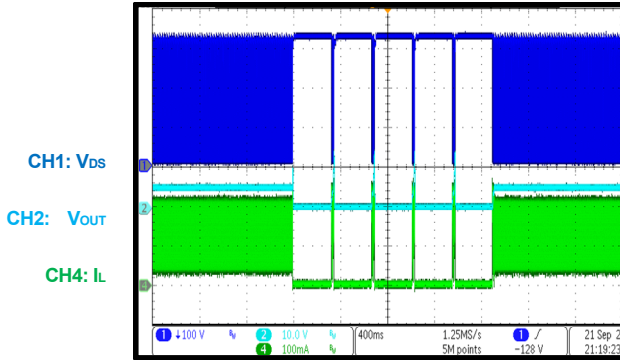

Over-Temperature Protection (OTP) Entry and Recovery

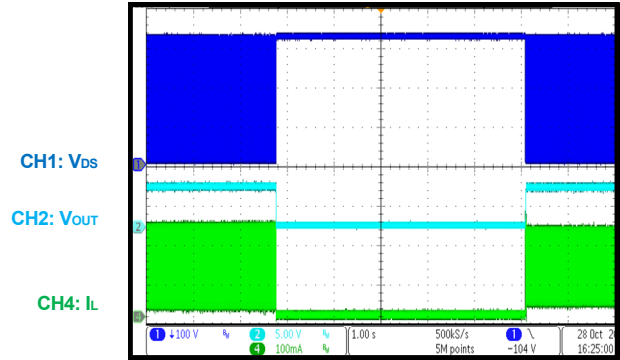

PCB LAYOUT (SINGLE-SIDED)

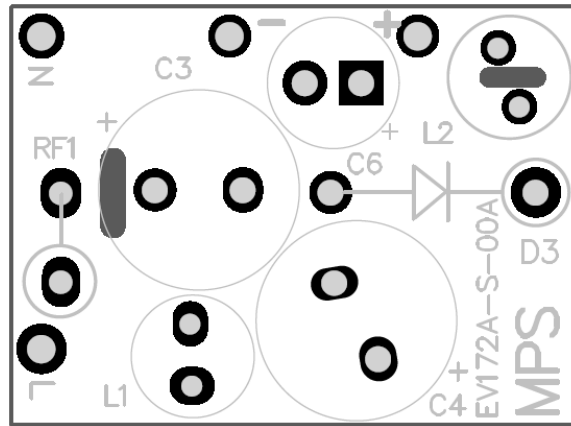

Figure 2: Top Layer

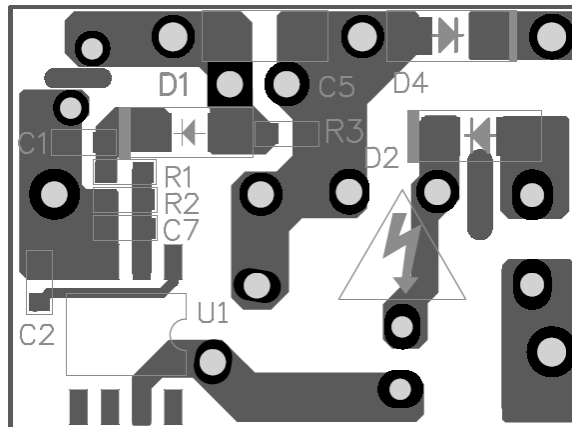

Figure 3: Bottom Layer

Notice: The information in this document is subject to change without notice. Please contact MPS for current specifications. Users should warrant and guarantee that third-party Intellectual Property rights are not infringed upon when integrating MPS products into any application. MPS will not assume any legal responsibility for any said applications.