

IDMD-24-D-12.00-G

(2.54 mm) .100"

SLIM BODY FLAT RIBBON IDC CABLES

SPECIFICATIONS

For complete specifications see www.samtec.com?IDSS, www.samtec.com?IDSD, www.samtec.com?IDMS or www.samtec.com?IDMD

Insulator Material:

Black Glass Filled Polyester

Plating:

Au over 50 μ" (1.27 μm) Ni or Sn over 100 μ" (2.54 μm) Cu or 50 μ" (1.27 μm) Ni

Wire:

28 AWG 7/36 stranded Tinned Copper

Temperature Range:

-20 °C to +105 °C (Rainbow Cable)

-40 °C to +105 °C (Gray Cable)

Voltage Rating:

425 VAC/600 VDC

Contact (IDSS/IDSD):

BeCu

Terminal (IDMS/IDMD):

Phosphor Bronze

Current Rating (IDSD/TST):

3.4 A per pin

(2 pins powered)

Current Rating (IDMD):

3 A per pin

(2 pins powered)

Lead Size Range:

(0.56 mm) .022" SQ to (0.71 mm) .028" SQ

Lead Insertion Depth:

(5.59 mm) .220" to (6.22 mm) .245"

RoHS Compliant:

Yes

Mates with:

TSW, MTSW, TSM, EJH, PHT, HMTSW, HTSW, HW, DW, EW, ZW, MTLW

IDSD Mates with:

TST, HTST, ZST, BST, EJH

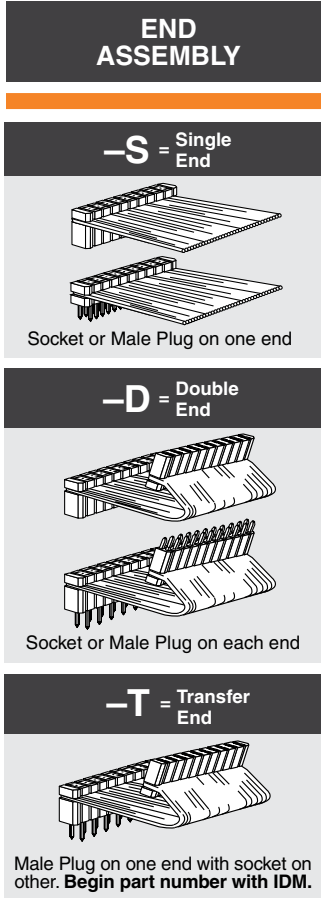
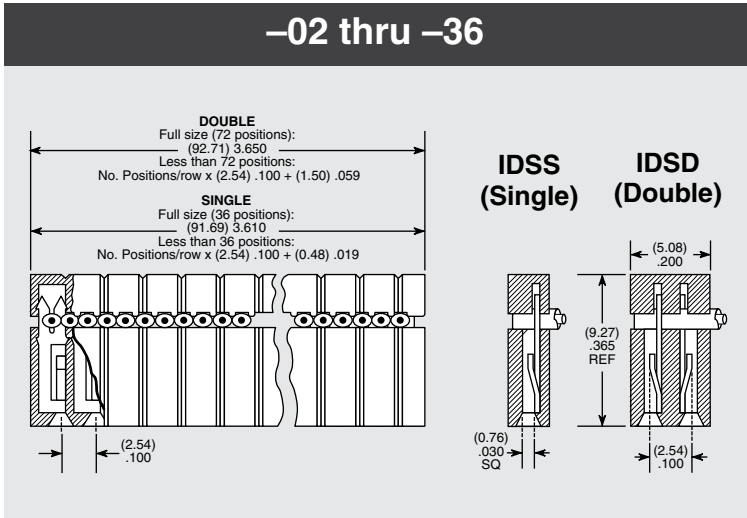
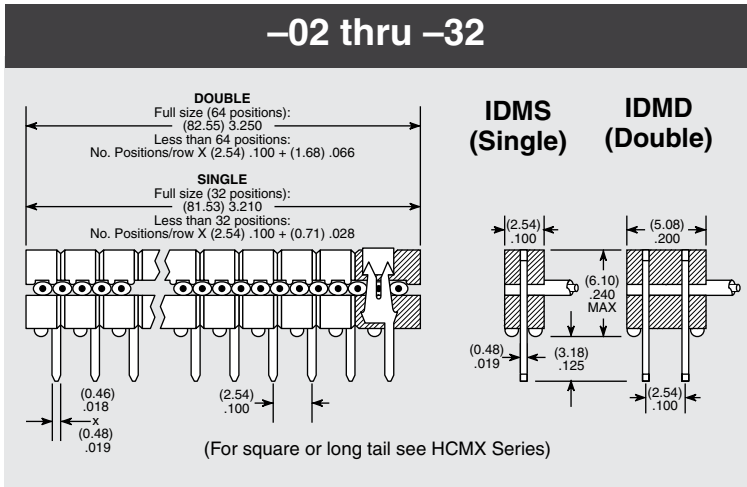
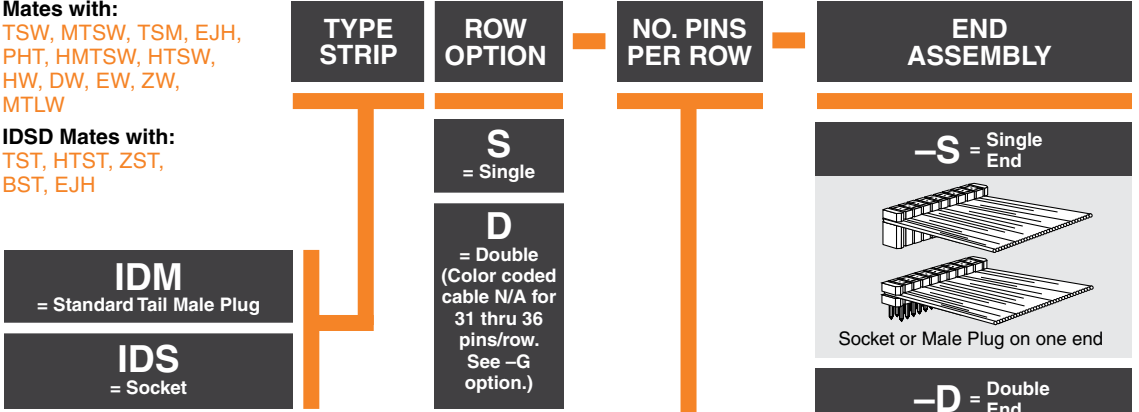

OTHER SOLUTIONS

Molded-To-Position IDC Assemblies

- Low profile
- Skinny side locks
- Dual beam contacts
- Single and double row
- (3.05 mm) .120" and (5.84 mm) .230" length tail available

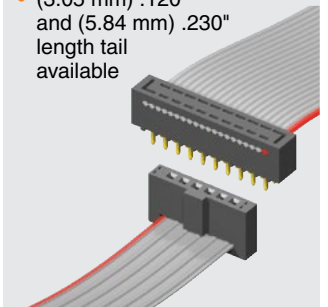

RECOGNITIONS

For complete scope of recognitions see www.samtec.com/quality



Note:
This Series is non-standard, non-returnable.

Due to technical progress, all designs, specifications and components are subject to change without notice.

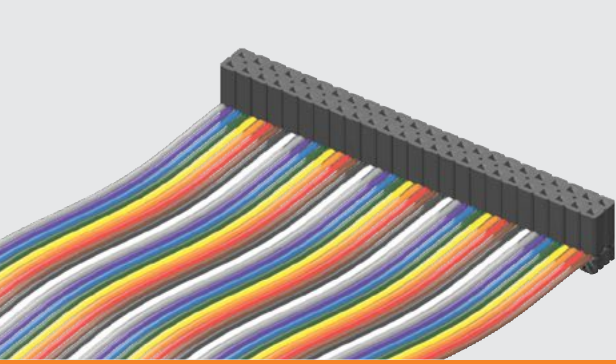

IDSD-24-S-05.00

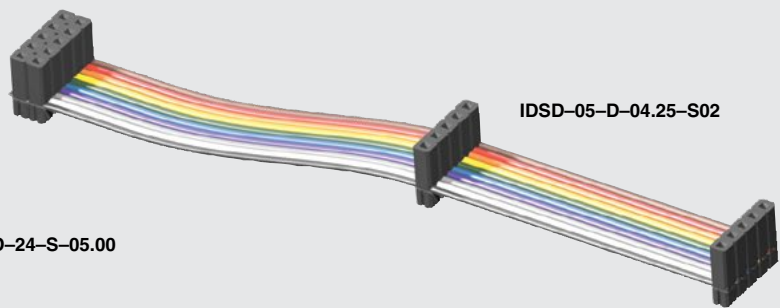

IDSD-05-D-04.25-S02

IDSS, IDSD, IDMS, IDMD SERIES

ASSEMBLED LENGTH

— “XX.XX”
= Assembled Length

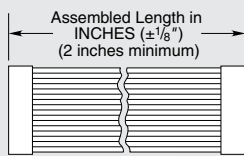

OPTION

POLARIZING KEY

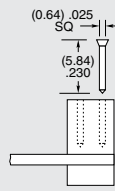

Optional polarizing key for use with IDSS & IDSD Series. Also polarizes SSW, SSQ, ESW & ESQ Series. Black High Temperature Thermoplastic

Order: Part Number PK-01-06
(Available in wheels of six each)

EJECTOR HEADERS & LOCKING CLIPS

RUGGEDIZED
— BY SAMTEC —

- Ejector headers
- Locking clips

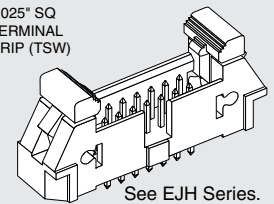
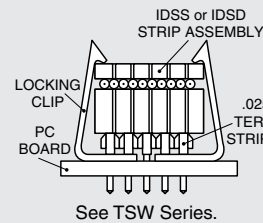

—T = Tin Plating (Both ends)

—C = Tin IDM = 10 μ " (0.25 μ m) Gold IDS (-T End Assembly Required)

—A = 10 μ " (0.25 μ m) Gold IDM = Tin IDS (-T End Assembly Required)

Standard plating is selective gold over BeCu contact for IDS; Selective gold over phosphor bronze for IDM.

1

—ST “X”
= Stripped & Tinned

Specify Suffix from table. All dimensions are $\pm 1/16"$. Not available in 28 positions and higher.

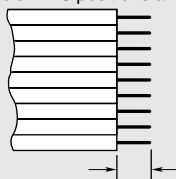

4

—S “XX”
= Daisy Chain Single

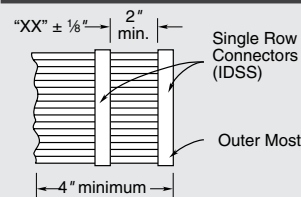

When mating double row connector with two single row connectors, the outer most single will be connected to Conductor #1 and the inside single to Conductor #2.

7

—R
= Reversed

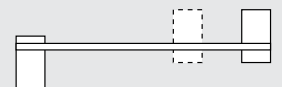

8

—P “XX”
= Polarized

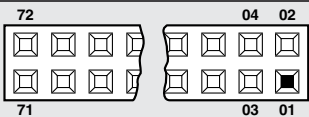

Specify “XX” as position. For Double the same position will be polarized on both ends. (Not available on IDM unless transfer, then only the socket is polarized.)

2

—G
= Gray Cable

Specify -G for Gray cable. Gray cable has one red edge. IDSS and IDMS uses .100" centerline cable. IDSD and IDMD uses .050" centerline cable. Cable is 28 AWG 7/36 copper wire. Standard cable is same as above except color coded.

3

—B “XX”
= Breakout

Specify “XX” as number of conductors to be broken out.

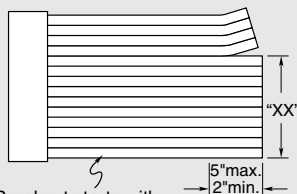

Breakout starts with Number 1 lead indicated by brown wire or red stripe. Shown on top side.

5

—D “XX”
= Daisy Chain, Double

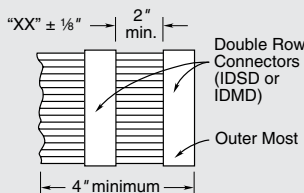

7

—W “XX”
= Wiring Reversed Daisy Chain, Single

Same as -S “XX” except outer strip connected to Conductor #2 and inside strip connected to Conductor #1.

7

—M
= Middle Reversed

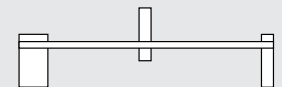

Requires -SXX, -WXX or -DXX

8

—O
= Outside Reversed

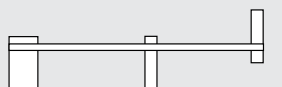

Requires -SXX, -WXX or -DXX

8

—RW
= Reversed Wiring

#1 wire opposite position #1.

6

Due to technical progress, all designs, specifications and components are subject to change without notice.

WWW.SAMTEC.COM

All parts within this catalog are built to Samtec's specifications.

Customer specific requirements must be approved by Samtec and identified in a Samtec customer-specific drawing to apply.

Mouser Electronics

Authorized Distributor

Click to View Pricing, Inventory, Delivery & Lifecycle Information:

Samtec:

[IDSS-05-S-05.75-T-ST4](#) [IDSS-05-D-09.00](#) [IDSS-16-D-05.00-G](#) [IDSS-03-D-18.00](#) [IDSS-16-D-06.00](#) [IDSS-08-D-05.00-G](#) [IDSS-15-S-03.00-ST8](#) [IDSS-05-D-03.00](#) [IDSS-10-D-09.00-R](#) [IDSS-10-D-16.00](#) [IDSS-10-D-16.00-G](#) [IDSS-10-D-36.00](#) [IDSS-10-S-03.00](#) [IDSS-10-S-03.00-ST4](#) [IDSS-10-S-07.00](#) [IDSS-10-S-30.00](#) [IDSS-10-S-36.00-G](#) [IDSS-10-S-40.00](#) [IDSS-11-D-08.00-G-R](#) [IDSS-11-S-07.00-ST4](#) [IDSS-11-S-08.00-ST8](#) [IDSS-12-D-02.00-P03](#) [IDSS-12-D-04.00-T-G-R](#) [IDSS-12-D-07.00](#) [IDSS-12-D-07.00-T-G](#) [IDSS-12-D-11.00-T-P07-G](#) [IDSS-12-D-120.00-G](#) [IDSS-12-S-02.75-ST8](#) [IDSS-12-S-03.00-ST8](#) [IDSS-12-S-03.50](#) [IDSS-14-D-14.00-B06](#) [IDSS-14-D-24.00-R](#) [IDSS-14-D-30.00-G](#) [IDSS-14-D-32.00](#) [IDSS-14-S-03.00-T-ST8](#) [IDSS-14-S-03.75-ST8](#) [IDSS-14-S-06.00-ST8](#) [IDSS-14-S-10.00-G-ST8](#) [IDSS-14-S-12.00-G-ST8](#) [IDSS-06-S-12.00](#) [IDSS-06-S-21.00-ST4-RW](#) [IDSS-06-S-24.00](#) [IDSS-07-D-07.00-G](#) [IDSS-07-D-18.00-T](#) [IDSS-07-S-02.00-ST8](#) [IDSS-07-S-02.30-G-ST4](#) [IDSS-07-S-05.00](#) [IDSS-07-S-17.00](#) [IDSS-07-S-24.00](#) [IDSS-08-D-02.30](#) [IDSS-08-D-02.50-G](#) [IDSS-08-D-06.00-T-G](#) [IDSS-08-D-06.50](#) [IDSS-08-D-10.00-G](#) [IDSS-08-D-10.00-G-R](#) [IDSS-08-D-13.00-G](#) [IDSS-08-D-22.50-R](#) [IDSS-08-D-28.00-G-R](#) [IDSS-08-S-03.00-ST4](#) [IDSS-08-S-03.50-G-ST8](#) [IDSS-08-S-05.00-T-ST4](#) [IDSS-08-S-06.00](#) [IDSS-08-S-06.00-ST2](#) [IDSS-08-S-10.00-G](#) [IDSS-08-S-10.00-G-RW](#) [IDSS-08-S-15.00](#) [IDSS-08-S-16.00](#) [IDSS-08-S-16.00-ST4](#) [IDSS-13-D-02.00-G-R](#) [IDSS-13-D-06.00-P06-G](#) [IDSS-13-S-04.00](#) [IDSS-13-S-04.00-G-ST4](#) [IDSS-14-D-02.00-R](#) [IDSS-14-D-02.00-T](#) [IDSS-14-D-02.20-R](#) [IDSS-14-D-03.50-T-G](#) [IDSS-14-D-05.00-T-G](#) [IDSS-14-D-08.00-T](#) [IDSS-14-D-08.00-T-G](#) [IDSS-14-D-08.00-T-R](#) [IDSS-14-D-22.00-G](#) [IDSS-14-D-23.10](#) [IDSS-14-D-45.00-G](#) [IDSS-14-D-46.10-S22](#) [IDSS-14-D-65.00-T-G](#) [IDSS-14-S-04.00-ST8](#) [IDSS-14-S-04.00-T-G-ST8](#) [IDSS-14-S-07.00-G-ST8](#) [IDSS-14-S-10.00-ST4](#) [IDSS-14-S-10.00-T-G-ST8](#) [IDSS-14-S-600.00](#) [IDSS-15-D-05.50](#) [IDSS-09-D-03.00-G-R](#) [IDSS-09-D-07.00](#) [IDSS-09-D-07.00-R](#) [IDSS-09-D-08.00-G](#) [IDSS-09-D-14.00-G](#) [IDSS-09-S-02.625-ST8](#) [IDSS-09-S-06.00-G-ST4](#) [IDSS-09-S-06.00-G-ST8](#)