

AP30H80G

N-Channel Enhancement Mosfet

Feature

- 30V,70A
 $R_{DS(ON)} < 6m\Omega @ V_{GS}=10V$
 $R_{DS(ON)} < 12m\Omega @ V_{GS}=4.5V$
- Advanced Trench Technology
- Lead free product is acquired
- Excellent $R_{DS(ON)}$ and Low Gate Charge

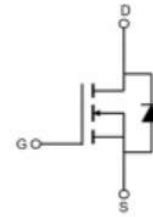

Schematic Diagram

Application

- PWM applications
- Load Switch
- Power management

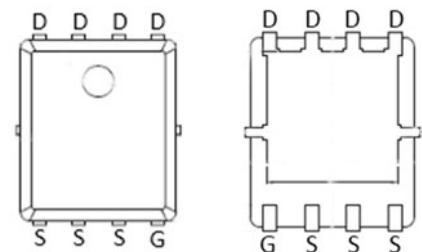

PDFN5X6-8L

Package Marking and Ordering Information

Device Marking	Device	Device Package	Reel Size	Tape width	Quantity (PCS)
30H80G	AP30H80G	PDFN5X6-8L	13 inch	-	5000

ABSOLUTE MAXIMUM RATINGS ($T_a=25^\circ\text{C}$ unless otherwise noted)

Parameter	Symbol	Value	Unit
Drain-Source Voltage	V_{DS}	30	V
Gate-Source Voltage	V_{GS}	± 20	V
Continuous Drain Current ($T_a=25^\circ\text{C}$)	I_D	70	A
Continuous Drain Current ($T_a=100^\circ\text{C}$)	I_D	46	A
Pulsed Drain Current ⁽¹⁾	I_{DM}	280	A
Singel Pulsed Avalanche Energy ⁽²⁾	E_{AS}	56	mJ
Power Dissipation	P_D	65	W
Thermal Resistance from Junction to Ambient	$R_{\theta JA}$	1.92	$^\circ\text{C}/\text{W}$
Junction Temperature	T_J	150	$^\circ\text{C}$
Storage Temperature	T_{STG}	-55~ +150	$^\circ\text{C}$

MOSFET ELECTRICAL CHARACTERISTICS($T_a=25^{\circ}\text{C}$ unless otherwise noted)

Parameter	Symbol	Test Condition	Min	Type	Max	Unit
Static Characteristics						
Drain-source breakdown voltage	$V_{(BR)DSS}$	$V_{GS} = 0V, I_D = 250\mu A$	30	-	-	V
Zero gate voltage drain current	I_{DSS}	$V_{DS} = 30V, V_{GS} = 0V$	-	-	1	μA
Gate-body leakage current	I_{GSS}	$V_{GS} = \pm 20V, V_{DS} = 0V$	-	-	± 100	nA
Gate threshold voltage ⁽³⁾	$V_{GS(th)}$	$V_{DS} = V_{GS}, I_D = 250\mu A$	1	1.5	2.5	V
Drain-source on-resistance ⁽³⁾	$R_{DS(on)}$	$V_{GS} = 10V, I_D = 30A$	-	4.8	6.0	m Ω
		$V_{GS} = 4.5V, I_D = 20A$	-	7.5	12	
Dynamic characteristics						
Input Capacitance	C_{iss}	$V_{DS} = 15V, V_{GS} = 0V, f = 1MHz$	-	1614	-	pF
Output Capacitance	C_{oss}		-	245	-	
Reverse Transfer Capacitance	C_{rss}		-	215	-	
Switching characteristics						
Turn-on delay time	$t_{d(on)}$	$V_{DD} = 15V, I_D = 30A,$ $V_{GS} = 10V, R_G = 3\Omega$	-	7.5	-	ns
Turn-on rise time	t_r		-	14.5	-	
Turn-off delay time	$t_{d(off)}$		-	35.2	-	
Turn-off fall time	t_f		-	9.6	-	
Total Gate Charge	Q_g	$V_{DS} = 15V, I_D = 30A,$ $V_{GS} = 10V$	-	33.7	-	nC
Gate-Source Charge	Q_{gs}		-	8.5	-	
Gate-Drain Charge	Q_{gd}		-	7.5	-	
Source-Drain Diode characteristics						
Diode Forward voltage ⁽³⁾	V_{DS}	$V_{GS} = 0V, I_S = 1A$	-	-	1.2	V
Diode Forward current ⁽⁴⁾	I_S		-	-	70	A

Notes:

1. Repetitive Rating: pulse width limited by maximum junction temperature
2. EAS Condition: $T_J = 25^{\circ}\text{C}, V_{DD} = 15V, R_G = 25\Omega, L = 0.5\text{mH}, I_{AS} = 15A$
3. Pulse Test: pulse width $\leq 300\mu\text{s}$, duty cycle $\leq 2\%$
4. Surface Mounted on FR4 Board, $t \leq 10\text{ sec}$

Typical Performance Characteristics

Figure 1: Output Characteristics

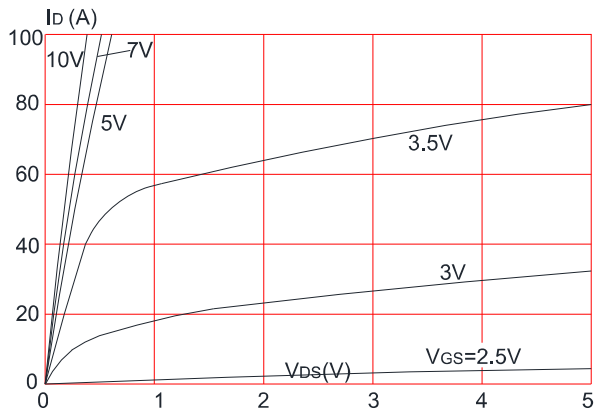

Figure 2: Typical Transfer Characteristics

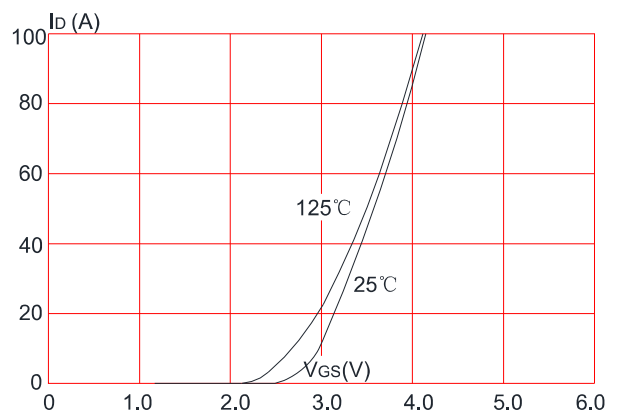

Figure 3: On-resistance vs. Drain Current

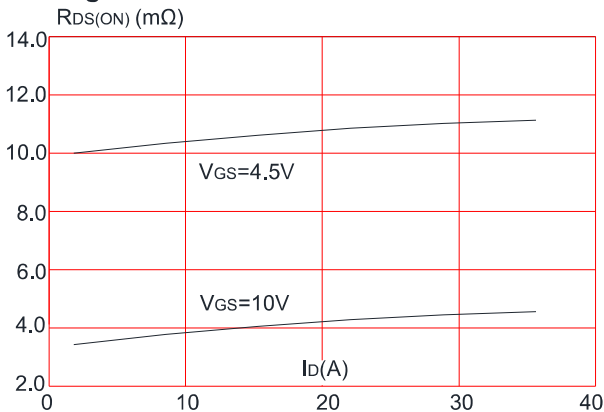

Figure 4: Body Diode Characteristics

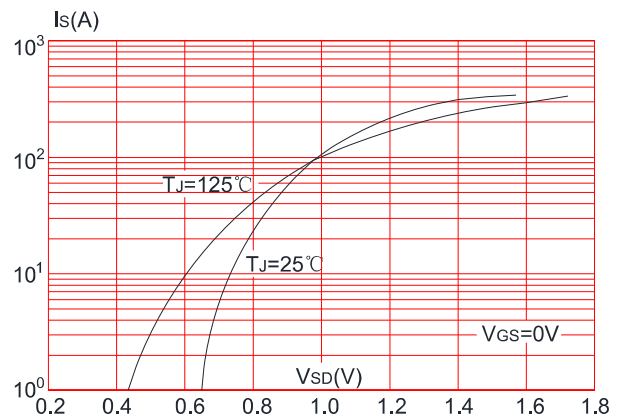

Figure 5: Gate Charge Characteristics

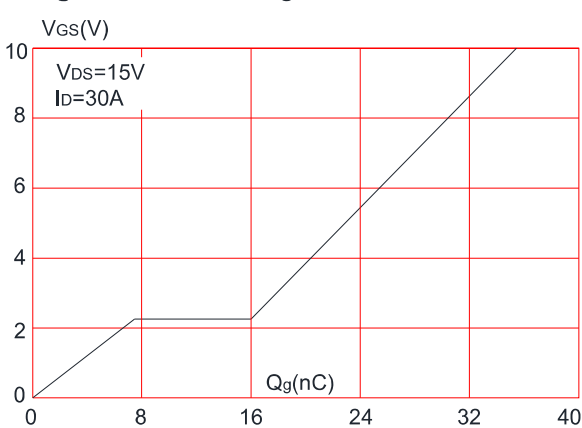

Figure 6: Capacitance Characteristics

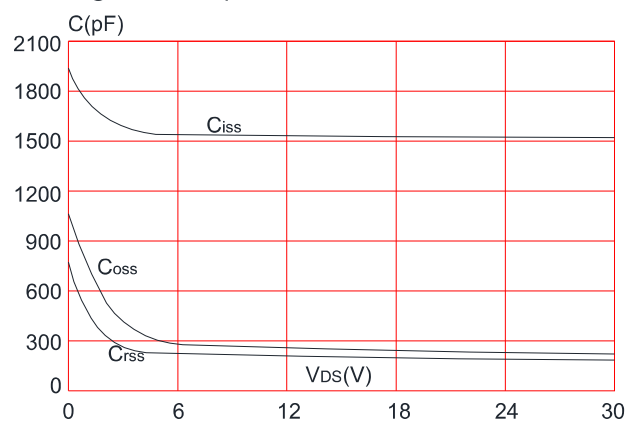

Figure 7: Normalized Breakdown Voltage vs. Junction Temperature

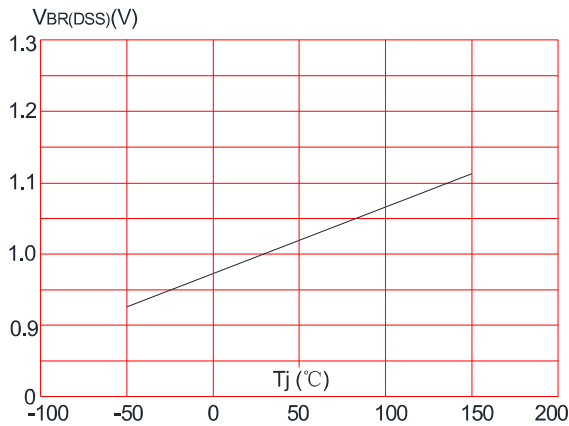

Figure 8: Normalized on Resistance vs. Junction Temperature

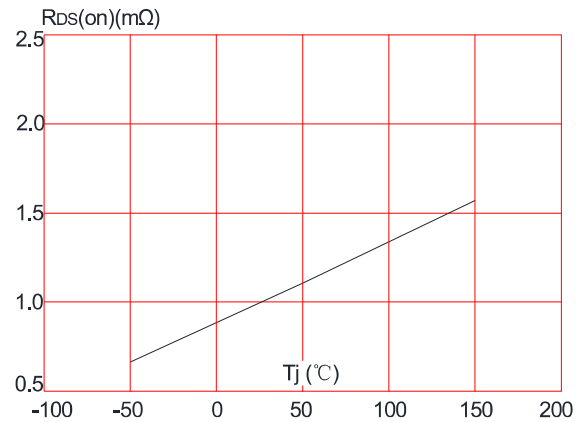

Figure 9: Maximum Safe Operating Area

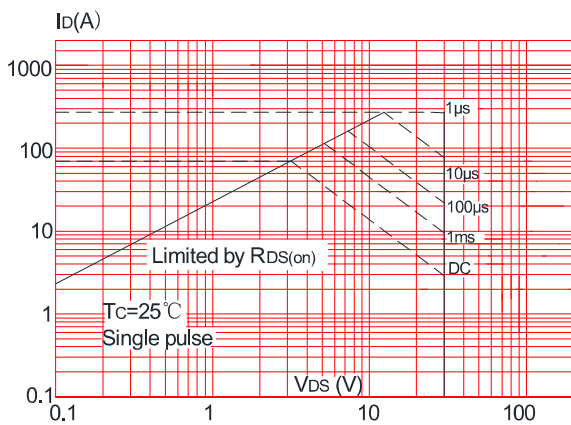

Figure 10: Maximum Continuous Drain Current vs. Case Temperature

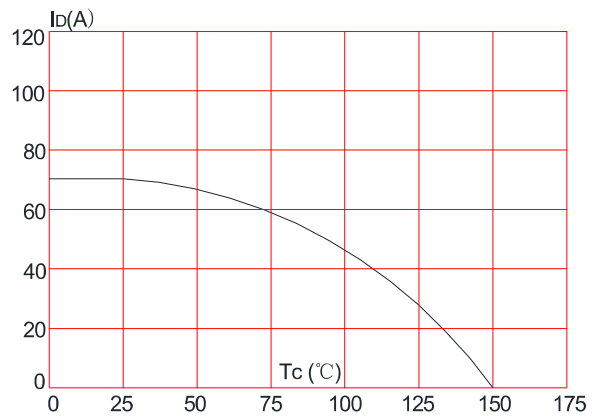
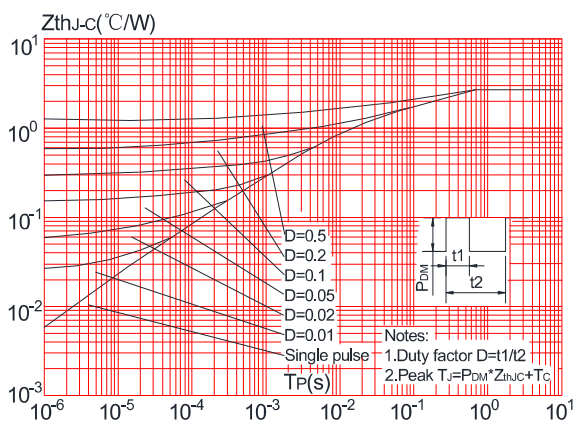

Figure.11: Maximum Effective Transient Thermal Impedance, Junction-to-Case



Test Circuit

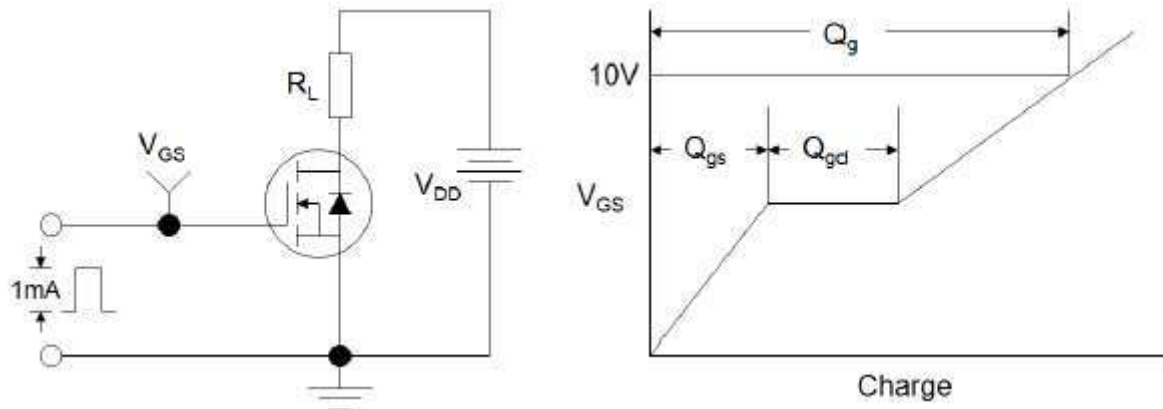

Figure1:Gate Charge Test Circuit & Waveform

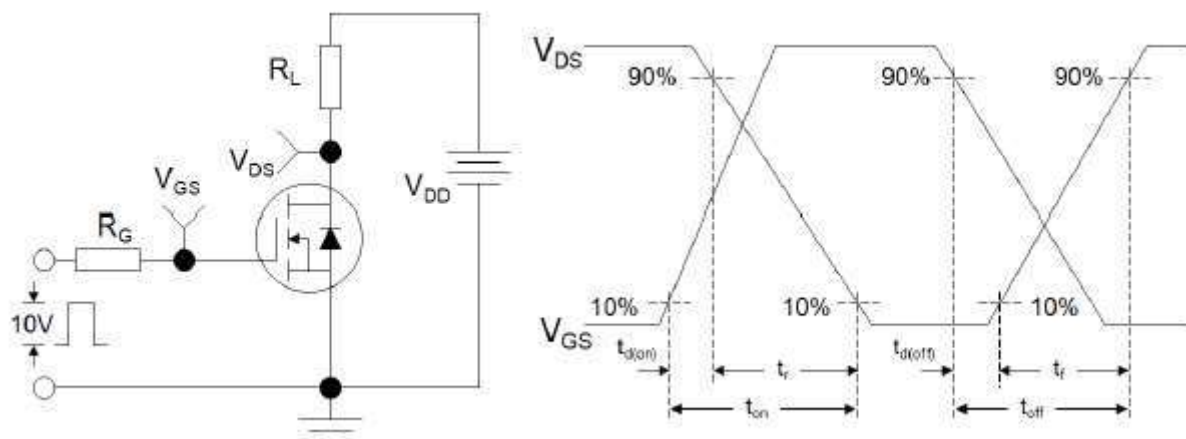

Figure 2: Resistive Switching Test Circuit & Waveforms

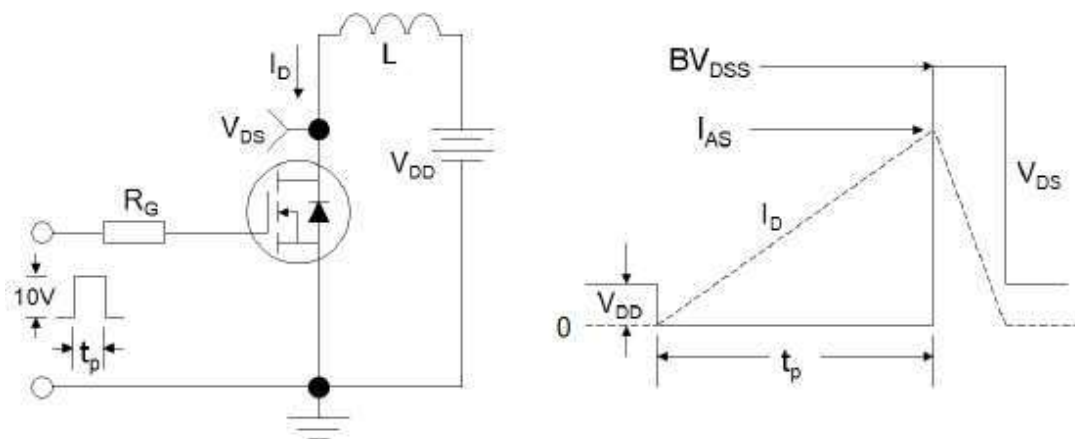
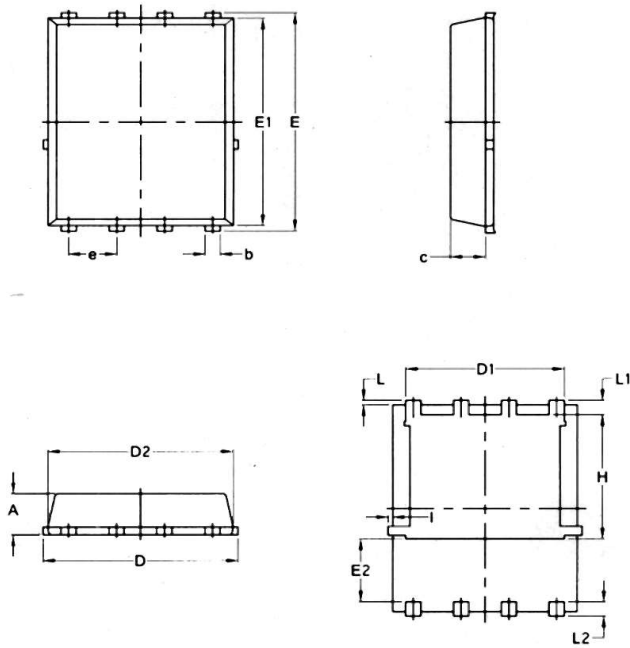

Figure 3:Unclamped Inductive Switching Test Circuit & Waveforms

PDFN5X6-8L Package Information



PDFN5X6-8L

SYMBOL	COMMON			
	MM		INCH	
	MIN.	MAX.	MIN.	MAX.
A	1.03	1.17	0.0406	0.0461
b	0.34	0.48	0.0134	0.0189
c	0.824	0.970	0.0324	0.0382
D	4.80	5.40	0.1890	0.2126
D1	4.11	4.31	0.1618	0.1697
D2	4.80	5.00	0.1890	0.1969
E	5.95	6.15	0.2343	0.2421
E1	5.65	5.85	0.2224	0.2303
E2	1.60	—	0.0630	—
e	1.27 BSC		0.05 BSC	
L	0.05	0.25	0.0020	0.0098
L1	0.38	0.50	0.0150	0.0197
L2	0.38	0.50	0.0150	0.0197
H	3.30	3.50	0.1299	0.1378
I	—	0.18	—	0.0070