

MC42005A6WK-SPTLY-V2	4 x 20	5mm Character Height	LCD Module
<b>Specification</b>			
Version: 1		Date: 13/02/2016	
<b>Revision</b>			
1	11/02/2016	First Issue	

Display Features		
Character Count	4 x 20	
Appearance	Black on Yellow/Green	
Logic Voltage	5V	
Interface	Parallel	
Font Set	English / European	
Display Mode	Transflective	
Character Height	4.75mm	
LC Type	STN	
Module Size	98.00 x 60.00 x 14.00 mm	
Operating Temperature	-20°C ~ +70°C	
Construction	COB	Box Quantity
LED Backlight	Yellow/Green	---
		Weight / Display
		---



**RoHS**  
compliant

\* - For full design functionality, please use this specification in conjunction with the ST7066U + ST7063C specification. (Provided Separately)

Display Accessories	
Part Number	Description
MCCMDB-16SIL	LCD Interconnect board, can be driven from either a PC or a single Board computer with a USB output.
MCCBL1A16SLIP-16DILS-150	16 Way, Single in-line to Dual In-line connector Cable.
MCCBL1A16SLIP-16SILS-150	16 Way, Single in-line to Single In-line connector Cable.

Optional Variants		
Fonts	Appearances	Voltage
English/Japanese English/Cyrillic	White on Blue Black on White Black on RGB	3V 3.3V



## FEATURES

AVAILABLE OPTIONS	CHARACTERISTICS
DISPLAY FORMAT	20 Characters by 4 Lines
POLARIZER OPTIONS	Positive Transflective
BACKLIGHT TYPE OPTIONS	Edge Type LED Backlight (Long life span version)
BACKLIGHT COLOR OPTIONS	Yellow-Green color
LCD PANEL OPTIONS	Yellow-Green STN
VIEWING ANGLE OPTIONS	6:00 ( Bottom )
TEMPERATURE RANGE OPTIONS	-20°C ~ 70°C, Single Supply Voltage
SUGGESTED DRIVING VOLTAGE	V <sub>lcm</sub> = 5.0V V <sub>led</sub> = 5.0V
SUGGESTED LED DRIVING MODE	PIN15: LED+, PIN16:LED-
CONTROLLER	ST7066U + ST7063C
FONT MAP CODE	K Version
DRIVING DUTY	1/16
DRIVING BIAS	1/5

## MECHANICAL SPECIFICATIONS

<b>OVERALL SIZE</b>	98.0W x 60.0H	mm	<b>THICKNESS</b>	max 14.0	mm
<b>VIEWING AREA</b>	76.0W x 26.0H	mm	<b>HOLE-HOLE</b>	93.0W x 55.0H	mm
<b>CHARACTER SIZE</b>	2.95W x 4.75H	mm	<b>CHARACTER PITCH</b>	0.60W x 0.60H	mm
<b>DOT SIZE</b>	0.55W x 0.55H	mm	<b>DOT PITCH</b>	0.05W x 0.05H	mm

## ABSOLUTE MAXIMUM RATINGS

ITEM	SYMBOL	CONDITION	MIN	TYP	MAX	UNIT
POWER SUPPLY ( LOGIC)	V <sub>dd</sub>	25°C	-0.3	—	7.0	V
POWER SUPPLY (LCD)	V <sub>0</sub>	25°C	V <sub>dd</sub> -13.5	—	V <sub>dd</sub> +0.3	V
INPUT VOLTAGE	V <sub>in</sub>	25°C	-0.3	—	V <sub>dd</sub> +0.3	V
OPERATING TEMPERATURE	V <sub>opr</sub>	—	-20	—	70	°C
STORAGE TEMPERATURE	V <sub>stg</sub>	—	-30	—	80	°C

## ELECTRONIC CHARACTERISTICS \*

	ITEM	SYMBOL	CONDITION	MIN	TYP	MAX	UNIT
	INPUT VOLTAGE	V <sub>dd</sub>	—	—	5.0	—	V
	SUPPLY CURRENT	I <sub>dd</sub>	V <sub>dd</sub> =5V	—	1.5	—	mA
	DRIVING VOLTAGE FOR LCD PANEL	V <sub>lcd</sub> = (V <sub>dd</sub> - V <sub>0</sub> )	-20°C	4.35	—	4.80	V
			0°C	4.30	—	4.75	
			25°C	4.25	4.50	4.75	
			50°C	4.10	—	4.65	
			70°C	4.00	—	4.55	

## LCD CHARACTERISTICS

**FOR STN/FSTN TYPE LCD Panel (TA=25 °C, Vlcd=5.0V ± 0.5V)**

	ITEM	SYMBOL	CONDITION	MIN	TYP	MAX	UNIT
	VIEWING ANGLE	$\Phi 2 - \Phi 1$	K=4	40	—	—	deg
		$\theta$		60			
	CONTRAST RATIO	K	—	6	—	—	—
	RESPONSE TIME(RISE)	TR	—	—	150	250	ms
	RESPONSE TIME(FALL)	TF	—	—	150	250	ms

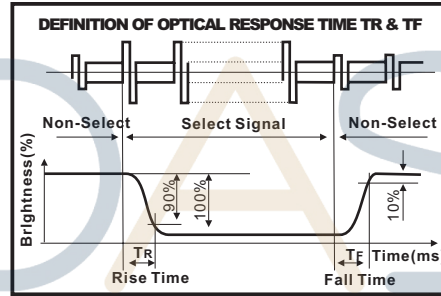
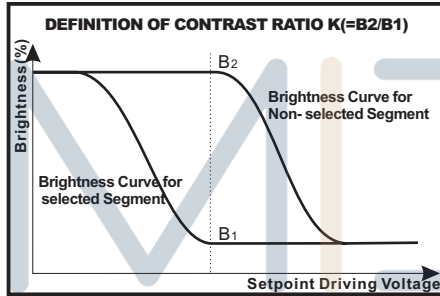
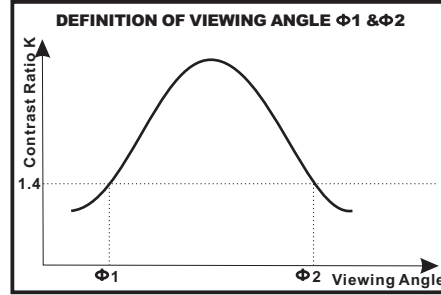
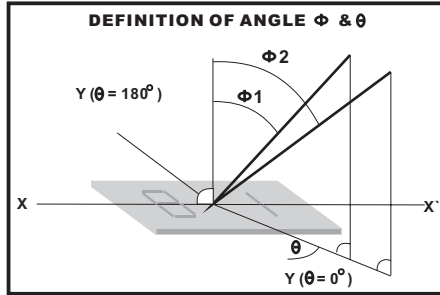

## LED CHARACTERISTICS

	ITEM	SYMBOL	CONDITION	MIN	TYP	MAX	UNIT
	LED FORWARD VOLTAGE	Vf	25 °C If = 2*5mA	—	3.0	—	V
	LED FORWARD CURRENT	If	25 °C	—	5	—	mA
	LED REVERSE CURRENT	Ir	25 °C Vr=5.0V	—	—	10	μA
	LED PEAK WAVE LENGTH	λp	25 °C If = 2*5mA	569	—	575	nm
	LED BRIGHTNESS (WITHOUT LCD)	Lv	25 °C If = 2*5mA	—	200	—	cd/m <sup>2</sup>
	LED BRIGHTNESS UNIFORMITY	Lvmin/Lvmax	25 °C If = 2*5mA	70	—	—	Ratio
	LED LIFE TIME	—	25 °C If = 2*5mA	20K	—	—	Hours



## PIN ASSIGNMENT

PIN	SYMBOL	DESCRIPTION	REMARKS
1	Vss	GND	
2	Vdd	Power supply for LCM	5.0V
3	V0	Contrast Adjust	
4	RS	Register Select Signal	
5	R/W	Data Read / Write	
6	E	Enable Signal	
7	DB0	Data bus line	
8	DB1	Data bus line	
9	DB2	Data bus line	
10	DB3	Data bus line	
11	DB4	Data bus line	
12	DB5	Data bus line	
13	DB6	Data bus line	
14	DB7	Data bus line	
15	LED+	Power supply for BKL	5.0V
16	LED-	Power supply for BKL	

## BLOCK DIAGRAM

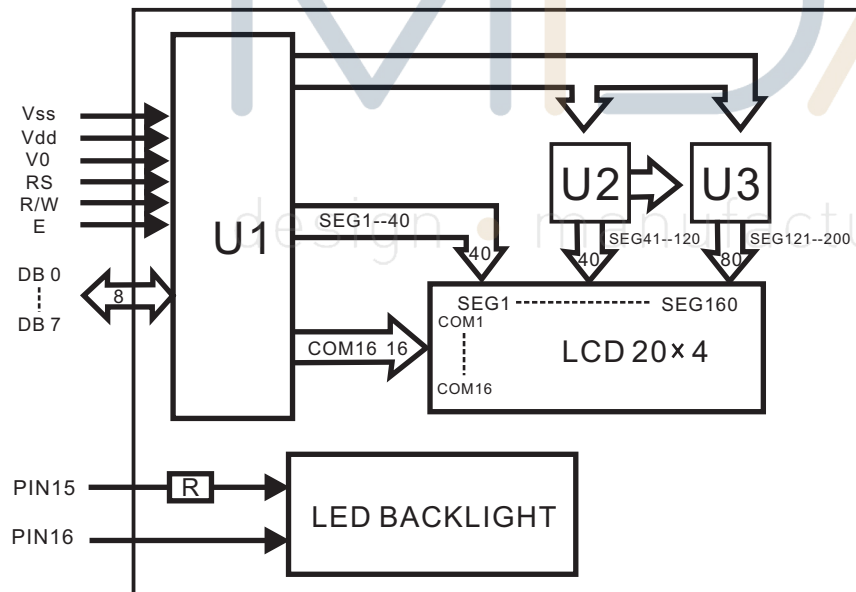

## POWER SUPPLY DIAGRAM

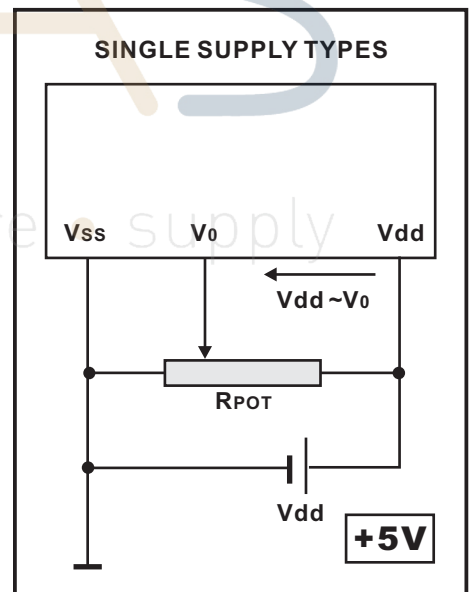

Upper 4bit Lower 4bit	LLLL	LLLH	LLHL	LLHH	LHLL	LHLH	LHHL	LHHH	HLLL	HLLH	HLHL	HLHH	HHLL	HHLH	HHHL	HHHH
LLLL	CG RAM (1)															
LLLH	(2)															
LLHL	(3)															
LLHH	(4)															
LHLL	(5)															
LHLH	(6)															
LHHL	(7)															
LHHH	(8)															
HLLL	(1)															
HLLH	(2)															
HLHL	(3)															
HLHH	(4)															
HHLL	(5)															
HHLH	(6)															
HHHL	(7)															
HHHH	(8)															



