



**PARA LIGHT ELECTRONICS CO., LTD.**  
11F, No.8, Jiankang Rd,Zhonghe Dist,New Taipei City 253, Taiwan  
Tel: 886-2-2225-3733 Fax: 886-2-2225-4800  
E-mail: [para@para.com.tw](mailto:para@para.com.tw) http:// [www.paralighttaiwan.com](http://www.paralighttaiwan.com)

# DATA SHEET

PART NO.: L-C195JRLGCT-5A

REV: A / 0

CUSTOMER'S APPROVAL: \_\_\_\_\_

DCC: \_\_\_\_\_

DRAWING NO.: DS-79-18-001

DATE: 2018-1-11

PAGE 1 of 14



# SURFACE MOUNT DEVICE LED

Part No.: L-C195JRLGCT-5A

REV:A / 0

## ● PACKAGE OUTLINE DIMENSIONS

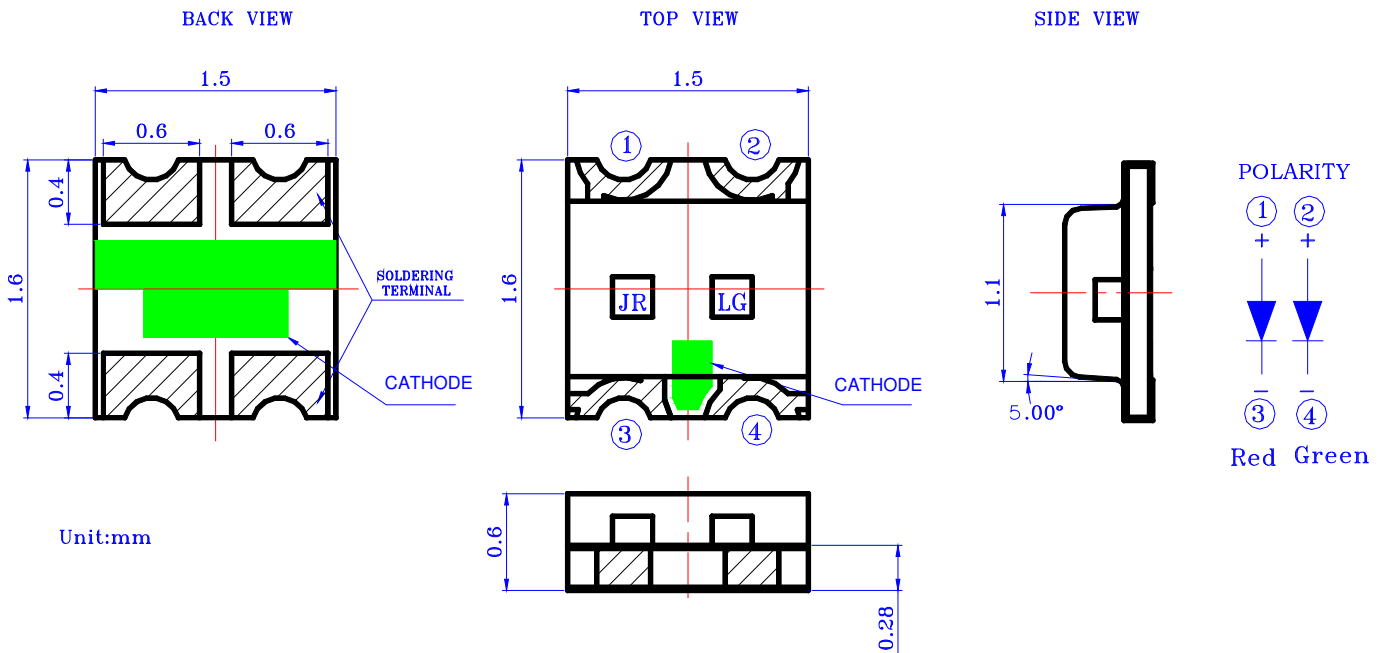

### Notes:

1. All dimensions are in millimeters.
2. Tolerance is  $\pm 0.1\text{mm}$  (.004") unless otherwise noted.

## ● Features

- \* Dual color, top view, wide view angle Chip LED.
- \* Package in 8mm tape on 7" diameter reels.
- \* Compatible with automatic Pick & Place equipment.
- \* Compatible with Reflow soldering and Wave soldering processes.
- \* EIA STD package.
- \* I.C. compatible.
- \* Pb free product.



## SURFACE MOUNT DEVICE LED

Part No.: L-C195JRLGCT-5A

REV:A / 0

### ● Chip Materials

Chip	Light Color	Dice Material	Lens Color
JR	Red	AlInGap	Water Clear
LG	Super Green	InGaN	

### ● Absolute Maximum Ratings (Ta=25°C)

Symbol	Parameter	Rating		Unit
		Red	Super Green	
P <sub>D</sub>	Power Dissipation	75	100	mW
I <sub>PF</sub>	Peak Forward Current (1/10 Duty Cycle, 0.1ms Pulse Width)	80	100	mA
I <sub>F</sub>	Continuous Forward Current	30	25	mA
-	De-rating Linear From 25°C	0.25	0.25	mA/°C
V <sub>R</sub>	Reverse Voltage	5	5	V
ESD	Electrostatic Discharge Threshold (HBM) <sup>Note A</sup>	2000	1000	V
Topr	Operating Temperature Range	-40 ~ +85		°C
Tstg	Storage Temperature Range	-40 ~ +85		°C

Note A:

HBM: Human Body Model. Seller gives no other assurances regarding the ability of to withstand ESD.

### ● Electro-Optical Characteristics (Ta=25°C)

Parameter	Symbol	Red	Super Green	Unit	Test Condition	
Luminous Intensity	Min.	11.2	71	mcd	IF=5mA	
	Typ.	15	110			
	Max.	28	180			
Viewing Angle	Typ.	2 θ 1/2		deg	Note 2	
Peak Wavelength	Typ.	λ <sub>p</sub>	646	521	nm	Measurement @Peak
Dominant Wavelength	Min.	λ <sub>d</sub>	626	520	nm	IF=5mA
	Typ.		631	525		
	Max.		636	535		
Spectral Line Half-Width	Typ.	Δ λ	17	15	nm	
Forward Voltage	Typ.	VF	1.8	2.8	V	IF =5mA
	Max.		2.1	3.1		
Reverse Current	Max.	IR	10	50	μ A	VR = 5V



**SURFACE MOUNT DEVICE LED**

Part No.: L-C195JRLGCT-5A

REV:A / 0

● Bin Code List

Luminous Intensity (IV), Unit: mcd@5mA					
Red			Super Green		
Bin Code	Min	Max	Bin Code	Min	Max
L	11.2	18	Q	71	112
M	18	28	R	112	180

Tolerance of each bin are  $\pm 15\%$

Dominant Wavelength (Hue), Unit: nm@5mA					
Red			Super Green		
Bin Code	Min	Max	Bin Code	Min	Max
R1	626	631	AP	520	525
R2	631	636	AQ	525	530
			AR	530	535

Tolerance of each bin are  $\pm 1\text{nm}$

Notes:

1. Luminous intensity is measured with a light sensor and filter combination that proximities the CIE eye-response curve.
2.  $\theta 1/2$  is the off-axis angle at which the luminous intensity is half the axial luminous intensity.
3. The dominant wavelength  $\lambda d$  is derived from the CIE chromaticity diagram and represents the single wavelength which defines the color of the device.
4. Caution in ESD:  
Static Electricity and surge damages the LED. It is recommended use a wrist band or anti-electrostatic glove when handling the LED. All devices, equipment and machinery must be properly grounded.
5. Major standard testing equipment by “Instrument System” Model: CAS140B Compact Array Spectrometer and “KEITHLEY” Source Meter Model: 2400.



# SURFACE MOUNT DEVICE LED

Part No.: L-C195JRLGCT-5A

REV:A / 0

## ● Red Typical Electro-Optical Characteristics Curves

(25°C Ambient Temperature Unless Otherwise Noted)

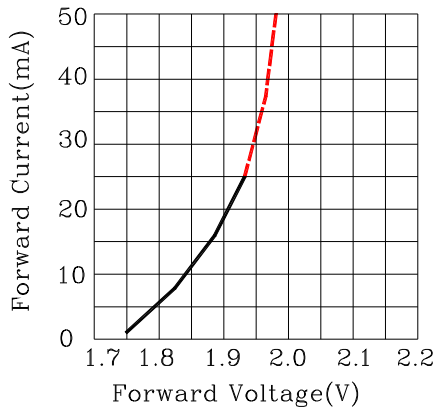

Fig.2 Forward Current vs. Forward Voltage

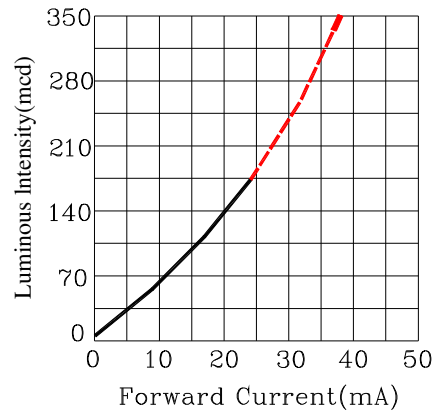

Fig.3 Luminous Intensity vs. Forward Current

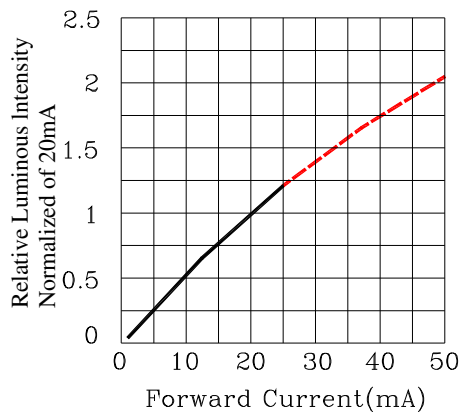

Fig.4 Relative Luminous Intensity vs. Forward Current

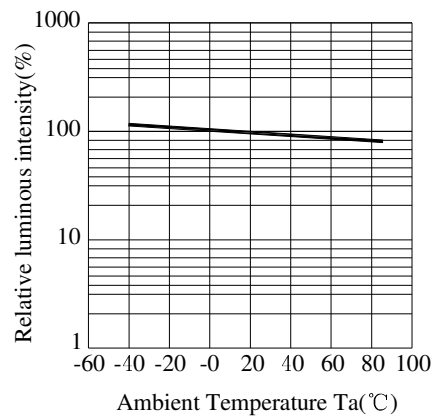

Fig.5 Luminous Intensity vs. Ambient Temperature

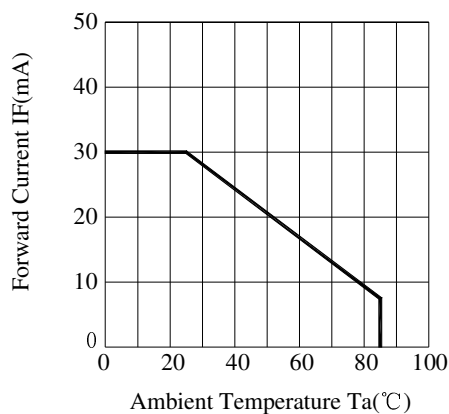

Fig.6 Forward Current Derating Curve

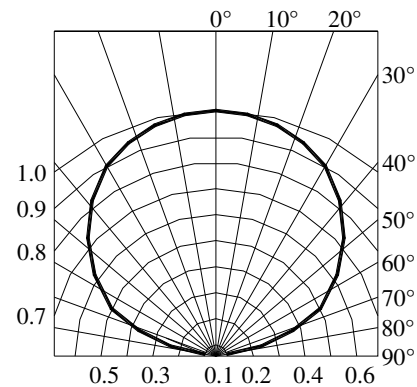

Fig.7 Relative Intensity vs. Angle



# SURFACE MOUNT DEVICE LED

Part No.: L-C195JRLGCT-5A

REV:A / 0

## ● Super Green Typical Electro-Optical Characteristics Curves

(25°C Ambient Temperature Unless Otherwise Noted)

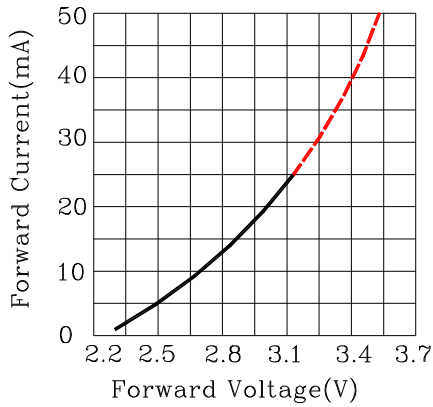

Fig.2 Forward Current vs. Forward Voltage

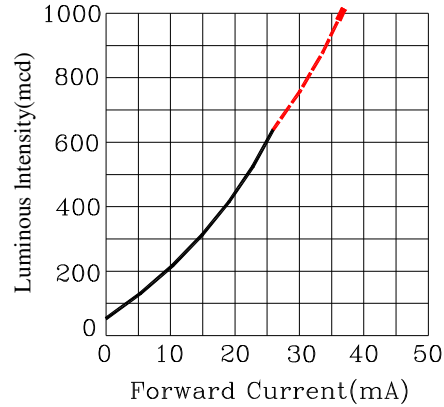

Fig.3 Luminous Intensity vs. Forward Current

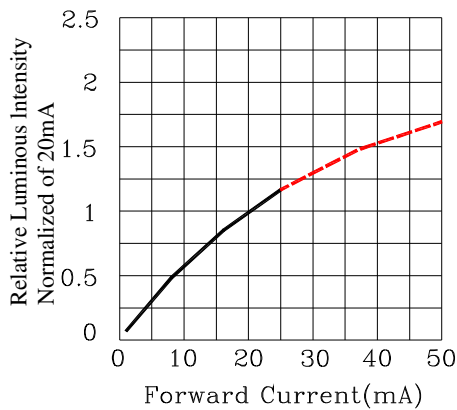

Fig.4 Relative Luminous Intensity vs. Forward Current

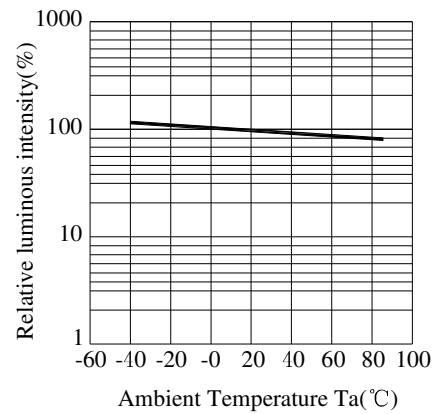

Fig.5 Luminous Intensity vs. Ambient Temperature

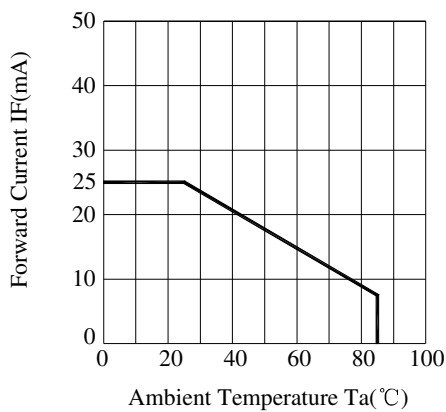

Fig.6 Forward Current Derating Curve

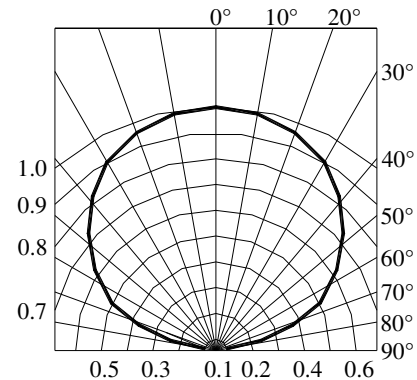

Fig.7 Relative Intensity vs. Angle



# SURFACE MOUNT DEVICE LED

Part No.: L-C195JRLGCT-5A

REV:A / 0

## ● Label Explanation



ITEM CODE:PARA LIGHT

PART NO: L-C195JRLGCT-5A

IV --- Luminous Intensity Code

LOT NO: EM S L 12 09 0110  
          A    B    C    D    E    F

A---EM: Emos Code

B---S:SMD

C---Local

D---Year

E---Month

F---SPEC.

PACKING QUANTITY OF BAG :

3000pcs for 150、170、110、155、115、195 series

4000pcs for 191 series

5000pcs for 192 series

DATE CODE: 2012 09 10  
                  G    H    I

G--- Year

H--- Month

I--- Day



# SURFACE MOUNT DEVICE LED

Part No.: L-C195JRLGCT-5A

REV:A / 0

## ● Typical Electro-Optical Characteristics Curves

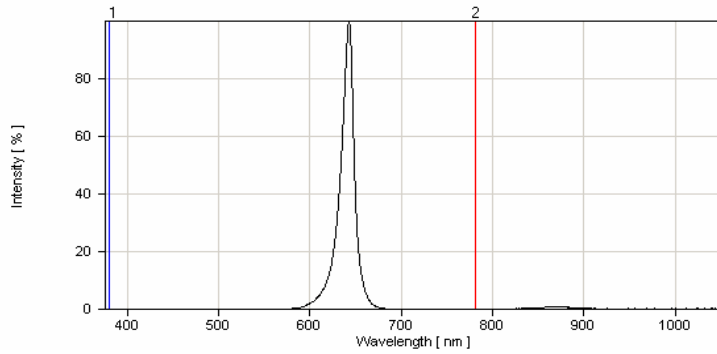

Fig.1 Red Relative Intensity vs. Wavelength

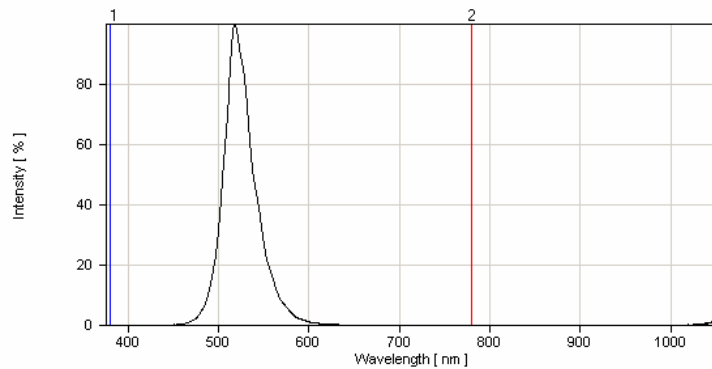
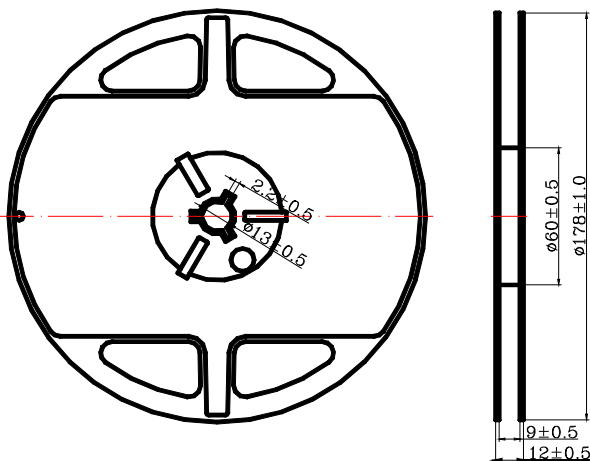

Fig.1 Green Relative Intensity vs. Wavelength

## ● Reel Dimensions



### Notes:

1. Taping Quantity: 3000pcs
2. The tolerances unless mentioned is  $\pm 0.1\text{mm}$ , Angle  $\pm 0.5^\circ$ , Unit: mm.





# SURFACE MOUNT DEVICE LED

Part No.: L-C195JRLGCT-5A

REV:A / 0

## ● Package Dimensions Of Tape And Reel

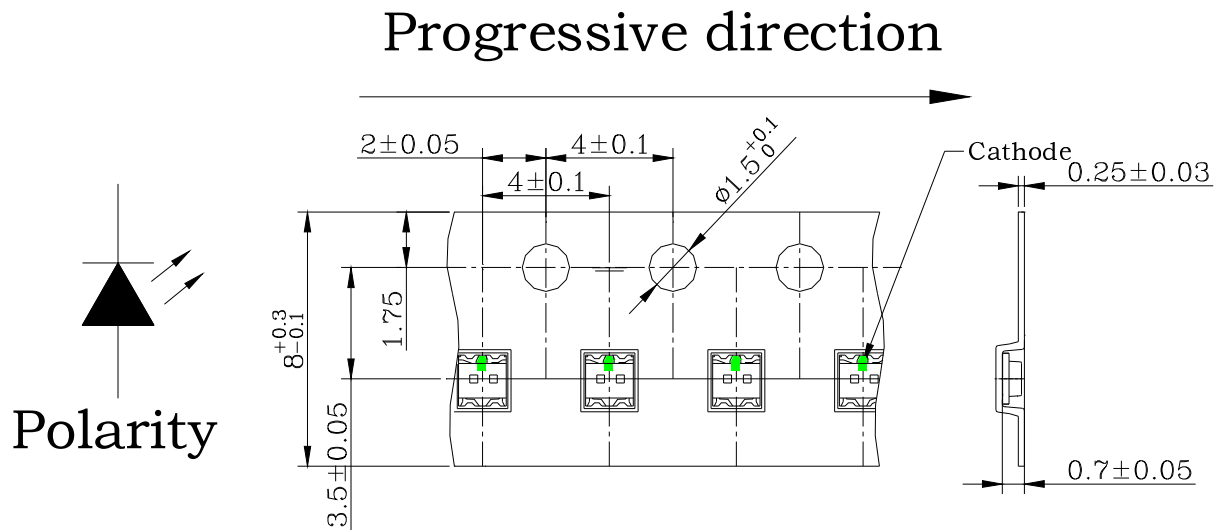

Notes: All dimensions are in millimeters.

## Moisture Resistant Packaging

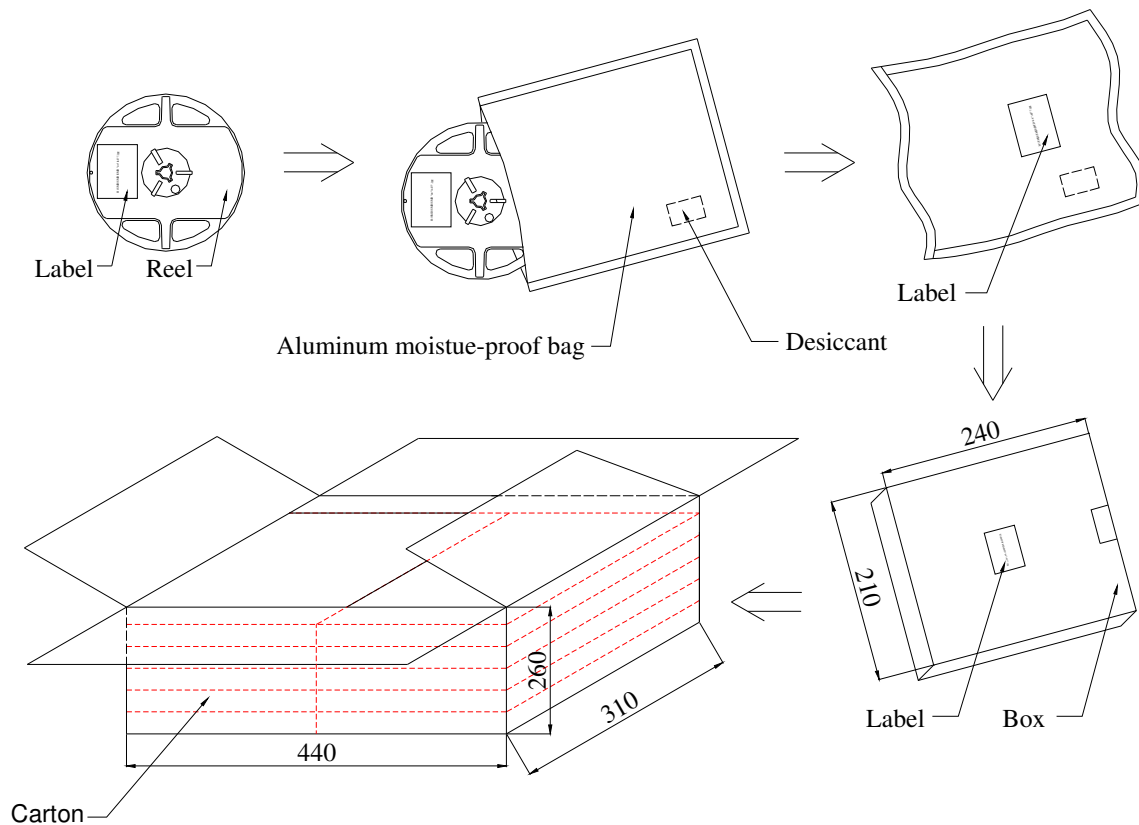

Notes : One reel in a bag, six bag in a inner box, six inner boxes in a carton. Unit : mm



## SURFACE MOUNT DEVICE LED

Part No.: L-C195JRLGCT-5A

REV:A / 0

### ● Cleaning

- \* If cleaning is required , use the following solutions for less than 1 minute and less than 40°C .
- \* Appropriate chemicals: Ethyl alcohol and isopropyl alcohol.
- \* Effect of ultrasonic cleaning on the LED resin body differs depending on such factors as the oscillator output, size of PCB and LED mounting method. The use of ultrasonic cleaning should be enforced at proper output after confirming there is no problem.

### ● Suggest Soldering Pad Dimensions

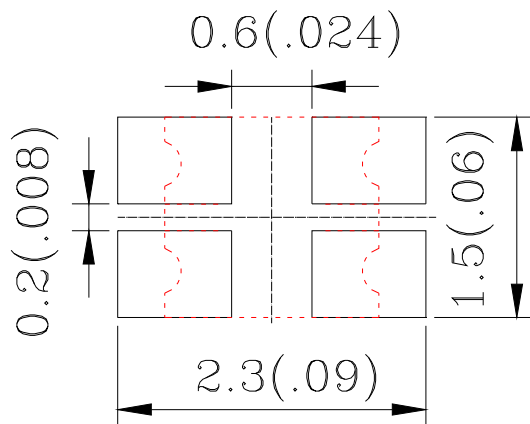

Direction of PWB camber  
and go to reflow furnace



# SURFACE MOUNT DEVICE LED

Part No.: L-C195JRLGCT-5A

REV:A / 0

● Suggest Sn/Pb IR Reflow Soldering Profile Condition:

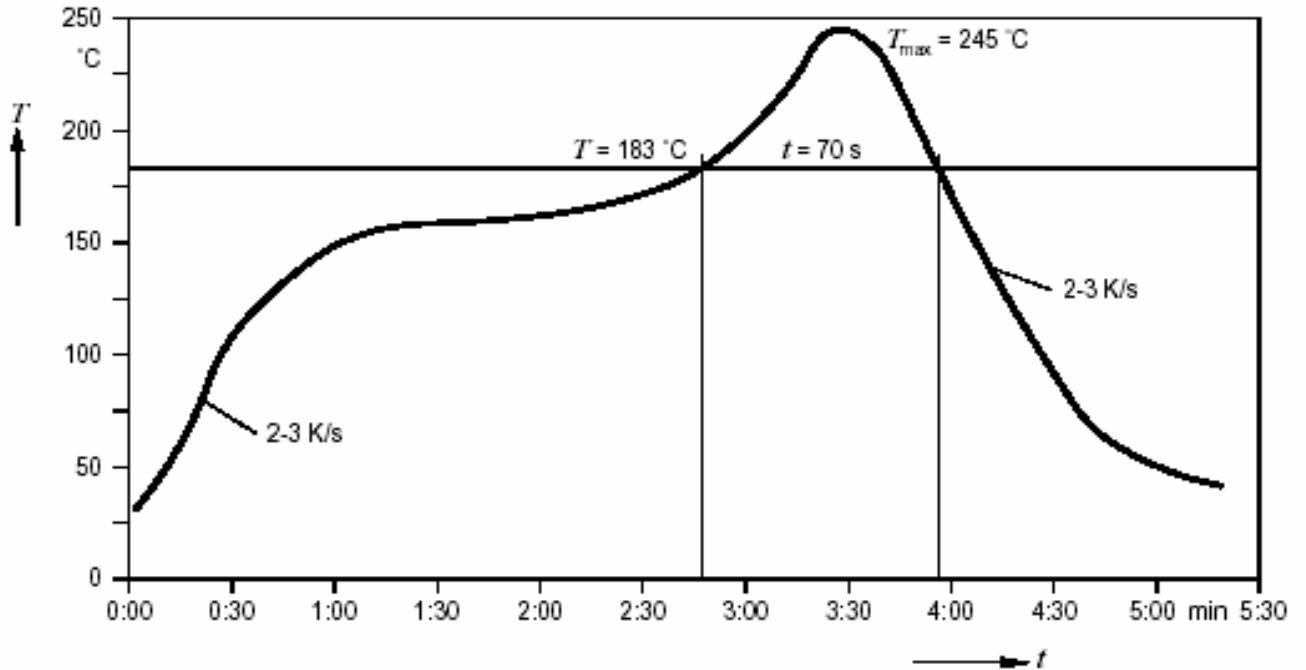

● Suggest Pb-Free IR Reflow Soldering Profile Condition:

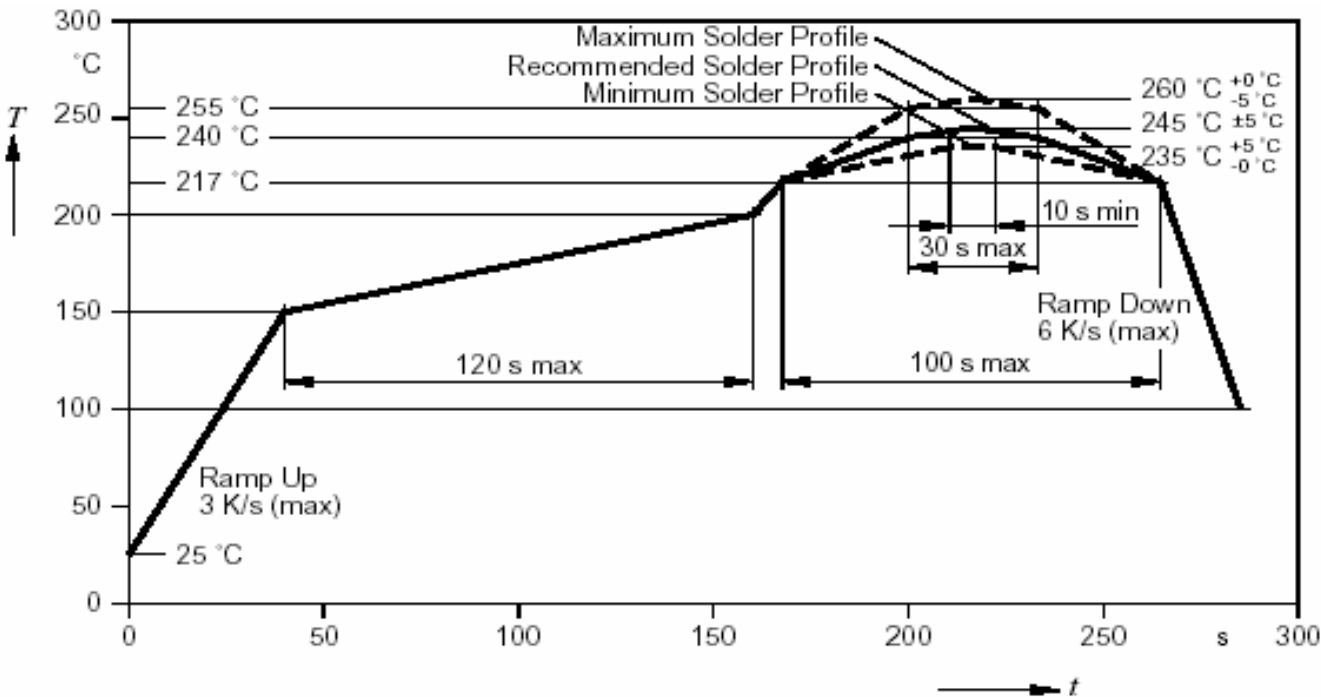



## SURFACE MOUNT DEVICE LED

Part No.: L-C195JRLGCT-5A

REV:A / 0

## CAUTIONS

## 1.Application Limitation:

The LED's described here are intended to be used for ordinary electronic equipment (such as office equipment, communication equipment and household application). Consult PARA's sales in advance for information on application in which exceptional quality and reliability are required, particularly when the failure or malfunction of the LED's may directly jeopardize life or health (such as airplanes, automobiles, traffic control equipment, life support system and safety devices).

## 2.Storage:

Do not open moisture proof bag before the products are ready to use.

Before opening the package: The LEDs should be kept at 30°C or less and 90%RH or less.

After opening the package: The LED's floor life is 1 year under 30°C or less and 60% RH or less. If unused LEDs remain, it should be stored in moisture proof packages.

If the moisture absorbent material (silica gel) has faded away or the LEDs have exceeded the storage time, baking treatment should be performed using the following conditions.

Baking treatment: 60±5°C for 24 hours

## 3.Soldering

Do not apply any stress to the lead frame during soldering while the LED is at high temperature.

Recommended soldering condition.

Reflow Soldering:

Pre-heat 120~150°C, 120sec. MAX., Peak temperature : 240°C Max. Soldering time: 10 sec Max.

Soldering Iron: (Not recommended)

Temperature 300°C Max., Soldering time : 3 sec. Max.(one time only), power dissipation of iron : 20W Max. use SN60 solder of solder with silver content and don't to touch LED lens when soldering.

Wave soldering:

Pre-heat 100°C Max, Pre-heat time 60 sec. Max, Solder wave 260°C Max, Soldering time 5 sec. Max. performed consecutively cooling process is required between 1<sup>st</sup> and 2<sup>nd</sup> soldering processes.



## SURFACE MOUNT DEVICE LED

Part No.: L-C195JRLGCT-5A

REV:A / 0

### 4. Lead-Free Soldering

For Reflow Soldering:

- 1、Pre-Heat Temp:150-180°C,120sec.Max.
- 2、Soldering Temp: Temperature Of Soldering Pot Over 230°C,40sec.Max.
- 3、Peak Temperature:260°C , 5sec.
- 4、Reflow Repetition:2 Times Max.
- 5、Suggest Solder Paste Formula 93.3 Sn/3.1 Ag/3.1 Bi /0.5 Cu

For Soldering Iron (Not Recommended):

- 1、Iron Tip Temp:350°C Max.
- 2、Soldering Iron:30w Max.
- 3、Soldering Time:3 Sec. Max. One Time.

For Dip Soldering:

- 1、Pre-Heat Temp:150°C Max. 120 Sec. Max.
- 2、Bath Temp:265°C Max.
- 3、Dip Time:5 Sec. Max.

### 5. Drive Method

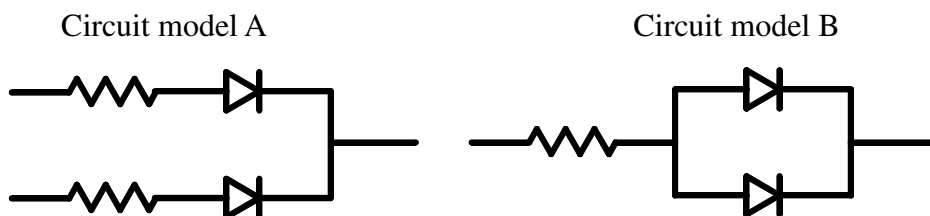

(A)Recommended circuit.

(B)The difference of brightness between LED`s could be found due to the Vf-If characteristics of LED.



# SURFACE MOUNT DEVICE LED

Part No.: L-C195JRLGCT-5A

REV:A / 0

## 6. Reliability Test

Classification	Test Item	Test Condition	Reference Standard
Endurance Test	Operation Life	Ta= Under Room Temperature As Per Data Sheet Maximum Rating *Test Time= 1000HRS (-24HRS,+72HRS)*@20mA.	MIL-STD-750D: 1026 (1995) MIL-STD-883D: 1005 (1991) JIS C 7021:B-1 (1982)
	High Temperature High Humidity Storage	IR-Reflow In-Board, 2 Times Ta= 65±5°C, RH= 90~95% *Test Time= 1000HRS±2HRS	MIL-STD-202F: 103B(1980) JIS C 7021: B-11 (1982)
	High Temperature Storage	Ta= 105±5°C Test Time= 1000HRS (-24HRS, 72HRS)	MIL-STD-883D: 1008 (1991) JIS C 7021:B-10 (1982)
	Low Temperature Storage	Ta= -55±5°C *Test Time=1000HRS (-24HRS, 72H RS)	JIS C 7021:B-12 (1982)
Environmental Test	Temperature Cycling	105±5°C      -55±5°C 10mins      10mins      100 Cycles	MIL-STD-202F: 107D (1980) MIL-STD-750D: 1051(1995) MIL-STD-883D: 1010 (1991) JIS C 7021: A-4 (1982)
	Thermal Shock	IR-Reflow In-Board, 2 Times 105±5°C      -55°C±5°C 10mins      10mins      100 Cycles	MIL-STD-202F: 107D(1980) MIL-STD-750D: 1051(1995) MIL-STD-883D: 1011(1991)
	Solder Resistance	Tsol= 260 ± 5°C Dwell Time= 10 ± 1sec	MIL-STD-202F: 210A(1980) MIL-STD-750D: 2031(1995) JIS C 7021: A-1 (1982)
	Solder ability	Tsol= 235 ± 5°C Immersion time 2±0.5 sec Immersion rate 25±2.5 mm/sec Coverage ≥95% of the dipped surface	MIL-STD-202F: 208D(1980) MIL-STD-750D: 2026(1995) MIL-STD-883D: 2003(1991) IEC 68 Part 2-20 JIS C 7021: A-2 (1982)

## 7. Others:

The appearance and specifications of the product may be modified for improvement without notice.