

## 150 mA Low-Dropout Regulator

### Features

- AEC-Q100 for Fixed Option
- High Output Voltage Accuracy
- Variety of Output Voltages
- Ensured 150 mA Output
- Low Quiescent Current
- Low-Dropout Voltage
- Extremely Tight Load and Line Regulation
- Very Low-Temperature Coefficient
- Current and Thermal Limiting
- Reverse-Battery Protection
- Load-Dump Protection (Fixed Voltage Versions)
- Zero Off Mode Current
- Logic-Controlled Electronic Enable
- Available in 8-Lead SOIC and SOT-223 Packages

### Applications

- Cellular Telephones
- Laptop, Notebook and Palmtop Computers
- Battery-Powered Equipment
- PCMCIA  $V_{CC}$  and  $V_{PP}$  Regulation/Switching
- Barcode Scanners
- SMPS Post-Regulator and DC/DC Modules
- High-Efficiency Linear Power Supplies

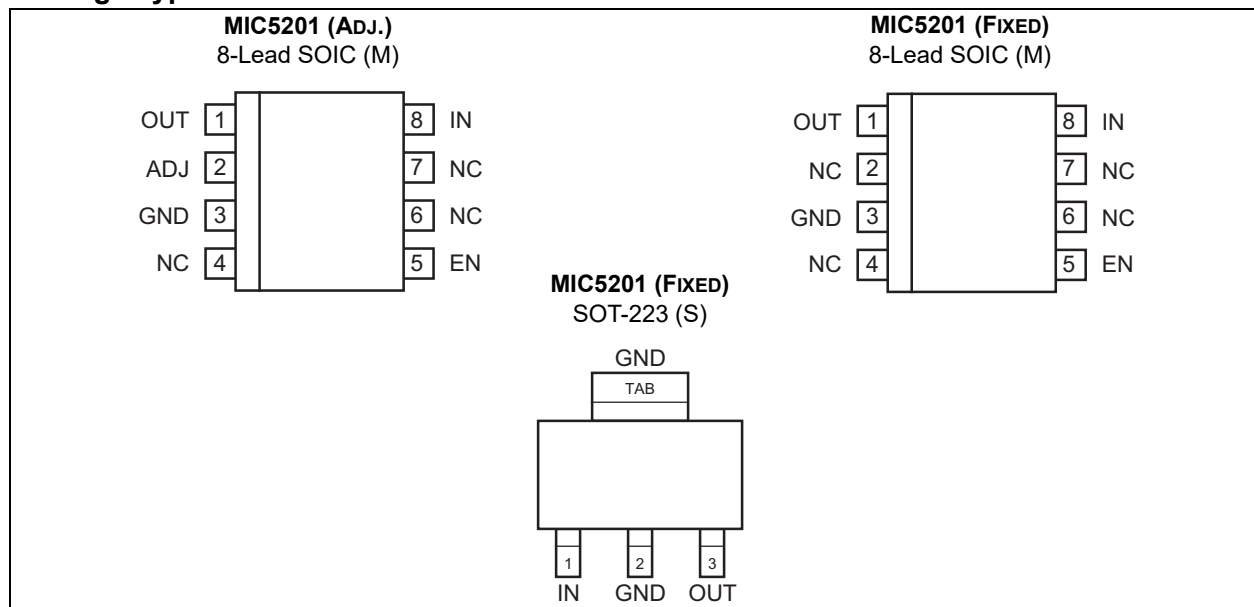
### General Description

The MIC5201 is an efficient linear voltage regulator with very Low-Dropout voltage (typically 17 mV at light loads and 200 mV at 100 mA), and very low ground current (1 mA at 100 mA output), offering better than 1% initial accuracy with a logic compatible on-off switching input.

Designed especially for handheld battery-powered devices, the MIC5201 can be switched by a CMOS compatible enable signal. This enable control may be connected directly to  $V_{IN}$  if unneeded. When disabled, power consumption drops nearly to zero. The ground current of the MIC5201 increases only slightly in dropout, further prolonging battery life. Key MIC5201 features include current limiting, overtemperature shutdown and protection against reversed battery.

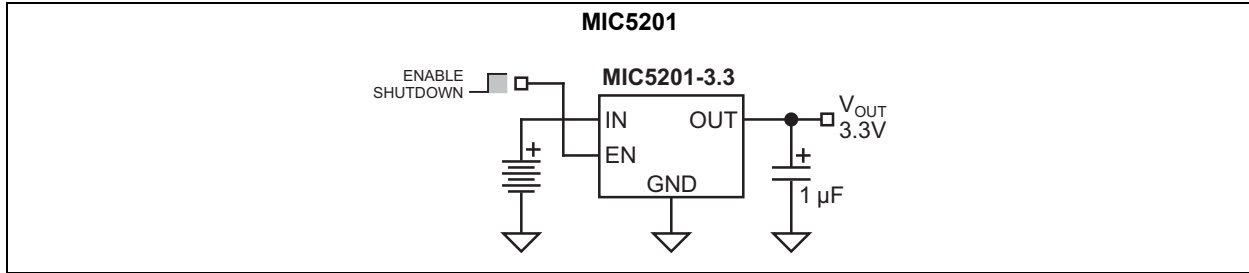
The MIC5201 is available in several fixed voltages and accuracy configurations. It features the same pinout as the LT1121 with better performance. Other options are available; contact Microchip for details.

### Package Types

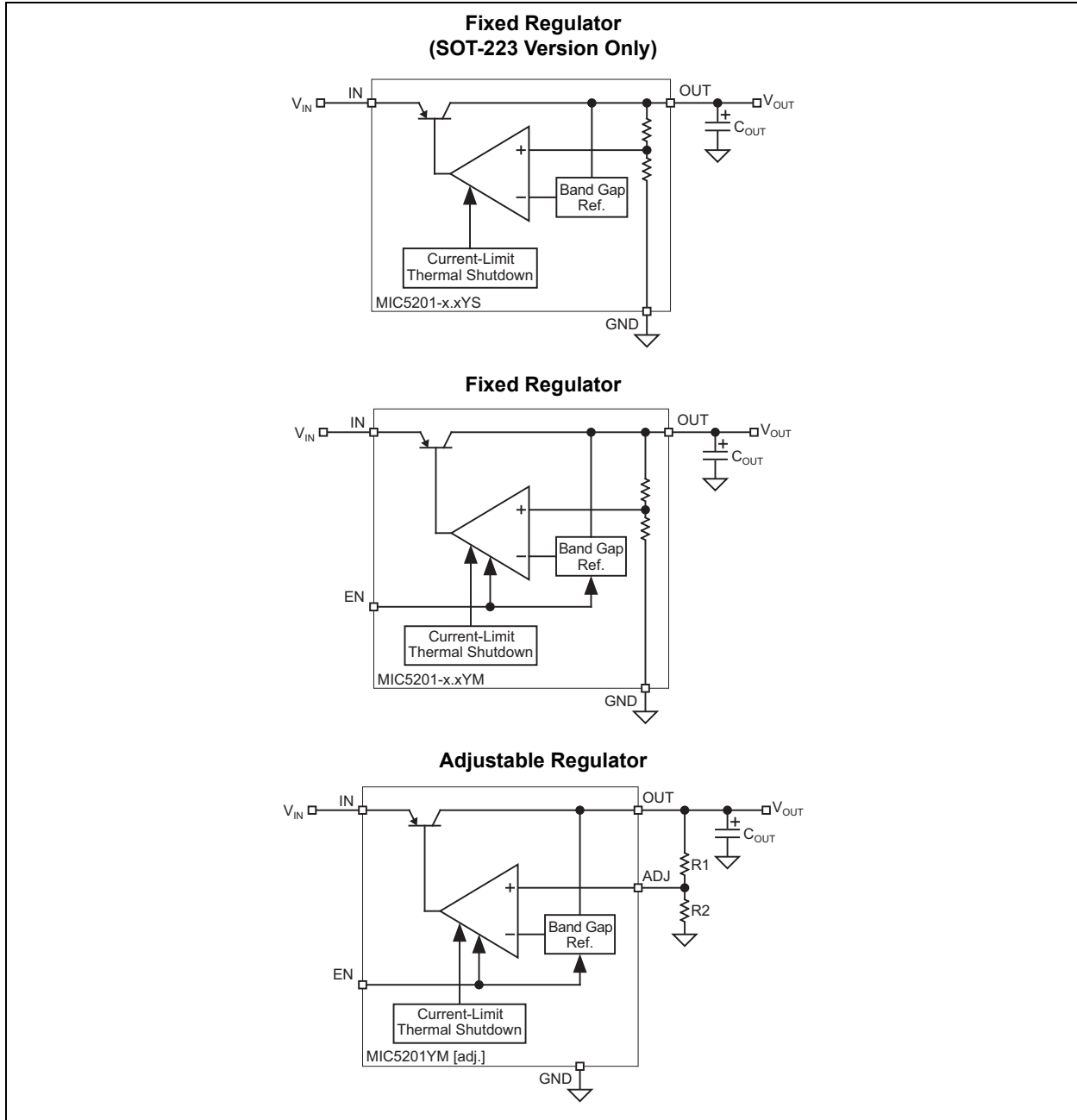


# MIC5201

## Typical Application Circuit



## Functional Diagrams



## 1.0 ELECTRICAL CHARACTERISTICS

### Absolute Maximum Ratings†

Supply Input Voltage ( $V_{IN}$ ) Fixed.....	-20V to +60V
Supply Input Voltage ( $V_{IN}$ ) Adjustable.....	-20V to +20V
Enable Input Voltage ( $V_{EN}$ ) Fixed.....	-20V to +60V
Enable Input Voltage ( $V_{EN}$ ) Adjustable.....	-20V to +20V
Power Dissipation ( <b>Note 1</b> ).....	Internally Limited

### Operating Ratings‡

Supply Input Voltage ( $V_{IN}$ ) Fixed.....	+2.5V to +26V
Supply Input Voltage ( $V_{IN}$ ) Adjustable.....	+2.5V to +16V
Enable Input Voltage ( $V_{EN}$ ).....	0V to $V_{IN}$

† **Notice:** Stresses above those listed under “Absolute Maximum Ratings” may cause permanent damage to the device. This is a stress rating only and functional operation of the device at those or any other conditions above those indicated in the operational sections of this specification is not intended. Exposure to maximum rating conditions for extended periods may affect device reliability.

‡ **Notice:** The device is not ensured to function outside its operating ratings.

**Note 1:** The maximum allowable power dissipation is a function of the maximum junction temperature,  $T_{J(max)}$ , the junction-to-ambient thermal resistance,  $\theta_{JA}$ , and the ambient temperature,  $T_A$ . The maximum allowable power dissipation at any ambient temperature is calculated using:  $P_{(max)} = (T_{J(max)} - T_A) \div \theta_{JA}$ . Exceeding the maximum allowable power dissipation will result in excessive die temperature, and the regulator will go into thermal shutdown.

# MIC5201

**TABLE 1-1: ELECTRICAL CHARACTERISTICS<sup>(1)</sup>**

**Electrical Characteristics:**  $V_{IN} = V_{OUT} + 1V$ ;  $I_L = 100 \mu A$ ;  $C_L = 3.3 \mu F$ ;  $V_{EN} \geq 2.0V$ ;  $T_J = +25^\circ C$ , **bold** values indicate  $-40^\circ C \leq T_J \leq +85^\circ C$  unless noted.

Parameter	Symbol	Min.	Typ.	Max.	Units	Conditions
Output Voltage Accuracy	$V_O$	<b>-2</b>	1	<b>2</b>	%	Variation from specified $V_{OUT}$
Output Voltage Temperature Coefficient	$\Delta V_O / \Delta T$	—	40	<b>150</b>	ppm/ $^\circ C$	<b>Note 2</b>
Line Regulation, Fixed	$\Delta V_O / \Delta V_{IN}$	—	0.004	0.20	%	$V_{IN} = V_{OUT} + 1V$ to 26V
		—	—	<b>0.40</b>		
Line Regulation, Adjustable	$\Delta V_O / \Delta V_{IN}$	—	0.004	0.20	%	$V_{IN} = V_{OUT} + 1V$ to 16V
		—	—	<b>0.40</b>		
Load Regulation	$\Delta V_O / V_O$	—	0.04	0.30	%	$I_L = 0.1 mA$ to 150 mA ( <b>Note 3</b> )
		—	—	<b>0.40</b>		
Dropout Voltage ( <b>Note 4</b> )	$V_{IN} - V_O$	—	17	—	mV	$I_L = 100 \mu A$ ( <b>Note 7</b> )
		—	130	—		$I_L = 20 mA$ ( <b>Note 7</b> )
		—	180	—		$I_L = 50 mA$ ( <b>Note 7</b> )
		—	225	—		$I_L = 100 mA$ ( <b>Note 7</b> )
		—	270	<b>400</b>		$I_L = 150 mA$
Quiescent Current	$I_{GND}$	—	0.01	—	$\mu A$	$V_{ENABLE} \leq 0.5V$ (shutdown) ( <b>Note 7</b> )
Ground Pin Current	$I_{GND}$	—	130	—	$\mu A$	$I_L = 100 \mu A$ ( <b>Note 7</b> )
		—	270	400		$I_L = 20 mA$
		—	500	—		$I_L = 50 mA$ ( <b>Note 7</b> )
		—	1000	<b>2000</b>		$I_L = 100 mA$
		—	3000	—		$I_L = 150 mA$ ( <b>Note 7</b> )
Ripple Rejection	PSRR	—	75	—	dB	<b>Note 7</b>
Ground Pin Current at Dropout	$I_{GNDDO}$	—	270	<b>330</b>	$\mu A$	$V_{IN} = 0.5V$ less than specified $V_{OUT}$ , $I_L = 100 \mu A$ ( <b>Note 5</b> )
Current Limit	$I_{LIMIT}$	—	280	500	mA	$V_{OUT} = 0V$
Thermal Regulation	$\Delta V_O / \Delta P_D$	—	0.05	—	%/W	<b>Note 6</b>
Output Noise	$e_n$	—	100	—	$\mu V$	<b>Note 7</b>
<b>Enable Input</b>						
Input Voltage Level	$V_{IL}$	—	—	<b>0.5</b>	V	Logic low (off)
Input Voltage Level	$V_{IH}$	<b>2.0</b>	—	—	V	Logic high (on)
Enable Input Current	$I_{IL}$	—	0.01	<b>1</b>	$\mu A$	$V_{IL} \leq 0.5V$
Enable Input Current	$I_{IH}$	—	15	<b>70</b>	$\mu A$	$V_{IH} \geq 2.0V$

**Note 1:** Specification for packaged product only. Devices are ESD-sensitive. Handling precautions recommended.

**2:** Output voltage temperature coefficient is defined as the worst-case voltage change divided by the total temperature range.

**3:** Regulation is measured at constant junction temperature using low duty cycle pulse testing. Parts are tested for load regulation in the load range from 0.1 mA to 150 mA. Changes in output voltage due to heating effects are covered by the thermal regulation specification.

**4:** Dropout voltage is defined as the input to output differential at which the output voltage drops 2% below its nominal value measured at 1V differential.

**5:** Ground pin current is the regulator quiescent current plus pass transistor base current. The total current drawn from the supply is the sum of the load current plus the ground pin current.

**6:** Thermal regulation is defined as the change in output voltage at a time "t" after a change in power dissipation is applied, excluding load or line regulation effects. Specifications are for a 150 mA load pulse at  $V_{IN} = 26V$  for fixed and  $V_{IN} = 16V$  for adjustable at  $t = 10 ms$ .

**7:** Design guidance only, not production tested.

**TABLE 1-1: ELECTRICAL CHARACTERISTICS<sup>(1)</sup> (CONTINUED)**

**Electrical Characteristics:**  $V_{IN} = V_{OUT} + 1V$ ;  $I_L = 100 \mu A$ ;  $C_L = 3.3 \mu F$ ;  $V_{EN} \geq 2.0V$ ;  $T_J = +25^\circ C$ , **bold** values indicate  $-40^\circ C \leq T_J \leq +85^\circ C$  unless noted.

Parameter	Symbol	Min.	Typ.	Max.	Units	Conditions
<b>Reference (MIC5201 Adjustable Version Only)</b>						
Reference Voltage	$V_{REF}$	1.223	1.242	1.255	V	
		<b>1.217</b>	—	<b>1.267</b>		
Reference Voltage Temperature Coefficient	$\Delta V_{REF}/\Delta T$	—	20	—	ppm/ $^\circ C$	<b>Note 7</b>

**Note 1:** Specification for packaged product only. Devices are ESD-sensitive. Handling precautions recommended.

- 2:** Output voltage temperature coefficient is defined as the worst-case voltage change divided by the total temperature range.
- 3:** Regulation is measured at constant junction temperature using low duty cycle pulse testing. Parts are tested for load regulation in the load range from 0.1 mA to 150 mA. Changes in output voltage due to heating effects are covered by the thermal regulation specification.
- 4:** Dropout voltage is defined as the input to output differential at which the output voltage drops 2% below its nominal value measured at 1V differential.
- 5:** Ground pin current is the regulator quiescent current plus pass transistor base current. The total current drawn from the supply is the sum of the load current plus the ground pin current.
- 6:** Thermal regulation is defined as the change in output voltage at a time “t” after a change in power dissipation is applied, excluding load or line regulation effects. Specifications are for a 150 mA load pulse at  $V_{IN} = 26V$  for fixed and  $V_{IN} = 16V$  for adjustable at  $t = 10 \text{ ms}$ .
- 7:** Design guidance only, not production tested.

# MIC5201

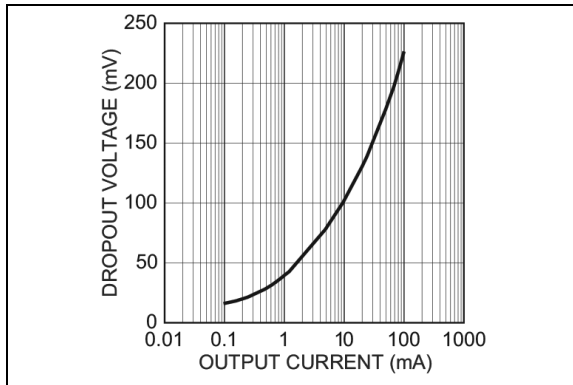
## TEMPERATURE SPECIFICATIONS<sup>(1)</sup>

Parameters	Sym.	Min.	Typ.	Max.	Units	Conditions
<b>Temperature Ranges</b>						
Storage Temperature Range	$T_J$	-40	—	+125	°C	—
Lead Temperature	—	—	—	+260	°C	Soldering, 5 sec.
<b>Package Thermal Resistance</b>						
Thermal Resistance SOT-223	$\theta_{JC}$	—	15	—	°C/W	See <a href="#">Section 4.6 “Thermal Considerations Layout”</a> for more information.
	$\theta_{JA}$	—	62	—		
Thermal Resistance 8-Lead SOIC	$\theta_{JA}$	—	160	—	°C/W	See <a href="#">Section 4.6 “Thermal Considerations Layout”</a> for more information.

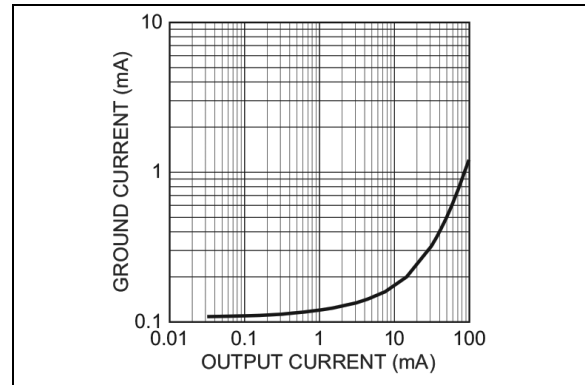
**Note 1:** The maximum allowable power dissipation is a function of ambient temperature, the maximum allowable junction temperature and the thermal resistance from junction to air (i.e.,  $T_A$ ,  $T_J$ ,  $\theta_{JA}$ ). Exceeding the maximum allowable power dissipation will cause the device operating junction temperature to exceed the maximum +125°C rating. Sustained junction temperatures above +125°C can impact the device reliability.

## 2.0 TYPICAL PERFORMANCE CURVES

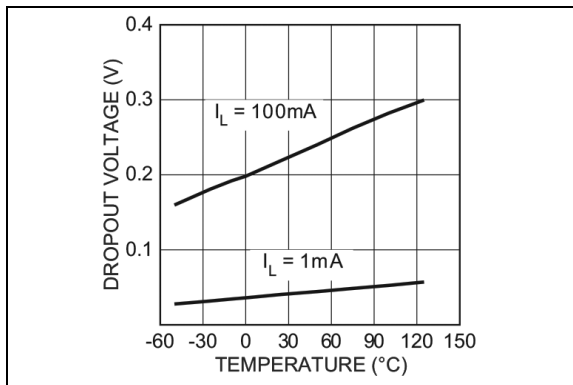
**Note:** The graphs and tables provided following this note are a statistical summary based on a limited number of samples and are provided for informational purposes only. The performance characteristics listed herein are not tested or guaranteed. In some graphs or tables, the data presented may be outside the specified operating range (e.g., outside specified power supply range) and therefore outside the warranted range.



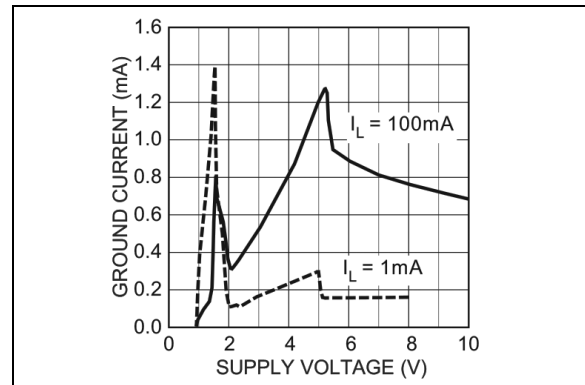
**FIGURE 2-1:** Dropout Voltage vs. Output Current.



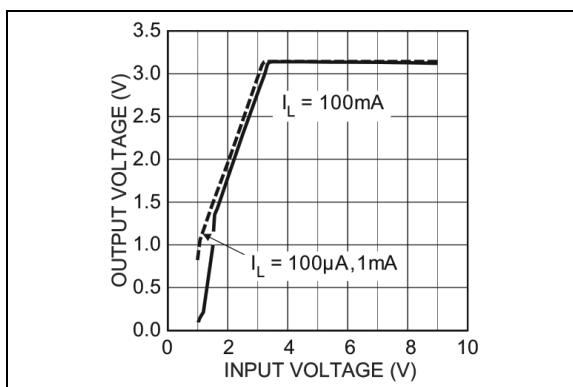
**FIGURE 2-4:** Ground Current vs. Output Current.



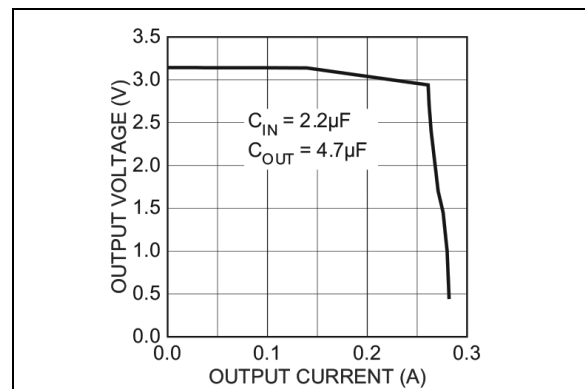
**FIGURE 2-2:** Dropout Voltage vs. Temperature.



**FIGURE 2-5:** Ground Current vs. Supply Voltage.

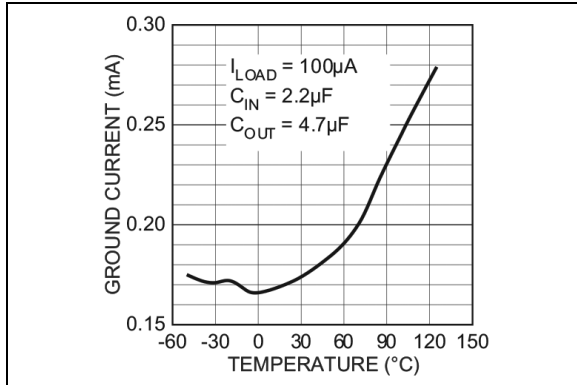


**FIGURE 2-3:** Dropout Characteristics.

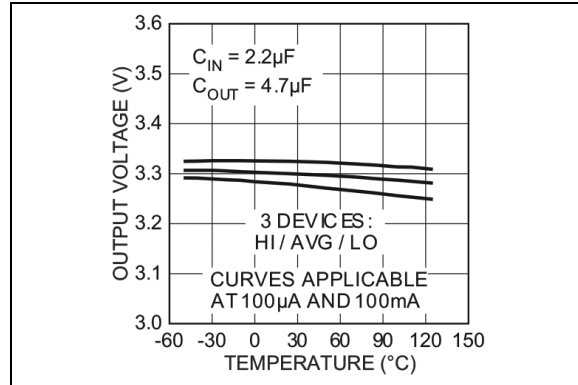


**FIGURE 2-6:** Output Voltage vs. Output Current.

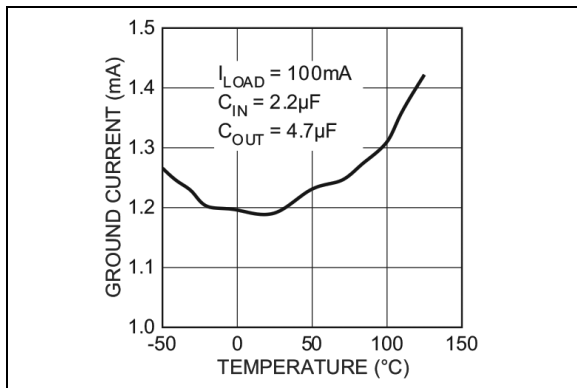
# MIC5201



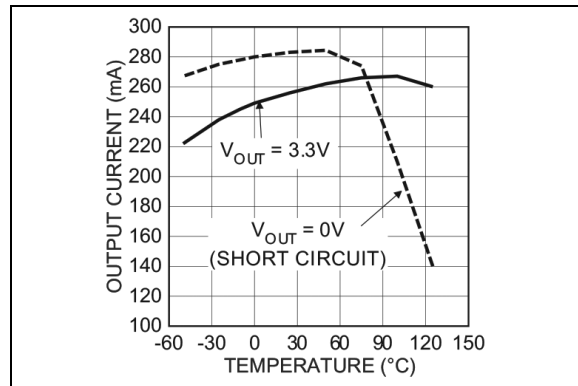
**FIGURE 2-7:** Ground Current vs. Temperature.



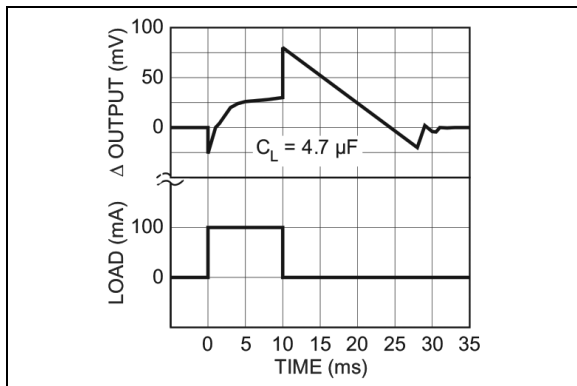
**FIGURE 2-10:** Output Voltage vs. Temperature (3.3V Version).



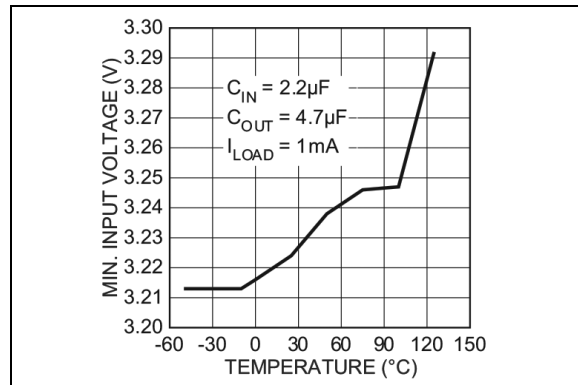
**FIGURE 2-8:** Ground Current vs. Temperature.



**FIGURE 2-11:** Output Current vs. Temperature.

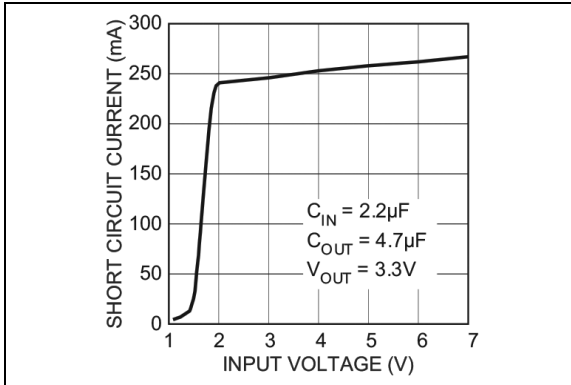


**FIGURE 2-9:** Thermal Regulation (3.3V Version).

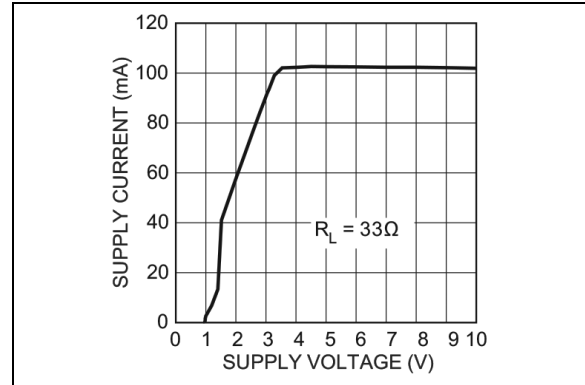


**FIGURE 2-12:** Minimum Input Voltage vs. Temperature.

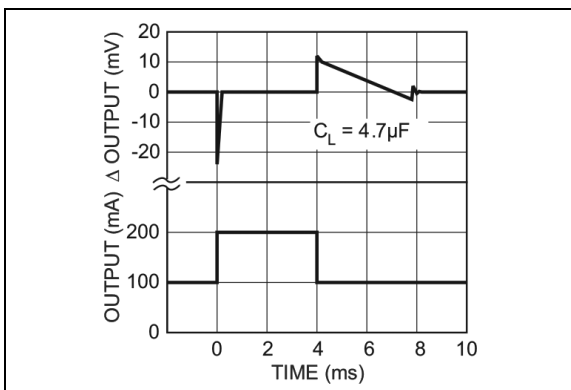




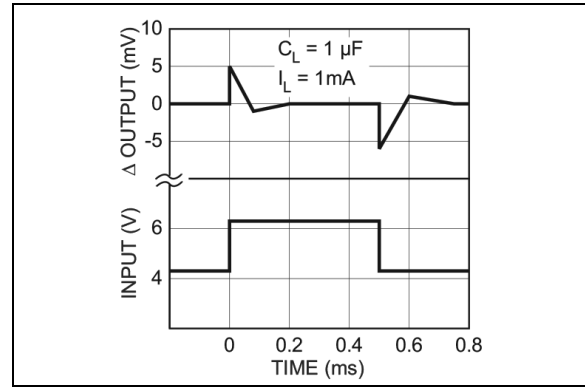
**FIGURE 2-13:** Short-Circuit Current vs. Input Voltage.



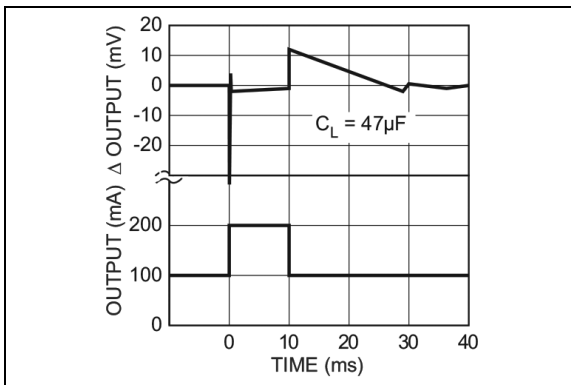
**FIGURE 2-16:** Supply Current vs. Supply Voltage (3.3V Version).



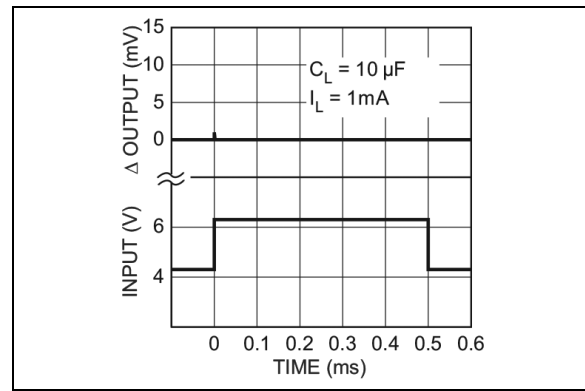
**FIGURE 2-14:** Load Transient.



**FIGURE 2-17:** Line Transient.

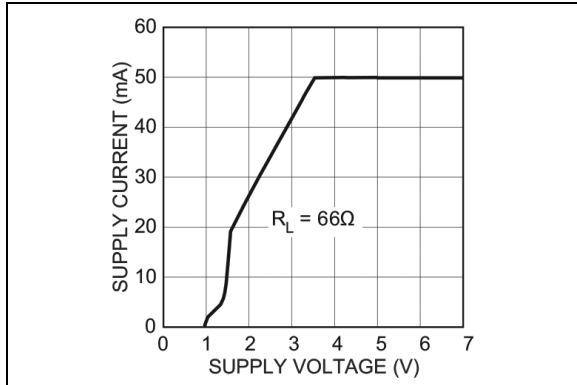


**FIGURE 2-15:** Load Transient.

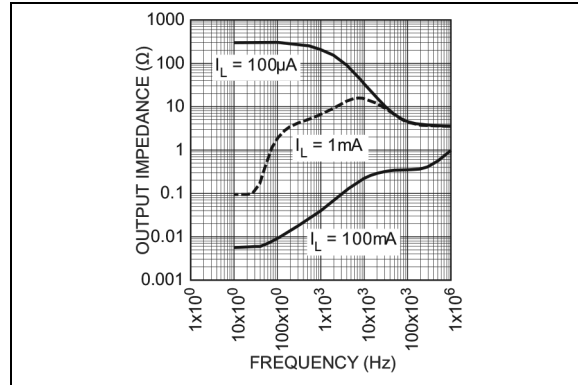


**FIGURE 2-18:** Line Transient.

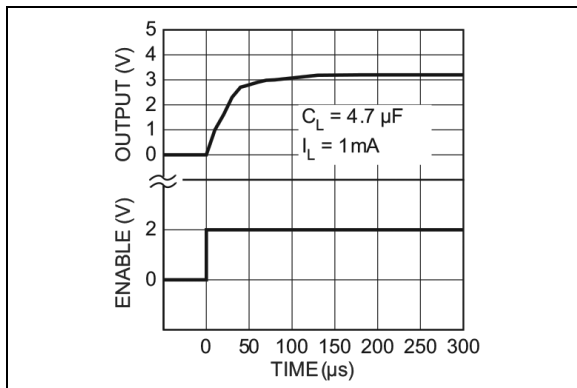
# MIC5201



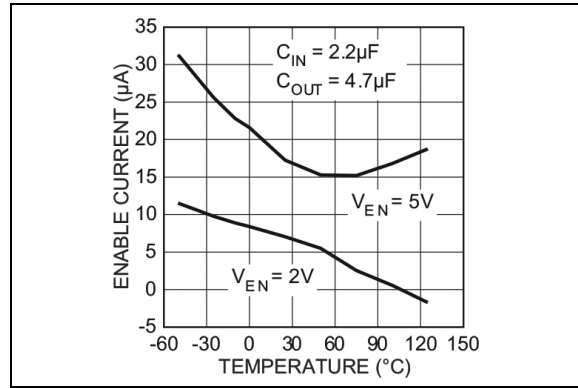
**FIGURE 2-19:** Supply Current vs. Supply Voltage (3.3V Version).



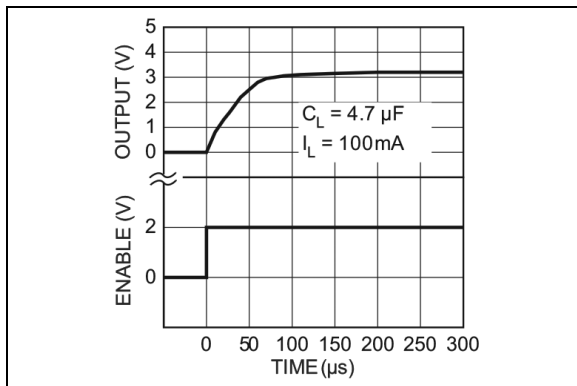
**FIGURE 2-22:** Output Impedance.



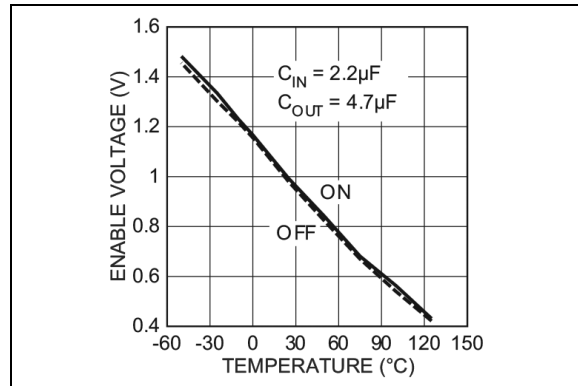
**FIGURE 2-20:** Enable Transient (3.3V Version).



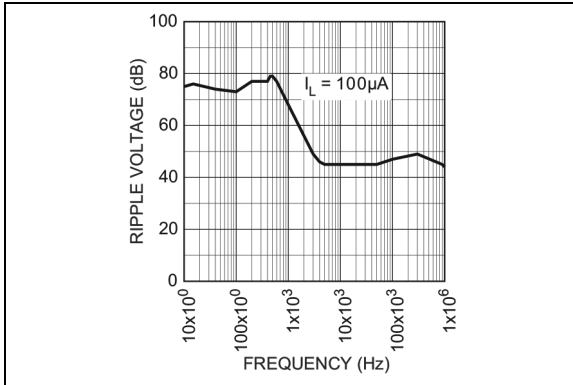
**FIGURE 2-23:** Enable Current Threshold vs. Temperature.



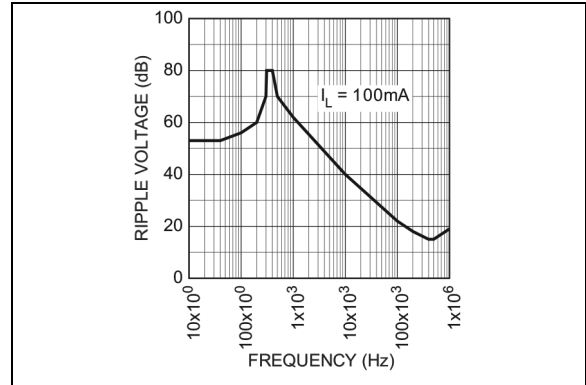
**FIGURE 2-21:** Enable Transient (3.3V Version).



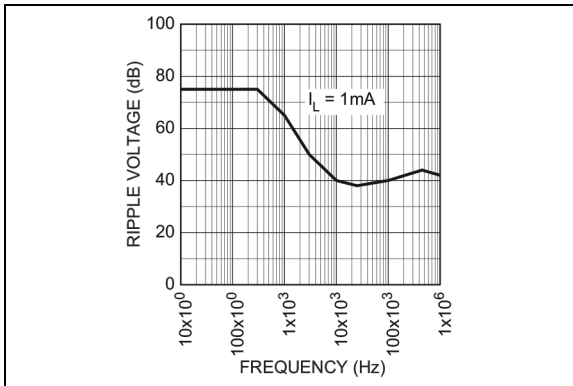
**FIGURE 2-24:** Enable Voltage Threshold vs. Temperature.



**FIGURE 2-25:** *Ripple vs. Frequency.*



**FIGURE 2-27:** *Ripple vs. Frequency.*



**FIGURE 2-26:** *Ripple vs. Frequency.*

# MIC5201

---

## 3.0 PIN DESCRIPTIONS

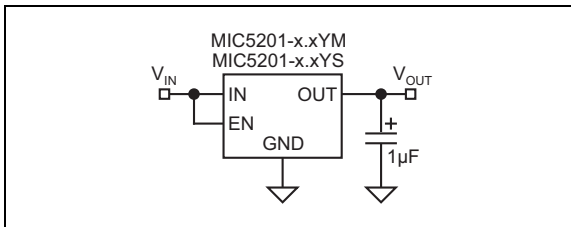
The descriptions of the pins are listed in [Table 3-1](#).

**TABLE 3-1: PIN FUNCTION TABLE**

Pin Number SOT-223	Pin Number 8-Lead SOIC (Adj.)	Pin Number 8-Lead SOIC (Fixed)	Pin Name	Description
3	1	1	OUT	Regulated output.
—	2	—	ADJ	Feedback input. Adjustable version only.
—	4, 6, 7	2, 4, 6, 7	NC	Not internally connected. Connect to ground plane for lowest thermal resistance.
2	3	3	GND	Ground.
—	5	5	EN	Enable (input): High = enable. Low or open = off/disable.
1	8	8	V <sub>IN</sub>	Unregulated supply input.

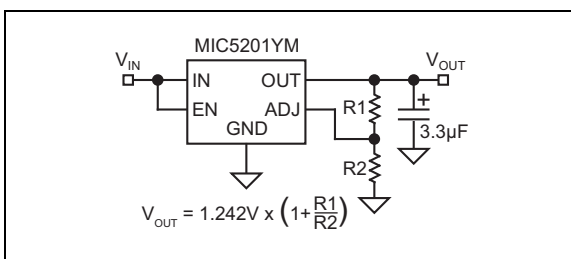
## 4.0 APPLICATIONS INFORMATION

Figure 4-1 shows a basic fixed voltage application with the unused enable input connected to  $V_{IN}$ .



**FIGURE 4-1:** Fixed Application.

Adjustable regulators require two resistors to set the output voltage. See Figure 4-2.



**FIGURE 4-2:** Adjustable Application.

Resistor values are not critical because ADJ (adjust) has a high-impedance, but for best results, use resistors of 470 kΩ or less.

### 4.1 Output Capacitors

A 1 μF capacitor is recommended between the MIC5201 output and ground to prevent oscillations due to instability. Larger values serve to improve the regulator's transient response. Most types of tantalum or aluminum electrolytics will be adequate; film types will work, but are costly and therefore not recommended. Many aluminum electrolytics have electrolytes that freeze at about -30°C, so solid tantalums are recommended for operation below -25°C. The important parameters of the capacitor are an effective series resistance of about 5Ω or less and a resonant frequency above 500 kHz. The value of this capacitor may be increased without limit.

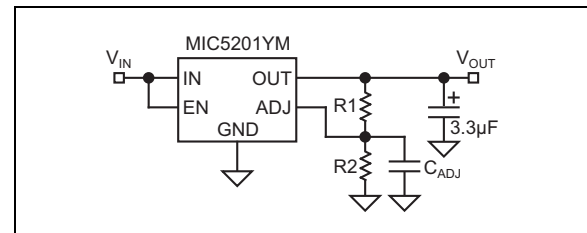
At lower values of output current, less output capacitance is required for output stability. The capacitor can be reduced to 0.47 μF for current below 10 mA or 0.33 μF for currents below 1 mA.

### 4.2 Input Capacitors

A 1 μF capacitor should be placed from the MIC5201 input to ground if there is more than ten inches of wire between the input and the AC filter capacitor, or if a battery is used as the input.

### 4.3 Noise Reduction Capacitors

On adjustable devices, a capacitor from ADJ to GND will decrease high-frequency noise on the output. See Figure 4-3.



**FIGURE 4-3:** Decreasing Output Noise.

### 4.4 Minimum Load

The MIC5201 will remain stable and in regulation with no load unlike many other voltage regulators. This is especially important in CMOS RAM keep-alive applications.

### 4.5 Dual Supply Systems

When used in dual supply systems, where the regulator load is returned to a negative supply, the output voltage must be diode clamped to ground.

### 4.6 Thermal Considerations Layout

The MIC5201-x.xYM (8-pin surface mount package) has the following thermal characteristics when mounted on a single layer copper-clad Printed Circuit Board (PCB).

**TABLE 4-1: THERMAL CHARACTERISTICS**

PCB Dielectric	$\theta_{JA}$
FR4	160°C/W
Ceramic	120°C/W

Multilayer boards having a ground plane, wide traces near the pads and large supply bus lines provide better thermal conductivity.

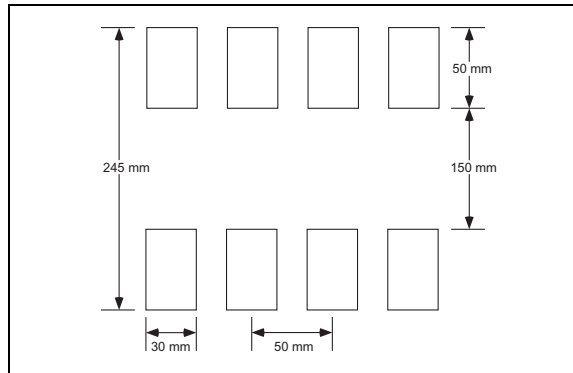
The “worst-case” value of 160°C/W assumes no ground plane, minimum trace widths and a FR4 material board.

# MIC5201

## 4.7 Nominal Power Dissipation and Die Temperature

The MIC5201-x.xYM at a +25°C ambient temperature will operate reliably at up to 625 mW power dissipation when mounted in the “worst-case” manner described above. At an ambient temperature of +55°C, the device may safely dissipate 440 mW. These power levels are equivalent to a die temperature of +125°C, the recommended maximum temperature for non-military grade silicon integrated circuits.

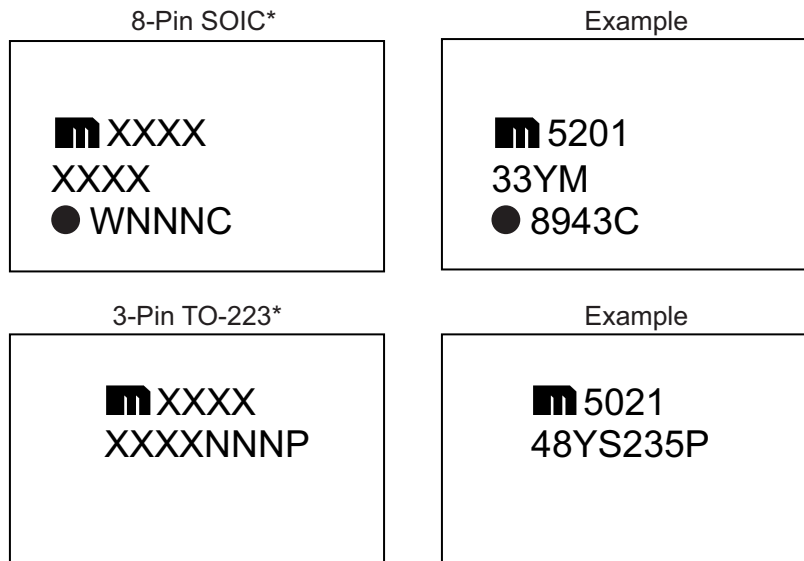
For MIC5201-x.xYS (SOT-223 package) heat sink characteristics, please refer to [Application Hint 17, P.C. Board Heat Sinking](#).



**FIGURE 4-4:** Minimum Recommended 8-Lead SOIC PCB Pads Size.

## 5.0 PACKAGING INFORMATION

### 5.1 Package Marking Information



<p><b>Legend:</b></p> <p>XX...X Product code or customer-specific information</p> <p>Y Year code (last digit of calendar year)</p> <p>YY Year code (last 2 digits of calendar year)</p> <p>WW Week code (week of January 1 is week '01')</p> <p>NNN Alphanumeric traceability code</p> <p>Ⓔ Pb-free JEDEC® designator for Matte Tin (Sn)</p> <p>* This package is Pb-free. The Pb-free JEDEC designator (Ⓔ3) can be found on the outer packaging for this package.</p> <p>●, ▲, ▼ Pin one index is identified by a dot, delta up, or delta down (triangle mark).</p>
<p><b>Note:</b> In the event the full Microchip part number cannot be marked on one line, it will be carried over to the next line, thus limiting the number of available characters for customer-specific information. Package may or may not include the corporate logo.</p> <p>Underbar ( _ ) and/or Overbar ( ¯ ) symbol may not be to scale.</p>

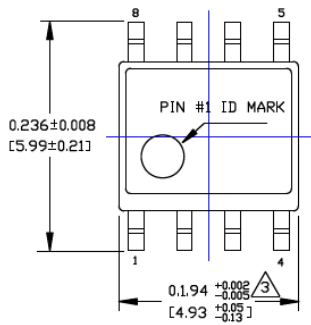
# MIC5201

## 8-Lead SOIC Package Outline and Recommended Land Pattern

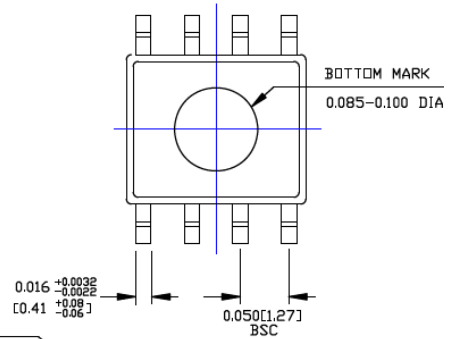
**TITLE**

8 LEAD SOICN PACKAGE OUTLINE & RECOMMENDED LAND PATTERN

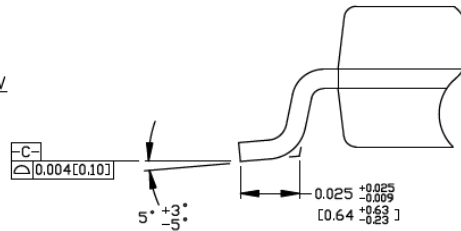
DRAWING #	SOICN-8LD-PL-1	UNIT	INCH [MM]
-----------	----------------	------	-----------



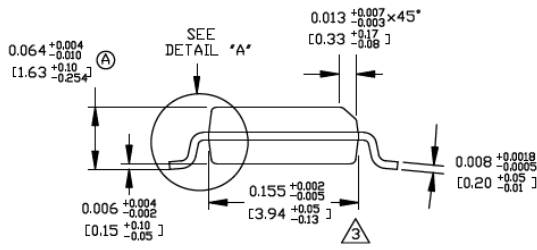
TOP VIEW



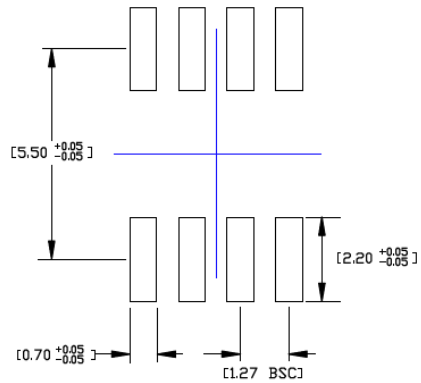
BOTTOM VIEW



DETAIL "A"



END VIEW



RECOMMENDED LAND PATTERN

**NOTES:**

1. DIMENSIONS ARE IN INCHES[MM].
2. CONTROLLING DIMENSION: INCHES.
3. DIMENSION DOES NOT INCLUDE MOLD FLASH OR PROTRUSIONS, EITHER OF WHICH SHALL NOT EXCEED 0.010[0.25] PER SIDE.

Note: For the most current package drawings, please see the Microchip Packaging Specification located at <http://www.microchip.com/packaging>.

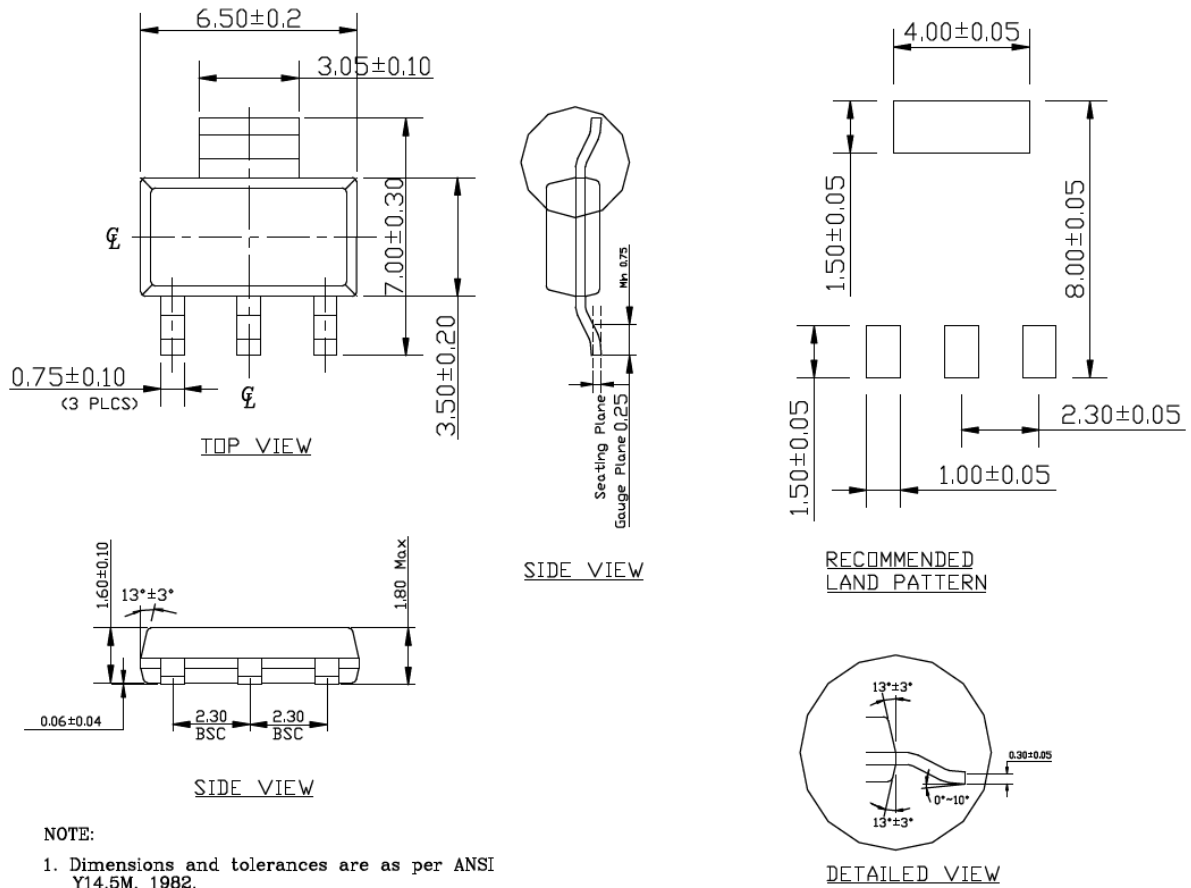


## 3-Lead TO-223 Package Outline and Recommended Land Pattern

**TITLE**

3 LEAD SOT223 PACKAGE OUTLINE & RECOMMENDED LAND PATTERN

DRAWING #	SOT223-3LD-PL-1	UNIT	MM
-----------	-----------------	------	----



**NOTE:**

1. Dimensions and tolerances are as per ANSI Y14.5M, 1982.
2. Controlling dimension: Millimeters.
3. Dimensions are exclusive of mold flash and gate burr.
4. All specification comply to Jedec spec TO261 Issue C.

Note: For the most current package drawings, please see the Microchip Packaging Specification located at <http://www.microchip.com/packaging>.

# MIC5201

---

NOTES:

## APPENDIX A: REVISION HISTORY

### Revision B (July 2020)

- Updated [Features](#) section.
- Updated [Table 1-1](#).
- Updated [Product Identification System](#) section.

### Revision A (February 2017)

- Converted Micrel document MIC5201 to Microchip data sheet DS20005718B.
- Minor text changes throughout.
- Removed all reference to discontinued leaded parts.
- Added  $\theta_{JA}$  value for SOT-223 package in Temperature Specifications section.

# MIC5201

---

NOTES:

## PRODUCT IDENTIFICATION SYSTEM

To order or obtain information, e.g., on pricing or delivery, contact your local Microchip representative or sales office.

PART NO.		-	XX	X	X	-	XXX
Device	Voltage		Junction Temperature Range	Package			Media Type
<b>Device:</b>	MIC5201:		150 mA Low-Dropout Regulator				
<b>Voltage:</b>	(blank) = Adjustable (M package only)						
	3.0 = 3.0V						
	3.3 = 3.3V						
	4.8 = 4.8V (S package only)						
	5.0 = 5.0V						
<b>Junction Temperature Range:</b>	Y = -40°C to +85°C						
<b>Package:</b>	M = 8-Lead SOIC						
	S = 3-Lead SOT-223						
<b>Media Type:</b>	TR = 4,000/Reel for S Package (Automotive)						
	Tube = 78/Tube for S Package (Automotive)						
	TR = 3,300/Reel for M Package (Automotive)						
	Tube = 100/Tube for M Package (Automotive)						
	TR = 2,500/Reel for S Package (Commercial)						
	Tube = 78/Tube for S Package (Commercial)						
	TR = 2,500/Reel for M Package (Commercial)						
	Tube = 95/Tube for M Package (Commercial)						
<b>Qualification:</b>	(blank) = Standard Qualification						
	VAO = AEC-Q100 Automotive Qualification						
	Vxx = AEC-Q100 Automotive Qualification, custom device, additional terms or conditions may apply						
<b>Examples:</b>							
a)	MIC5201YM:		150 mA Low-Dropout Regulator, Adjustable Voltage, 8-Lead SOIC, -40°C to +85°C Junction Temperature Range, 95/Tube				
b)	MIC5201-3.0YM-TR:		150 mA Low-Dropout Regulator, 3.0V Voltage, 8-Lead SOIC, -40°C to +85°C Junction Temperature Range, 2,500/Reel				
c)	MIC5201-3.3YM:		150 mA Low-Dropout Regulator, 3.3V Voltage, 8-Lead SOIC, -40°C to +85°C Junction Temperature Range, 95/Tube				
d)	MIC5201-5.0YM-TR:		150 mA Low-Dropout Regulator, 5.0V Voltage, 8-Lead SOIC, -40°C to +85°C Junction Temperature Range, 2,500/Reel				
e)	MIC5201-3.0YS:		150 mA Low-Dropout Regulator, 3.0V Voltage, 3-Lead SOT-223, -40°C to +85°C Junction Temperature Range, 78/Tube				
f)	MIC5201-3.3YS-TR:		150 mA Low-Dropout Regulator, 3.3V Voltage, 3-Lead SOT-223, -40°C to +85°C Junction Temperature Range, 2,500/Reel				
g)	MIC5201-4.8YS:		150 mA Low-Dropout Regulator, 4.8V Voltage, 3-Lead SOT-223, -40°C to +85°C Junction Temperature Range, 78/Tube				
h)	MIC5201-5.0YS-TR:		150 mA Low-Dropout Regulator, 5.0V Voltage, 3-Lead SOT-223, -40°C to +85°C Junction Temperature Range, 2,500/Reel				
i)	MIC5201-5.0YM-TRVAO:		150 mA Low-Dropout Regulator, 5.0V Voltage, 8-Lead SOIC, -40°C to +85°C Junction Temperature Range, 3,300/Reel				
j)	MIC5201-3.3YM-TRVAO:		150 mA Low-Dropout Regulator, 3.3V Voltage, 8-Lead SOIC, -40°C to +85°C Junction Temperature Range, 3,300/Reel				
k)	MIC5201-5.0YS-TRVAO:		150 mA Low-Dropout Regulator, 5.0V Voltage, 3-Lead SOT-223, -40°C to +85°C Junction Temperature Range, 4,000/Reel				
l)	MIC5201-3.3YS-TRVAO:		150 mA Low-Dropout Regulator, 3.3V Voltage, 3-Lead SOT-223, -40°C to +85°C Junction Temperature Range, 4,000/Reel				
<b>Note 1:</b> Tape and Reel identifier only appears in the catalog part number description. This identifier is used for ordering purposes and is not printed on the device package. Check with your Microchip Sales Office for package availability with the Tape and Reel option.							

# MIC5201

---

NOTES:

---

**Note the following details of the code protection feature on Microchip devices:**

- Microchip products meet the specification contained in their particular Microchip Data Sheet.
- Microchip believes that its family of products is one of the most secure families of its kind on the market today, when used in the intended manner and under normal conditions.
- There are dishonest and possibly illegal methods used to breach the code protection feature. All of these methods, to our knowledge, require using the Microchip products in a manner outside the operating specifications contained in Microchip's Data Sheets. Most likely, the person doing so is engaged in theft of intellectual property.
- Microchip is willing to work with the customer who is concerned about the integrity of their code.
- Neither Microchip nor any other semiconductor manufacturer can guarantee the security of their code. Code protection does not mean that we are guaranteeing the product as “unbreakable.”

Code protection is constantly evolving. We at Microchip are committed to continuously improving the code protection features of our products. Attempts to break Microchip's code protection feature may be a violation of the Digital Millennium Copyright Act. If such acts allow unauthorized access to your software or other copyrighted work, you may have a right to sue for relief under that Act.

---

Information contained in this publication regarding device applications and the like is provided only for your convenience and may be superseded by updates. It is your responsibility to ensure that your application meets with your specifications. MICROCHIP MAKES NO REPRESENTATIONS OR WARRANTIES OF ANY KIND WHETHER EXPRESS OR IMPLIED, WRITTEN OR ORAL, STATUTORY OR OTHERWISE, RELATED TO THE INFORMATION, INCLUDING BUT NOT LIMITED TO ITS CONDITION, QUALITY, PERFORMANCE, MERCHANTABILITY OR FITNESS FOR PURPOSE. Microchip disclaims all liability arising from this information and its use. Use of Microchip devices in life support and/or safety applications is entirely at the buyer's risk, and the buyer agrees to defend, indemnify and hold harmless Microchip from any and all damages, claims, suits, or expenses resulting from such use. No licenses are conveyed, implicitly or otherwise, under any Microchip intellectual property rights unless otherwise stated.

#### **Trademarks**

The Microchip name and logo, the Microchip logo, Adaptec, AnyRate, AVR, AVR logo, AVR Freaks, BesTime, BitCloud, chipKIT, chipKIT logo, CryptoMemory, CryptoRF, dsPIC, FlashFlex, flexPWR, HELDO, IGLOO, JukeBlox, KeeLoq, Klear, LANCheck, LinkMD, maXStylus, maXTouch, MediaLB, megaAVR, Microsemi, Microsemi logo, MOST, MOST logo, MPLAB, OptoLyzer, PackeTime, PIC, picoPower, PICSTART, PIC32 logo, PolarFire, Prochip Designer, QTouch, SAM-BA, SenGenuity, SpyNIC, SST, SST Logo, SuperFlash, Symmetricom, SyncServer, Tachyon, TempTracker, TimeSource, tinyAVR, UNI/O, Vectron, and XMEGA are registered trademarks of Microchip Technology Incorporated in the U.S.A. and other countries.

APT, ClockWorks, The Embedded Control Solutions Company, EtherSynch, FlashTec, Hyper Speed Control, HyperLight Load, IntelliMOS, Libero, motorBench, mTouch, Powermite 3, Precision Edge, ProASIC, ProASIC Plus, ProASIC Plus logo, Quiet-Wire, SmartFusion, SyncWorld, Temux, TimeCesium, TimeHub, TimePictra, TimeProvider, Vite, WinPath, and ZL are registered trademarks of Microchip Technology Incorporated in the U.S.A.

Adjacent Key Suppression, AKS, Analog-for-the-Digital Age, Any Capacitor, AnyIn, AnyOut, BlueSky, BodyCom, CodeGuard, CryptoAuthentication, CryptoAutomotive, CryptoCompanion, CryptoController, dsPICDEM, dsPICDEM.net, Dynamic Average Matching, DAM, ECAN, EtherGREEN, In-Circuit Serial Programming, ICSP, INICnet, Inter-Chip Connectivity, JitterBlocker, KlearNet, KlearNet logo, memBrain, Mindi, MiWi, MPASM, MPF, MPLAB Certified logo, MPLIB, MPLINK, MultiTRAK, NetDetach, Omniscient Code Generation, PICDEM, PICDEM.net, PICkit, PICtail, PowerSmart, PureSilicon, QMatrix, REAL ICE, Ripple Blocker, SAM-ICE, Serial Quad I/O, SMART-I.S., SQI, SuperSwitcher, SuperSwitcher II, Total Endurance, TSHARC, USBCheck, VariSense, ViewSpan, WiperLock, Wireless DNA, and ZENA are trademarks of Microchip Technology Incorporated in the U.S.A. and other countries.

SQTP is a service mark of Microchip Technology Incorporated in the U.S.A.

The Adaptec logo, Frequency on Demand, Silicon Storage Technology, and Symmcom are registered trademarks of Microchip Technology Inc. in other countries.

GestIC is a registered trademark of Microchip Technology Germany II GmbH & Co. KG, a subsidiary of Microchip Technology Inc., in other countries.

All other trademarks mentioned herein are property of their respective companies.

© 2017-2020, Microchip Technology Incorporated, All Rights Reserved.

ISBN: 978-1-5224-6440-2

For information regarding Microchip's Quality Management Systems, please visit [www.microchip.com/quality](http://www.microchip.com/quality).



# MICROCHIP

## Worldwide Sales and Service

### AMERICAS

**Corporate Office**  
2355 West Chandler Blvd.  
Chandler, AZ 85224-6199  
Tel: 480-792-7200  
Fax: 480-792-7277  
Technical Support:  
<http://www.microchip.com/support>  
Web Address:  
[www.microchip.com](http://www.microchip.com)

#### Atlanta

Duluth, GA  
Tel: 678-957-9614  
Fax: 678-957-1455

#### Austin, TX

Tel: 512-257-3370

#### Boston

Westborough, MA  
Tel: 774-760-0087  
Fax: 774-760-0088

#### Chicago

Itasca, IL  
Tel: 630-285-0071  
Fax: 630-285-0075

#### Dallas

Addison, TX  
Tel: 972-818-7423  
Fax: 972-818-2924

#### Detroit

Novi, MI  
Tel: 248-848-4000

#### Houston, TX

Tel: 281-894-5983

#### Indianapolis

Noblesville, IN  
Tel: 317-773-8323  
Fax: 317-773-5453  
Tel: 317-536-2380

#### Los Angeles

Mission Viejo, CA  
Tel: 949-462-9523  
Fax: 949-462-9608  
Tel: 951-273-7800

#### Raleigh, NC

Tel: 919-844-7510

#### New York, NY

Tel: 631-435-6000

#### San Jose, CA

Tel: 408-735-9110  
Tel: 408-436-4270

#### Canada - Toronto

Tel: 905-695-1980  
Fax: 905-695-2078

### ASIA/PACIFIC

**Australia - Sydney**  
Tel: 61-2-9868-6733

**China - Beijing**  
Tel: 86-10-8569-7000

**China - Chengdu**  
Tel: 86-28-8665-5511

**China - Chongqing**  
Tel: 86-23-8980-9588

**China - Dongguan**  
Tel: 86-769-8702-9880

**China - Guangzhou**  
Tel: 86-20-8755-8029

**China - Hangzhou**  
Tel: 86-571-8792-8115

**China - Hong Kong SAR**  
Tel: 852-2943-5100

**China - Nanjing**  
Tel: 86-25-8473-2460

**China - Qingdao**  
Tel: 86-532-8502-7355

**China - Shanghai**  
Tel: 86-21-3326-8000

**China - Shenyang**  
Tel: 86-24-2334-2829

**China - Shenzhen**  
Tel: 86-755-8864-2200

**China - Suzhou**  
Tel: 86-186-6233-1526

**China - Wuhan**  
Tel: 86-27-5980-5300

**China - Xian**  
Tel: 86-29-8833-7252

**China - Xiamen**  
Tel: 86-592-2388138

**China - Zhuhai**  
Tel: 86-756-3210040

### ASIA/PACIFIC

**India - Bangalore**  
Tel: 91-80-3090-4444

**India - New Delhi**  
Tel: 91-11-4160-8631

**India - Pune**  
Tel: 91-20-4121-0141

**Japan - Osaka**  
Tel: 81-6-6152-7160

**Japan - Tokyo**  
Tel: 81-3-6880-3770

**Korea - Daegu**  
Tel: 82-53-744-4301

**Korea - Seoul**  
Tel: 82-2-554-7200

**Malaysia - Kuala Lumpur**  
Tel: 60-3-7651-7906

**Malaysia - Penang**  
Tel: 60-4-227-8870

**Philippines - Manila**  
Tel: 63-2-634-9065

**Singapore**  
Tel: 65-6334-8870

**Taiwan - Hsin Chu**  
Tel: 886-3-577-8366

**Taiwan - Kaohsiung**  
Tel: 886-7-213-7830

**Taiwan - Taipei**  
Tel: 886-2-2508-8600

**Thailand - Bangkok**  
Tel: 66-2-694-1351

**Vietnam - Ho Chi Minh**  
Tel: 84-28-5448-2100

### EUROPE

**Austria - Wels**  
Tel: 43-7242-2244-39  
Fax: 43-7242-2244-393

**Denmark - Copenhagen**  
Tel: 45-4485-5910  
Fax: 45-4485-2829

**Finland - Espoo**  
Tel: 358-9-4520-820

**France - Paris**  
Tel: 33-1-69-53-63-20  
Fax: 33-1-69-30-90-79

**Germany - Garching**  
Tel: 49-8931-9700

**Germany - Haan**  
Tel: 49-2129-3766400

**Germany - Heilbronn**  
Tel: 49-7131-72400

**Germany - Karlsruhe**  
Tel: 49-721-625370

**Germany - Munich**  
Tel: 49-89-627-144-0  
Fax: 49-89-627-144-44

**Germany - Rosenheim**  
Tel: 49-8031-354-560

**Israel - Ra'anana**  
Tel: 972-9-744-7705

**Italy - Milan**  
Tel: 39-0331-742611  
Fax: 39-0331-466781

**Italy - Padova**  
Tel: 39-049-7625286

**Netherlands - Drunen**  
Tel: 31-416-690399  
Fax: 31-416-690340

**Norway - Trondheim**  
Tel: 47-7288-4388

**Poland - Warsaw**  
Tel: 48-22-3325737

**Romania - Bucharest**  
Tel: 40-21-407-87-50

**Spain - Madrid**  
Tel: 34-91-708-08-90  
Fax: 34-91-708-08-91

**Sweden - Gothenberg**  
Tel: 46-31-704-60-40

**Sweden - Stockholm**  
Tel: 46-8-5090-4654

**UK - Wokingham**  
Tel: 44-118-921-5800  
Fax: 44-118-921-5820



# Mouser Electronics

Authorized Distributor

Click to View Pricing, Inventory, Delivery & Lifecycle Information:

## Microchip:

[MIC5201-3.0YS](#) [MIC5201-5.0YS](#) [MIC5201-3.3YS](#) [MIC5201-5.0YM](#) [MIC5201-3.3YS TR](#) [MIC5201-3.3YM](#)  
[MIC5201YM](#) [MIC5201-4.8YS](#) [MIC5201-3.0YM](#) [MIC5201-4.8YS TR](#) [MIC5201-3.0YMM TR](#) [MIC5201YM TR](#) [MIC5201-](#)  
[3.0YS TR](#) [MIC5201-4.8YM TR](#) [MIC5201-3.3YM TR](#) [MIC5201-5.0YS TR](#) [MIC5201-3.0YM TR](#) [MIC5201-3.0YMM](#)  
[MIC5201-5.0YM TR](#) [MIC5201-4.8YM](#) [MIC5201-3.0YM-TR](#) [MIC5201-3.3YS-TR](#) [MIC5201YM-TR](#) [MIC5201-5.0YM-TR](#)  
[MIC5201-5.0YS-TR](#) [MIC5201-4.8YS-TR](#) [MIC5201-3.0YMM-TR](#) [MIC5201-3.0YS-TR](#) [MIC5201-4.8YM-TR](#) [MIC5201-](#)  
[3.3YM-TR](#)