

DF005-G Thru. DF10-G

Reverse Voltage: 50 to 1000V

Forward Current: 1.0A

RoHS Device

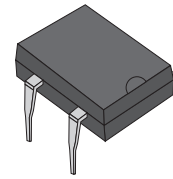

Features

- Rating to 1000V PRV.
- Ideal for printed circuit board.
- Low forward voltage drop.
- High current capability.
- The plastic material has UL flammability classification 94V-0
- UL recognized file # E349301

Mechanical Data

- Polarity: As marked on Body.
- Weight: 0.38 grams.
- Mounting position: Any.

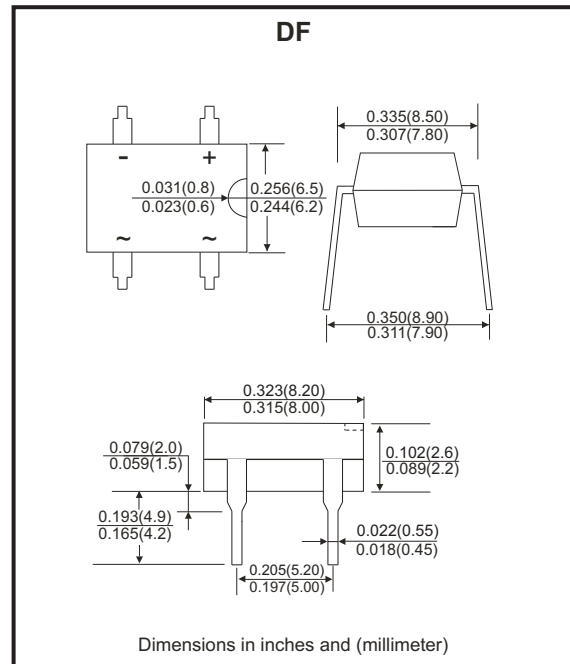

Maximum ratings and electrical characteristics

Rating at 25°C ambient temperature unless otherwise specified.
Single phase, half wave, 60Hz, resistive or inductive load.
For capacitive load, derate current by 20%

Parameter	Symbol	DF005-G	DF01-G	DF02-G	DF04-G	DF06-G	DF08-G	DF10-G	Unit
Maximum Recurrent Peak Reverse Voltage	V_{RRM}	50	100	200	400	600	800	1000	V
Maximum RMS Voltage	V_{RMS}	35	70	140	280	420	560	700	V
Maximum DC Blocking Voltage	V_{DC}	50	100	200	400	600	800	1000	V
Maximum Average Forward Rectified Current @ $T_A=40^\circ\text{C}$	$I_{(AV)}$	1.0							A
Peak Forward Surge Current, 8.3ms Single Half Sine-Wave Super Imposed on Rated Load	I_{FSM}	30							A
$I^2 t$ Rating for Fusing ($t < 8.3\text{ms}$)	$I^2 t$	3.735							A^2s
Maximum Forward Voltage at 1.0A DC	V_F	1.1							V
Maximum DC Reverse Current @ $T_J = 25^\circ\text{C}$ at Rated DC Blocking Voltage @ $T_J = 125^\circ\text{C}$	I_R	10 500							μA
Typical Junction Capacitance Per Element (Note 1)	C_J	25							pF
Typical Thermal Resistance (Note 2)	$R_{\theta JA}$	40							$^\circ\text{C}/\text{W}$
Operating Temperature Range	T_J	-55 ~ +150							$^\circ\text{C}$
Storage Temperature Range	T_{STG}	-55 ~ +150							$^\circ\text{C}$

Notes:

1. Measured at 1.0MHz and applied reverse voltage of 4.0V DC
2. Thermal resistance from junction to ambient mounted on P.C.B, with 0.50"×0.50" (13×13mm) copper pads.

Company reserves the right to improve product design, functions and reliability without notice.

REV: D

Rating and Characteristics Curves (DF005-G Thru. DF10-G)

Fig.1 - Forward Current Derating Curve

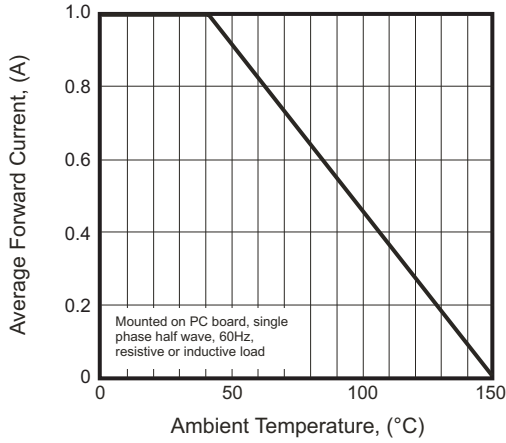

Fig.2 - Maximum Non-Repetitive Surge Current

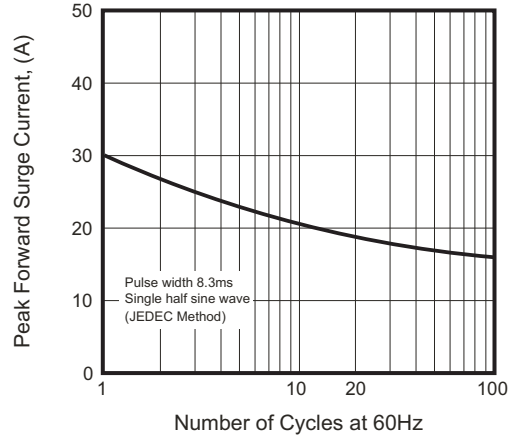

Fig.3 - Typical Junction Capacitance

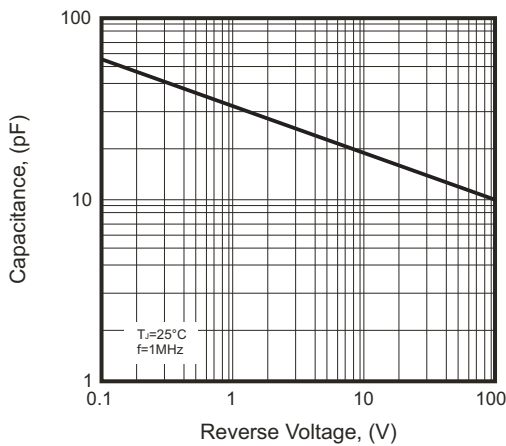

Fig.4 - Typical Forward Characteristics

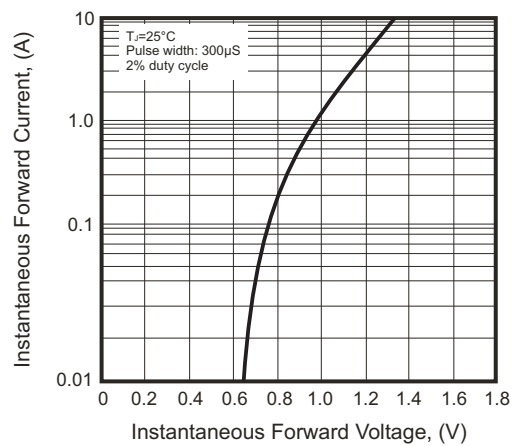
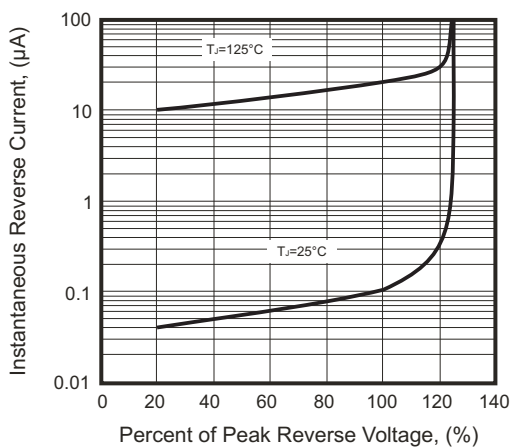

Fig.5 - Typical Reverse Characteristics



Company reserves the right to improve product design, functions and reliability without notice.

Marking Code

Part Number	Marking code
DF005-G	DF005
DF01-G	DF01
DF02-G	DF02
DF04-G	DF04
DF06-G	DF06
DF08-G	DF08
DF10-G	DF10

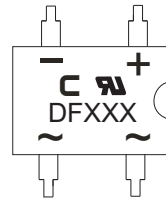

XX / XXX = Product type marking code
 C = Comchip Logo

Standard Packaging

Case Type	TUBE PACK	
	TUBE (pcs)	BOX (pcs)
DF	50	2,500

Mouser Electronics

Authorized Distributor

Click to View Pricing, Inventory, Delivery & Lifecycle Information:

[Comchip Technology:](#)

[DF04-G](#)