

Connector StarTOP® with SafeCONTACT - Part no. 35

- screwless, with insulation displacing technique
- SafeCONTACT
- cable gland and sealing
- strain relief and protection against kinking
- enclosure with thread lock and safety slide

Protection type	IP 44
Ampere	16A
Poles	5p
Voltage	400V
Hertz	50-60 Hz
Earth position	6h
Contact	standard
Connection technology	Screwless - SafeCONTACT

Std. Pack. 10 Qty.

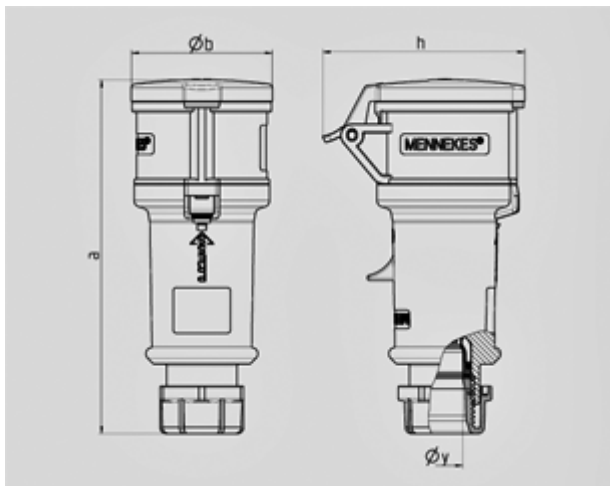

Drawing	Amp.	16			32		
		3	4	5	3	4	5
3 MB 60	Poles						
Dim. in mm	a	160	174	172	214	214	210
	b	57	61	69	75	75	80
	h	83	92	98	100	100	108
	y	16	16	16	22	22	22
Terminal for cond. cross		1	1	1	2,5	2,5	2,5
section (mm ²) min.-max.		-2,5	-2,5	-2,5	-6	-6	-6