

Monitoring Relays True RMS AC Current Transformer Types A 82-10, A 82-20, A 82-30

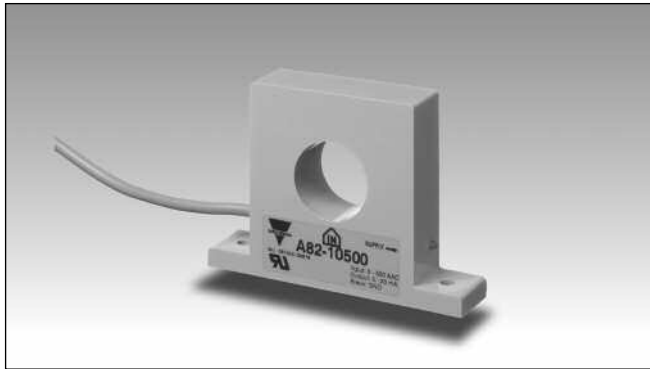

- 5 types of input:
 - 0 - 25 AAC
 - 0 - 50 AAC
 - 0 - 100 AAC
 - 0 - 250 AAC
 - 0 - 500 AAC
- Output:
 - A 82-10: 0 - 20 mADC (source)
 - A 82-20: 4 - 20 mADC (sink)
 - A 82-30: 0 - 10 VDC
- Easy interface to PLC or setpoint relays

Product Description

True RMS AC current metering transformer for 25, 50, 100, 250 or 500 AAC. Output current in accordance with IEC 60381-1 (A 82-10, A 82-20) or output voltage in accordance with IEC 60381-2 (A 82-30).
A 82-10 and A 82-20 can be used with relays DIB01, PIB01, DIC01 or PIC01.

A 82-30 can be used with DUB01, PUB01, DUB71, DUC01 or PUC01.
All units can be directly connected to a PLC. Power supply ON is indicated by a green LED on the side of the housing.

Ordering Key

A 82-10 50

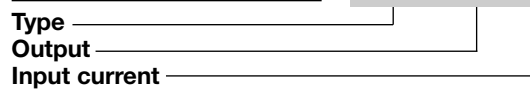

Type Selection

Input current	Output	Type no.
25 AAC	0 - 20 mA	A 82-10 25
50 AAC	0 - 20 mA	A 82-10 50
100 AAC	0 - 20 mA	A 82-10 100
250 AAC	0 - 20 mA	A 82-10 250
500 AAC	0 - 20 mA	A 82-10 500
25 AAC	4 - 20 mA	A 82-20 25
50 AAC	4 - 20 mA	A 82-20 50
100 AAC	4 - 20 mA	A 82-20 100
250 AAC	4 - 20 mA	A 82-20 250
500 AAC	4 - 20 mA	A 82-20 500
25 AAC	0 - 10 V	A 82-30 25
50 AAC	0 - 10 V	A 82-30 50
100 AAC	0 - 10 V	A 82-30 100
250 AAC	0 - 10 V	A 82-30 250
500 AAC	0 - 10 V	A 82-30 500

Input Specifications

	A 82-10/20/30 25	A 82-10/20/30 50	A 82-10/20/30 100	A 82-10/20/30 250	A 82-10/20/30 500
Current range	0 - 25 AAC	0 - 50 AAC	0 - 100 AAC	0 - 250 AAC	0 - 500 AAC
Max. current (continuously)	600 AAC	600 AAC	600 AAC	600 AAC	600 AAC
Max. overload current (t = 30 s)	3000 AAC	3000 AAC	3000 AAC	3000 AAC	3000 AAC
Rated insulation voltage Input - output	1000 VAC _{rms}	1000 VAC _{rms}	1000 VAC _{rms}	1000 VAC _{rms}	1000 VAC _{rms}
Overvoltage category	IV (IEC 60664)	IV (IEC 60664)	IV (IEC 60664)	IV (IEC 60664)	IV (IEC 60664)
Dielectric strength Dielectric voltage Rated impulse withstand volt.	6 kVAC _{rms} 12 kV (1.2/50 μs)	6 kVAC _{rms} 12 kV (1.2/50 μs)	6 kVAC _{rms} 12 kV (1.2/50 μs)	6 kVAC _{rms} 12 kV (1.2/50 μs)	6 kVAC _{rms} 12 kV (1.2/50 μs)



Output Specifications

Rated insulation voltage (cable)	250 VAC _{rms}	
Output	A 82-10	0 - 20 mADC
	A 82-20	4 - 20 mADC
	A 82-30	0 - 10 VDC
Power supply (loop voltage)	10 - 40 VDC	
	A 82-10, A 82-20	10 - 40 VDC
	A 82-30	18 - 40 VDC
Tolerance of output current @ 50 Hz	A 82-10	±2%
	A 82-20	± 2%
Tolerance of output voltage @ 50 Hz	A 82-30	±2%
Temperature variation	±400 ppm/°C	
Frequency range	40 Hz - 1 kHz	
Frequency variation	10 ppm/Hz	
Maximum output current	30 mADC	
	A 82-10, A 82-20	
Maximum output voltage	15 VDC	
	A 82-30	
Minimum output load	10 kΩ	
	A 82-30	

General Specifications

Power ON delay	< 2 s	
Reaction time	T < 200 ms	
Indication for Power supply ON	LED, green	
Environment	IP 40	
	Degree of protection	
	Pollution degree 3 (IEC 60664)	
	Operating temperature -20° to 50°C (-4° to +122 °F)	
Housing	95 x 67.5 x 20 mm	
	Dimensions	
	Material ABS	
Weight	A 82-10, A 82-30	300 g
	A 82-20	270 g
Connection cable	2 m, 3 x 0.25 mm ²	
	A 82-10, A 82-30	
	A 82-20	2 m, 2 x 0.25 mm ²
Approval	UL	
CE marking	Yes	
EMC	Electromagnetic Compatibility	
	Immunity According to EN 61000-6-1 (tolerance of output current/voltage: ± 2%)	
	According to EN 61000-6-2 (tolerance of output current/voltage: ± 5%)	
	Emission According to EN 61000-6-3	

Mode of Operation

A 82-10 and A 82-20 are true RMS current metering transformers with standard source/sink output 0-20 mA / 4-20 mA, whereas A 82-30 is a metering transformer with 0-10 VDC output voltage. This makes them very useful as an AC current interface to

a PLC with mADC or VDC input. Used with relays DIB01, PIB01, DIC01, PIC01 (A 82-10, A 82-20) or DUB01, PUB01, DUB71, DUC01, PUC01 (A 82-30), one or more setpoints can monitor the current and signal alarm.

The metered conductor is drawn through the central hole of the current metering transformer. It is possible to meter currents below the nominal range by drawing the conductor through the hole several times. If the conductor is drawn through

the central hole e.g. 5 times, the transformer will register 50 A when the current in the conductor is 10 A.

Input/Output Curve

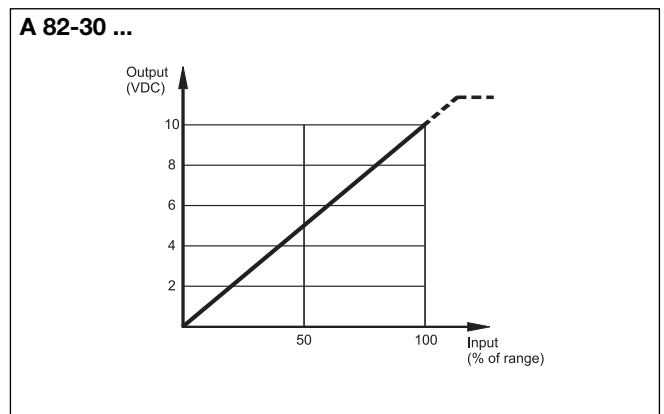
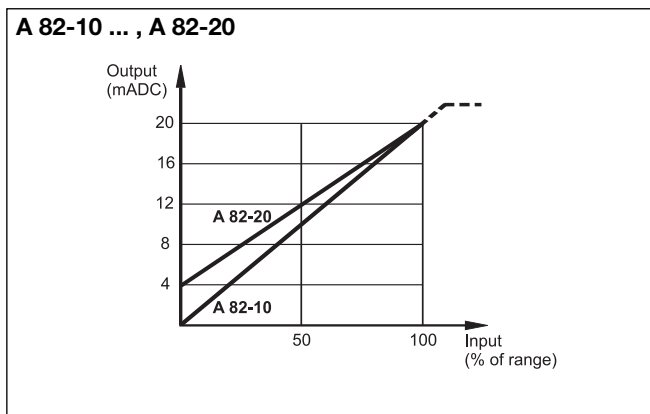

Resistance/Voltage Curve

A 82-10 ... , A 82-20
 (max. load resistance vs Power supply - Loop voltage)

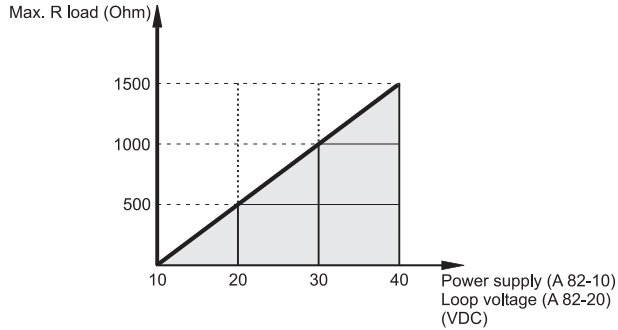

Wiring Diagrams

A 82-10 ... (source)

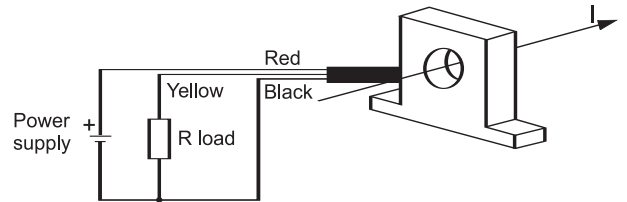

Wiring Diagrams (cont.)

A 82-20 ... (sink)

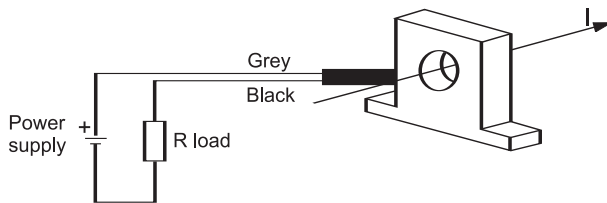

A 82-30 ...

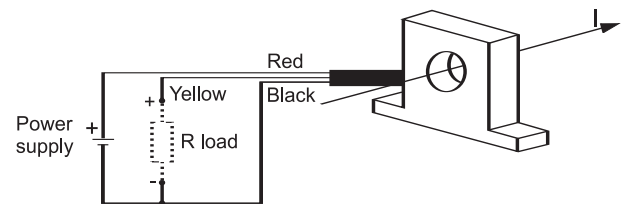

Dimensions

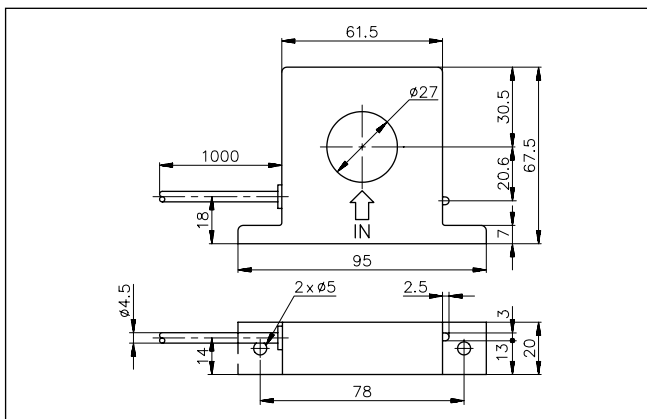

Mouser Electronics

Authorized Distributor

Click to View Pricing, Inventory, Delivery & Lifecycle Information:

Carlo Gavazzi:

[A82-10100](#) [A82-1025](#) [A82-10250](#) [A82-1050](#) [A82-10500](#) [A82-20100](#) [A82-30250](#) [A82-3050](#) [A82-30500](#) [A82-2025](#)
[A82-20250](#) [A82-2050](#) [A82-20500](#) [A82-30100](#) [A82-3025](#)