

FEATURES

44 V supply maximum rating
±15 V analog signal range
Low R_{ON} (60 Ω)
Low leakage (0.5 nA)
Break before make switching
Low power dissipation
Available in a 16-lead SOIC package
Replaces DG201A, HI-201

ENHANCED PRODUCT FEATURES

Supports defense and aerospace applications
(AQEC standard)
Military temperature range: -55°C to +125°C
Controlled manufacturing baseline
One assembly and test site
One fabrication site
Enhanced product change notification
Qualification data available on request

GENERAL DESCRIPTION

The ADG201A-EP is a monolithic CMOS device comprising four independently selectable switches. They are designed on an enhanced LC²MOS process, which gives an increased signal handling capability of ±15 V. These switches also feature high switching speeds and low R_{ON}.

The ADG201A-EP exhibits break before make switching action. Inherent in the design is low charge injection for minimum transients when switching the digital inputs.

Full details about this enhanced product are available in the [ADG201A](#) data sheet, which should be consulted in conjunction with this data sheet.

FUNCTIONAL BLOCK DIAGRAM

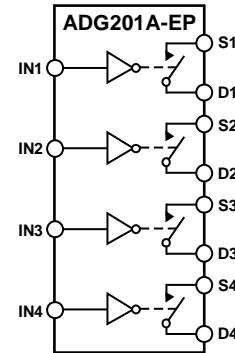

NOTES
 1. SWITCHES SHOWN FOR A LOGIC1 INPUT.

Figure 1.

09249-001

PRODUCT HIGHLIGHTS

1. Extended signal range of ±15 V.
2. Operates with 15 V single supply voltages.
3. Low leakage: 500 pA.

Table 1. Truth Table

IN _x	Switch Condition
0	On
1	Off

Rev. 0

Information furnished by Analog Devices is believed to be accurate and reliable. However, no responsibility is assumed by Analog Devices for its use, nor for any infringements of patents or other rights of third parties that may result from its use. Specifications subject to change without notice. No license is granted by implication or otherwise under any patent or patent rights of Analog Devices. Trademarks and registered trademarks are the property of their respective owners.

TABLE OF CONTENTS

Features	1	Dual Supply	3
Enhanced Product Features	1	Absolute Maximum Ratings	4
Functional Block Diagram	1	ESD Caution.....	4
General Description	1	Pin Configuration and Function Descriptions.....	5
Product Highlights	1	Test Circuits.....	6
Revision History	2	Outline Dimensions	7
Specifications.....	3	Ordering Guide	7

REVISION HISTORY

2/11—Revision 0: Initial Version

SPECIFICATIONS

DUAL SUPPLY

$V_{DD} = +15\text{ V} \pm 10\%$, $V_{SS} = -15\text{ V} \pm 10\%$, $GND = 0\text{ V}$. All specifications -55°C to $+125^{\circ}\text{C}$, unless otherwise noted.

Table 2.

Parameter	+25°C	-55°C to +125°C	Unit	Test Conditions/Comments
ANALOG SWITCH				
Analog Signal Range	±15	±15	V	
On Resistance (R_{ON})	60		Ω typ	$-10\text{ V} \leq V_S \leq +10\text{ V}$, $I_{DS} = 1\text{ mA}$; see Figure 3
	90	145	Ω max	
R_{ON} vs. $V_D(V_S)$	20		% typ	
R_{ON} Drift	0.5		%/°C typ	
R_{ON} Match	5		% typ	$V_S = 0\text{ V}$, $I_{DS} = 1\text{ mA}$
LEAKAGE CURRENTS				
Source Off Leakage, I_S (Off)	±0.5		nA typ	$V_D = \pm 14\text{ V}$, $V_S = \mp 14\text{ V}$; see Figure 4
	±2.0	±100	nA max	
Drain Off Leakage, I_D (Off)	±0.5		nA typ	$V_D = \pm 14\text{ V}$, $V_S = \mp 14\text{ V}$; see Figure 4
	±2.0	±100	nA max	
Channel On Leakage, I_D , I_S (On)	±0.5		nA typ	$V_D = \pm 14\text{ V}$; see Figure 5
	±2.0	±200	nA max	
DIGITAL INPUTS				
Input High Voltage, V_{INH}		2.4	V min	
Input Low Voltage, V_{INL}		0.8	V max	
Input Current, I_{INL} or I_{INH}		1	μA max	
DYNAMIC CHARACTERISTICS				
t_{OPEN}	30		ns typ	See Figure 6
t_{ON}^1	300		ns max	See Figure 6
t_{OFF}^1	250		ns max	See Figure 6
Off Isolation	80		dB typ	$V_S = 10\text{ V p-p}$, $f = 100\text{ kHz}$, $R_L = 75\ \Omega$; see Figure 8
Channel-to-Channel Crosstalk	80		dB typ	See Figure 9
C_S (Off)	5		pF typ	
C_D (Off)	5		pF typ	
C_D , C_S (On)	16		pF typ	
C_{IN} Digital input Capacitance	5		pF typ	
Q_{INJ} Charge Injection	20		pC typ	$R_S = 0\ \Omega$, $C_L = 1000\text{ pF}$, $V_S = 0\text{ V}$; see Figure 7
POWER SUPPLY				
I_{DD}	0.6		mA typ	Digital inputs = V_{INL} or V_{INH}
		2	mA max	
I_{SS}	0.1		mA typ	
		0.2	mA max	
Power Dissipation		33	mW max	

¹ Sample tested at 25°C to ensure compliance.

ABSOLUTE MAXIMUM RATINGS

T_A = 25°C, unless otherwise noted.

Table 3.

Parameter	Rating
V _{DD} to V _{SS}	44 V
V _{DD} to GND	25 V
V _{SS} to GND	-25 V
Analog Inputs ¹	V _{SS} - 0.3 V to V _{DD} + 0.3 V
Digital Inputs ¹	V _{SS} - 2 V to V _{DD} + 2 V or 20 mA (whichever occurs first)
Pulsed Current, S or D	70 mA (pulsed at 1 ms, 10% duty cycle maximum)
Continuous Current, S or D	30 mA
Operating Temperature Range	-55°C to +125°C
Storage Temperature Range	-65°C to +150°C
Power Dissipation	
Up to +75°C	470 mW
Derates above +75°C by	6 mW/°C
Lead Soldering	
Reflow, Peak Temperature	260 (+0/-5)°C
Time at Peak Temperature	20 sec to 40 sec

¹ Overvoltages at IN, S, or D are clamped by internal diodes. Current should be limited to the maximum ratings given.

Stresses above those listed under Absolute Maximum Ratings may cause permanent damage to the device. This is a stress rating only; functional operation of the device at these or any other conditions above those indicated in the operational section of this specification is not implied. Exposure to absolute maximum rating conditions for extended periods may affect device reliability.

Only one absolute maximum rating may be applied at a time.

ESD CAUTION



ESD (electrostatic discharge) sensitive device. Charged devices and circuit boards can discharge without detection. Although this product features patented or proprietary protection circuitry, damage may occur on devices subjected to high energy ESD. Therefore, proper ESD precautions should be taken to avoid performance degradation or loss of functionality.

PIN CONFIGURATION AND FUNCTION DESCRIPTIONS

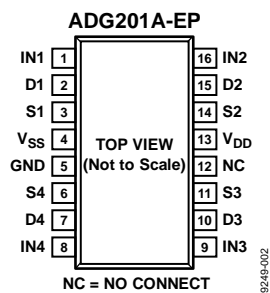

Figure 2. Pin Configuration

Table 4. Pin Function Descriptions

Pin No.	Mnemonic	Description
1	IN1	Logic Control Input.
2	D1	Drain Terminal. Can be an input or output.
3	S1	Source Terminal. Can be an input or output.
4	V _{SS}	Most Negative Power Supply. This pin is used in dual-supply applications only and should be tied to ground in single-supply applications.
5	GND	Ground (0 V) Reference.
6	S4	Source Terminal. Can be an input or output.
7	D4	Drain Terminal. Can be an input or output.
8	IN4	Logic Control Input.
9	IN3	Logic Control Input.
10	D3	Drain Terminal. Can be an input or output.
11	S3	Source Terminal. Can be an input or output.
12	NC	No Connect. Not internally connected.
13	V _{DD}	Most Positive Power Supply.
14	S2	Source Terminal. Can be an input or output.
15	D2	Drain Terminal. Can be an input or output.
16	IN2	Logic Control Input.

TEST CIRCUITS

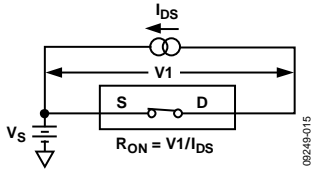

Figure 3. On Resistance

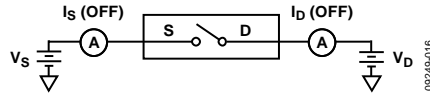

Figure 4. Off Leakage

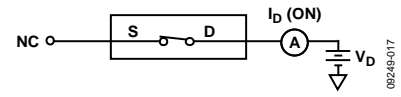

Figure 5. On Leakage

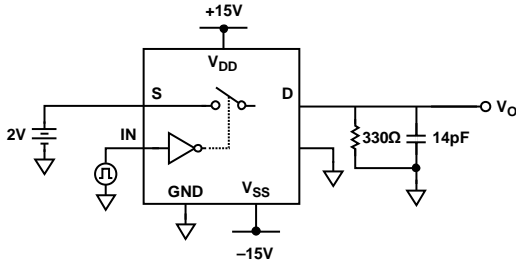

Figure 6. Switching Times

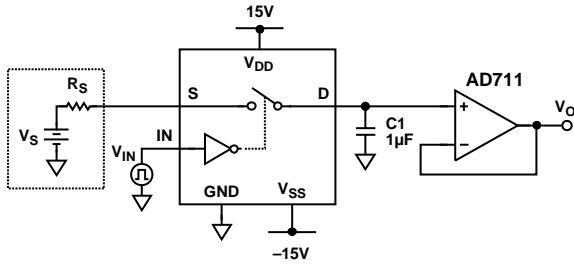
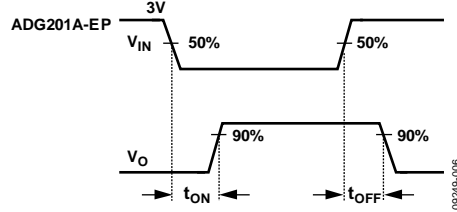

Figure 7. Charge Injection

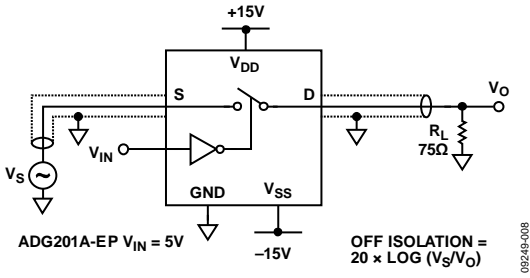
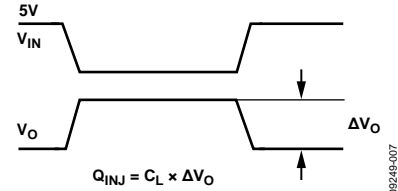

Figure 8. Off Isolation

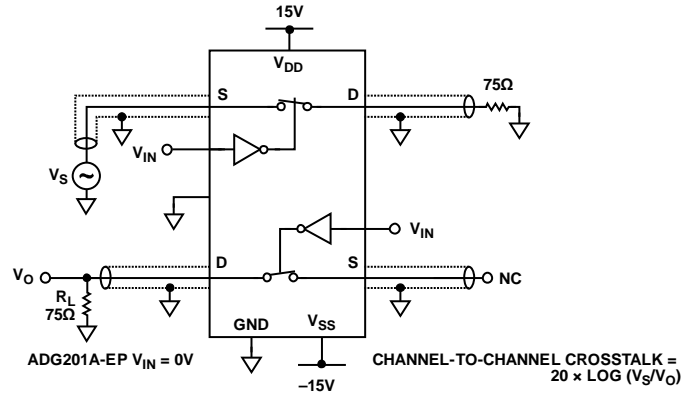
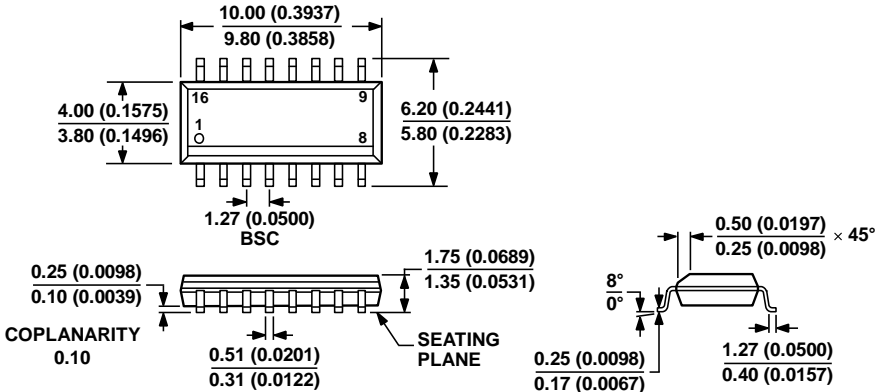

Figure 9. Channel-to-Channel Crosstalk

OUTLINE DIMENSIONS



COMPLIANT TO JEDEC STANDARDS MS-012-AC
 CONTROLLING DIMENSIONS ARE IN MILLIMETERS; INCH DIMENSIONS
 (IN PARENTHESES) ARE ROUNDED-OFF MILLIMETER EQUIVALENTS FOR
 REFERENCE ONLY AND ARE NOT APPROPRIATE FOR USE IN DESIGN.

060606-A

Figure 10. 16-Lead Standard Small Outline Package [SOIC_N]
 Narrow Body
 (R-16)

Dimensions shown in millimeters and (inches)

ORDERING GUIDE

Model ¹	Temperature Range	Package Description	Package Option
ADG201ASRZ-EP	-55°C to +125°C	16-Lead Standard Small Outline Package [SOIC_N]	R-16
ADG201ASRZ-EP-RL7	-55°C to +125°C	16-Lead Standard Small Outline Package [SOIC_N]	R-16

¹ Z =RoHS Compliant Part.

NOTES

Mouser Electronics

Authorized Distributor

Click to View Pricing, Inventory, Delivery & Lifecycle Information:

[Analog Devices Inc.:](#)

[ADG201ASRZ-EP](#) [ADG201AKPZ](#) [ADG201AKN](#) [ADG201AKNZ](#) [ADG201AKP](#) [ADG201AKRZ](#) [ADG201AKR](#)
[ADG201AKRZ-REEL7](#) [ADG201AKR-REEL7](#) [ADG201ASRZ-EP-RL7](#) [ADG201AKR-REEL](#) [ADG201AKRZ-REEL](#)
[ADG201AKPZ-REEL](#)