

Low Capacitance Quad Array for ESD Protection

General Description

Low capacitance 5-fold ESD protection array in the very small SOT363 plastic package designed to protect up to five transmission or data lines from the damage caused by Electrostatic Discharge (ESD).

Applications

- Cellular handsets and accessories
- Portable electronics
- Computers and peripherals
- Communications systems
- Audio and video equipment.

Features

- Uni-directional ESD protection of up to five lines
- Bi-directional ESD protection of up to four lines
- Low diode capacitance
- Low clamping voltage
- low leakage current
- IEC 61000-4-2; level 4 (ESD)
- IEC61000-4-5 (surge)
- S- Prefix for Automotive and Other Applications Requiring Unique Site and Control Change Requirements; AEC-Q101 Qualified and PPAP Capable.

LESDA5VAW6T1G
S-LESDA5VAW6T1G

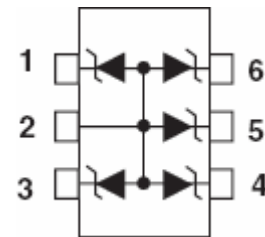
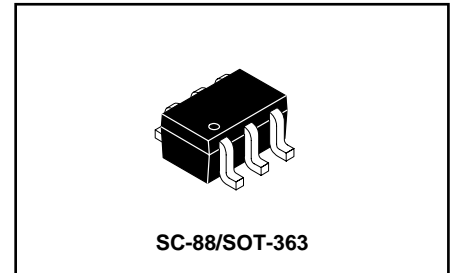

ORDERING INFORMATION

Device	Marking	Shipping
LESDA5VAW6T1G S-LESDA5VAW6T1G	K4	3000/Tape & Reel

Absolute Ratings (T_{amb}=25°C)

Symbol	Parameter	Value	Units
P _{PP}	Peak Pulse Power (t _p = 8/20μs)	25	W
T _L	Maximum lead temperature for soldering during 10s	260	°C
T _{stg}	Storage Temperature Range	-60 to +150	°C
T _{op}	Operating Temperature Range	-60 to +150	°C
T _j	Maximum junction temperature	150	°C
V _{PP}	Electrostatic discharge		
	IEC61000-4-2 (contact discharge)	8	kV
	IEC61000-4-2 (air discharge)	15	kV

LESDA5VAW6T1G , S-LESDA5VAW6T1G

Electrical Parameter

Symbol	Parameter
V_{RM}	Stand-off voltage
V_{BR}	Breakdown voltage
V_{CL}	Clamping voltage
I_R	Leakage current
I_{PP}	Peak pulse current
C	Capacitance

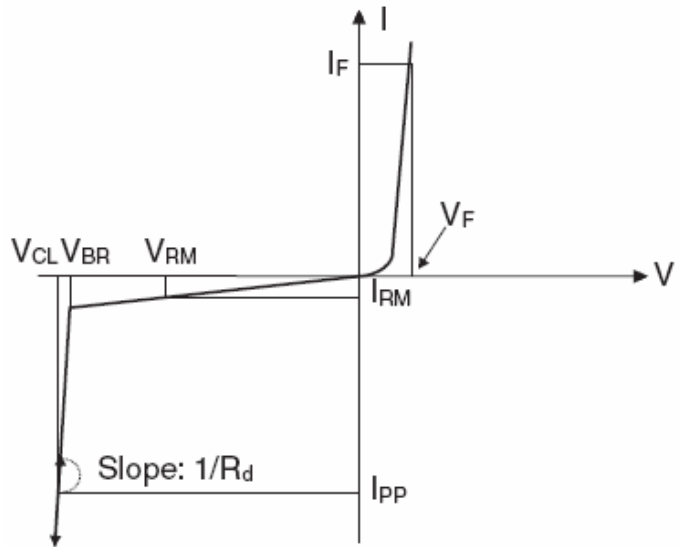

Electrical Characteristics

Part Numbers	V_{BR}		V_{RM}	I_R	I_{PP}	V_{CL} (Max)		C
	Min.	Max.				@ $I_{PP}=1A$	@ $I_{PP}=2.5A$	
LESDA5VAW6T1G	6.4 v	7.2 v	5 v	1 μA	2.5 A	10 v	12 v	15 pF

Notes

1. Non-repetitive current pulse 8/20 μs exponentially decaying waveform; see Fig.1.
2. Measured from any of pins 1, 3, 4, 5 or 6 to pin 2.

GRAPHICAL DATA

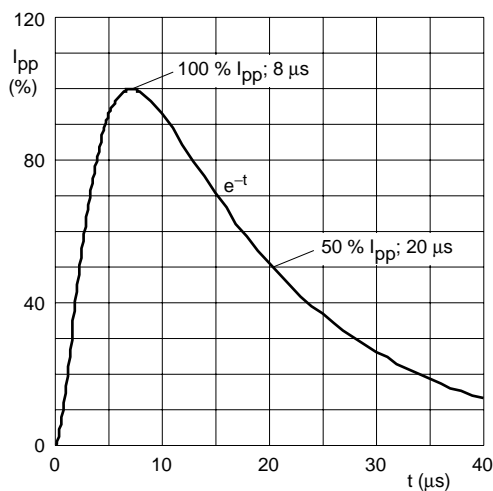

Fig.1 8/20 μs pulse waveform according to IEC 61000-4-5.

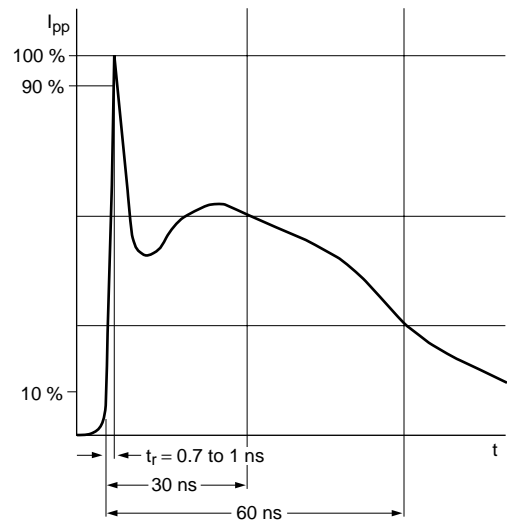
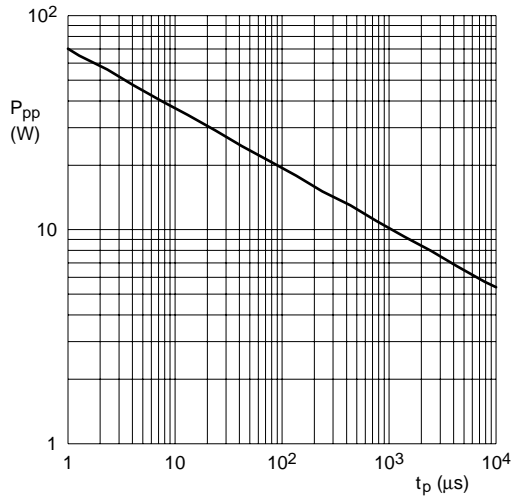

Fig.2 Electrostatic Discharge (ESD) pulse waveform according to IEC 61000-4-2.

LESDA5VAW6T1G , S-LESDA5VAW6T1G

GRAPHICAL DATA



$T_{amb} = 25\text{ }^{\circ}\text{C}$.
 $I_{pp} = 8/20\text{ }\mu s$ exponentially decaying waveform; see Fig.1.

Fig.3 Peak pulse power dissipation as a function of pulse time; typical values.

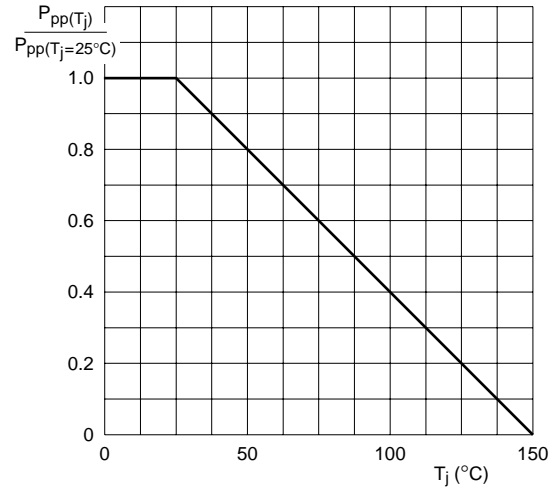
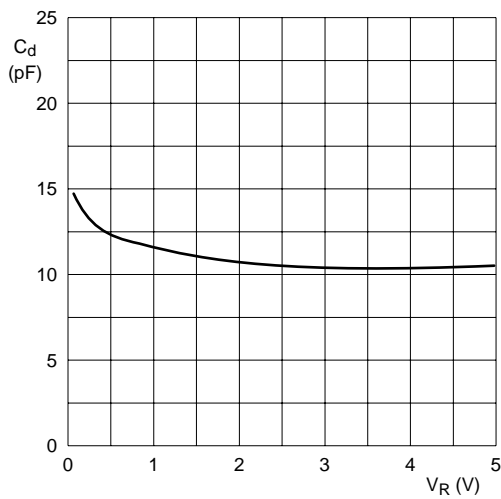

Fig.4 Relative variation of peak pulse power as a function of junction temperature; typical values.



$f = 1\text{ MHz}$; $T_{amb} = 25\text{ }^{\circ}\text{C}$.

Fig.5 Diode capacitance as a function of reverse voltage; typical values.

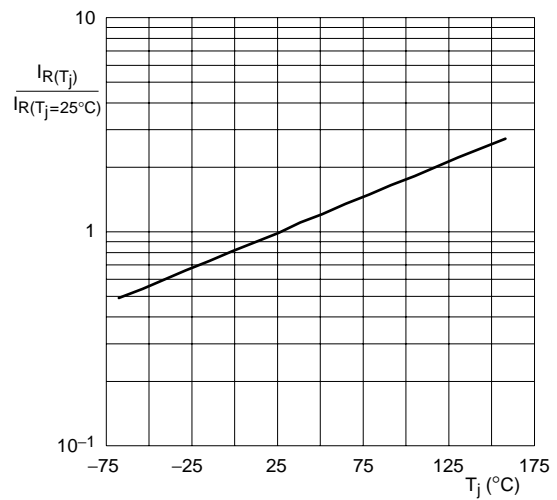
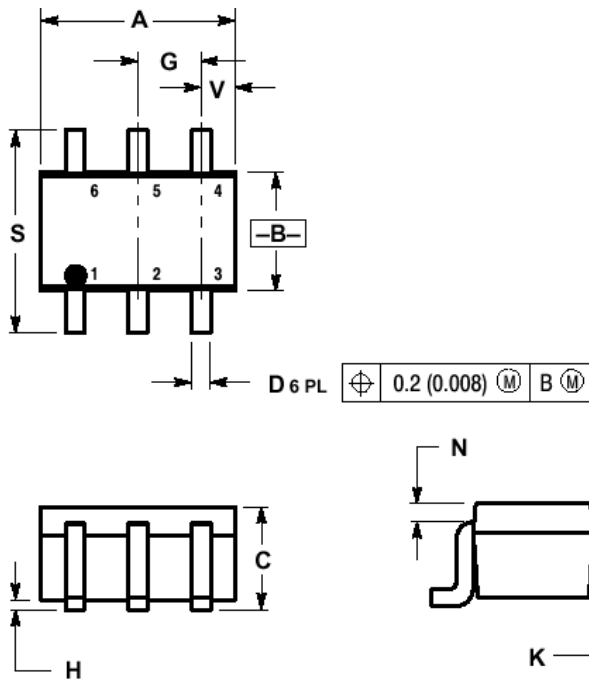

Fig.6 Relative variation of reverse leakage current as a function of junction temperature; typical values.

LESDA5VAW6T1G , S-LESDA5VAW6T1G

PACKAGE DIMENSIONS SC-88/SOT-363



NOTES:

1. DIMENSIONING AND TOLERANCING PER ANSI Y14.5M, 1982.
2. CONTROLLING DIMENSION: INCH.

DIM	INCHES		MILLIMETERS	
	MIN	MAX	MIN	MAX
A	0.071	0.087	1.80	2.20
B	0.045	0.053	1.15	1.35
C	0.031	0.043	0.80	1.10
D	0.004	0.012	0.10	0.30
G	0.026BSC		0.65BSC	
H	—	0.004	—	0.10
J	0.004	0.010	0.10	0.25
K	0.004	0.012	0.10	0.30
N	0.008 REF		0.20 REF	
S	0.079	0.087	2.00	2.20
V	0.012	0.016	0.30	0.40

EMBOSSED TAPE AND REEL DATA FOR DISCRETES

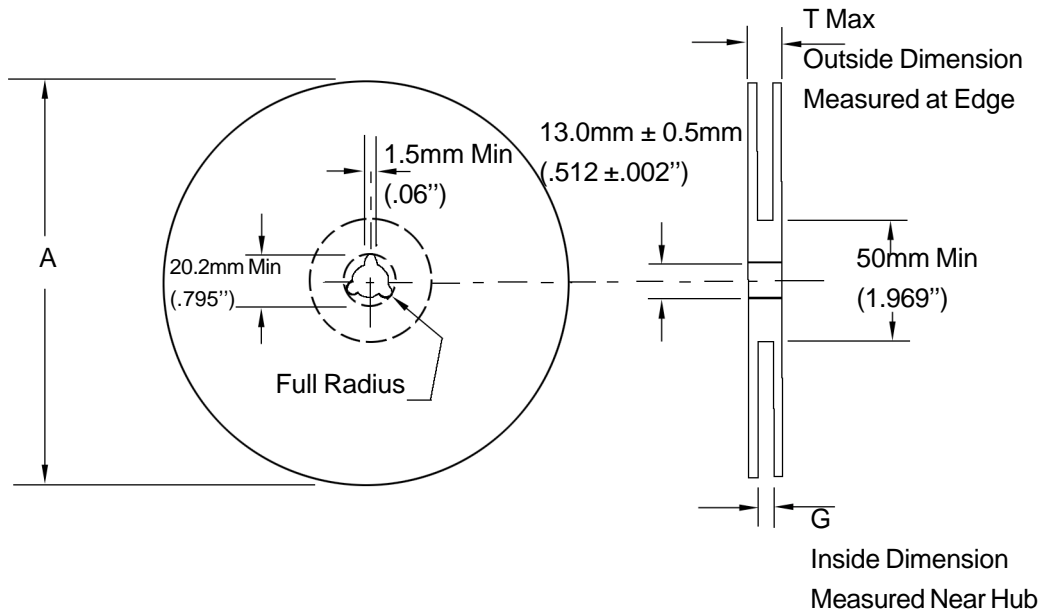

Size	A Max	G	T Max
8 mm	178.0mm (7.0")	8.4mm+1.5mm, -0.0 (.33"+.039", -0.00)	10.9mm (.43")

Reel Dimensions

Metric Dimensions Govern — English are in parentheses for reference only

Storage Conditions

Temperature: 5 to 40 Deg.C (20 to 30 Deg. C is preferred)

Humidity: 30 to 80 RH (40 to 60 is preferred)

Recommended Period: One year after manufacturing

(This recommended period is for the soldering condition only. The characteristics and reliabilities of the products are not restricted to this limitation)

Shipment Specification

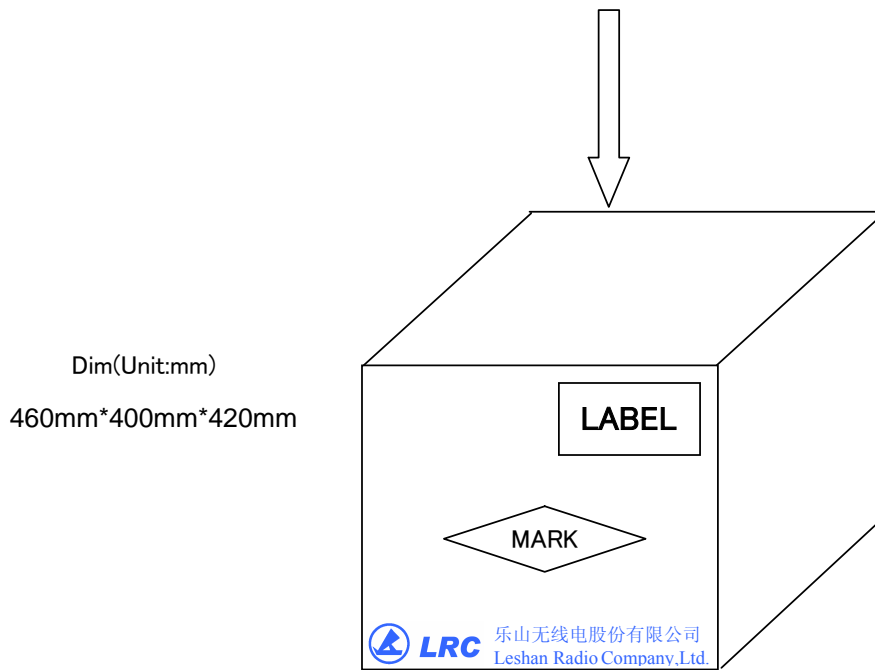
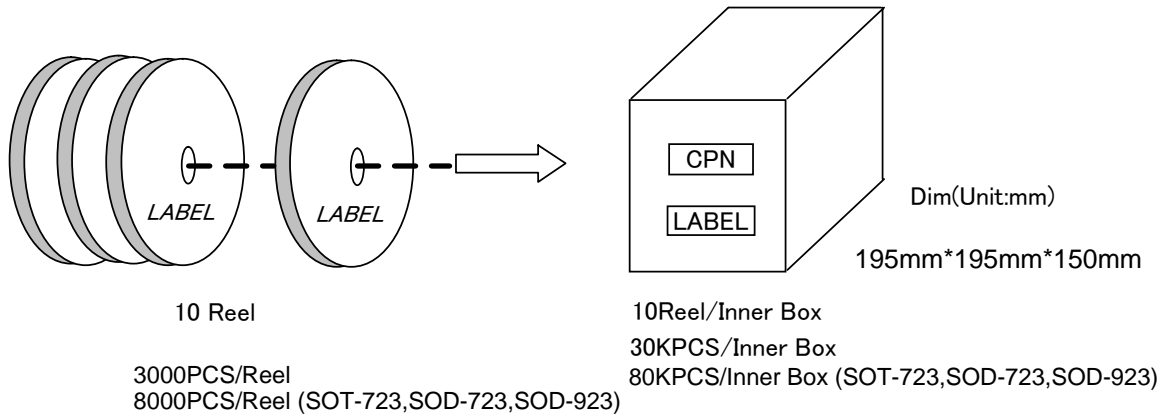

12 Inner Box/Carton

360KPCS/Carton
960KPCS/Carton (SOT-723,SOD-723,SOD-923)