

## High temperature 8 A Snubberless™ Triacs

Datasheet - production data

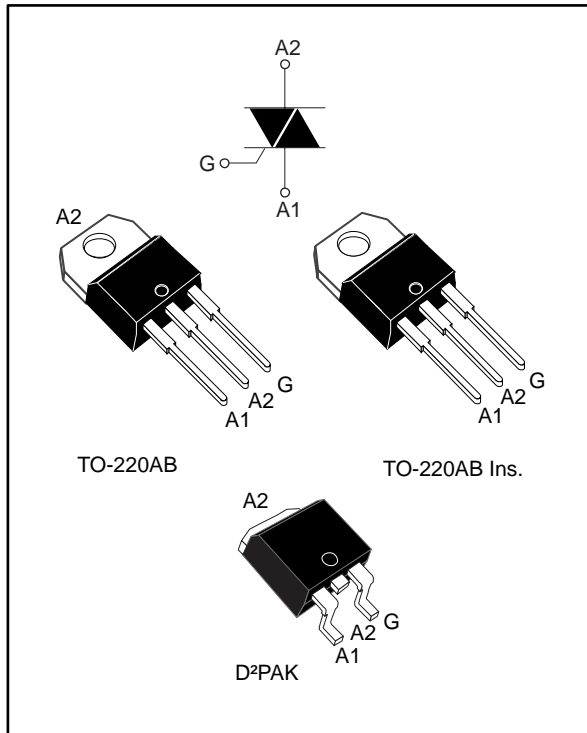

### Applications

Especially designed to operate in high power density or universal motor applications such as vacuum cleaner and washing machine drum motor, these 8 A Triacs provide a very high switching capability up to 150 °C junction temperatures.

The heatsink can be reduced, compared to traditional Triac, according to the high performance at given junction temperatures.

### Description

Available in through-hole or surface mount packages, these Triacs series are suitable for general purpose mains power ac switching.

By using an internal ceramic pad, they provide voltage insulation (rated at 2500 V<sub>RMS</sub>).

Table 1: Device summary

Symbol	Value	Unit
I <sub>T(RMS)</sub>	8	A
V <sub>DRM</sub> /V <sub>RRM</sub>	600	V
I <sub>GT</sub>	35 or 50	mA

### Features

- Medium current Triac
- 150 °C max. T<sub>j</sub> turn-off commutation
- Low thermal resistance with clip bonding
- Very high 3 quadrant commutation capability
- Packages are RoHS (2002/95/EC) compliant
- UL certified (ref. file E81734)

# 1 Characteristics

**Table 2: Absolute ratings (limiting values)**

Symbol	Parameter		Value	Unit	
$I_{T(RMS)}$	RMS on-state current (full sine wave)	D <sup>2</sup> PAK, TO-220AB	$T_C = 133\text{ °C}$	8	A
		TO-220A Ins.	$T_C = 116\text{ °C}$		
$I_{TSM}$	Non repetitive surge peak on-state current (full cycle, $T_j$ initial = 25 °C)	f = 50 Hz	$t_p = 20\text{ ms}$	80	A
		f = 60 Hz	$t_p = 16.7\text{ ms}$	84	
$I^2t$	$I^2t$ value for fusing		$t_p = 10\text{ ms}$	42	A <sup>2</sup> s
dl/dt	Critical rate of rise of on-state current $I_G = 2 \times I_{GT}$ , $t_r \leq 100\text{ ns}$	f = 50 Hz	$T_j = 150\text{ °C}$	50	A/ $\mu$ s
$V_{DSM} / V_{RSM}$	Non repetitive surge peak off-state voltage	$t_p = 10\text{ ms}$	$T_j = 25\text{ °C}$	$V_{DRM}/V_{RRM} + 100$	V
$I_{GM}$	Peak forward gate current	$t_p = 20\text{ }\mu$ s	$T_j = 150\text{ °C}$	4	A
$P_{G(AV)}$	Average gate power dissipation		$T_j = 150\text{ °C}$	1	W
$T_{stg}$	Storage junction temperature range			-40 to +150	°C
$T_j$	Operating junction temperature range			-40 to +150	°C

**Table 3: Electrical characteristics ( $T_j = 25\text{ °C}$  unless otherwise specified)**

Symbol	Test Conditions	Quadrant		Value		Unit
				T835H	T850H	
$I_{GT}^{(1)}$	$V_D = 12\text{ V}$ , $R_L = 33\text{ }\Omega$	I - II - III	Max.	35	50	mA
$V_{GT}$				1.0		
$V_{GD}$	$V_D = V_{DRM}$ , $R_L = 3.3\text{ k}\Omega$	I - II - III	Min.	0.15		V
$I_H^{(2)}$	$I_T = 500\text{ mA}$		Max.	35	75	mA
$I_L$	$I_G = 1.2 \times I_{GT}$	I - III	Max.	50	60	
		II		80	110	
$dV/dt^{(2)}$	$V_D = 2/3 \times V_{DRM}$ , gate open	$T_j = 150\text{ °C}$	Min.	1000	1500	V/ $\mu$ s
$(dl/dt)_c^{(2)}$	Without snubber	$T_j = 150\text{ °C}$	Min.	11	14	A/ms

**Notes:**

<sup>(1)</sup>minimum  $I_{GT}$  is guaranteed at 20% of  $I_{GT}$  max.

<sup>(2)</sup>for both polarities of A2 referenced to A1.

Table 4: Static characteristics

Symbol	Test conditions			Value	Unit
$V_T^{(1)}$	$I_{TM} = 11 \text{ A}$ , $t_p = 380 \mu\text{s}$	$T_j = 25 \text{ }^\circ\text{C}$	Max.	1.5	V
$V_{T0}^{(1)}$	Threshold voltage	$T_j = 150 \text{ }^\circ\text{C}$	Max.	0.80	V
$R_d^{(1)}$	Dynamic resistance	$T_j = 150 \text{ }^\circ\text{C}$	Max.	52	m $\Omega$
$I_{DRM} / I_{RRM}$	$V_{DRM} = V_{RRM}$	$T_j = 25 \text{ }^\circ\text{C}$	Max.	5	$\mu\text{A}$
		$T_j = 150 \text{ }^\circ\text{C}$	Max.	3.1	mA
	$V_D/V_R = 400 \text{ V}$ (at peak mains voltage)	$T_j = 150 \text{ }^\circ\text{C}$	Max.	2.5	
	$V_D/V_R = 200 \text{ V}$ (at peak mains voltage)	$T_j = 150 \text{ }^\circ\text{C}$	Max.	2.0	

**Notes:**<sup>(1)</sup>for both polarities of A2 referenced to A1

Table 5: Thermal parameters

Symbol	Parameter		Value	Unit
$R_{th(j-c)}$	Junction to case (AC)	D <sup>2</sup> PAK, TO-220AB	1.85	$^\circ\text{C/W}$
		TO-220AB Ins.	3.7	
$R_{th(j-a)}$	Junction to ambient ( $S_{cu} = 1 \text{ cm}^2$ , D <sup>2</sup> PAK)	D <sup>2</sup> PAK	45	
	Junction to ambient	TO-220AB, TO-220AB Ins.	60	

# 1.1 Characteristics (curves)

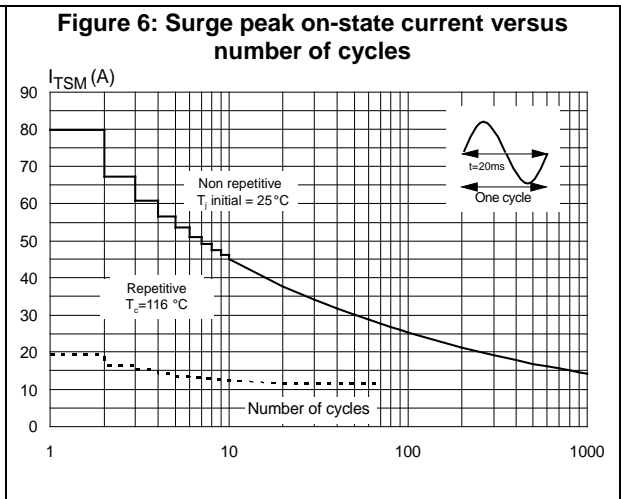
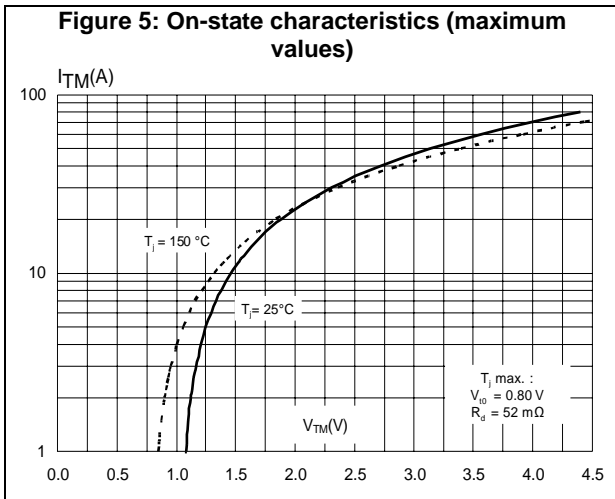
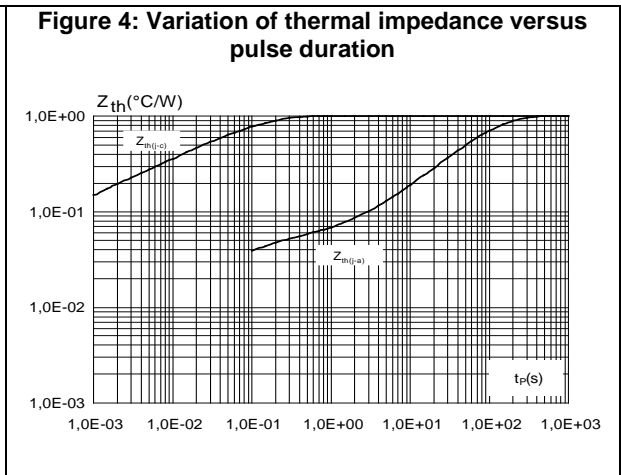
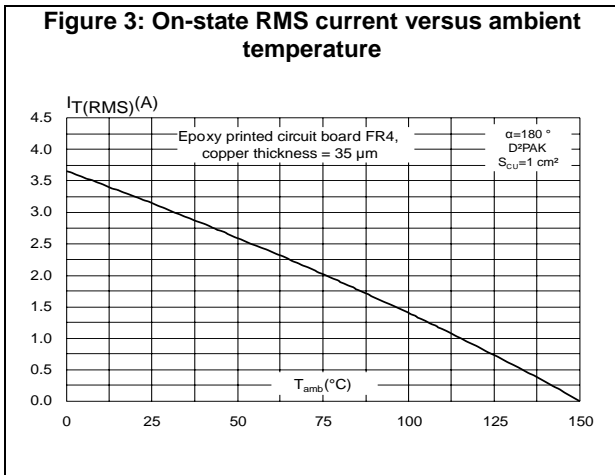
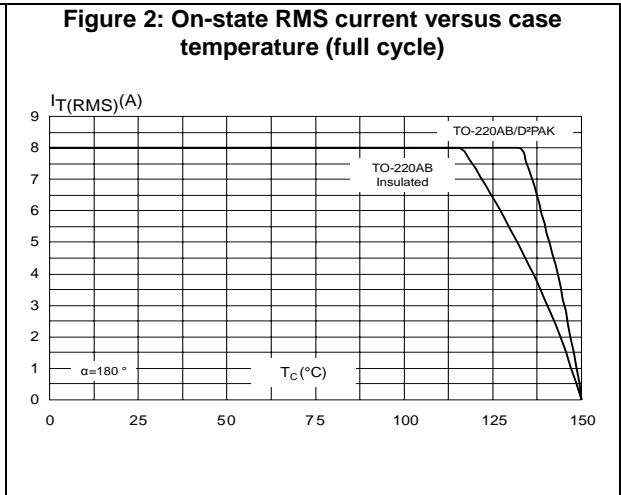
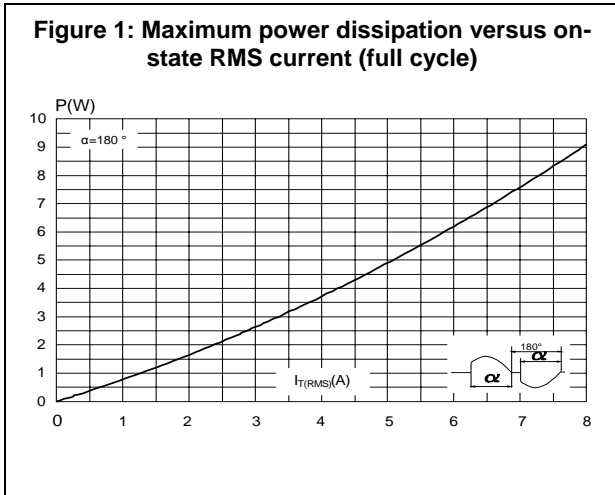

**Figure 7: Non-repetitive surge peak on-state current for a sinusoidal pulse**

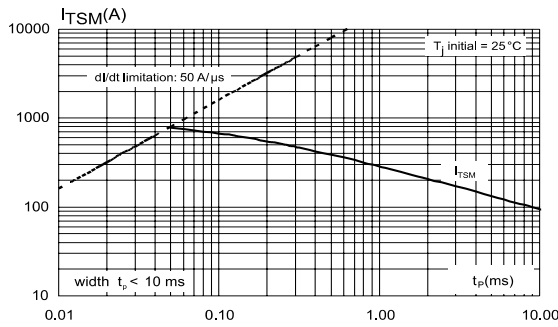

**Figure 8: Relative variation of  $I_{GT}, I_H, I_L$  vs junction temperature (typical values)**

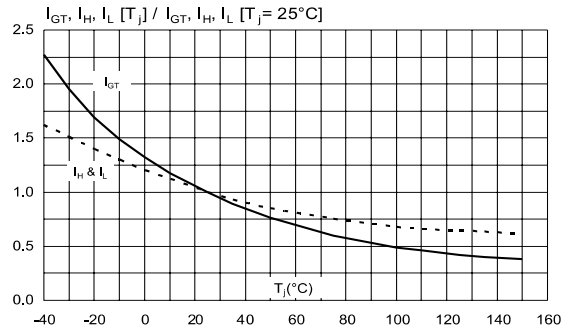

**Figure 9: Relative variation of critical rate of decrease of main current ( $dl/dt$ )c versus reapplied  $(dV/dt)c$**

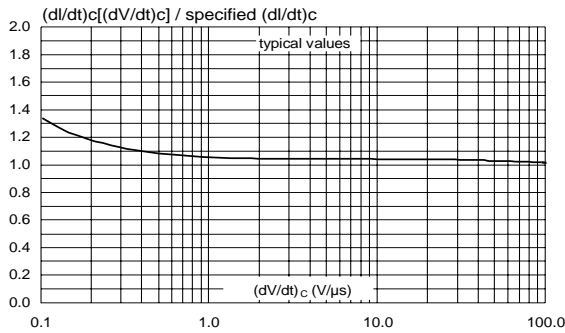

**Figure 10: Relative variation of critical rate of decrease of main current versus junction temperature**

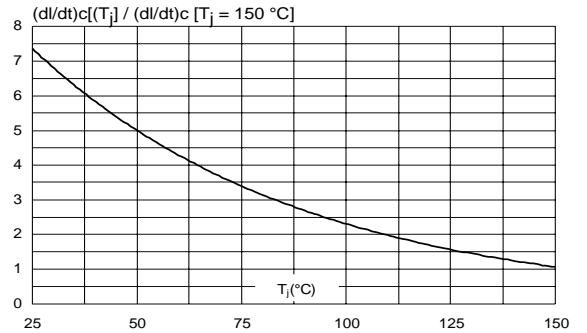

**Figure 11: Leakage current versus junction temperature for different values of blocking voltage (typical values)**

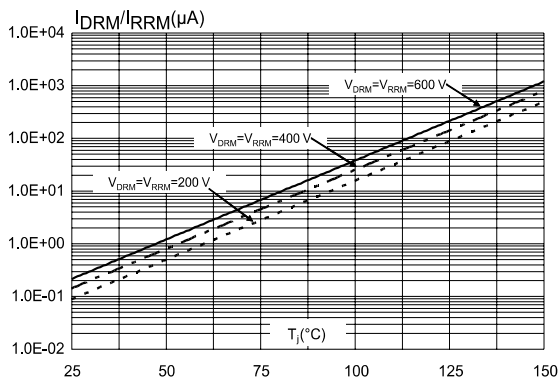

**Figure 12: Variation of thermal resistance junction to ambient versus copper surface under tab**

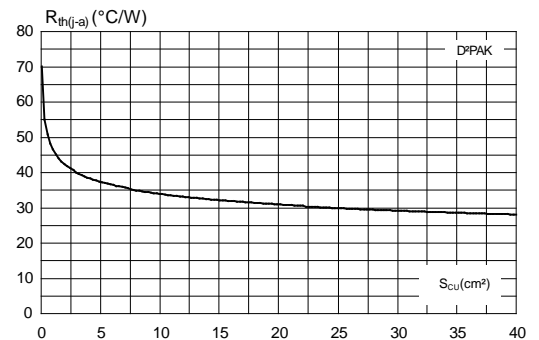

## 2 Package information

In order to meet environmental requirements, ST offers these devices in different grades of ECOPACK® packages, depending on their level of environmental compliance. ECOPACK® specifications, grade definitions and product status are available at: [www.st.com](http://www.st.com). ECOPACK® is an ST trademark.

- Epoxy meets UL94, V0
- Lead-free package leads
- Cooling method: by conduction (C)

### 2.1 D<sup>2</sup>PAK package information

Figure 13: D<sup>2</sup>PAK package outline

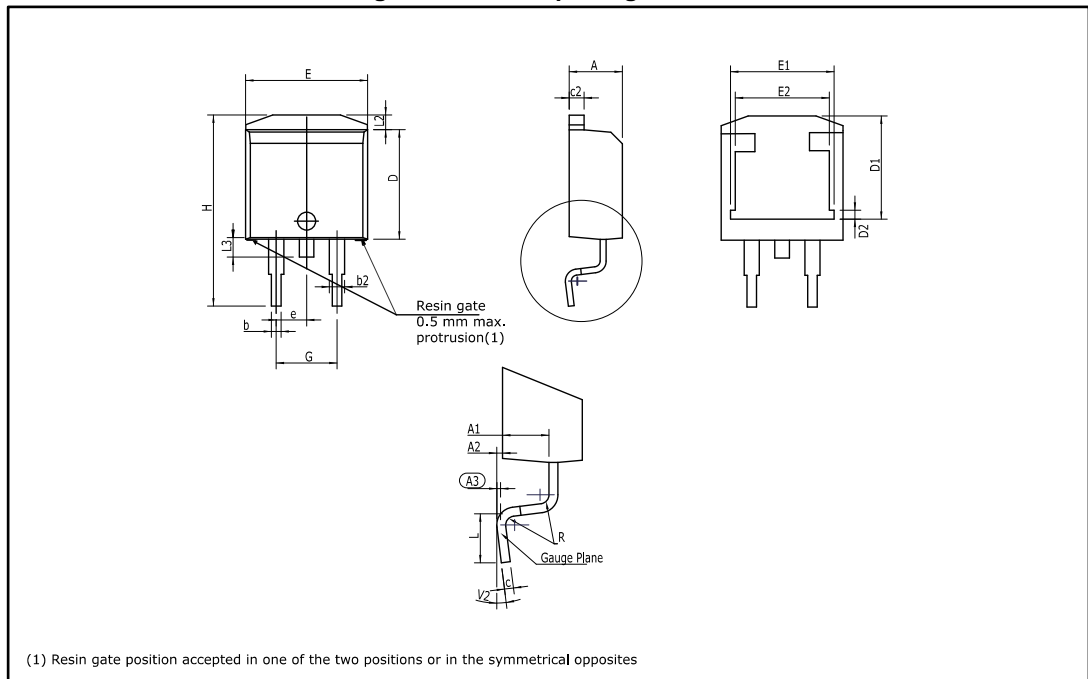
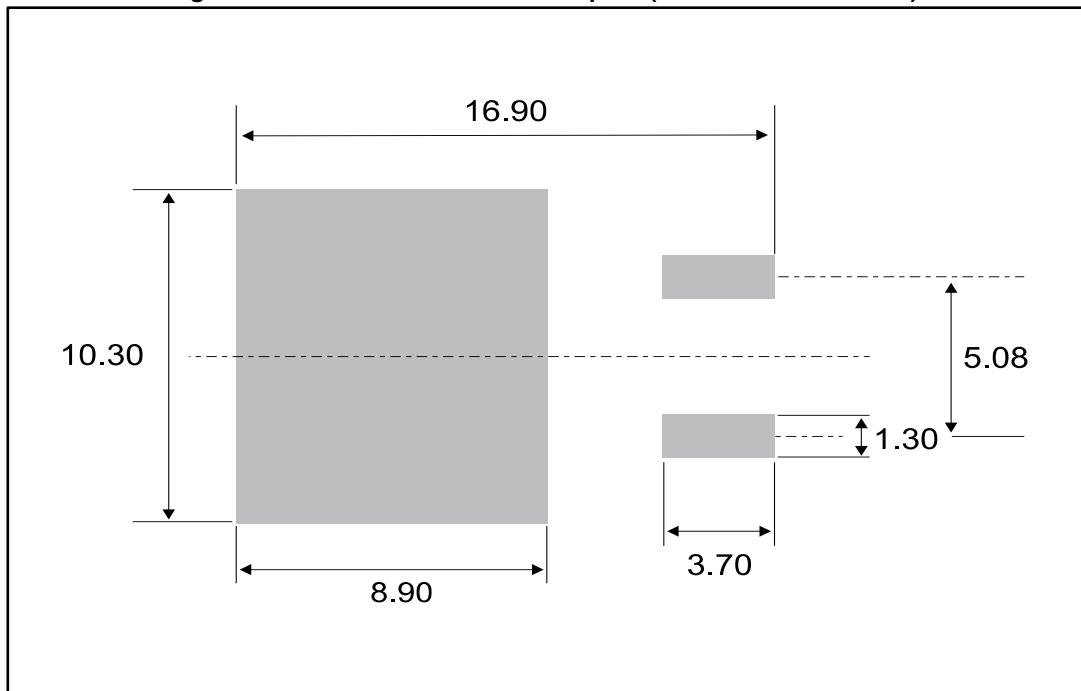

Table 6: D<sup>2</sup>PAK package mechanical data

Ref.	Dimensions					
	Millimeters			Inches <sup>(1)</sup>		
	Min.	Typ.	Max.	Min.	Typ.	Max.
A	4.30		4.60	0.1693		0.1811
A1	2.49		2.69	0.0980		0.1059
A2	0.03		0.23	0.0012		0.0091
A3		0.25			0.0098	
b	0.70		0.93	0.0276		0.0366
b2	1.25		1.7	0.0492		0.0669
c	0.45		0.60	0.0177		0.0236
c2	1.21		1.36	0.0476		0.0535
D	8.95		9.35	0.3524		0.3681
D1	7.50		8.00	0.2953		0.3150
D2	1.30		1.70	0.0512		0.0669
e	2.54			0.1		
E	10.00		10.28	0.3937		0.4047
E1	8.30		8.70	0.3268		0.3425
E2	6.85		7.25	0.2697		0.2854
G	4.88		5.28	0.1921		0.2079
H	15		15.85	0.5906		0.6240
L	1.78		2.28	0.0701		0.0898
L2	1.27		1.40	0.0500		0.0551
L3	1.40		1.75	0.0551		0.0689
R		0.40			0.0157	
V2	0°		8°	0°		8°

**Notes:**<sup>(1)</sup>Dimensions in inches are given for reference only

Figure 14: D<sup>2</sup>PAK recommended footprint (dimensions are in mm)





## 2.2 TO-220AB Insulated package information

Figure 15: TO-220AB Insulated package outline

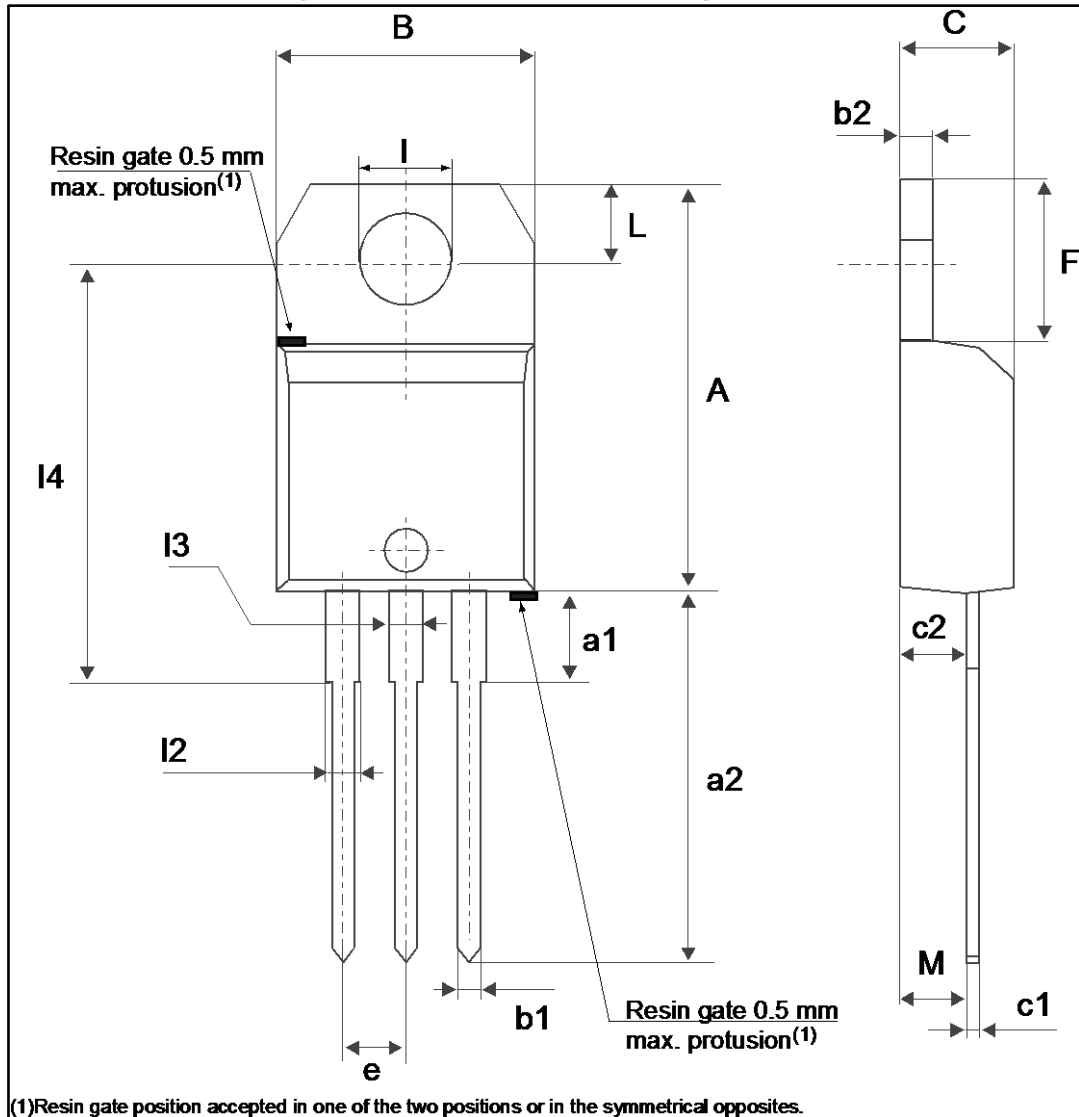

Table 7: TO-220AB Insulated package mechanical data

Ref.	Dimensions					
	Millimeters			Inches <sup>(1)</sup>		
	Min.	Typ.	Max.	Min.	Typ.	Max.
A	15.20		15.90	0.5984		0.6260
a1		3.75			0.1476	
a2	13.00		14.00	0.5118		0.5512
B	10.00		10.40	0.3937		0.4094
b1	0.61		0.88	0.0240		0.0346
b2	1.23		1.32	0.0484		0.0520
C	4.40		4.60	0.1732		0.1811
c1	0.49		0.70	0.0193		0.0276
c2	2.40		2.72	0.0945		0.1071
e	2.40		2.70	0.0945		0.1063
F	6.20		6.60	0.2441		0.2598
I	3.73		3.88	0.1469		0.1528
L	2.65		2.95	0.1043		0.1161
I2	1.14		1.70	0.0449		0.0669
I3	1.14		1.70	0.0449		0.0669
I4	15.80	16.40	16.80	0.6220	0.6457	0.6614
M		2.6			0.1024	

**Notes:**

<sup>(1)</sup>Inch dimensions are for reference only.

### 3 Ordering information

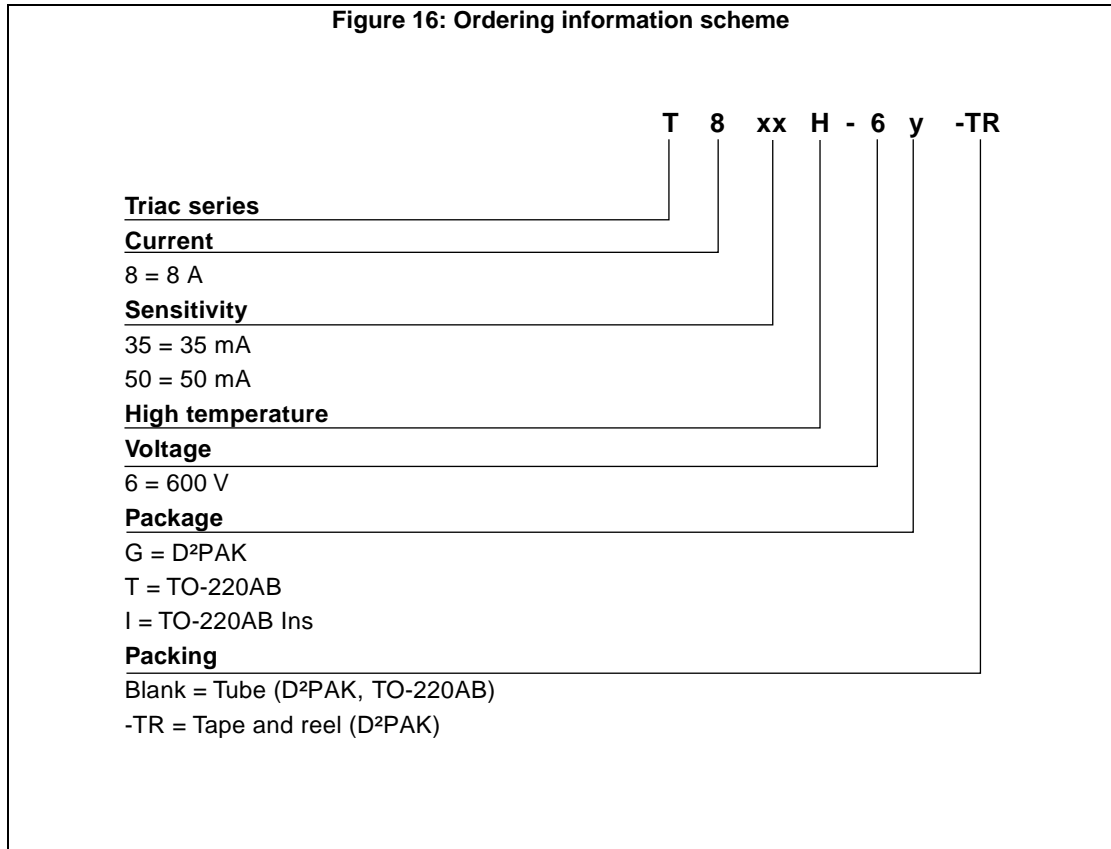

**Table 8: Ordering information**

Order code	Marking	Package	Weight	Base qty.	Delivery mode
T8xxH-6G	T8xxH 6G	D <sup>2</sup> PAK	1.5 g	50	Tube
T8xxH-6G-TR	T8xxH 6G	D <sup>2</sup> PAK	1.5 g	1000	Tape and reel
T8xxH-6T	T8xxH 6T	TO-220AB	2.3 g	50	Tube
T8xxH-6I	T8xxH 6I	TO-220AB Ins.	2.3 g	50	Tube

## 4 Revision history

**Table 9: Document revision history**

Date	Revision	Changes
17-Apr-2007	1	First issue.
19-Sep-2011	2	Updated: <i>Features, Description, Figure 2, Table 2 and 4.</i>
30-Mar-2017	3	Minor text changes. Updated <i>Table 4: "Static characteristics"</i> and <i>Figure 7: "Non-repetitive surge peak on-state current for a sinusoidal pulse"</i> .
07-Feb-2018	4	Updated <i>Table 2: "Absolute ratings (limiting values)"</i> , <i>Figure 2: "On-state RMS current versus case temperature (full cycle)"</i> and <i>Figure 6: "Surge peak on-state current versus number of cycles"</i> .

**IMPORTANT NOTICE – PLEASE READ CAREFULLY**

STMicroelectronics NV and its subsidiaries ("ST") reserve the right to make changes, corrections, enhancements, modifications, and improvements to ST products and/or to this document at any time without notice. Purchasers should obtain the latest relevant information on ST products before placing orders. ST products are sold pursuant to ST's terms and conditions of sale in place at the time of order acknowledgement.

Purchasers are solely responsible for the choice, selection, and use of ST products and ST assumes no liability for application assistance or the design of Purchasers' products.

No license, express or implied, to any intellectual property right is granted by ST herein.

Resale of ST products with provisions different from the information set forth herein shall void any warranty granted by ST for such product.

ST and the ST logo are trademarks of ST. All other product or service names are the property of their respective owners.

Information in this document supersedes and replaces information previously supplied in any prior versions of this document.

© 2018 STMicroelectronics – All rights reserved

# Mouser Electronics

Authorized Distributor

Click to View Pricing, Inventory, Delivery & Lifecycle Information:

[STMicroelectronics:](#)

[T835H-6G](#) [T850H-6G](#) [T850H-6G-TR](#) [T850H-6T](#) [T835H-6I](#) [T835H-6T](#) [T850H-6I](#) [T835H-6G-TR](#)