

## OUTLINE

The R1524x is an ultra-low supply current voltage regulator featuring 200 mA output current and 36 V input voltage. This device consists of an Output Short-circuit Protection Circuit, an Over-current Protection Circuit, and a Thermal Shutdown Circuit in addition to the basic regulator circuits. The operating temperature range is between  $-40^{\circ}\text{C}$  to  $125^{\circ}\text{C}$ , and the maximum input voltage is 36 V. All these features allow this device to become an ideal power source for car accessories and ECUs.

The output voltages are internally fixed (refer to *SELECTION GUIDE*). The output voltage accuracy is  $\pm 0.6\%$ . The packages for this device range from high-density mounting to ultra high wattage. The R1524x is offered in four packages; a 5-pin SOT-23-5, a 5-pin SOT-89-5, and a 6-pin HSOP-6J, and an 8-pin HSOP-8E package.

## FEATURES

- Input Voltage Range (Maximum Rating) ..... 3.5 V to 36 V (50 V)
- Operating Temperature Range .....  $-40^{\circ}\text{C}$  to  $125^{\circ}\text{C}$
- Supply Current ..... Typ. 2.2  $\mu\text{A}$
- Standby Current ..... Typ. 0.1  $\mu\text{A}$
- Dropout Voltage ..... Typ. 0.6 V ( $I_{\text{OUT}} = 200 \text{ mA}$ ,  $V_{\text{OUT}} = 5.0 \text{ V}$ )
- Output Voltage Range ..... 1.8 V / 2.5 V / 2.8 V / 3.0 V / 3.3 V / 3.4 V / 5.0 V / 5.5 V /  
6.0 V / 6.4 V / 7.0 V / 7.5 V / 8.0 V / 8.5 V / 9.0 V /  
10.0 V / 10.5 V / 11.0 V / 12.0 V  
\*Contact Ricoh sales representatives for other voltages.
- Output Voltage Accuracy .....  $\pm 0.6\%$  ( $T_a = 25^{\circ}\text{C}$ )
- Output Voltage Temperature-Drift Coefficient ..... Typ.  $\pm 60 \text{ ppm}/^{\circ}\text{C}$
- Line Regulation ..... Typ. 0.01%/V ( $V_{\text{SET}} + 1 \text{ V} \leq V_{\text{IN}} \leq 36 \text{ V}$ )
- Built-in Output Short-circuit Protection Circuit ..... Typ. 80 mA
- Built-in Over-current Protection Circuit ..... Typ. 350 mA
- Built-in Thermal Shutdown Circuit ..... Thermal Shutdown Temperature: Typ.  $160^{\circ}\text{C}$
- Ceramic capacitors are recommended  
to be used with this device .....  $C_{\text{OUT}} = 0.1 \mu\text{F}$  or more
- Packages ..... SOT-23-5, SOT-89-5, HSOP-6J, HSOP-8E

## APPLICATIONS

- Power source for accessories such as car audios, car navigation systems, and ETC systems
- Power source for ECUs such as EV inverter and battery charge control unit

---

**R1524x**

---

EC-332-200602

---

**SELECTION GUIDE**

The set output voltage, the package type, and the quality class are user-selectable.

**Selection Guide**

Product Name	Package	Quantity per Reel	Pb Free	Halogen Free
R1524NxxxB-TR-#E	SOT-23-5	3,000 pcs	Yes	Yes
R1524HxxxB-T1-#E	SOT-89-5	1,000 pcs	Yes	Yes
R1524SxxxB-E2-#E	HSOP-6J	1,000 pcs	Yes	Yes
R1524SxxxH-E2-#E	HSOP-8E	1,000 pcs	Yes	Yes

xxx: Specify the set output voltage ( $V_{SET}$ )

1.8 V (018) / 2.5 V (025) / 2.8 V (028) / 3.0 V (030) / 3.3 V (033) / 3.4 V (034) / 5.0 V (050) /  
5.5 V (055) / 6.0 V (060) / 6.4 V (064) / 7.0 V (070) / 7.5 V (075) / 8.0 V (080) / 8.5 V (085) /  
9.0 V (090) / 10.0 V (100) / 10.5 V (105) / 11.0 V (110) / 12.0 V (120)

\*Contact Ricoh sales representatives for other voltages.

# : Quality Class

#	Operating Temperature Range	Test Temperature
A	-40°C to 125°C	25°C, High
K	-40°C to 125°C	Low, 25°C, High

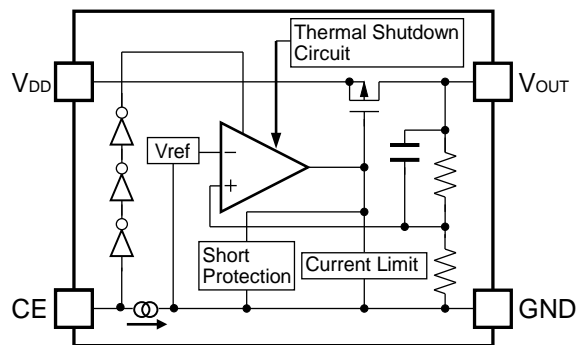
**BLOCK DIAGRAM**

R1524x Block Diagram

## PIN DESCRIPTIONS

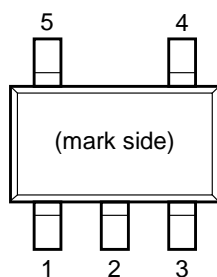

**SOT-23-5 Pin Configuration**

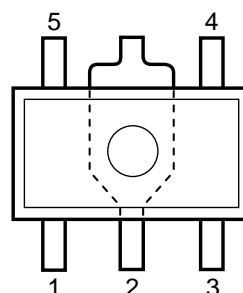

**SOT-89-5 Pin Configuration**

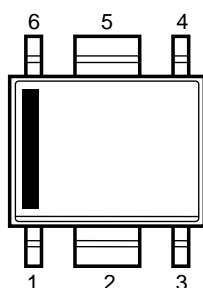

**HSOP-6J Pin Configuration**

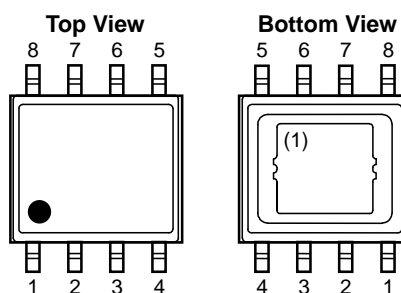

**HSOP-8E Pin Configuration**

### SOT-23-5 Pin Descriptions

Pin No.	Symbol	Description
1	GND <sup>(2)</sup>	Ground Pin
2	GND <sup>(2)</sup>	Ground Pin
3	CE	Chip Enable Pin (Active-high)
4	V <sub>OUT</sub>	Output Pin
5	V <sub>DD</sub>	Input Pin

### SOT-89-5 Pin Descriptions

Pin No.	Symbol	Description
1	V <sub>OUT</sub>	Output Pin
2	GND <sup>(2)</sup>	Ground Pin
3	CE	Chip Enable Pin (Active-high)
4	GND <sup>(2)</sup>	Ground Pin
5	V <sub>DD</sub>	Input Pin

<sup>(1)</sup> The tab on the bottom of the package enhances thermal performance and is electrically connected to GND (substrate level). It is recommended that the tab be connected to the ground plane on the board, or otherwise be left open.

<sup>(2)</sup> The GND pin must be wired together when it is mounted on board.

## R1524x

EC-332-200602

### HSOP-6J Pin Descriptions

Pin No.	Symbol	Description
1	$V_{OUT}$	Output Pin
2	GND <sup>(1)</sup>	Ground Pin
3	CE	Chip Enable Pin (Active-high)
4	GND <sup>(1)</sup>	Ground Pin
5	GND <sup>(1)</sup>	Ground Pin
6	$V_{DD}$	Input Pin

### HSOP-8E Pin Descriptions

Pin No.	Symbol	Description
1	$V_{OUT}$	Output Pin
2	NC	No Connection
3	NC	No Connection
4	CE	Chip Enable Pin (Active-high)
5	GND	Ground Pin
6	NC	No Connection
7	NC	No Connection
8	$V_{DD}$	Input Pin

### PIN EQUIVALENT CIRCUIT DIAGRAMS

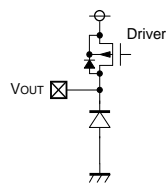

**$V_{OUT}$  Pin**

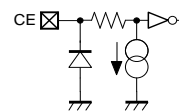

**CE Pin**

<sup>(1)</sup> The GND pin must be wired together when it is mounted on board.

## ABSOLUTE MAXIMUM RATINGS

### Absolute Maximum Ratings

Symbol	Item	Rating	Unit	
V <sub>IN</sub>	Input Voltage	-0.3 to 50	V	
V <sub>IN</sub>	Peak Input Voltage <sup>(1)</sup>	60	V	
V <sub>CE</sub>	Input Voltage (CE Pin)	-0.3 to 50	V	
V <sub>OUT</sub>	Output Voltage	-0.3 to V <sub>IN</sub> + 0.3 ≤ 50	V	
I <sub>OUT</sub>	Output Current	300	mA	
P <sub>D</sub>	Power Dissipation <sup>(2)</sup> (JEDEC STD.51-7 Test Land Pattern)	SOT-23-5	830	mW
		SOT-89-5	3200	
		HSOP-6J	3400	
		HSOP-8E	3600	
T <sub>j</sub>	Junction Temperature Range	-40 to 150	°C	
T <sub>stg</sub>	Storage Temperature Range	-55 to 150	°C	

### ABSOLUTE MAXIMUM RATINGS

Electronic and mechanical stress momentarily exceeded absolute maximum ratings may cause permanent damage and may degrade the lifetime and safety for both device and system using the device in the field. The functional operation at or over these absolute maximum ratings are not assured.

## RECOMMENDED OPERATING CONDITIONS

### Recommended Operating Conditions

Symbol	Item	Rating	Unit
V <sub>IN</sub>	Input Voltage	3.5 to 36	V
T <sub>a</sub>	Operating Temperature Range	-40 to 125	°C

### RECOMMENDED OPERATING CONDITIONS

All of electronic equipment should be designed that the mounted semiconductor devices operate within the recommended operating conditions. The semiconductor devices cannot operate normally over the recommended operating conditions, even if they are used over such conditions by momentary electronic noise or surge. And the semiconductor devices may receive serious damage when they continue to operate over the recommended operating conditions.

<sup>(1)</sup> Duration time: 200 ms

<sup>(2)</sup> Refer to *POWER DISSIPATION* for detailed information.

## ELECTRICAL CHARACTERISTICS

$C_{IN} = C_{OUT} = 0.1 \mu\text{F}$ , unless otherwise noted.

The specifications surrounded by  $\square$  are guaranteed by design engineering at  $-40^\circ\text{C} \leq T_a \leq 125^\circ\text{C}$ .

## R1524x (-AE) Electrical Characteristics

(Ta = 25°C)

Symbol	Item	Conditions	Min.	Typ.	Max.	Unit	
I <sub>SS</sub>	Supply Current	V <sub>IN</sub> = 14 V I <sub>OUT</sub> = 0 mA	V <sub>SET</sub> ≤ 5.0 V		2.2	$\square$ 6.5	μA
			5.0 V < V <sub>SET</sub>		2.5	$\square$ 6.8	
I <sub>standby</sub>	Standby Current	V <sub>IN</sub> = 36 V, V <sub>CE</sub> = 0 V		0.1	1.0	μA	
V <sub>OUT</sub>	Output Voltage	V <sub>SET</sub> + 1 V <sup>(1)</sup> ≤ V <sub>IN</sub> ≤ 36 V, I <sub>OUT</sub> = 1 mA	Ta = 25°C	×0.994		×1.006	V
			-40°C ≤ Ta ≤ 125°C	$\square$ 0.984		$\square$ 1.016	
$\frac{\Delta V_{OUT}}{\Delta I_{OUT}}$	Load Regulation	V <sub>IN</sub> = V <sub>SET</sub> + 3.0 V 1 mA ≤ I <sub>OUT</sub> ≤ 200 mA	Refer to the <i>Product-specific Electrical Characteristics</i>				
$\frac{\Delta V_{OUT}}{\Delta V_{IN}}$	Line Regulation	V <sub>SET</sub> + 1 V <sup>(1)</sup> ≤ V <sub>IN</sub> ≤ 36 V, I <sub>OUT</sub> = 1 mA	V <sub>SET</sub> < 3.3 V	$\square$ -20	5	$\square$ 20	mV
			3.3 V ≤ V <sub>SET</sub>	$\square$ -0.02	0.01	$\square$ 0.02	%/V
V <sub>DIF</sub>	Dropout Voltage	I <sub>OUT</sub> = 200 mA	Refer to the <i>Product-specific Electrical Characteristics</i>				
I <sub>LIM</sub>	Output Current Limit	V <sub>IN</sub> = V <sub>SET</sub> + 3.0 V	$\square$ 220	350	$\square$ 420	mA	
I <sub>SC</sub>	Short Current Limit	V <sub>IN</sub> = 3.5 V, V <sub>OUT</sub> = 0 V	$\square$ 60	80	$\square$ 110	mA	
V <sub>CEH</sub>	CE Pin Input Voltage, high	V <sub>IN</sub> = V <sub>SET</sub> + 1 V <sup>(1)</sup>	$\square$ 2.0		36	V	
V <sub>CEL</sub>	CE Pin Input Voltage, low	V <sub>IN</sub> = 36 V	0		$\square$ 1.0	V	
I <sub>PD</sub>	CE Pull-down Current	V <sub>IN</sub> = 36 V, V <sub>CE</sub> = 2 V		0.2	$\square$ 0.6	μA	
T <sub>TSD</sub>	Thermal Shutdown Detection Temperature	Junction Temperature		160		°C	
T <sub>TSR</sub>	Thermal Shutdown Released Temperature	Junction Temperature		135		°C	

All test items listed under Electrical Characteristics are done under the pulse load condition (T<sub>j</sub> ≈ Ta = 25°C).

<sup>(1)</sup> V<sub>SET</sub> ≤ 2.5 V, V<sub>IN</sub> = 3.5 V

The specifications surrounded by  $\square$  are guaranteed by design engineering at  $-40^{\circ}\text{C} \leq T_a \leq 125^{\circ}\text{C}$ .

**R1524x (-AE) Product-specific Electrical Characteristics**

(Ta = 25°C)

Product Name	V <sub>OUT</sub> (V) (Ta = 25°C)			V <sub>OUT</sub> (V) (-40°C ≤ Ta ≤ 125°C)			ΔV <sub>OUT</sub> /ΔI <sub>OUT</sub> (mV)			V <sub>DIF</sub> (V)				
	MIN.	TYP.	MAX.	MIN.	TYP.	MAX.	MIN.	TYP.	MAX.	TYP.	MAX.			
R1524x018x	1.7892	1.80	1.8108	$\square$ 1.7712	1.80	$\square$ 1.8288	$\square$ -10	10	$\square$ 40	1.6	$\square$ 2.5			
R1524x025x	2.4850	2.50	2.5150	$\square$ 2.4600	2.50	$\square$ 2.5400				1.2	$\square$ 2.2			
R1524x028x	2.7832	2.80	2.8168	$\square$ 2.7552	2.80	$\square$ 2.8448				0.8	$\square$ 2.0			
R1524x030x	2.9820	3.00	3.0180	$\square$ 2.9520	3.00	$\square$ 3.0480				$\square$ -18	18	$\square$ 72	0.6	$\square$ 1.2
R1524x033x	3.2802	3.30	3.3198	$\square$ 3.2472	3.30	$\square$ 3.3528								
R1524x034x	3.3796	3.40	3.4204	$\square$ 3.3456	3.40	$\square$ 3.4544								
R1524x050x	4.9700	5.00	5.0300	$\square$ 4.9200	5.00	$\square$ 5.0800								
R1524x055x	5.4670	5.50	5.5330	$\square$ 5.4120	5.50	$\square$ 5.5880								
R1524x060x	5.9640	6.00	6.0360	$\square$ 5.9040	6.00	$\square$ 6.0960								
R1524x064x	6.3616	6.40	6.4384	$\square$ 6.2976	6.40	$\square$ 6.5024	0.5	$\square$ 1.2						
R1524x070x	6.9580	7.00	7.0420	$\square$ 6.8880	7.00	$\square$ 7.1120								
R1524x075x	7.4550	7.50	7.5450	$\square$ 7.3800	7.50	$\square$ 7.6200								
R1524x080x	7.9520	8.00	8.0480	$\square$ 7.8720	8.00	$\square$ 8.1280								
R1524x085x	8.4490	8.50	8.5510	$\square$ 8.3640	8.50	$\square$ 8.6360								
R1524x090x	8.9460	9.00	9.0540	$\square$ 8.8560	9.00	$\square$ 9.1440								
R1524x100x	9.9400	10.0	10.0600	$\square$ 9.8400	10.0	$\square$ 10.1600	0.5	$\square$ 1.2						
R1524x105x	10.4370	10.5	10.5630	$\square$ 10.3320	10.5	$\square$ 10.6680								
R1524x110x	10.9340	11.0	11.0660	$\square$ 10.8240	11.0	$\square$ 11.1760								
R1524x120x	11.9280	12.0	12.0720	$\square$ 11.8080	12.0	$\square$ 12.1920								

**R1524x**

EC-332-200602

 $C_{IN} = C_{OUT} = 0.1 \mu\text{F}$ , unless otherwise noted.**R1524x (-KE) Electrical Characteristics**( $-40^{\circ}\text{C} \leq T_a \leq 125^{\circ}\text{C}$ )

Symbol	Item	Conditions	Min.	Typ.	Max.	Unit	
$I_{SS}$	Supply Current	$V_{IN} = 14 \text{ V}$ $I_{OUT} = 0 \text{ mA}$	$V_{SET} \leq 5.0 \text{ V}$		2.2	6.5	$\mu\text{A}$
			$5.0 \text{ V} < V_{SET}$		2.5	6.8	
$I_{standby}$	Standby Current	$V_{IN} = 36 \text{ V}$ , $V_{CE} = 0 \text{ V}$		0.1	1.0	$\mu\text{A}$	
$V_{OUT}$	Output Voltage	$V_{SET} + 1 \text{ V}^{(1)} \leq V_{IN} \leq 36 \text{ V}$ , $I_{OUT} = 1 \text{ mA}$	$T_a = 25^{\circ}\text{C}$	$\times 0.994$		$\times 1.006$	V
			$-40^{\circ}\text{C} \leq T_a \leq 125^{\circ}\text{C}$	$\times 0.984$		$\times 1.016$	
$\frac{\Delta V_{OUT}}{\Delta I_{OUT}}$	Load Regulation	$V_{IN} = V_{SET} + 3.0 \text{ V}$ $1 \text{ mA} \leq I_{OUT} \leq 200 \text{ mA}$	Refer to the <i>Product-specific Electrical Characteristics</i>				
$\frac{\Delta V_{OUT}}{\Delta V_{IN}}$	Line Regulation	$V_{SET} + 1 \text{ V}^{(1)} \leq V_{IN} \leq 36 \text{ V}$ , $I_{OUT} = 1 \text{ mA}$	$V_{SET} < 3.3 \text{ V}$	-20	5	20	mV
			$3.3 \text{ V} \leq V_{SET}$	-0.02	0.01	0.02	%/V
$V_{DIF}$	Dropout Voltage	$I_{OUT} = 200 \text{ mA}$	Refer to the <i>Product-specific Electrical Characteristics</i>				
$I_{LIM}$	Output Current Limit	$V_{IN} = V_{SET} + 3.0 \text{ V}$	220	350	420	mA	
$I_{SC}$	Short Current Limit	$V_{IN} = 3.5 \text{ V}$ , $V_{OUT} = 0 \text{ V}$	60	80	110	mA	
$V_{CEH}$	CE Pin Input Voltage, high	$V_{IN} = V_{SET} + 1 \text{ V}^{(1)}$	2.0		36	V	
$V_{CEL}$	CE Pin Input Voltage, low	$V_{IN} = 36 \text{ V}$	0		1.0	V	
$I_{PD}$	CE Pull-down Current	$V_{IN} = 36 \text{ V}$ , $V_{CE} = 2 \text{ V}$		0.2	0.6	$\mu\text{A}$	
$T_{TSD}$	Thermal Shutdown Detection Temperature	Junction Temperature	150	160		$^{\circ}\text{C}$	
$T_{TSR}$	Thermal Shutdown Released Temperature	Junction Temperature	125	135		$^{\circ}\text{C}$	

<sup>(1)</sup>  $V_{SET} \leq 2.5 \text{ V}$ ,  $V_{IN} = 3.5 \text{ V}$



## R1524x (-KE) Product-specific Electrical Characteristics

(-40°C ≤ Ta ≤ 125°C)

Product Name	V <sub>OUT</sub> (V) (Ta = 25°C)			V <sub>OUT</sub> (V) (-40°C ≤ Ta ≤ 125°C)			ΔV <sub>OUT</sub> /ΔI <sub>OUT</sub> (mV)			V <sub>DIF</sub> (V)				
	MIN.	TYP.	MAX.	MIN.	TYP.	MAX.	MIN.	TYP.	MAX.	TYP.	MAX.			
R1524x018x	1.7892	1.80	1.8108	1.7712	1.80	1.8288	-10	10	40	1.6	2.5			
R1524x025x	2.4850	2.50	2.5150	2.4600	2.50	2.5400				-18	18	72	1.2	2.2
R1524x028x	2.7832	2.80	2.8168	2.7552	2.80	2.8448							0.8	2.0
R1524x030x	2.9820	3.00	3.0180	2.9520	3.00	3.0480								
R1524x033x	3.2802	3.30	3.3198	3.2472	3.30	3.3528								
R1524x034x	3.3796	3.40	3.4204	3.3456	3.40	3.4544								
R1524x050x	4.9700	5.00	5.0300	4.9200	5.00	5.0800	-18	18	72	0.6	1.2			
R1524x055x	5.4670	5.50	5.5330	5.4120	5.50	5.5880								
R1524x060x	5.9640	6.00	6.0360	5.9040	6.00	6.0960								
R1524x064x	6.3616	6.40	6.4384	6.2976	6.40	6.5024								
R1524x070x	6.9580	7.00	7.0420	6.8880	7.00	7.1120								
R1524x075x	7.4550	7.50	7.5450	7.3800	7.50	7.6200								
R1524x080x	7.9520	8.00	8.0480	7.8720	8.00	8.1280				0.5				
R1524x085x	8.4490	8.50	8.5510	8.3640	8.50	8.6360								
R1524x090x	8.9460	9.00	9.0540	8.8560	9.00	9.1440								
R1524x100x	9.9400	10.0	10.0600	9.8400	10.0	10.1600								
R1524x105x	10.4370	10.5	10.5630	10.3320	10.5	10.6680								
R1524x110x	10.9340	11.0	11.0660	10.8240	11.0	11.1760								
R1524x120x	11.9280	12.0	12.0720	11.8080	12.0	12.1920								

## THEORY OF OPERATION

### Thermal Shutdown

R1524x has a built-in thermal shutdown circuit, which stops the regulator operation if the junction temperature of this device increases to 160°C (Typ.) or higher. If the temperature drops to 135°C (Typ.) or lower, the regulator restarts the operation. Unless eliminating the overheating problem, the regulator turns on and off repeatedly and as a result, a pulse shaped output voltage is generated.

## APPLICATION INFORMATION

### TYPICAL APPLICATIONS

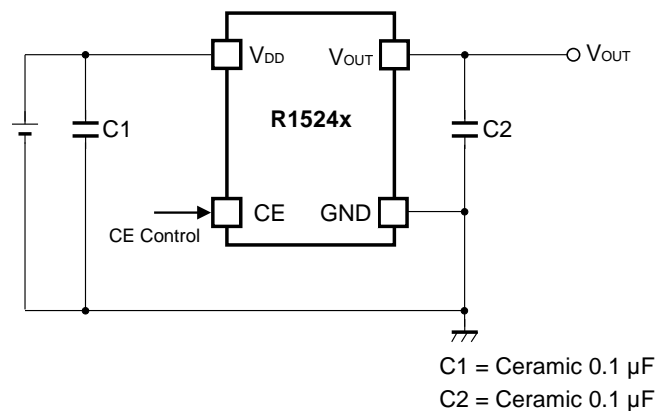

**R1524x Typical Applications**

### TYPICAL APPLICATION FOR IC CHIP BREAKDOWN PREVENTION

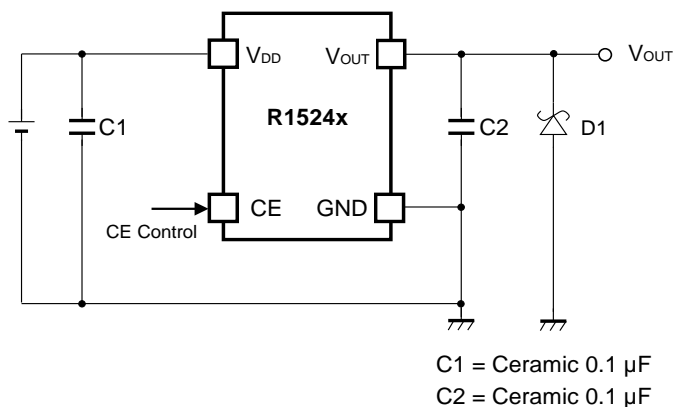

**R1524x Typical Application for IC Chip Breakdown Prevention**

When a sudden surge of electrical current travels along the V<sub>OUT</sub> pin and GND due to a short-circuit, electrical resonance of a circuit involving an output capacitor (C2) and a short circuit inductor generates a negative voltage and may damage the device or the load devices. Connecting a schottky diode (D1) between the V<sub>OUT</sub> pin and GND has the effect of preventing damage to them.

## TECHNICAL NOTES

### Phase Compensation

In the R1524x, phase compensation is provided to secure stable operation even when the load current is varied. For this purpose, make sure to use 0.1  $\mu\text{F}$  or more of a capacitor (C2).

In case of using a tantalum type capacitor and the ESR (Equivalent Series Resistance) value of the capacitor is large, the output might be unstable. Evaluate the circuit including consideration of frequency characteristics. Connect 0.1  $\mu\text{F}$  or more of a capacitor (C1) between  $V_{\text{DD}}$  and GND, and as close as possible to the pins.

### PCB Layout

For SOT-23-5 package type, wire the following GND pins together: No. 1 and No. 2

For SOT-89-5 package type, wire the following GND pins together: No. 2 and No. 4.

For HSOP-6J package type, wire the following GND pins together: No. 2, No. 4, and No. 5.

## TYPICAL CHARACTERISTICS

Note: Typical Characteristics are intended to be used as reference data; they are not guaranteed.

### 1) Output Voltage vs. Output Current (Ta = 25°C)

R1524x018B

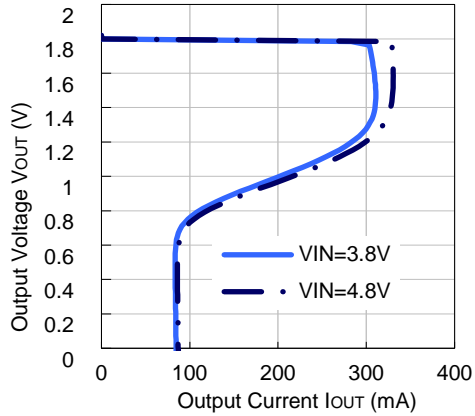

R1524x033B

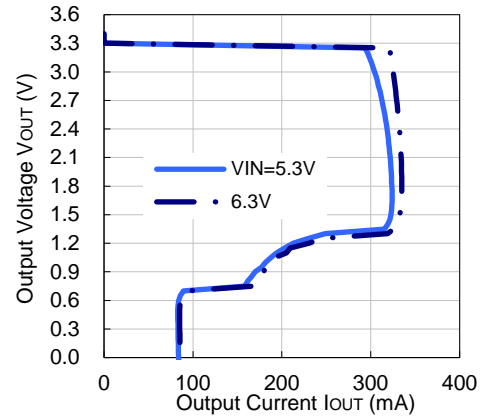

R1524x050B

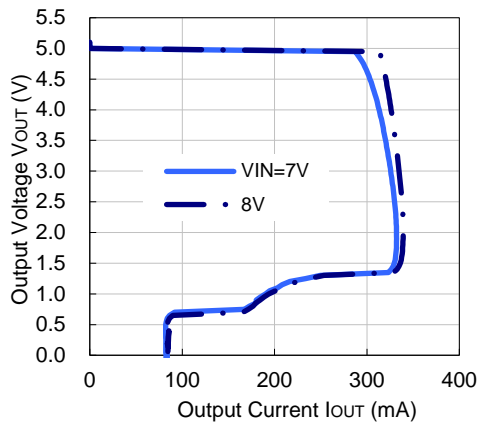

R1524x090B

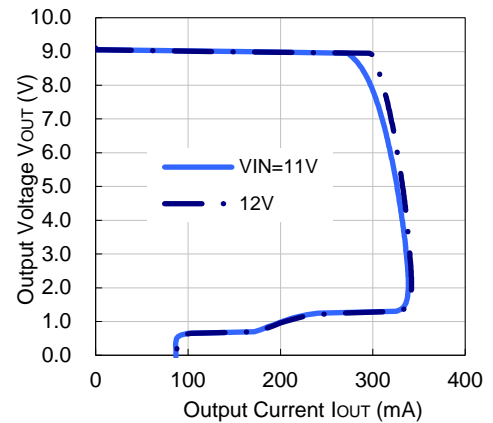

R1524x120B

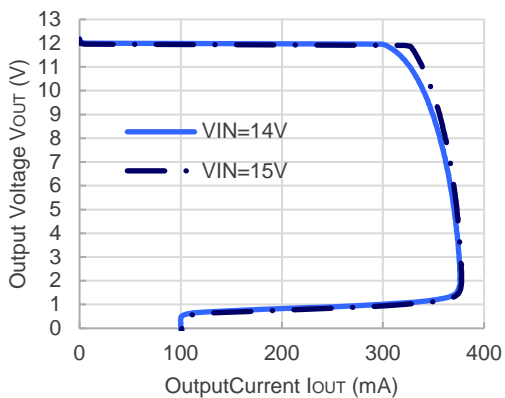

2) Output Voltage vs. Input Voltage (Ta = 25°C)

R1524x018B

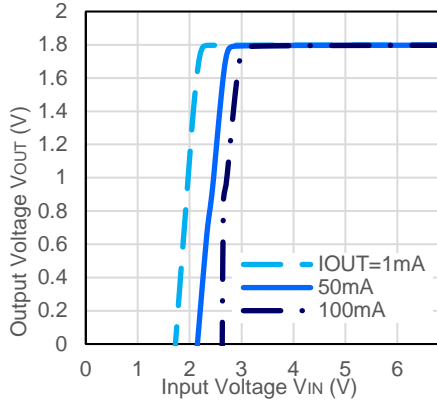

R1524x033B

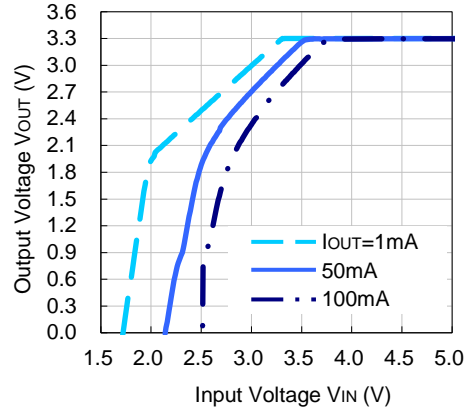

R1524x050B

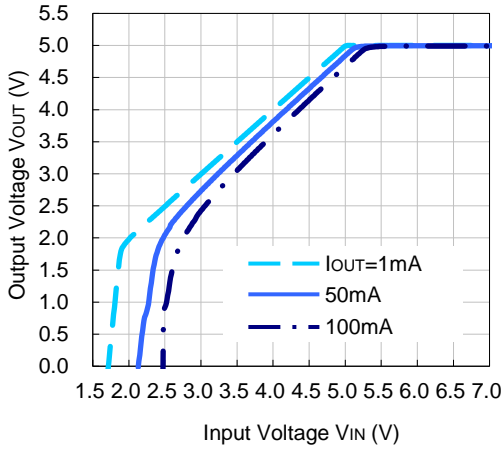

R1524x090B

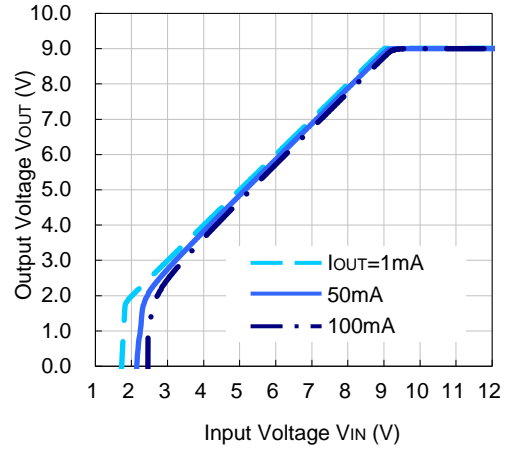

R1524x120B

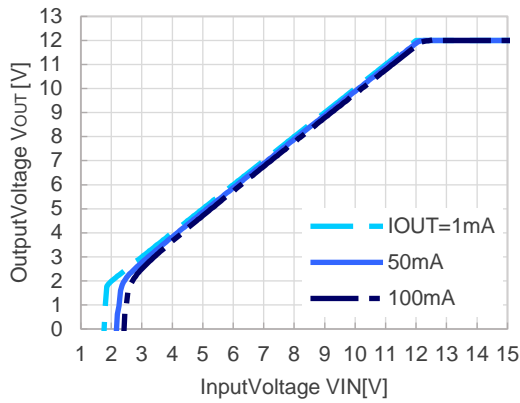

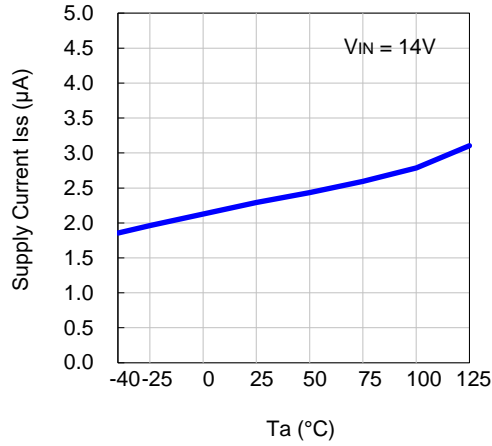
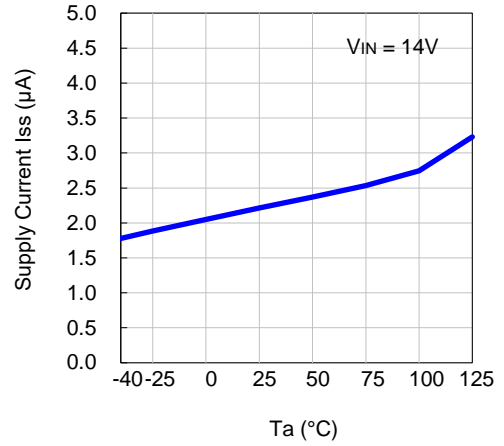
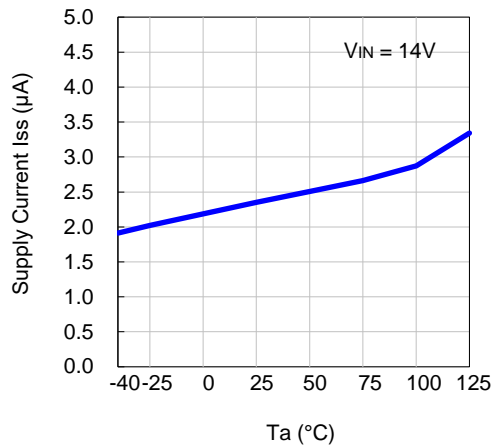
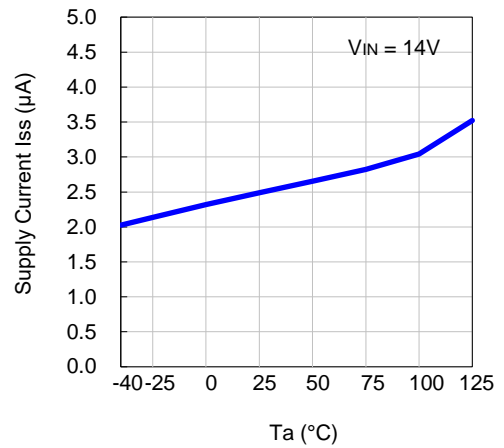
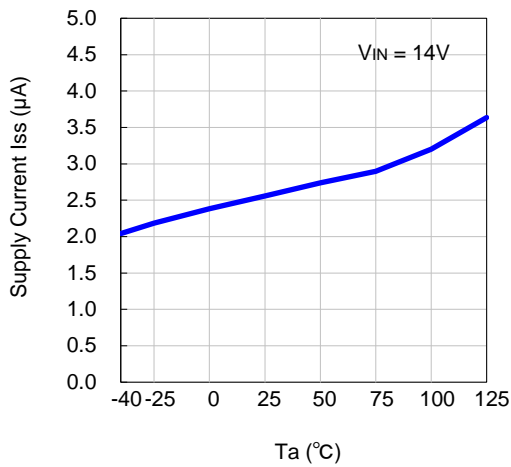
**3) Supply Current vs. Temperature****R1524x018B****R1524x033B****R1524x050B****R1524x090B****R1524x120B**

4) Supply Current vs. Input Voltage

R1524x018B

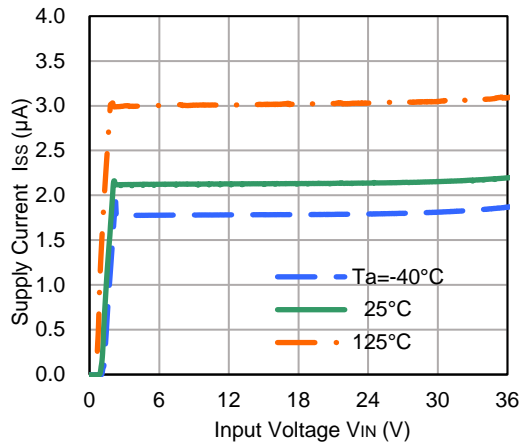

R1524x033B

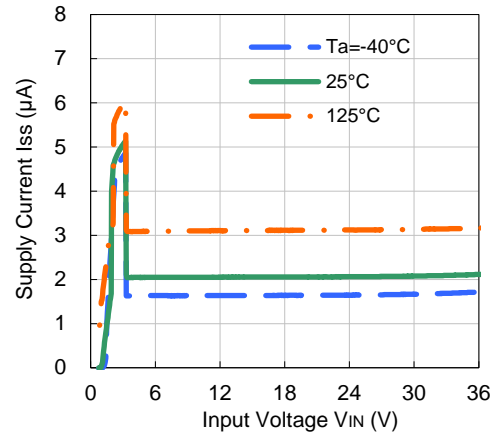

R1524x120B

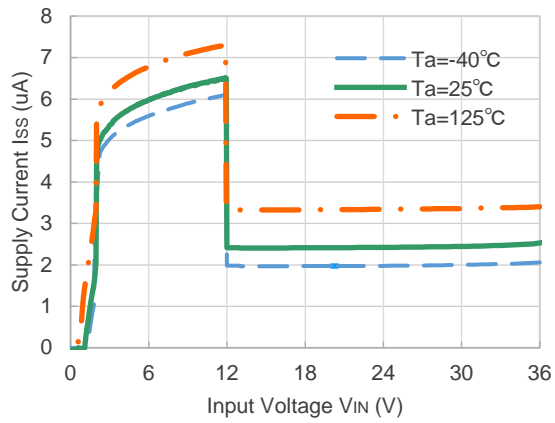

5) Output Voltage vs. Temperature ( $I_{OUT} = 1mA$ )

R1524x018B

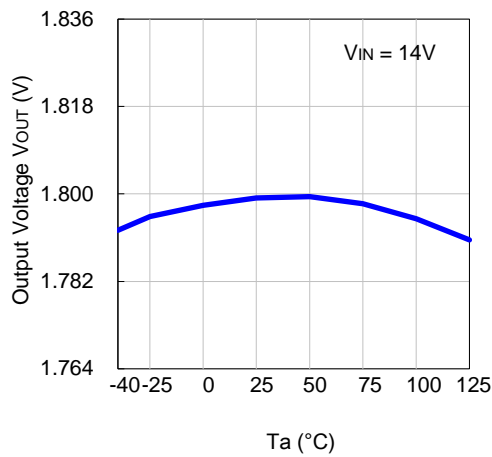

R1524x033B

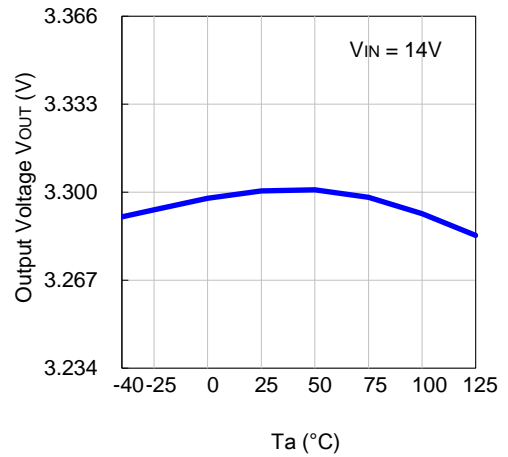

R1524x050B

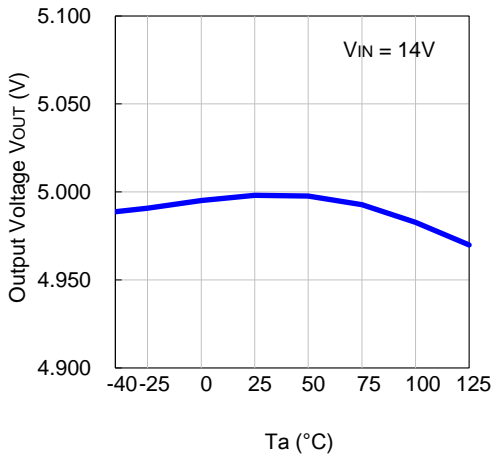

R1524x090B

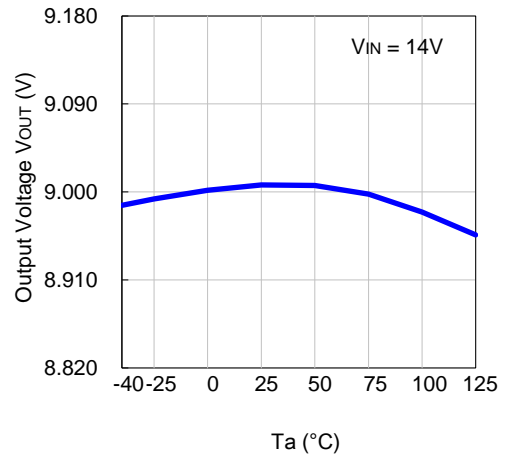

R1524x120B

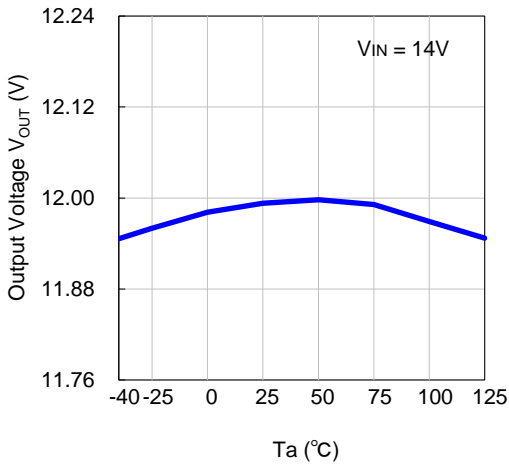

6) Dropout Voltage vs. Output Current

R1524x018B

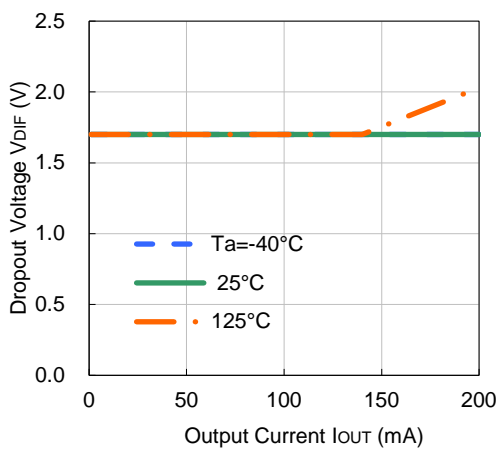

R1524x033B

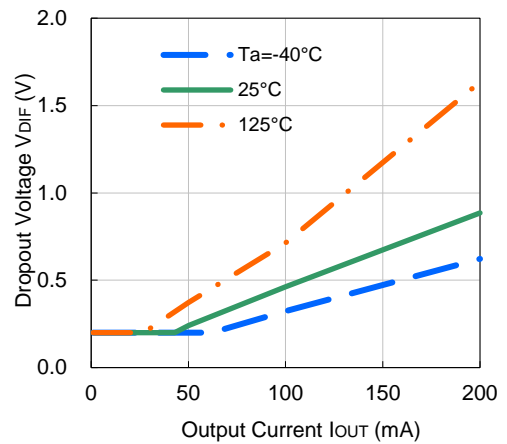



R1524x050B

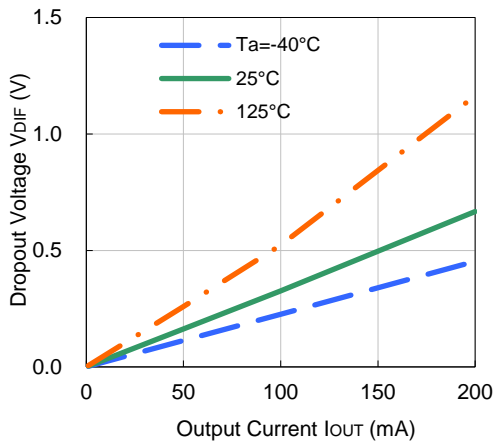

R1524x090B

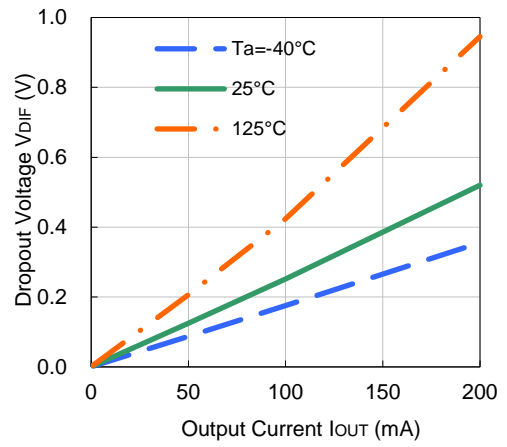

R1524x120B

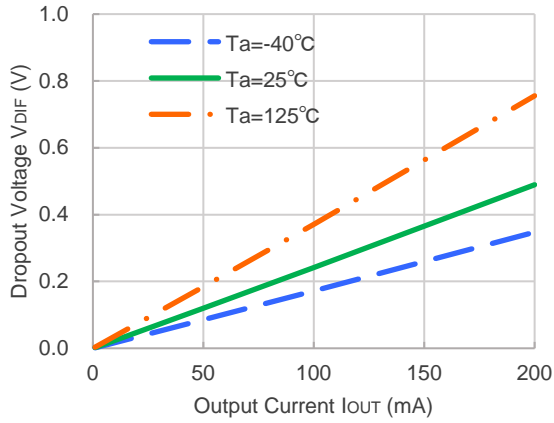

7) Dropout Voltage vs. Output Voltage ( $T_a = 25^\circ\text{C}$ )

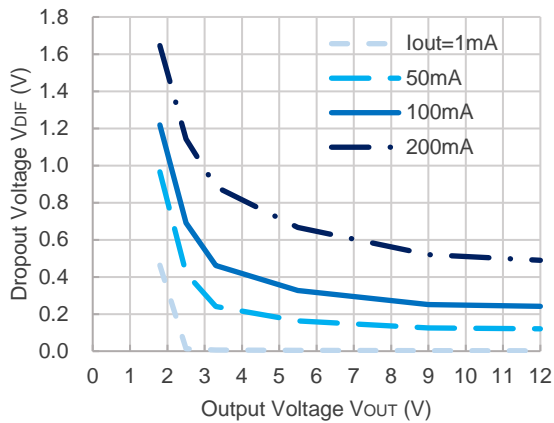

---

**R1524x**EC-332-200602

---

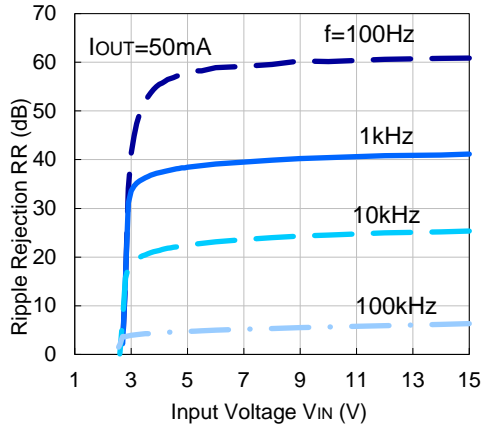
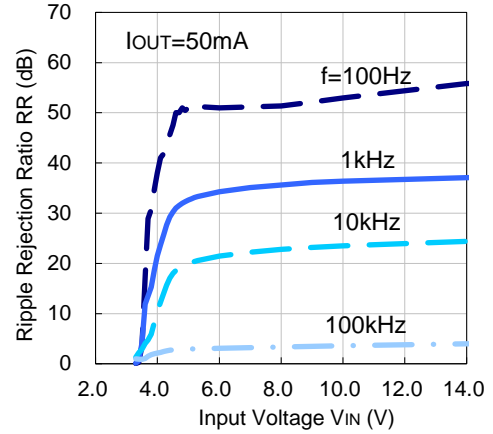
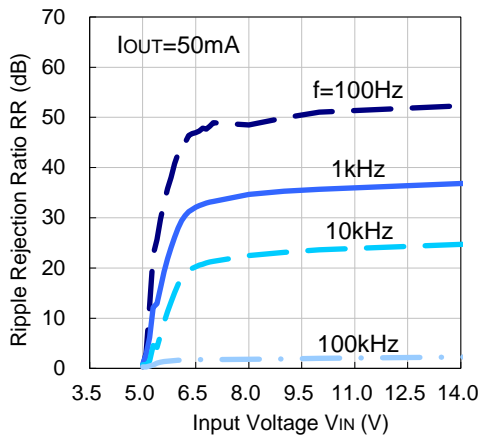
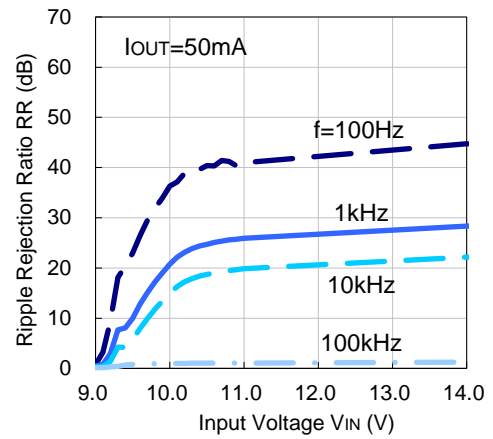
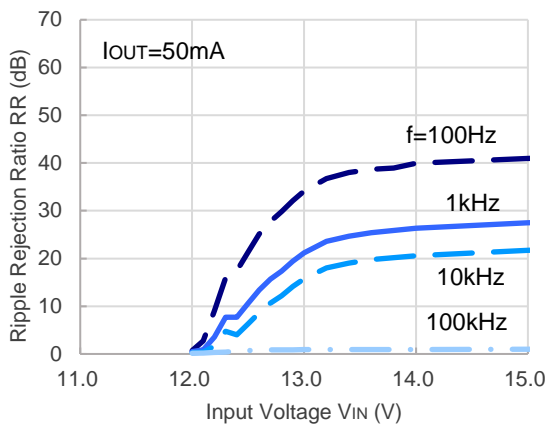
**8) Ripple Rejection vs. Input Voltage ( $T_a = 25^\circ\text{C}$ , Ripple = 0.2 Vpp)****R1524x018B****R1524x033B****R1524x050B****R1524x090B****R1524x120B**

9) Ripple Rejection vs. Frequency ( $T_a = 25^\circ\text{C}$ , Ripple = 0.2 Vpp)

R1524x018B

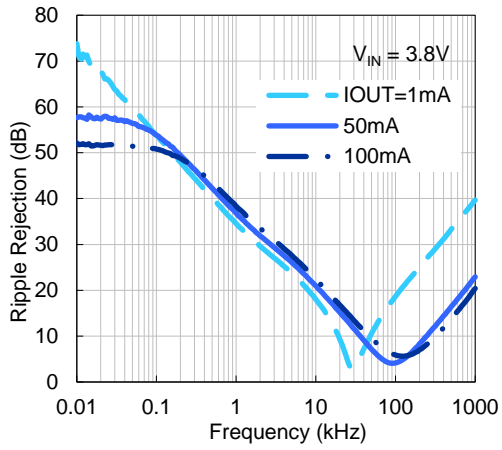

R1524x033B

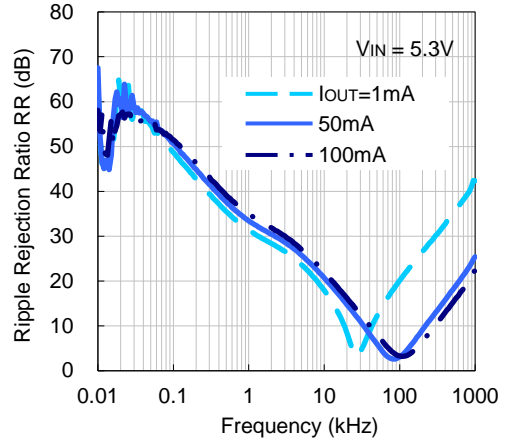

R1524x050B

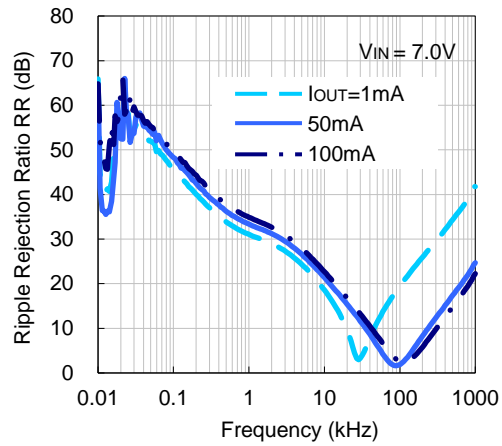

R1524x090B

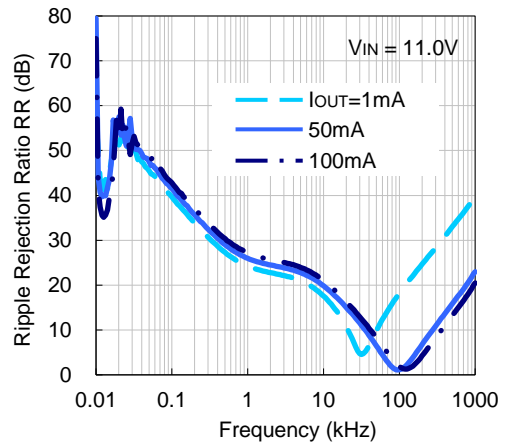

R1524x120B

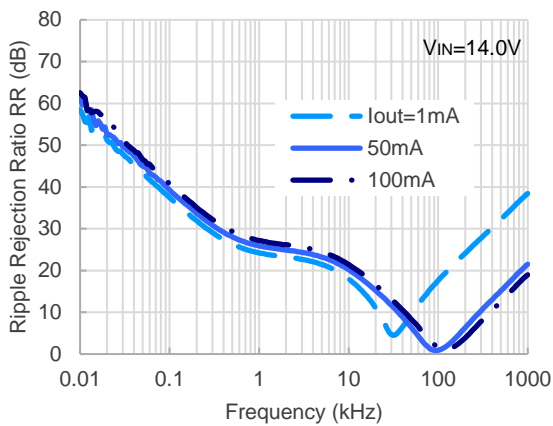

10) Input Transient Response (Ta = 25°C)

R1524x018B

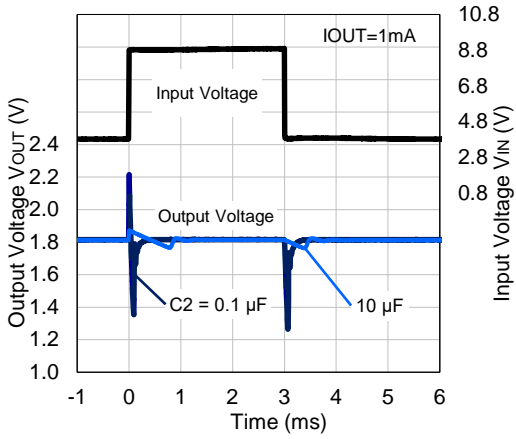

R1524x033B

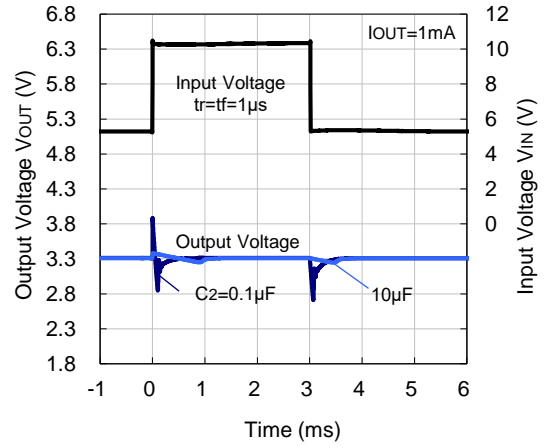

R1524x050B

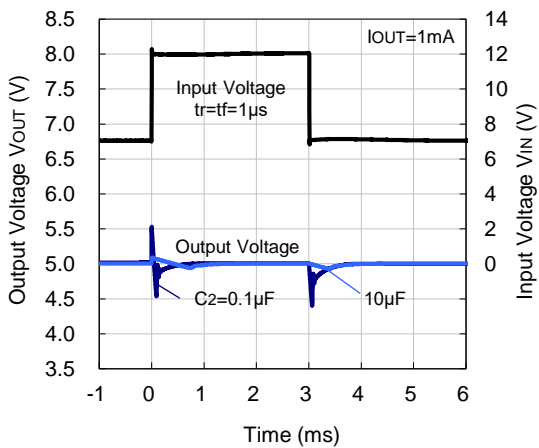

R1524x090B

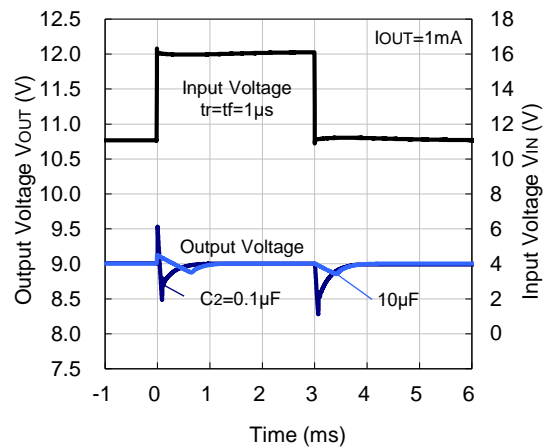

R1524x120B

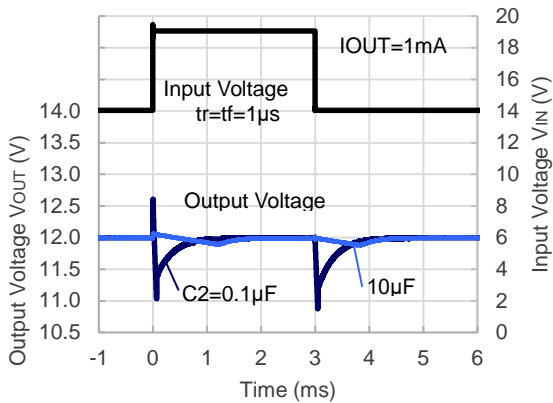

11) Load Transient Response (Ta = 25°C)

R1524x018B

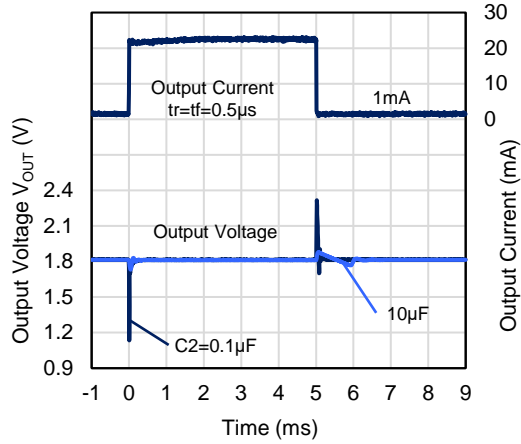

R1524x033B

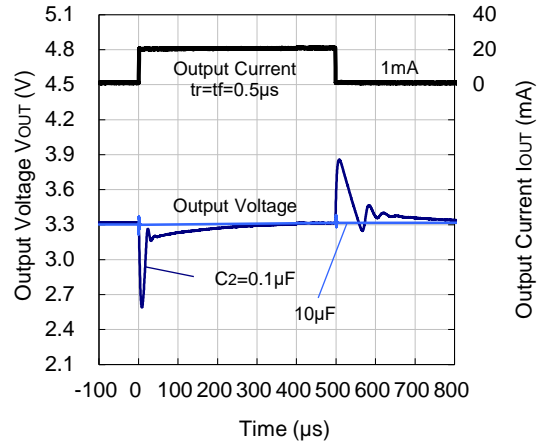

R1524x050B

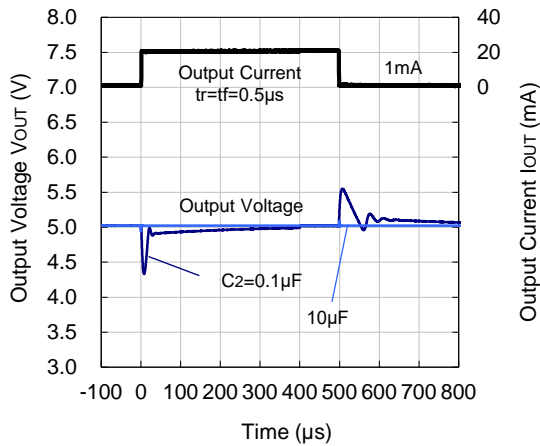

R1524x090B

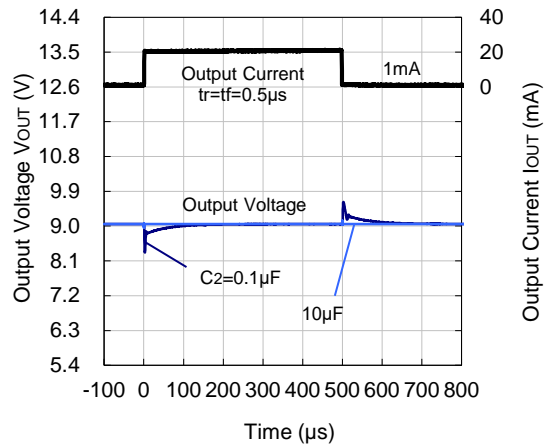

R1524x120B

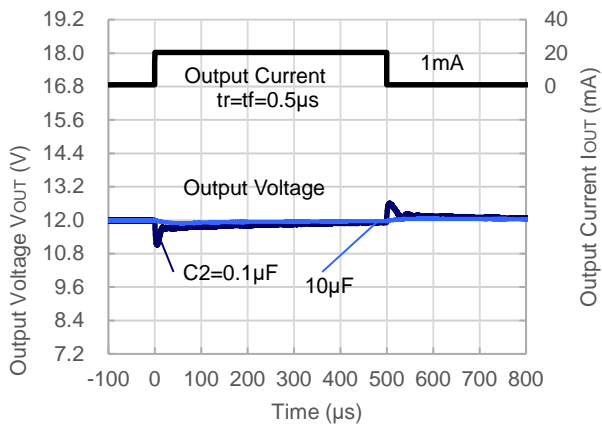

# R1524x

EC-332-200602

## 12) CE Transient Response ( $T_a = 25^\circ\text{C}$ )

### R1524x018B

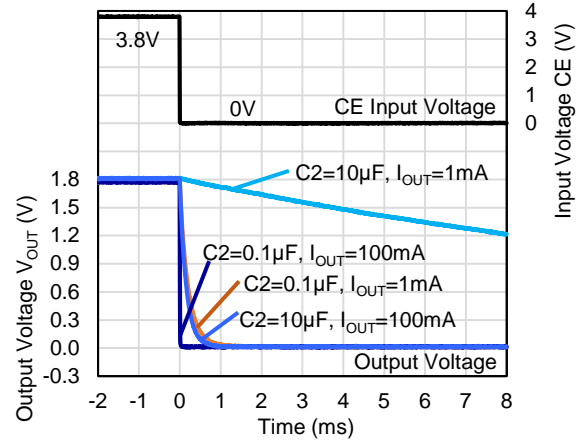
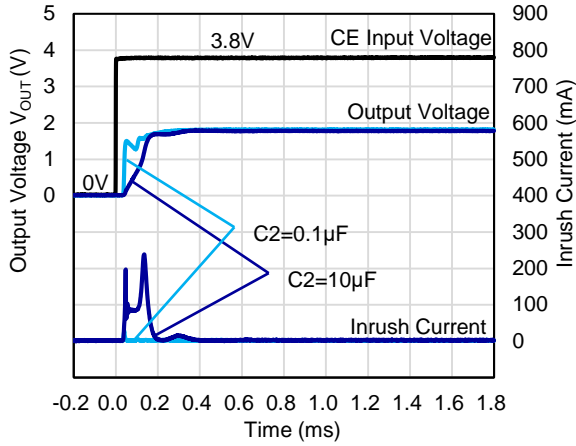

### R1524x033B

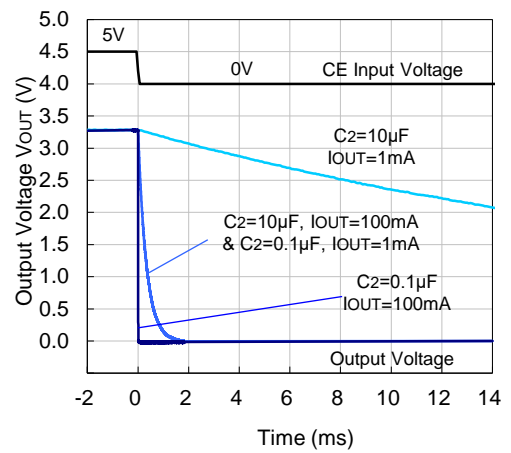
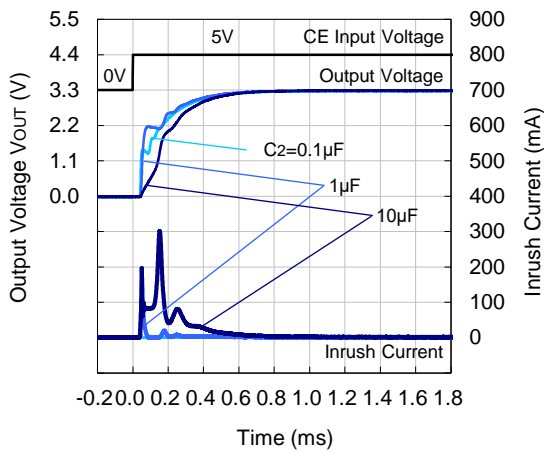

### R1524x050B

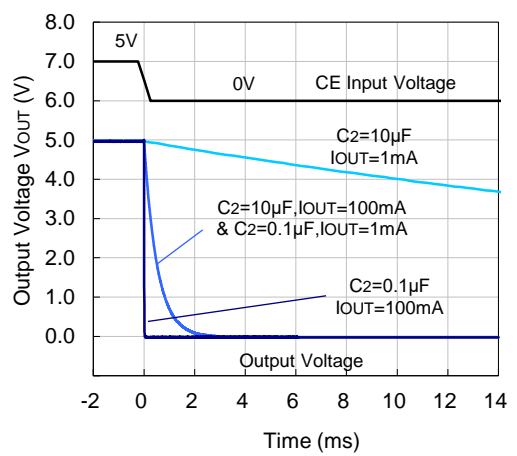
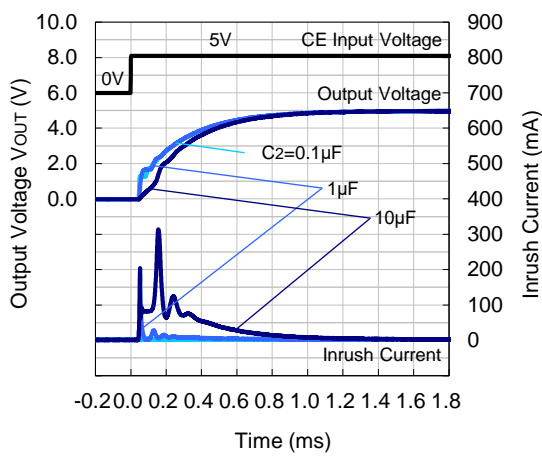

R1524x090B

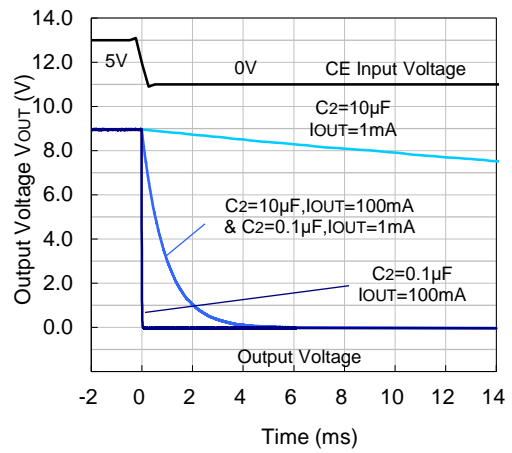
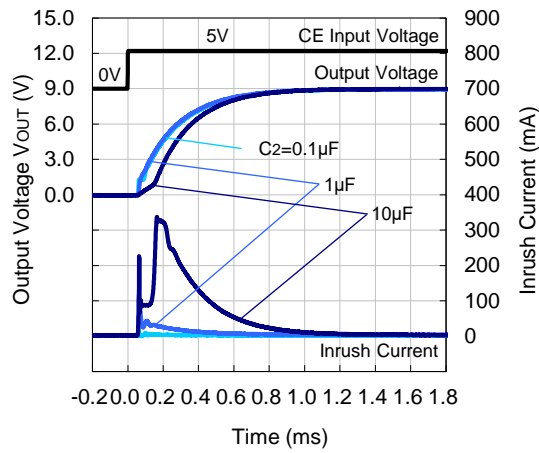

R1524x120B

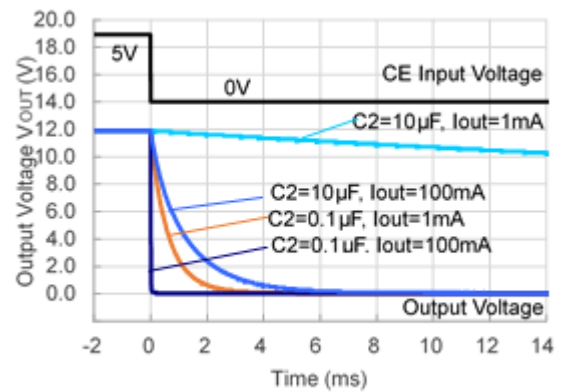
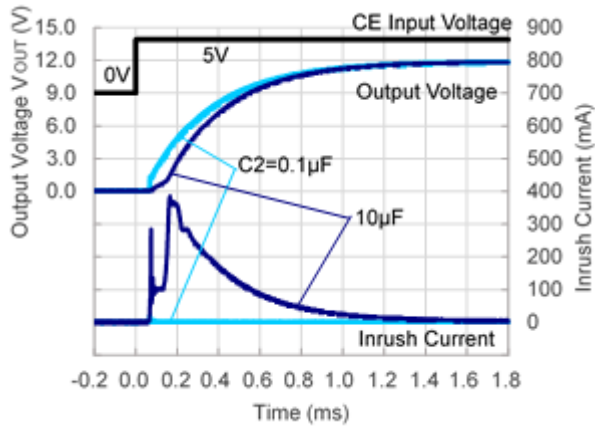

13) Power-on Transient Response ( $T_a = 25^\circ\text{C}$ ,  $V_{CE} = 5\text{ V}$ )

R1524x018B

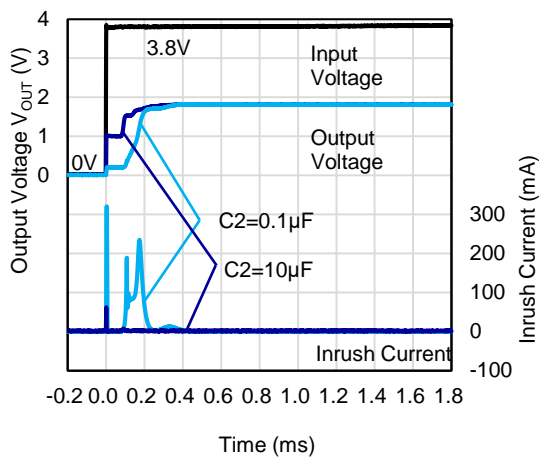

R1524x033B

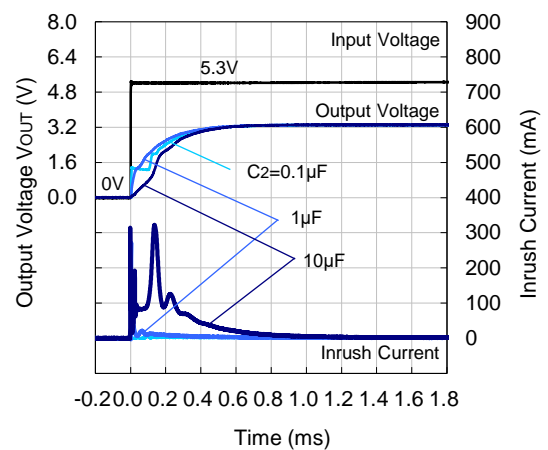

**R1524x050B**

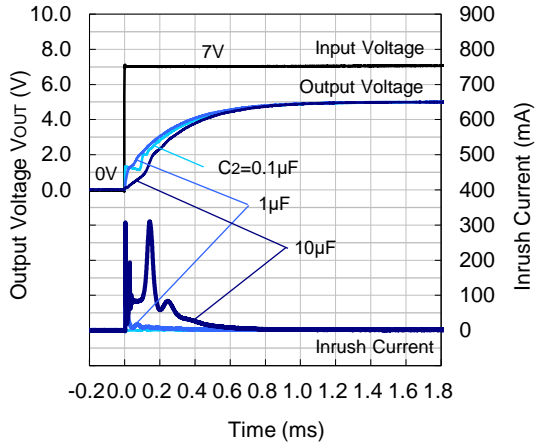

**R1524x090B**

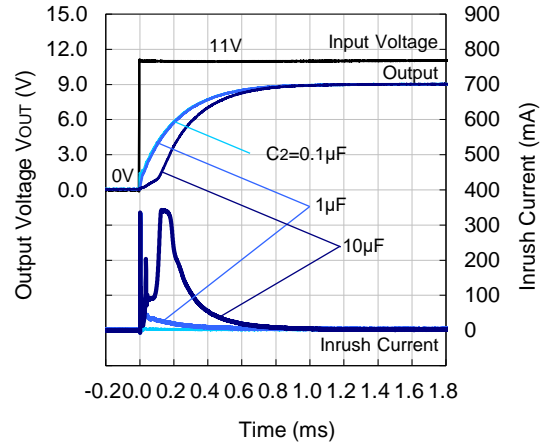

**R1524x120B**

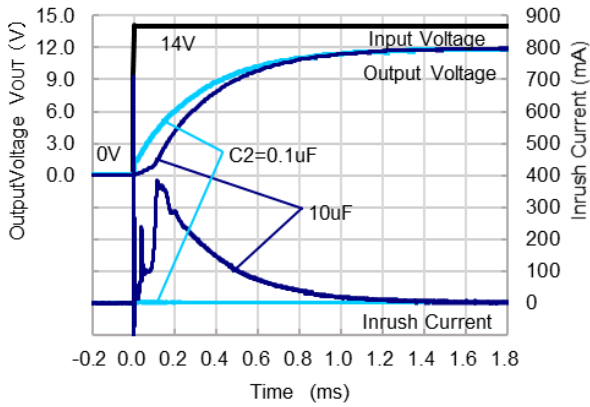

**14) Load Dump ( $T_a = 25^\circ C$ )**

**R1524x018B**

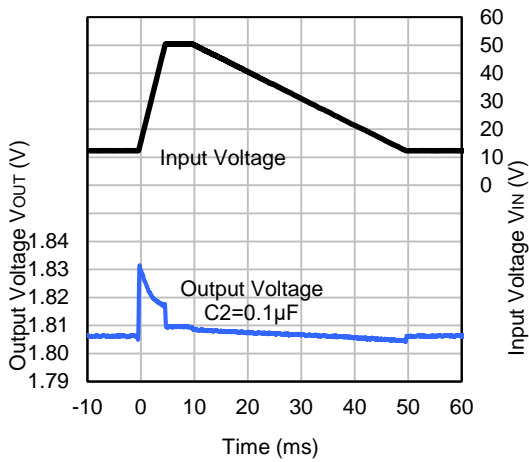

**R1524x033B**

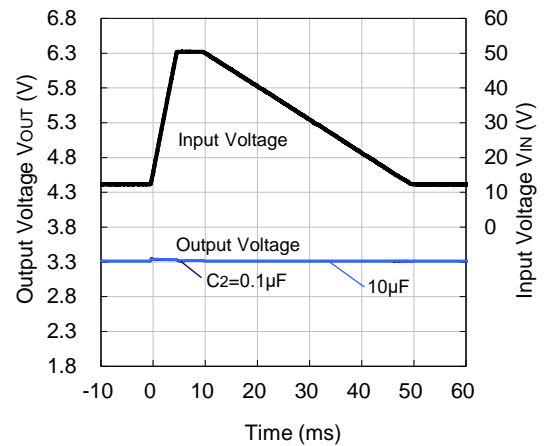



R1524x050B

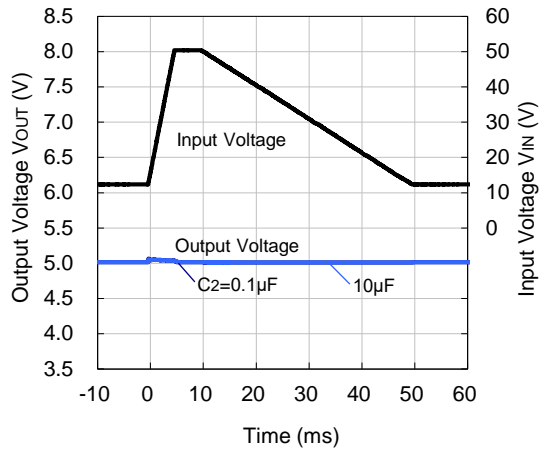

R1524x090B

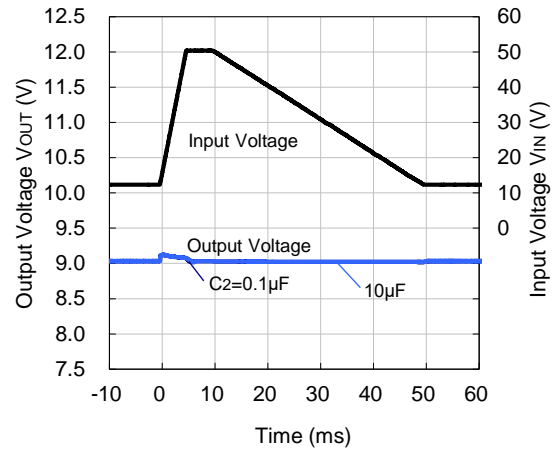

R1524x120B

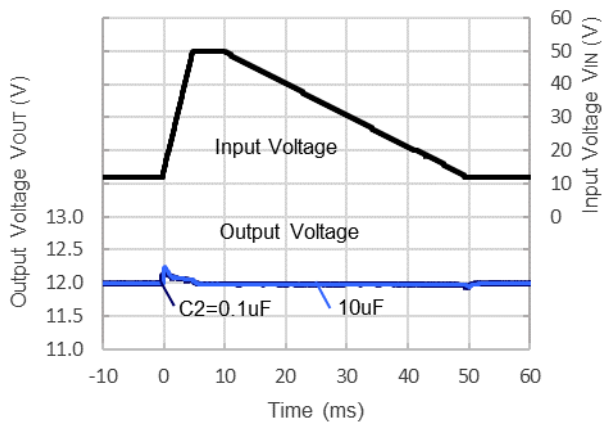

---

**R1524x**EC-332-200602

---

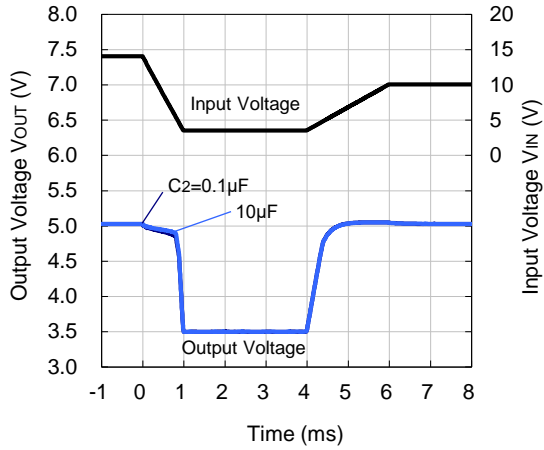
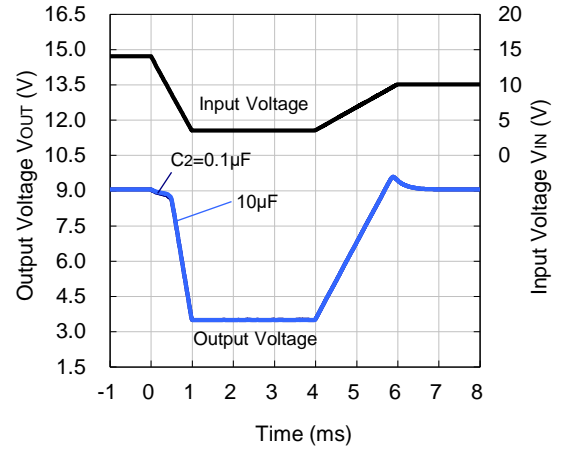
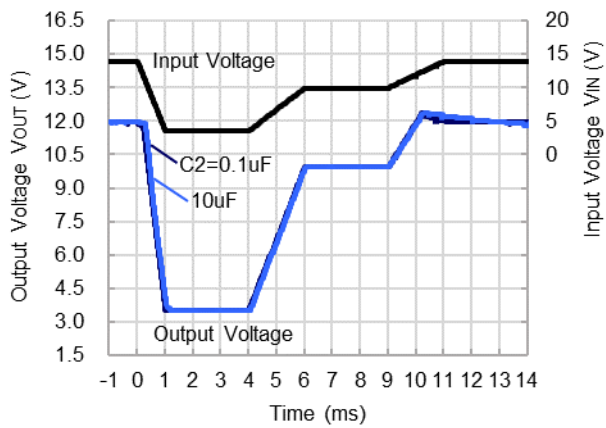
**15) Cranking (Ta = 25°C)****R1524x050B****R1524x090B****R1524x120B**

**Input Transient/Load Transient vs. Output Capacity (C2)**

R1524 performs a stable operation by using 0.1  $\mu\text{F}$  of ceramic capacitor as the output capacitor. However, the variation of output voltage may not meet the demand of the system when input voltage and load current vary. In such cases, the variation of output voltage can be minimized significantly by using 10  $\mu\text{F}$  or higher ceramic capacitor. When using an electrolytic capacitor for the output line, place the electrolytic capacitor outer side of the ceramic capacitor arranged close to the IC.

Input Transient Response

R1524x033B

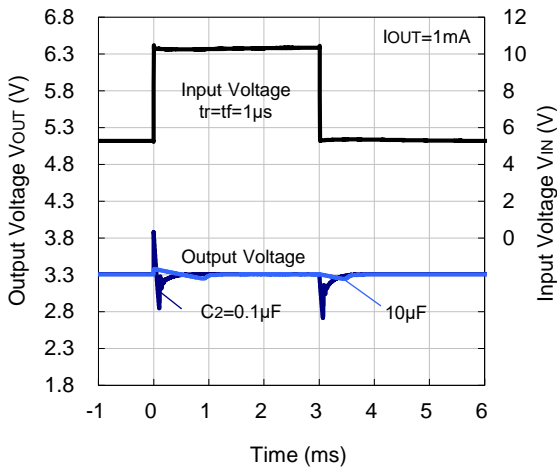

Load Transient Response

R1524x033B

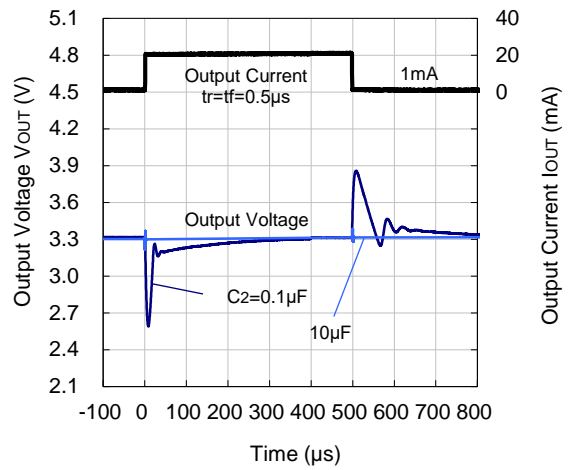

**ESR vs. Output Current**

It is recommended that a ceramic type capacitor be used for this device. However, other types of capacitors having lower ESR can also be used. The relation between the output current ( $I_{OUT}$ ) and the ESR of output capacitor is shown below.

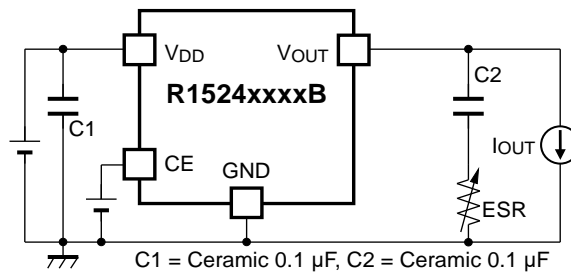

R1524x018B

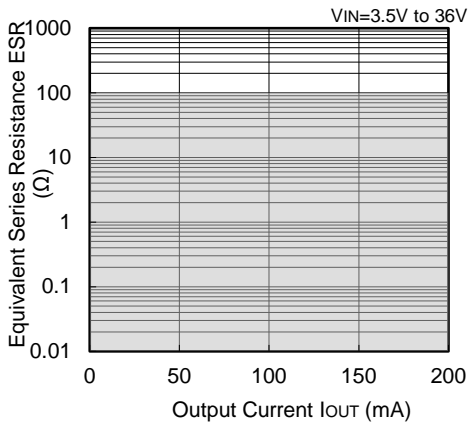

R1524x033B

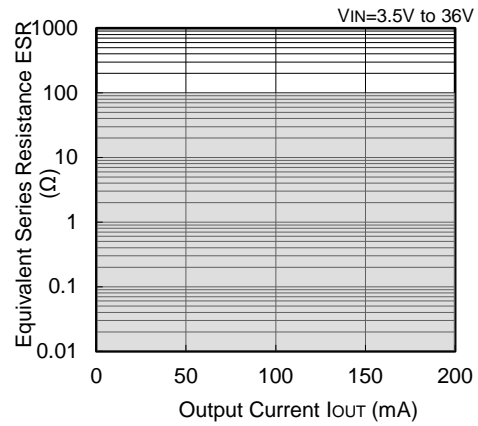

R1524x050B

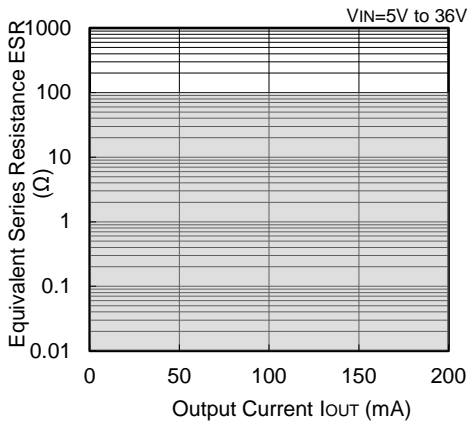

R1524x090B

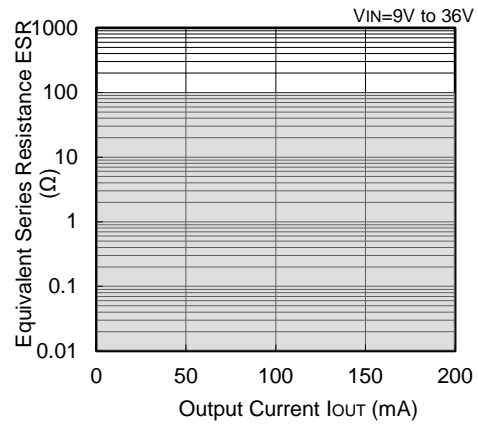

R1524x120B

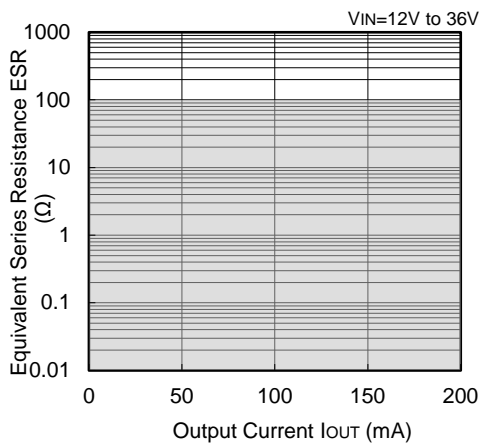

**Measurement Conditions**

Frequency Band: 10 Hz to 2 MHz

Measurement Temperature: -40°C to 125°C

Hatched area: Noise level is 40 μV (average) or below

Ceramic Capacitors:

C<sub>IN</sub> = 0.1 μF, Murata, GRM188R71H104JA93D

C<sub>OUT</sub> = 0.1 μF, TDK, CGA3E2X7R1E104K

The power dissipation of the package is dependent on PCB material, layout, and environmental conditions. The following measurement conditions are based on JEDEC STD. 51-7.

**Measurement Conditions**

Item	Measurement Conditions
Environment	Mounting on Board (Wind Velocity = 0 m/s)
Board Material	Glass Cloth Epoxy Plastic (Four-Layer Board)
Board Dimensions	76.2 mm × 114.3 mm × 0.8 mm
Copper Ratio	Outer Layer (First Layer): Less than 95% of 50 mm Square Inner Layers (Second and Third Layers): Approx. 100% of 50 mm Square Outer Layer (Fourth Layer): Approx. 100% of 50 mm Square
Through-holes	φ 0.3 mm × 7 pcs

**Measurement Result**

(Ta = 25°C, Tjmax = 150°C)

Item	Measurement Result
Power Dissipation	830 mW
Thermal Resistance (θja)	θja = 150°C/W
Thermal Characterization Parameter (ψjt)	ψjt = 51°C/W

θja: Junction-to-Ambient Thermal Resistance

ψjt: Junction-to-Top Thermal Characterization Parameter

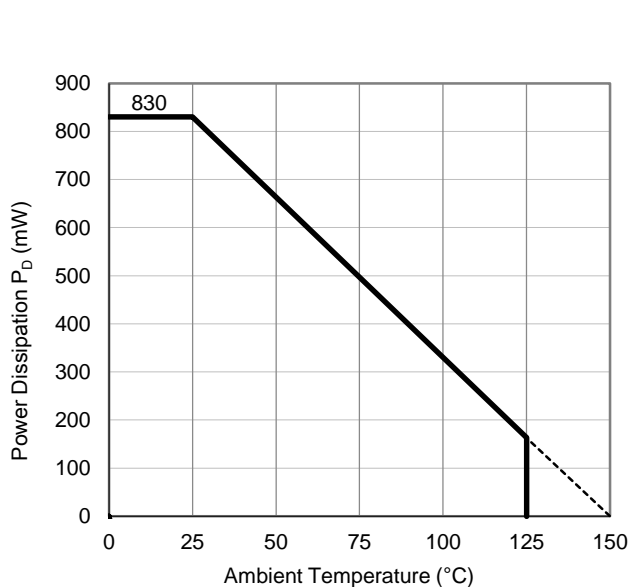

**Power Dissipation vs. Ambient Temperature**

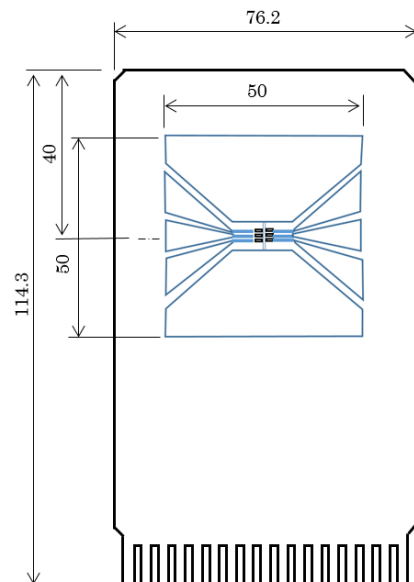

**Measurement Board Pattern**

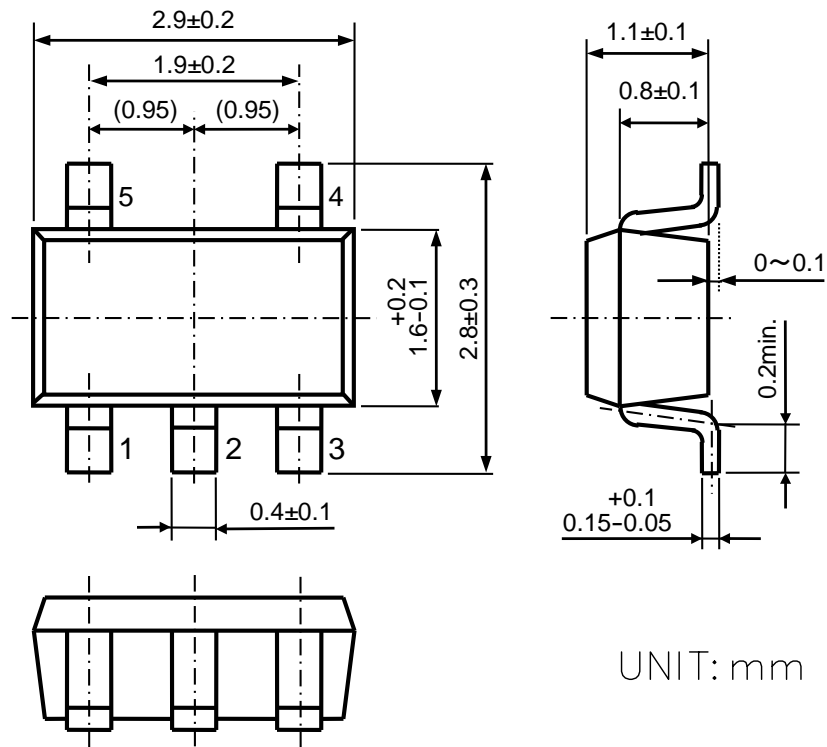

SOT-23-5 Package Dimensions

The power dissipation of the package is dependent on PCB material, layout, and environmental conditions. The following measurement conditions are based on JEDEC STD. 51-7.

**Measurement Conditions**

Item	Measurement Conditions
Environment	Mounting on Board (Wind Velocity = 0 m/s)
Board Material	Glass Cloth Epoxy Plastic (Four-Layer Board)
Board Dimensions	76.2 mm × 114.3 mm × 0.8 mm
Copper Ratio	Outer Layer (First Layer): Less than 95% of 50 mm Square Inner Layers (Second and Third Layers): Approx. 100% of 50 mm Square Outer Layer (Fourth Layer): Approx. 100% of 50 mm Square
Through-holes	φ 0.3 mm × 13 pcs

**Measurement Result**

(Ta = 25°C, Tjmax = 150°C)

Item	Measurement Result
Power Dissipation	3200 mW
Thermal Resistance (θja)	θja = 38°C/W
Thermal Characterization Parameter (ψjt)	ψjt = 13°C/W

θja: Junction-to-Ambient Thermal Resistance

ψjt: Junction-to-Top Thermal Characterization Parameter

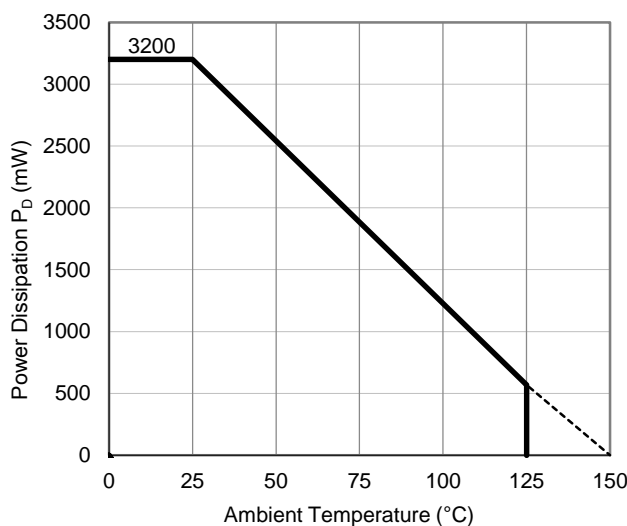

**Power Dissipation vs. Ambient Temperature**

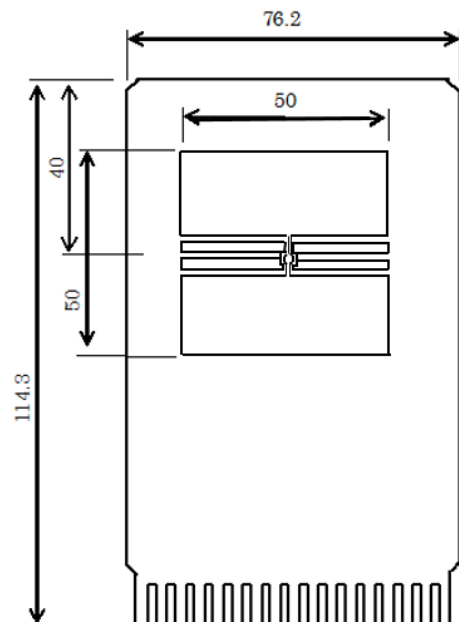

**Measurement Board Pattern**

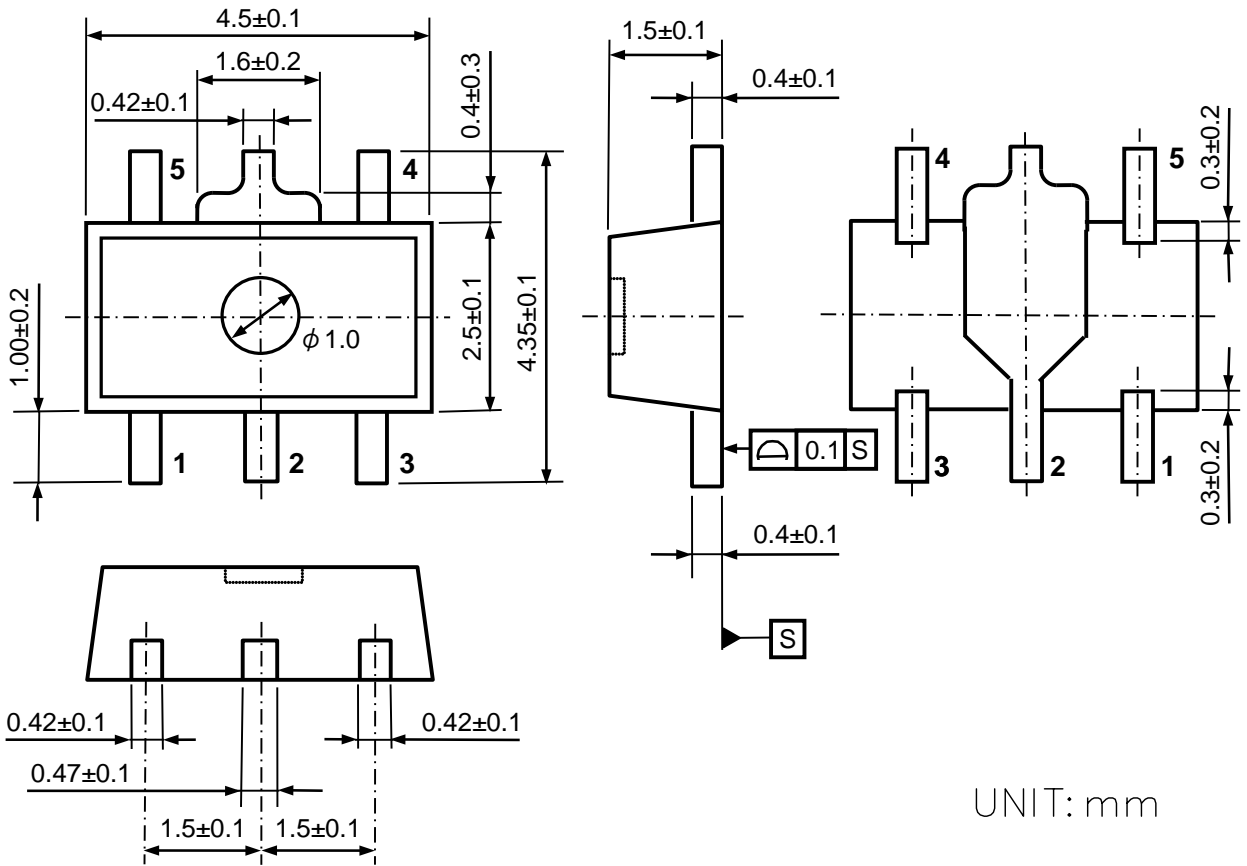

UNIT: mm

SOT-89-5 Package Dimensions



The power dissipation of the package is dependent on PCB material, layout, and environmental conditions. The following measurement conditions are based on JEDEC STD. 51-7.

**Measurement Conditions**

Item	Measurement Conditions
Environment	Mounting on Board (Wind Velocity = 0 m/s)
Board Material	Glass Cloth Epoxy Plastic (Four-Layer Board)
Board Dimensions	76.2 mm × 114.3 mm × 0.8 mm
Copper Ratio	Outer Layer (First Layer): Less than 95% of 50 mm Square Inner Layers (Second and Third Layers): Approx. 100% of 50 mm Square Outer Layer (Fourth Layer): Approx. 100% of 50 mm Square
Through-holes	φ 0.3 mm × 28 pcs

**Measurement Result**

(Ta = 25°C, Tjmax = 150°C)

Item	Measurement Result
Power Dissipation	3400 mW
Thermal Resistance ( $\theta_{ja}$ )	$\theta_{ja} = 37^{\circ}\text{C/W}$
Thermal Characterization Parameter ( $\psi_{jt}$ )	$\psi_{jt} = 7^{\circ}\text{C/W}$

$\theta_{ja}$ : Junction-to-Ambient Thermal Resistance

$\psi_{jt}$ : Junction-to-Top Thermal Characterization Parameter

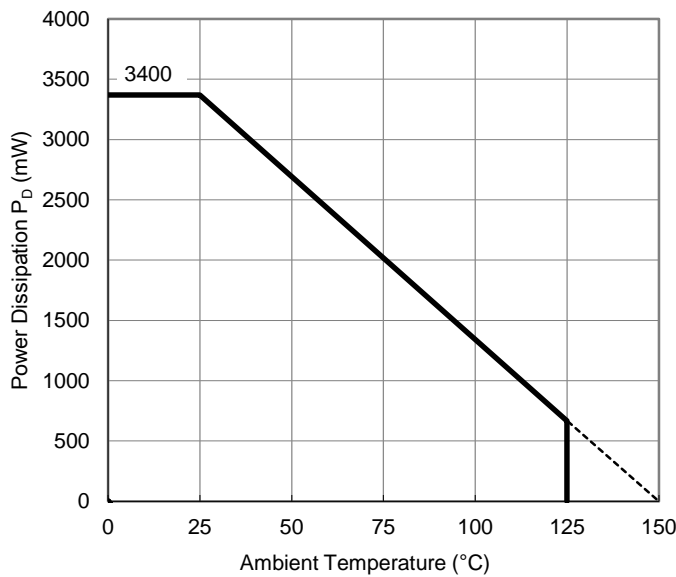

**Power Dissipation vs. Ambient Temperature**

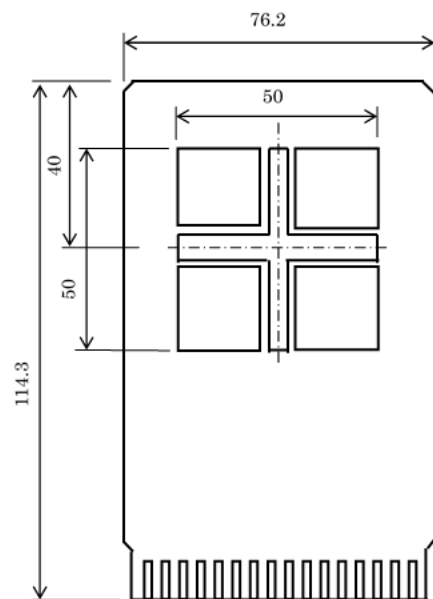

**Measurement Board Pattern**

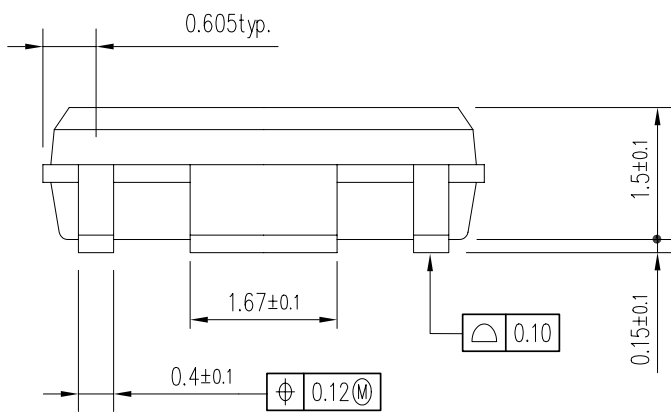
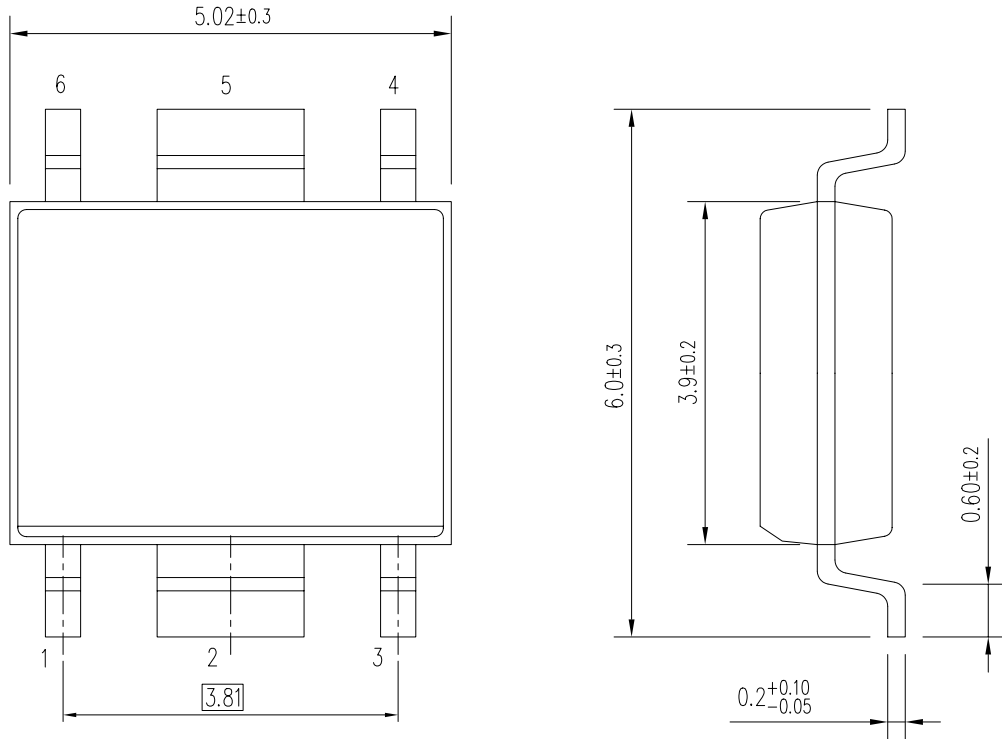

UNIT: mm

HSOP-6J Package Dimensions

The power dissipation of the package is dependent on PCB material, layout, and environmental conditions. The following measurement conditions are based on JEDEC STD. 51-7.

**Measurement Conditions**

Item	Measurement Conditions
Environment	Mounting on Board (Wind Velocity = 0 m/s)
Board Material	Glass Cloth Epoxy Plastic (Four-Layer Board)
Board Dimensions	76.2 mm × 114.3 mm × 0.8 mm
Copper Ratio	Outer Layer (First Layer): Less than 95% of 50 mm Square Inner Layers (Second and Third Layers): Approx. 100% of 50 mm Square Outer Layer (Fourth Layer): Approx. 100% of 50 mm Square
Through-holes	φ 0.3 mm × 21 pcs

**Measurement Result**

(Ta = 25°C, Tjmax = 150°C)

Item	Measurement Result
Power Dissipation	3600 mW
Thermal Resistance (θja)	θja = 34.5°C/W
Thermal Characterization Parameter (ψjt)	ψjt = 10°C/W

θja: Junction-to-Ambient Thermal Resistance

ψjt: Junction-to-Top Thermal Characterization Parameter

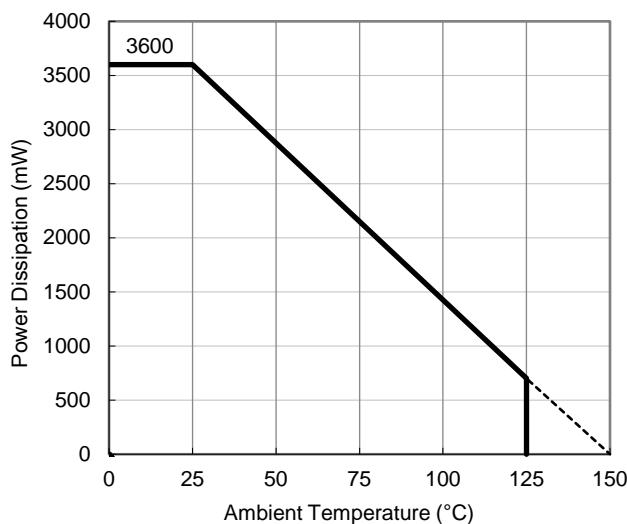

**Power Dissipation vs. Ambient Temperature**

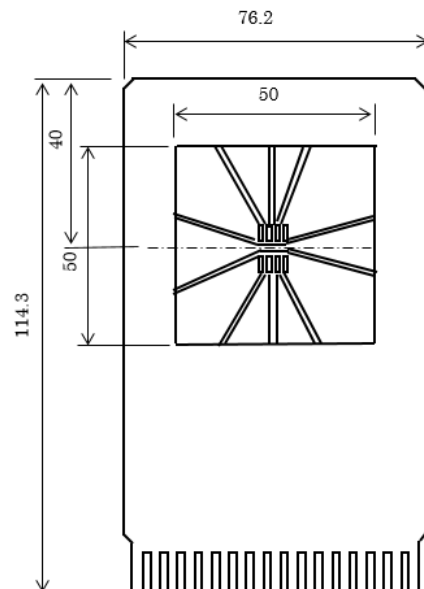

**Measurement Board Pattern**

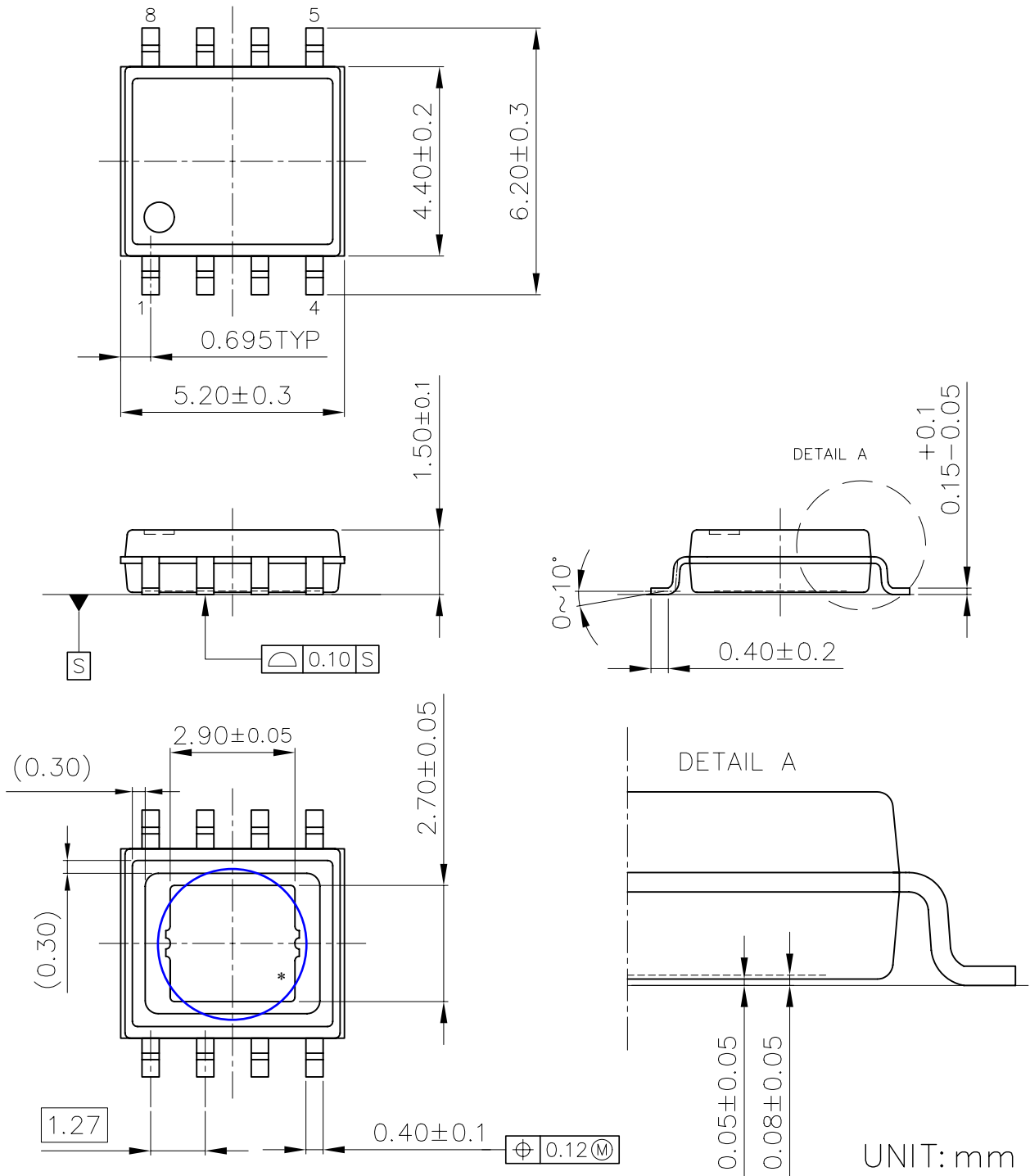

HSOP-8E Package Dimensions

\* The tab on the bottom of the package shown by blue circle is substrate potential (GND). It is recommended that this tab be connected to the ground plane on the board but it is possible to leave the tab floating.



1. The products and the product specifications described in this document are subject to change or discontinuation of production without notice for reasons such as improvement. Therefore, before deciding to use the products, please refer to Ricoh sales representatives for the latest information thereon.
2. The materials in this document may not be copied or otherwise reproduced in whole or in part without prior written consent of Ricoh.
3. Please be sure to take any necessary formalities under relevant laws or regulations before exporting or otherwise taking out of your country the products or the technical information described herein.
4. The technical information described in this document shows typical characteristics of and example application circuits for the products. The release of such information is not to be construed as a warranty of or a grant of license under Ricoh's or any third party's intellectual property rights or any other rights.
5. The products in this document are designed for automotive applications. However, when using the products for automotive applications, please make sure to contact Ricoh sales representative in advance due to confirming the quality level.
6. We are making our continuous effort to improve the quality and reliability of our products, but semiconductor products are likely to fail with certain probability. In order to prevent any injury to persons or damages to property resulting from such failure, customers should be careful enough to incorporate safety measures in their design, such as redundancy feature, fire containment feature and fail-safe feature. We do not assume any liability or responsibility for any loss or damage arising from misuse or inappropriate use of the products.
7. Anti-radiation design is not implemented in the products described in this document.
8. The X-ray exposure can influence functions and characteristics of the products. Confirm the product functions and characteristics in the evaluation stage.
9. WLCSP products should be used in light shielded environments. The light exposure can influence functions and characteristics of the products under operation or storage.
10. There can be variation in the marking when different AOI (Automated Optical Inspection) equipment is used.  
In the case of recognizing the marking characteristic with AOI, please contact Ricoh sales or our distributor before attempting to use AOI.
11. Please contact Ricoh sales representatives should you have any questions or comments concerning the products or the technical information.



**Ricoh is committed to reducing the environmental loading materials in electrical devices with a view to contributing to the protection of human health and the environment.**

Ricoh has been providing RoHS compliant products since April 1, 2006 and Halogen-free products since April 1, 2012.

**RICOH** RICOH ELECTRONIC DEVICES CO., LTD.

**Official website**

<https://www.n-redc.co.jp/en/>

**Contact us**

<https://www.n-redc.co.jp/en/buy/>

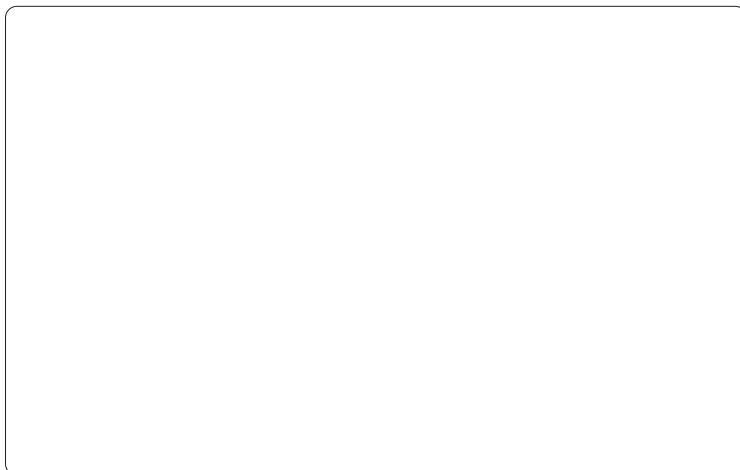

# Mouser Electronics

Authorized Distributor

Click to View Pricing, Inventory, Delivery & Lifecycle Information:

## Ricoh Electronics:

[R1524S050B-E2-KE](#) [R1524S033B-E2-KE](#) [R1524H033B-T1-KE](#) [R1524H050B-T1-KE](#) [R1524N033B-TR-KE](#)  
[R1524N050B-TR-KE](#) [R1524S055B-E2-KE](#) [R1524H060B-T1-KE](#) [R1524S060B-E2-KE](#) [R1524S090H-E2-KE](#)  
[R1524N025B-TR-KE](#) [R1524S075B-E2-KE](#) [R1524S050H-E2-KE](#) [R1524N080B-TR-KE](#) [R1524S090B-E2-KE](#)  
[R1524N090B-TR-KE](#) [R1524H090B-T1-KE](#) [R1524H018B-T1-KE](#) [R1524N060B-TR-KE](#) [R1524S033H-E2-KE](#)  
[R1524S080B-E2-KE](#) [R1524S100B-E2-KE](#) [R1524S110B-E2-KE](#)