

Fixed Voltage Series - DO-214 (pxxx1s)



Agency Approvals

Agency	Agency File Number
	E133083

Pinout Designation



Schematic Symbol

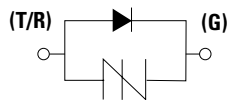

Description

Fixed Voltage Series DO-214 (pxxx1s) are uni-directional SIDACtor® components designed to protect SLICs (Subscriber Line Interface Circuit) from damaging overvoltage transients. The series provides single line protection using a fixed voltage switching component for negative surges. All positive surges are routed through an internal diode to a ground reference.

Features and Benefits

- RoHS compliant, lead-free, and halogen-free
- Low voltage overshoot
- Low on-state voltage
- Does not degrade surge capability after multiple surge events within limit.
- Fails short circuit when surged in excess of ratings
- Integrated diode for positive voltage surges
- Pb-free E3 means 2nd level interconnect is Pb-free and the terminal finish material is tin(Sn) (IPC/JEDEC J-STD-609A.01)

Applicable Global Standards

- TIA-968-A
- TIA-968-B
- ITU K.20/21 Enhanced Level
- ITU K.20/21 Basic Level
- GR 1089 Intra-building*
- IEC 61000-4-5 2nd edition
- YD/T 1082
- YD/T 993
- YD/T 950

*A-rated parts require series resistance

Electrical Characteristics

Part Number	Marking	V_{DRM} @ $I_{DRM}=5\mu A$	V_S @ 100V/ μs	I_H	I_S	I_T	V_T @ $I_T=2.2$ Amps	V_F	Capacitance @ 1MHz, -2V bias	
		V min	V max	mA min	mA max	A max	V max	V max	pF	
										pF min
P0181SALRP	P018A	18	40	100	800	2.2	4	5	30	90
P0641SALRP	P61A	58	77	120	800	2.2	4	5	50	90
P0721SALRP	P71A	65	88	120	800	2.2	4	5	45	85
P0901SALRP	P91A	75	98	120	800	2.2	4	5	45	80
P1101SALRP	P01A	95	130	120	800	2.2	4	5	40	70
P1301SALRP	P131A	120	160	120	800	2.2	4	5	40	70
P1701SALRP	P17A	160	200	120	800	2.2	4	5	30	55
P0641SCLRP	P61C	58	77	120	800	2.2	4	5	65	200
P0721SCLRP	P71C	65	88	120	800	2.2	4	5	60	190
P0901SCLRP	P91C	75	98	120	800	2.2	4	5	60	180
P1101SCLRP	P01C	95	130	120	800	2.2	4	5	50	160
P1201SCLRP	P121C	105	140	120	800	2.2	4	5	50	160
P1301SCLRP	P131C	120	160	120	800	2.2	4	5	50	160
P1701SCLRP	P17C	160	200	120	800	2.2	4	5	40	130
P0641SDLRP	P61D	58	77	120	800	2.2	4	5	65	200
P0721SDLRP	P71D	65	88	120	800	2.2	4	5	60	190
P0901SDLRP	P91D	75	98	120	800	2.2	4	5	60	180
P1101SDLRP	P01D	95	130	120	800	2.2	4	5	50	160
P1301SDLRP	P131D	120	160	120	800	2.2	4	5	50	160
P1701SDLRP	P17D	160	200	120	800	2.2	4	5	40	130

Notes:
- Absolute maximum ratings measured at $T_J = 25^\circ C$ (unless otherwise noted).
- Components are not appropriate for positive ringing systems.

Surge Ratings

Series	I_{PP}									I_{TSM} 50/60 Hz	di/dt
	0.2/310 ¹ 0.5/700 ²	2/10 ^{1,3} 2/10 ²	8/20 ¹ 1.2/50 ²	10/160 ¹ 10/160 ²	10/560 ¹ 10/560 ²	5/320 ¹ 9/720 ²	10/360 ¹ 10/360 ²	10/1000 ¹ 10/1000 ²	5/310 ¹ 10/700 ²		
	A min	A min	A min	A min	A min	A min	A min	A min	A min	A min	A/μs max
A	20	150	150	90	50	75	75	45	75	20	500
C	50	500	400	200	150	200	175	100	200	30	500
D	—	1000	800	—	—	—	—	200	350	50	1000

Notes:

- 1 Current waveform in μs
- 2 Voltage waveform in μs
- 3 2/10 of P0641SDLRP and P0721SDLRP is 800A min
- Peak pulse current rating (I_{PP}) is repetitive and guaranteed for the life of the product that remains in thermal equilibrium.
- I_{PP} ratings applicable over temperature range of -40°C to +85°C
- The component must initially be in thermal equilibrium with -40°C ≤ T_J ≤ +150°C

Thermal Considerations

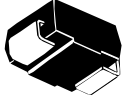
Package	Symbol	Parameter	Value	Unit
DO-214AA 	T_J	Operating Junction Temperature Range	-40 to +150	°C
	T_S	Storage Temperature Range	-65 to +150	°C
	$R_{θJA}$	Thermal Resistance: Junction to Ambient	90	°C/W

V-I Characteristics

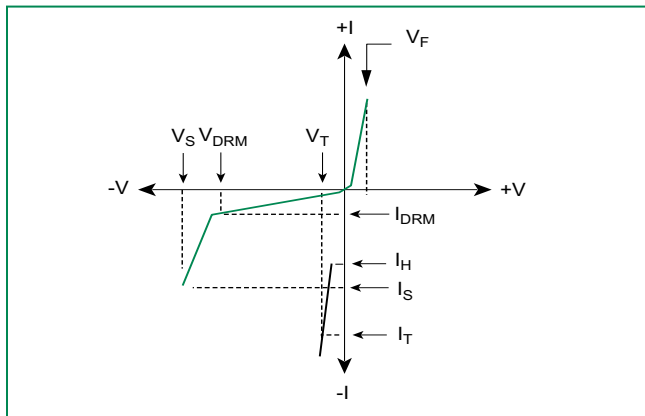

$t_r \times t_d$ Pulse Waveform

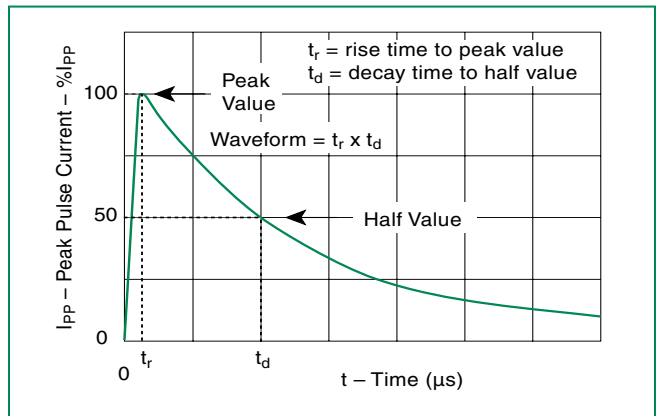

Normalized V_S Change vs. Junction Temperature

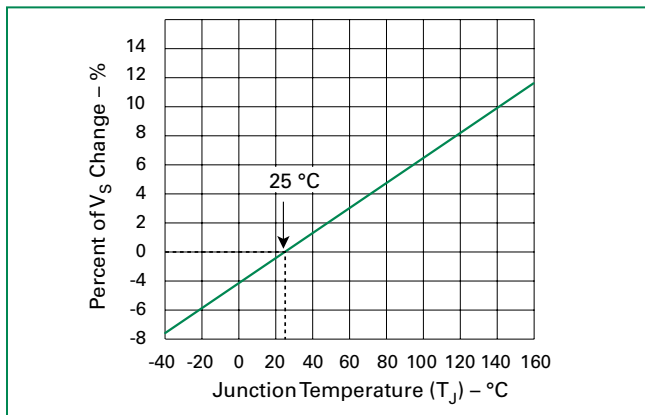

Normalized DC Holding Current vs. Case Temperature

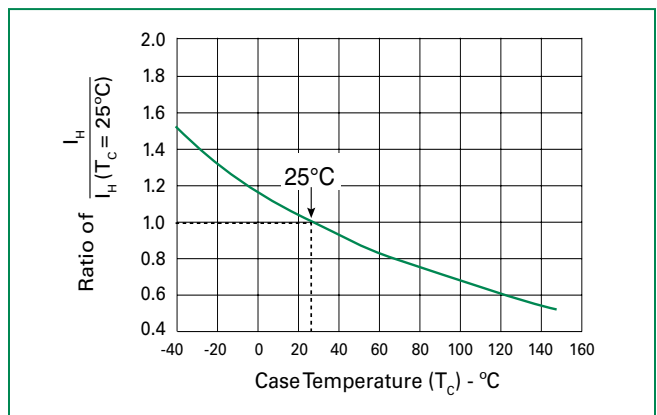

Soldering Parameters

Reflow Condition	Pb-Free assembly (see Fig. 1)	
Pre Heat	-Temperature Min ($T_{s(min)}$)	+150°C
	-Temperature Max ($T_{s(max)}$)	+200°C
	-Time (Min to Max) (t_s)	60-180 secs.
Average ramp up rate (Liquidus Temp (T_L) to peak)	3°C/sec. Max.	
$T_{s(max)}$ to T_L - Ramp-up Rate	3°C/sec. Max.	
Reflow	-Temperature (T_L) (Liquidus)	+217°C
	-Temperature (t_L)	60-150 secs.
Peak Temp (T_p)	+260(+0/-5)°C	
Time within 5°C of actual PeakTemp (t_p)	30 secs. Max.	
Ramp-down Rate	6°C/sec. Max.	
Time 25°C to Peak Temp (T_p)	8 min. Max.	
Do not exceed	+260°C	

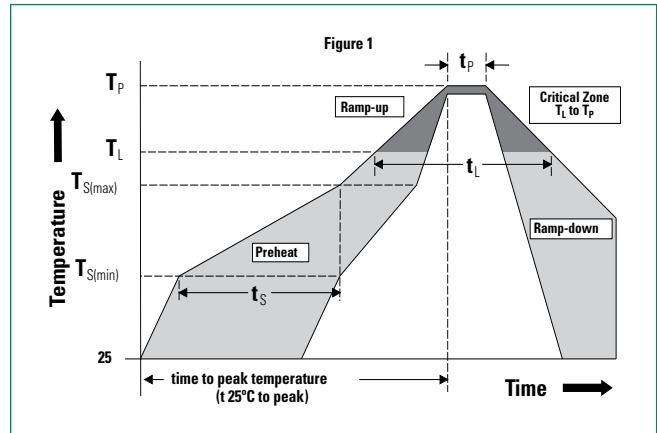

Physical Specifications

Lead Material	Copper Alloy
Terminal Finish	100% Matte-Tin Plated
Body Material	UL recognized epoxy meeting flammability classification V-0

Environmental Specifications

High Temp Voltage Blocking	80% Rated V_{DRM} (V_{AC} Peak) +125°C or +150°C, 504 or 1008 hrs. MIL-STD-750 (Method 1040) JEDEC, JESD22-A-101
Temp Cycling	-65°C to +150°C, 15 min. dwell, 10 up to 100 cycles. MIL-STD-750 (Method 1051) EIA/JEDEC, JESD22-A104
Biased Temp & Humidity	52 V_{DC} (+85°C) 85%RH, 504 up to 1008 hrs. EIA/JEDEC, JESD22-A-101
High Temp Storage	+150°C 1008 hrs. MIL-STD-750 (Method 1031) JEDEC, JESD22-A-101
Low Temp Storage	-65°C, 1008 hrs.
Thermal Shock	0°C to +100°C, 5 min. dwell, 10 sec. transfer, 10 cycles. MIL-STD-750 (Method 1056) JEDEC, JESD22-A-106
Autoclave (Pressure Cooker Test)	+121°C, 100%RH, 2atm, 24 up to 168 hrs. EIA/JEDEC, JESD22-A-102
Resistance to Solder Heat	+260°C, 30 secs. MIL-STD-750 (Method 2031)
Moisture Sensitivity Level	85%RH, +85°C, 168 hrs., 3 reflow cycles (+260°C Peak). JEDEC-J-STD-020, Level 1

Additional Information



Datasheet



Resources



Samples

Part Numbering

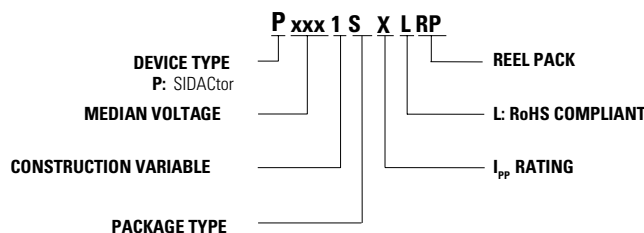

Part Marking

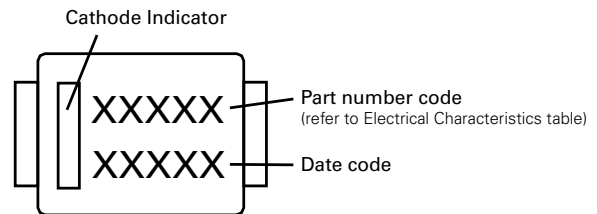

Dimensions — DO-214AA

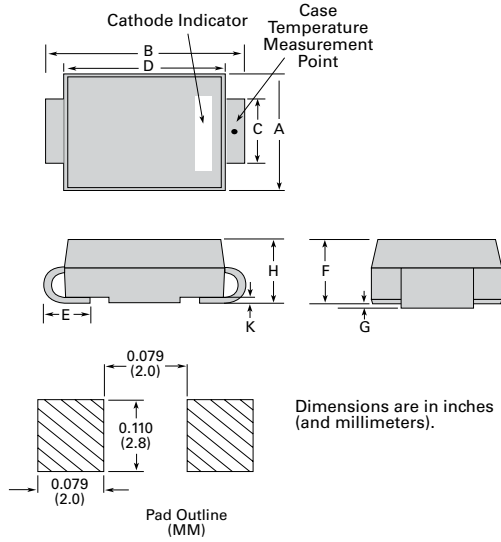

Dimensions	Inches		Millimeters	
	Min	Max	Min	Max
A	0.130	0.156	3.30	3.95
B	0.201	0.220	5.10	5.60
C	0.077	0.087	1.95	2.20
D	0.159	0.181	4.05	4.60
E	0.030	0.063	0.75	1.60
F	0.075	0.096	1.90	2.45
G	0.002	0.008	0.05	0.20
H	0.077	0.104	1.95	2.65
K	0.006	0.016	0.15	0.41

Packing Options

Package Type	Description	Quantity	Added Suffix	Industry Standard
S	DO-214AA Tape & Reel Pack	2500	RP	EIA-481-D

Tape and Reel Specification — DO-214AA

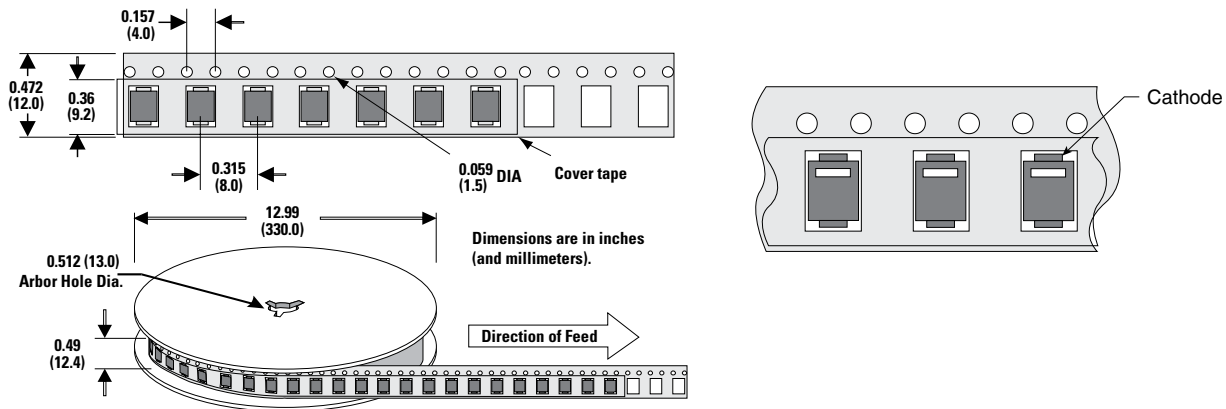

Disclaimer notice - littelfuse products are not designed for, and shall not be used for, any purpose (including, without limitation, automotive, military, aerospace, medical, life-saving, life-sustaining or nuclear facility applications, Devices intended for surgical implant into the body, or any other application in which the failure or lack of desired operation of the product may result in personal injury, death, or property damage) other than those expressly set forth in applicable littelfuse product documentation. Warranties granted by littelfuse shall be deemed void for products used for any purpose not expressly set forth in applicable littelfuse documentation. Littelfuse shall not be liable for Any claims or damages arising out of products used in applications not expressly intended by littelfuse as set forth in applicable littelfuse documentation. The sale and use of littelfuse products is subject to littelfuse terms and Conditions of sale, unless otherwise agreed by littelfuse. "Littelfuse" includes littelfuse, inc., And all of its affiliate entities. <http://www.Littelfuse.Com/disclaimer-electronics>

Mouser Electronics

Authorized Distributor

Click to View Pricing, Inventory, Delivery & Lifecycle Information:

Littelfuse:

[P0721SC](#) [P1101SA](#) [P0721SA](#) [P0901SC](#) [P0901SA](#) [P1101SC](#) [P0641SC](#) [P0901SCR](#) [P0721SAR](#) [P0641SCR](#)
[P0901SAR](#) [P1101SCL](#) [P1101SAL](#) [P1701SAL](#) [P1701SAR](#) [P0721SAL](#) [P0901SAL](#) [P0641SAL](#)
[P0721SCR](#) [P1101SAR](#) [P1101SCR](#) [P1701SCR](#) [P0641SAR](#) [P0641SBL](#) [P0721SBL](#) [P0901SBL](#)
[P1101SBL](#) [P1301SCL](#) [P1101SBR](#) [P0641SCL](#) [P0901SB](#) [P1101SB](#) [P0641SB](#) [P0641SBR](#)
[P0901SCL](#) [P1701SCL](#) [P0721SBR](#) [P0721SB](#) [P0721SCL](#) [P0901SBR](#) [P1301SAL](#) [P2601SDL](#)
[P0181SAL](#) [P3101SDL](#) [P1101SDL](#) [P1301SDL](#) [P0901SDL](#) [P1201SCL](#) [P1701SDL](#)