

### Features

- 1700-Volt Schottky Rectifier
- Zero Reverse Recovery Current
- Zero Forward Recovery Voltage
- High-Frequency Operation
- Temperature-Independent Switching Behavior
- Extremely Fast Switching
- Halogen-Free; RoHS Compliant

### Package

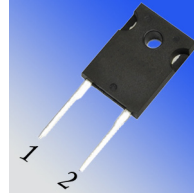

TO-247-2



### Benefits

- Replace Bipolar with Unipolar Rectifiers
- Essentially No Switching Losses
- Higher Efficiency
- Reduction of Heat Sink Requirements
- Parallel Devices Without Thermal Runaway



Part Number	Package	Marking
F3C10170D	TO-247-2	C10170D

### Maximum Ratings ( $T_c = 25^\circ\text{C}$ unless otherwise specified)

Symbol	Parameter	Value	Unit	Test Conditions	Note
$V_{RRM}$	Repetitive Peak Reverse Voltage	1700	V		
$V_{RSM}$	Surge Peak Reverse Voltage	1700	V		
$V_{DC}$	DC Blocking Voltage	1700	V		
$I_F$	Continuous Forward Current	14.4	A	$T_c < 135^\circ\text{C}$	
$I_{FRM}$	Repetitive Peak Forward Surge Current	45 26	A	$T_c = 25^\circ\text{C}$ , $t_p = 10$ ms, Half Sine Wave, $D = 1$ $T_c = 110^\circ\text{C}$ , $t_p = 10$ ms, Half Sine Wave, $D = 1$	
$I_{FSM}$	Non-Repetitive Peak Forward Surge Current	55 41	A	$T_c = 25^\circ\text{C}$ , $t_p = 10$ ms, Half Sine Wave, $D = 1$ $T_c = 110^\circ\text{C}$ , $t_p = 10$ ms, Half Sine Wave, $D = 1$	
$P_{tot}$	Power Dissipation	231 100	W	$T_c = 25^\circ\text{C}$ $T_c = 110^\circ\text{C}$	
$T_c$	Maximum Case Temperature	135	$^\circ\text{C}$		
$T_j$	Operating Junction Range	-55 to +175	$^\circ\text{C}$		
$T_{stg}$	Storage Temperature Range	-55 to +135	$^\circ\text{C}$		
	TO-247 Mounting Torque	1 8.8	Nm lbf-in	M3 Screw 6-32 Screw	

**Electrical Characteristics**

Symbol	Parameter	Typ.	Max.	Unit	Test Conditions	Note
$V_F$	Forward Voltage	1.7 3	2 3.5	V	$I_F = 10\text{ A}$ $T_J = 25^\circ\text{C}$ $I_F = 10\text{ A}$ $T_J = 175^\circ\text{C}$	
$I_R$	Reverse Current	20 100	60 300	$\mu\text{A}$	$V_R = 1700\text{ V}$ $T_J = 25^\circ\text{C}$ $V_R = 1700\text{ V}$ $T_J = 175^\circ\text{C}$	
$Q_C$	Total Capacitive Charge	96		nC	$V_R = 1700\text{ V}$ , $I_F = 10\text{ A}$ $di/dt = 200\text{ A}/\mu\text{s}$ $T_J = 25^\circ\text{C}$	
C	Total Capacitance	827 78 41		pF	$V_R = 0\text{ V}$ , $T_J = 25^\circ\text{C}$ , $f = 1\text{ MHz}$ $V_R = 200\text{ V}$ , $T_J = 25^\circ\text{C}$ , $f = 1\text{ MHz}$ $V_R = 800\text{ V}$ , $T_J = 25^\circ\text{C}$ , $f = 1\text{ MHz}$	

Note:

1. This is a majority carrier diode, so there is no reverse recovery charge.

**Thermal Characteristics**

Symbol	Parameter	Typ.	Unit
$R_{\theta JC}$	Thermal Resistance from Junction to Case	0.65	$^\circ\text{C}/\text{W}$

**Typical Performance**

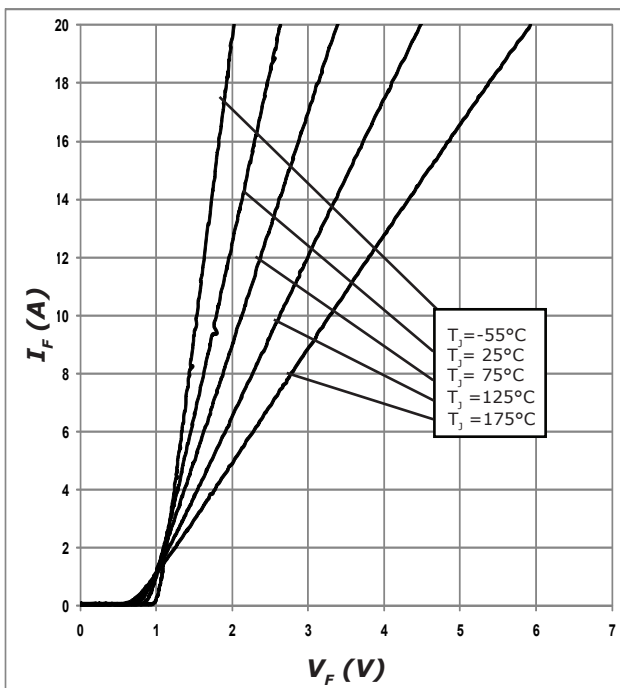

Figure 1. Forward Characteristics

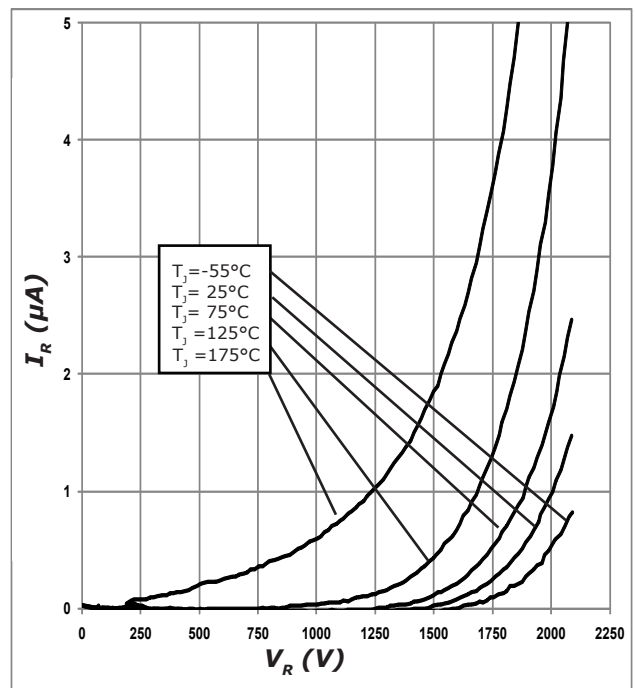

Figure 2. Reverse Characteristics

### Typical Performance

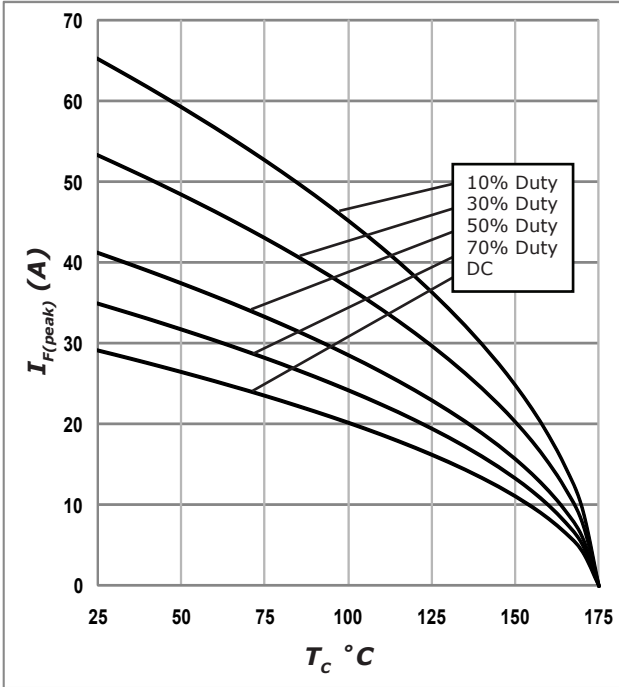

Figure 3. Current Derating

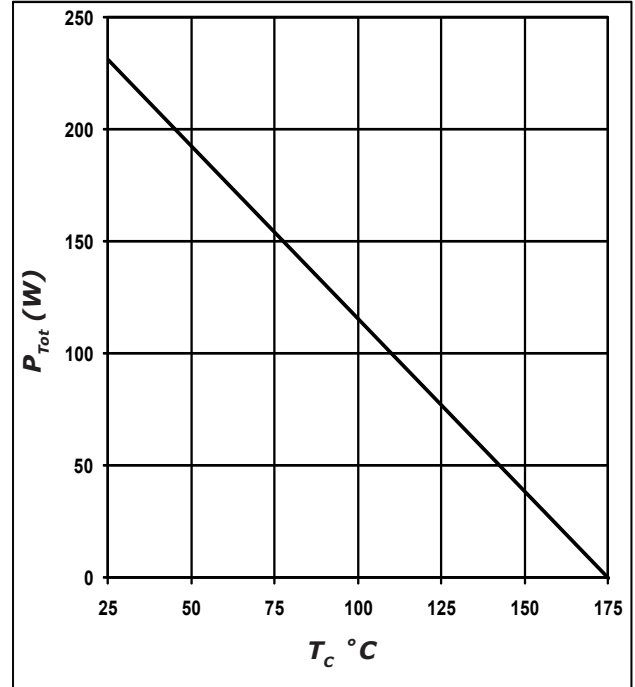

Figure 4. Power Derating

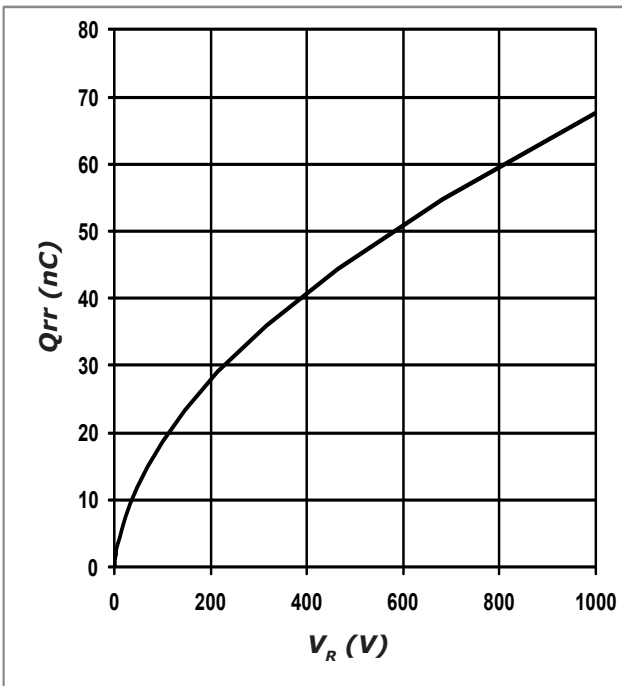

Figure 5. Recovery Charge vs. Reverse Voltage

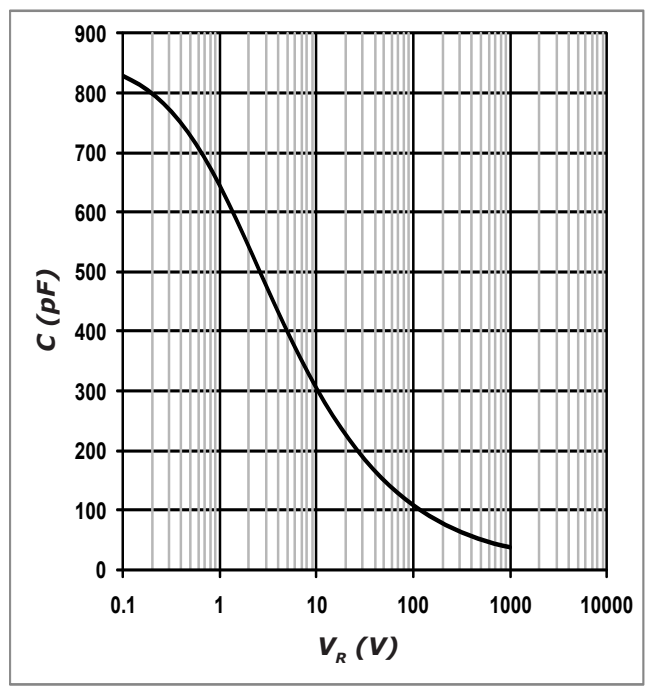
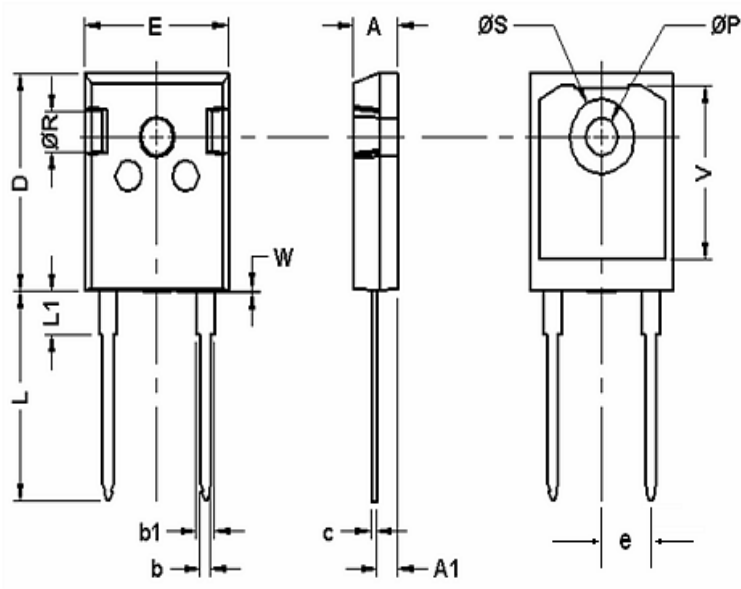

Figure 6. Capacitance vs. Reverse Voltage

### Package Dimensions

Package TO-247-2



POS	Inches		Millimeters	
	Min	Max	Min	Max
A	0.185	0.209	4.70	5.31
A1	0.087	0.102	2.21	2.59
b	0.040	0.055	1.02	1.40
b1	0.065	0.088	1.65	2.23
C	0.016	0.031	0.41	0.79
D	0.819	0.845	20.80	21.46
E	0.61	0.640	15.49	16.26
e	0.215	0.215	5.46	5.46
L	0.78	0.80	19.81	20.32
L1	0.164	0.176	4.17	4.47
øP	0.140	0.144	3.56	3.66
Q	0.212	0.244	5.38	6.20
øR	0.135	0.157	3.43	3.99
øS	0.278	0.288	7.06	7.32
V	0.652	0.662	16.56	16.81
W	0.000	0.006	0.00	0.15

