

# FQA46N15

## N-Channel QFET® MOSFET

150 V, 50 A, 42 mΩ

### Features

- 50 A, 150 V,  $R_{DS(on)} = 42 \text{ m}\Omega$  (Max) @  $V_{GS} = 10 \text{ V}$ ,  $I_D = 25 \text{ A}$
- Low Gate Charge (Typ. 85 nC)
- Low  $C_{rss}$  (Typ. 100 pF)
- 100% Avalanche Tested
- 175°C Maximum Junction Temperature Rating

### Description

This N-Channel enhancement mode power MOSFET is produced using Fairchild Semiconductor's proprietary planar stripe and DMOS technology. This advanced MOSFET technology has been especially tailored to reduce on-state resistance, and to provide superior switching performance and high avalanche energy strength. These devices are suitable for switched mode power supplies, audio amplifier, DC motor control, and variable switching power applications.

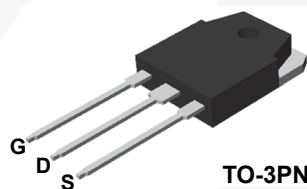

TO-3PN

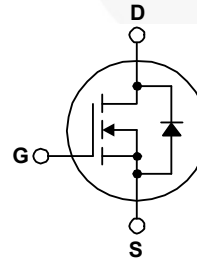

### Absolute Maximum Ratings $T_C = 25^\circ\text{C}$ unless otherwise noted.

Symbol	Parameter	FQA46N15	Unit
$V_{DSS}$	Drain-Source Voltage	150	V
$I_D$	Drain Current - Continuous ( $T_C = 25^\circ\text{C}$ )	50	A
	- Continuous ( $T_C = 100^\circ\text{C}$ )	35.3	A
$I_{DM}$	Drain Current - Pulsed (Note 1)	200	A
$V_{GSS}$	Gate-Source Voltage	$\pm 25$	V
$E_{AS}$	Single Pulsed Avalanche Energy (Note 2)	650	mJ
$I_{AR}$	Avalanche Current (Note 1)	50	A
$E_{AR}$	Repetitive Avalanche Energy (Note 1)	25	mJ
$dv/dt$	Peak Diode Recovery $dv/dt$ (Note 3)	6.0	V/ns
$P_D$	Power Dissipation ( $T_C = 25^\circ\text{C}$ )	250	W
	- Derate above $25^\circ\text{C}$	1.67	W/ $^\circ\text{C}$
$T_J, T_{STG}$	Operating and Storage Temperature Range	-55 to +175	$^\circ\text{C}$
$T_L$	Maximum Lead Temperature for Soldering, 1/8" from Case for 5 Seconds	300	$^\circ\text{C}$

### Thermal Characteristics

Symbol	Parameter	FQA46N15	Unit
$R_{\theta JC}$	Thermal Resistance, Junction-to-Case, Max.	0.6	$^\circ\text{C}/\text{W}$
$R_{\theta CS}$	Thermal Resistance, Case-to-Sink, Typ.	0.24	$^\circ\text{C}/\text{W}$
$R_{\theta JA}$	Thermal Resistance, Junction-to-Ambient, Max.	40	$^\circ\text{C}/\text{W}$

## Package Marking and Ordering Information

Part Number	Top Mark	Package	Packing Method	Reel Size	Tape Width	Quantity
FQA46N15	FQA46N15	TO-3PN	Tube	N/A	N/A	30 units

## Electrical Characteristics T<sub>C</sub> = 25°C unless otherwise noted.

Symbol	Parameter	Test Conditions	Min.	Typ.	Max.	Unit	
<b>Off Characteristics</b>							
BV <sub>DSS</sub>	Drain-Source Breakdown Voltage	V <sub>GS</sub> = 0 V, I <sub>D</sub> = 250 μA	150	--	--	V	
ΔBV <sub>DSS</sub> /ΔT <sub>J</sub>	Breakdown Voltage Temperature Coefficient	I <sub>D</sub> = 250 μA, Referenced to 25°C	--	0.16	--	V/°C	
I <sub>DSS</sub>	Zero Gate Voltage Drain Current	V <sub>DS</sub> = 150 V, V <sub>GS</sub> = 0 V	--	--	1	μA	
		V <sub>DS</sub> = 120 V, T <sub>C</sub> = 150°C	--	--	10	μA	
I <sub>GSSF</sub>	Gate-Body Leakage Current, Forward	V <sub>GS</sub> = 25 V, V <sub>DS</sub> = 0 V	--	--	100	nA	
I <sub>GSSR</sub>	Gate-Body Leakage Current, Reverse	V <sub>GS</sub> = -25 V, V <sub>DS</sub> = 0 V	--	--	-100	nA	
<b>On Characteristics</b>							
V <sub>GS(th)</sub>	Gate Threshold Voltage	V <sub>DS</sub> = V <sub>GS</sub> , I <sub>D</sub> = 250 μA	2.0	--	4.0	V	
R <sub>DS(on)</sub>	Static Drain-Source On-Resistance	V <sub>GS</sub> = 10 V, I <sub>D</sub> = 25A	--	0.033	0.042	Ω	
g <sub>FS</sub>	Forward Transconductance	V <sub>DS</sub> = 40 V, I <sub>D</sub> = 25A	--	36	--	S	
<b>Dynamic Characteristics</b>							
C <sub>iss</sub>	Input Capacitance	V <sub>DS</sub> = 25 V, V <sub>GS</sub> = 0 V, f = 1.0 MHz	--	2500	3250	pF	
C <sub>oss</sub>	Output Capacitance		--	520	670	pF	
C <sub>rss</sub>	Reverse Transfer Capacitance		--	100	130	pF	
<b>Switching Characteristics</b>							
t <sub>d(on)</sub>	Turn-On Delay Time	V <sub>DD</sub> = 75 V, I <sub>D</sub> = 45.6A, R <sub>G</sub> = 25 Ω	--	35	80	ns	
t <sub>r</sub>	Turn-On Rise Time		--	320	650	ns	
t <sub>d(off)</sub>	Turn-Off Delay Time		(Note 4)	--	210	430	ns
t <sub>f</sub>	Turn-Off Fall Time		(Note 4)	--	200	410	ns
Q <sub>g</sub>	Total Gate Charge	V <sub>DS</sub> = 120 V, I <sub>D</sub> = 45.6A, V <sub>GS</sub> = 10 V	--	85	110	nC	
Q <sub>gs</sub>	Gate-Source Charge		(Note 4)	--	15	--	nC
Q <sub>gd</sub>	Gate-Drain Charge		(Note 4)	--	41	--	nC
<b>Drain-Source Diode Characteristics and Maximum Ratings</b>							
I <sub>S</sub>	Maximum Continuous Drain-Source Diode Forward Current		--	--	50	A	
I <sub>SM</sub>	Maximum Pulsed Drain-Source Diode Forward Current		--	--	200	A	
V <sub>SD</sub>	Drain-Source Diode Forward Voltage	V <sub>GS</sub> = 0 V, I <sub>S</sub> = 50A	--	--	1.5	V	
t <sub>rr</sub>	Reverse Recovery Time	V <sub>GS</sub> = 0 V, I <sub>S</sub> = 45.6 A, dI <sub>F</sub> / dt = 100 A/μs	--	130	--	ns	
Q <sub>rr</sub>	Reverse Recovery Charge		--	0.55	--	μC	

### NOTES:

1. Repetitive rating: pulse-width limited by maximum junction temperature.
2. L = 0.43 mH, I<sub>AS</sub> = 50 A, V<sub>DD</sub> = 25 V, R<sub>G</sub> = 25 Ω, starting T<sub>J</sub> = 25°C.
3. I<sub>SD</sub> ≤ 46.6 A, di/dt ≤ 300 A/μs, V<sub>DD</sub> ≤ BV<sub>DSS</sub>, starting T<sub>J</sub> = 25°C.
4. Essentially independent of operating temperature typical characteristics.

## Typical Performance Characteristics

Figure 1. On-Region Characteristics

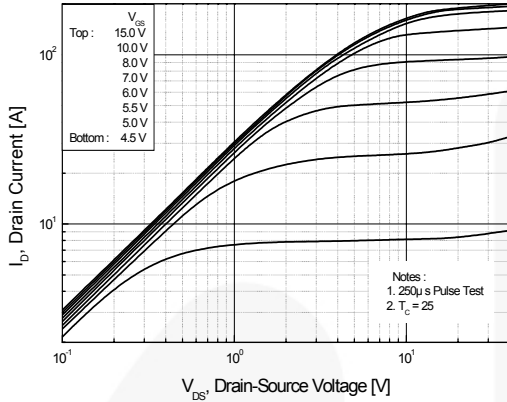

Figure 2. Transfer Characteristics

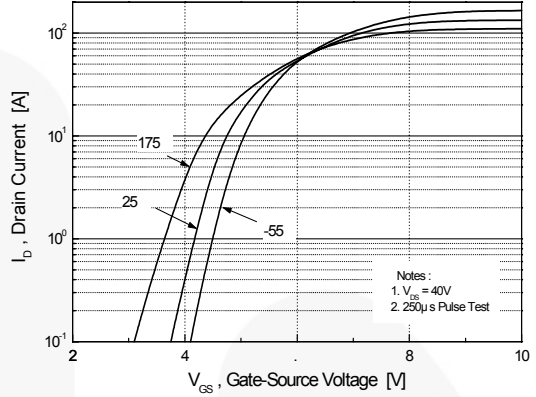

Figure 3. On-Resistance Variation vs. Drain Current and Gate Voltage

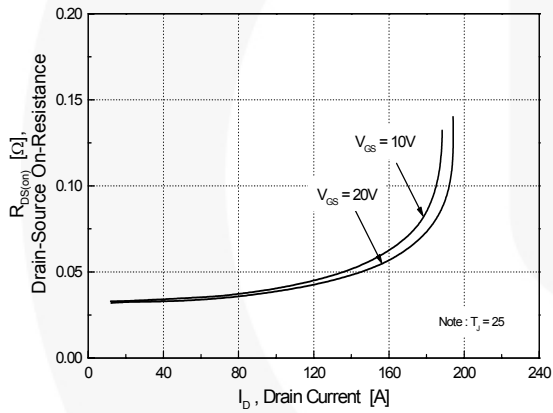

Figure 4. Body Diode Forward Voltage Variation vs. Source Current and Temperature

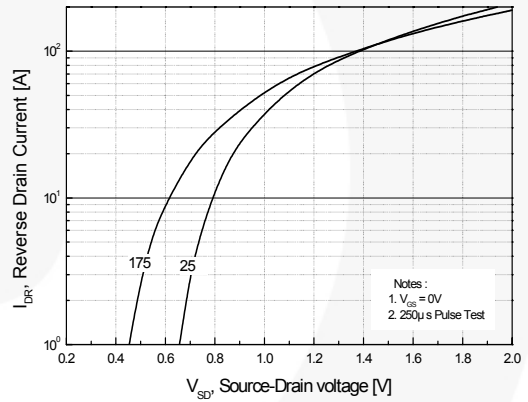

Figure 5. Capacitance Characteristics

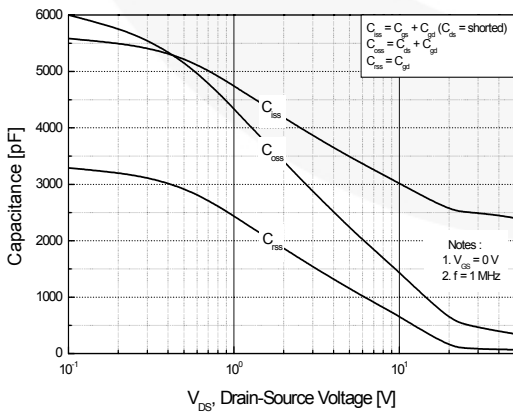
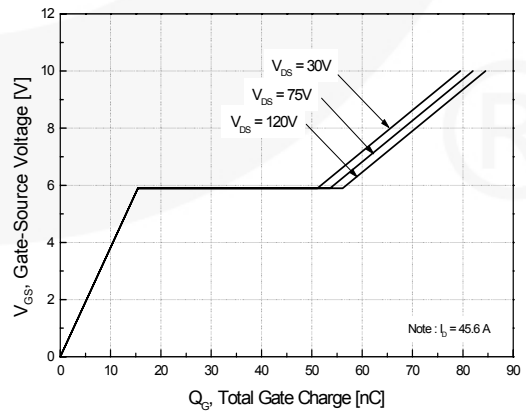
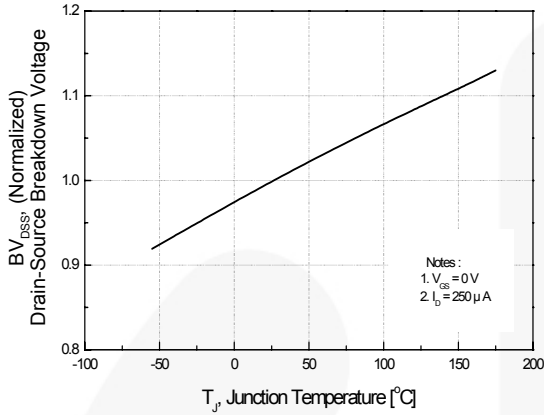

Figure 6. Gate Charge Characteristics



**Typical Performance Characteristics** (Continued)

**Figure 7. Breakdown Voltage Variation vs. Temperature**



**Figure 8. On-Resistance Variation vs. Temperature**

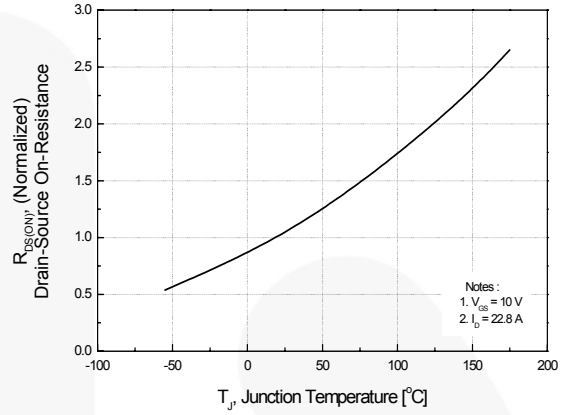

**Figure 9. Maximum Safe Operating Area**

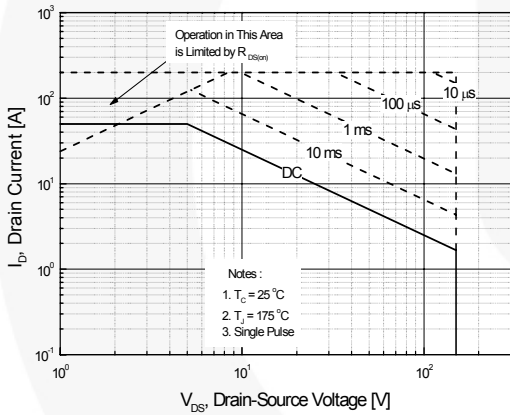

**Figure 10. Maximum Drain Current vs. Case Temperature**

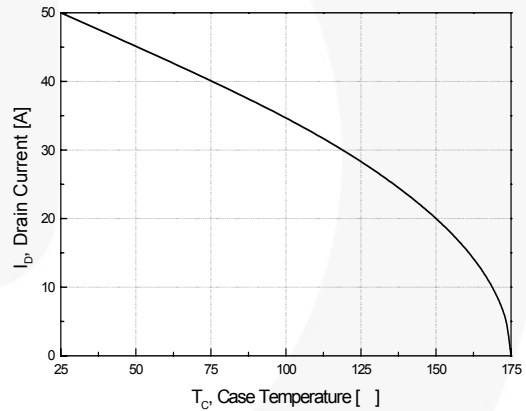

**Figure 11. Transient Thermal Response Curve**

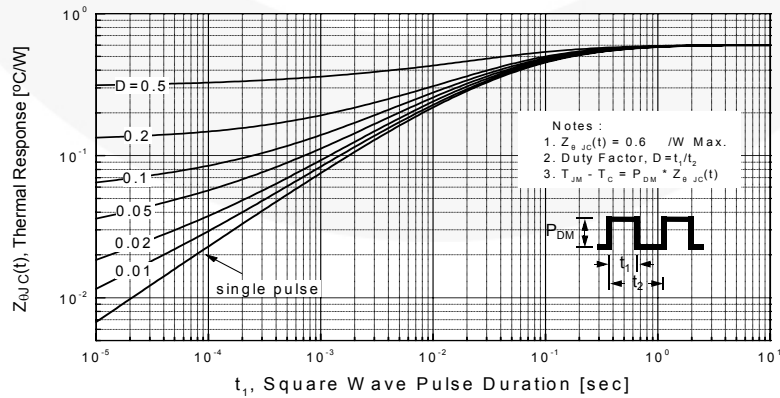

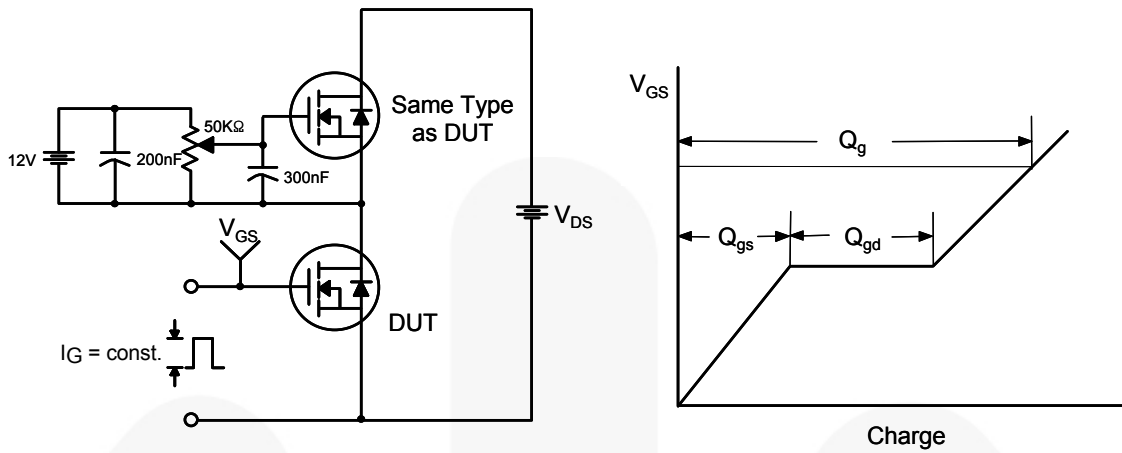

Figure 12. Gate Charge Test Circuit & Waveform

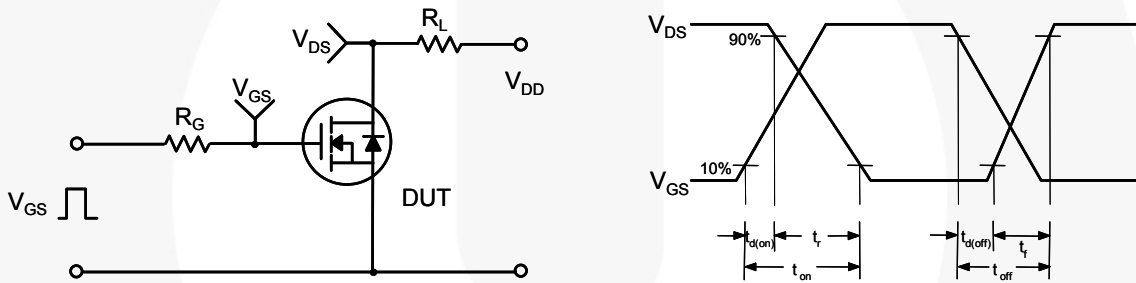

Figure 13. Resistive Switching Test Circuit & Waveforms

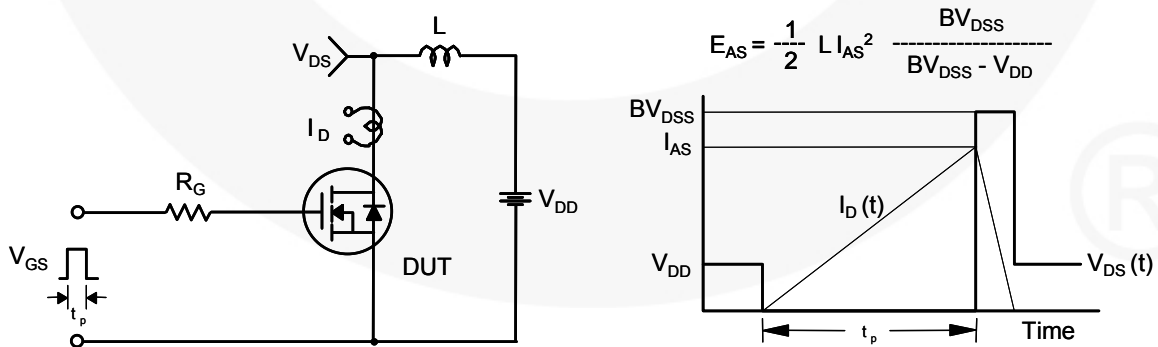

Figure 14. Unclamped Inductive Switching Test Circuit & Waveforms

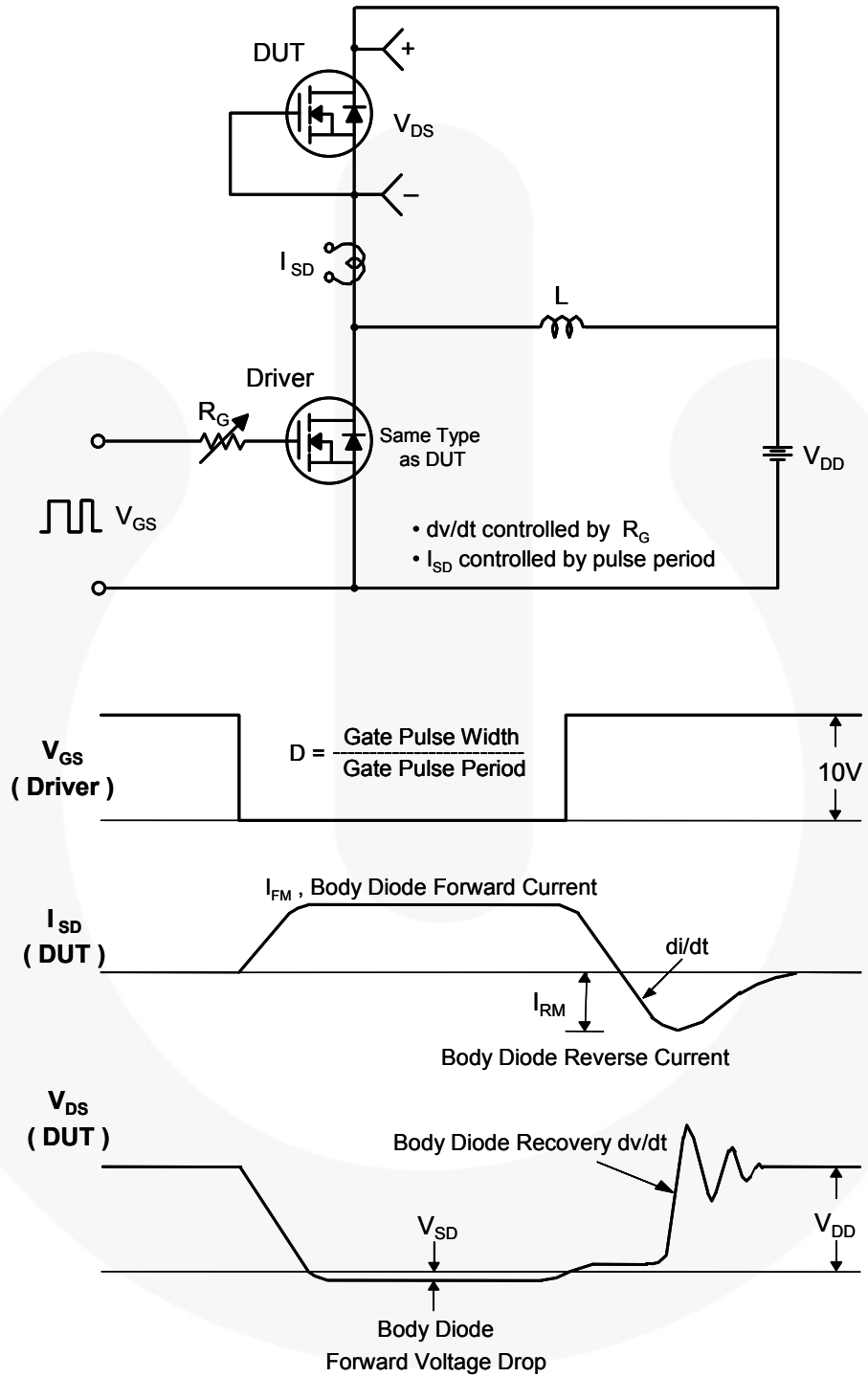
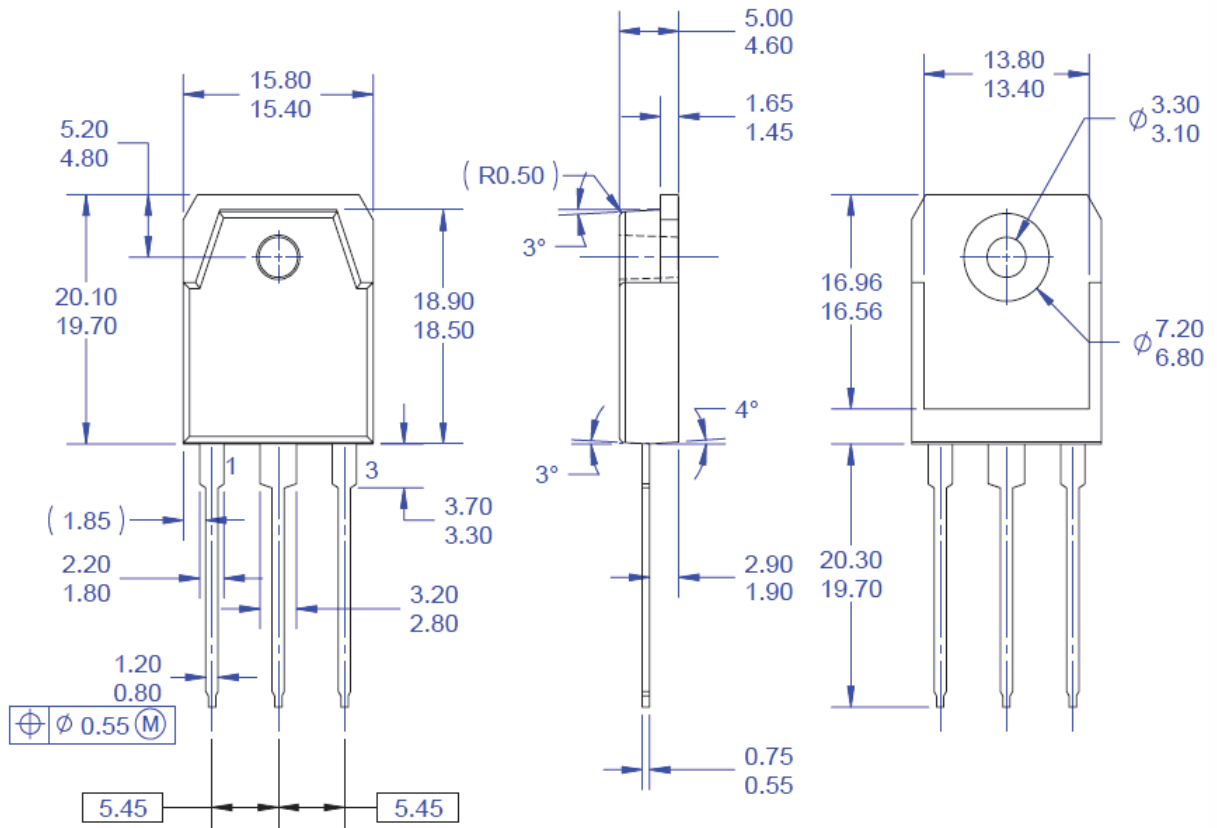

Figure 15. Peak Diode Recovery  $dv/dt$  Test Circuit & Waveforms

## Mechanical Dimensions



NOTES: UNLESS OTHERWISE SPECIFIED

- A) THIS PACKAGE CONFORMS TO EIAJ SC-65 PACKAGING STANDARD.
- B) ALL DIMENSIONS ARE IN MILLIMETERS.
- C) DIMENSION AND TOLERANCING PER ASME14.5
- D) DIMENSIONS ARE EXCLUSIVE OF BURRS, MOLD FLASH, AND TIE BAR EXTRUSIONS.
- E) THIS PACKAGE IS INTENDED ONLY FOR TO3PN.
- F) DRAWING FILE NAME: TO3P03AREV4.



**Figure 16. TO3, 3-Lead, Plastic, EIAJ SC-65**

Package drawings are provided as a service to customers considering Fairchild components. Drawings may change in any manner without notice. Please note the revision and/or date on the drawing and contact a Fairchild Semiconductor representative to verify or obtain the most recent revision. Package specifications do not expand the terms of Fairchild's worldwide terms and conditions, specifically the warranty therein, which covers Fairchild products.

Always visit Fairchild Semiconductor's online packaging area for the most recent package drawings:

[http://www.fairchildsemi.com/package/packageDetails.html?id=PN\\_TT3P0-003](http://www.fairchildsemi.com/package/packageDetails.html?id=PN_TT3P0-003)

