

## Vibra sense click

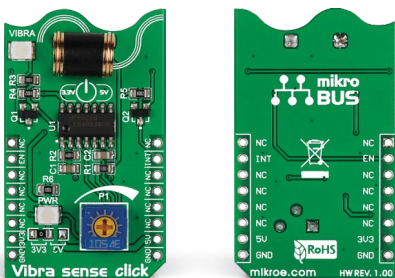

### 1. Introduction

Vibra Sense click is a **low cost micro shock vibration sensor** with a digital output which can be set as an Interrupt [mikroBUS™ INT pin] An onboard potentiometer lets you set the interrupt threshold. An onboard LED [marked VIBRA] gives visual indication. An additional Enable line [EN] is in place of the mikroBUS™ pin. The board is designed to use either a 3.3V and a 5V power supply.

### 2. Soldering the headers

Before using your click board™, make sure to solder 1x8 male headers to both left and right side of the board. Two 1x8 male headers are included with the board in the package.

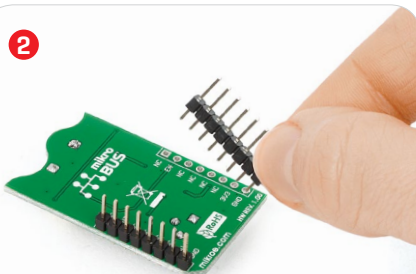
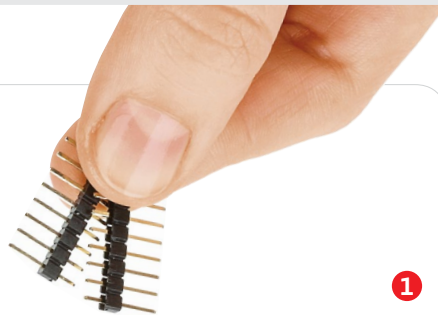

Turn the board upside down so that the bottom side is facing you upwards. Place shorter pins of the header into the appropriate soldering pads.

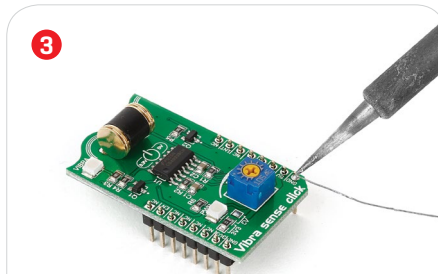

Turn the board upward again. Make sure to align the headers so that they are perpendicular to the board, then solder the pins carefully.

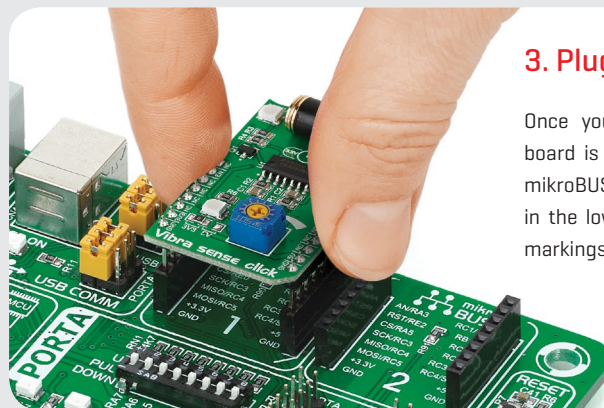

### 3. Plugging the board in

Once you have soldered the headers your board is ready to be placed into the desired mikroBUS™ socket. Make sure to align the cut in the lower-right part of the board with the markings on the silkscreen at the mikroBUS™ socket. If all the pins are aligned correctly, push the board all the way into the socket.

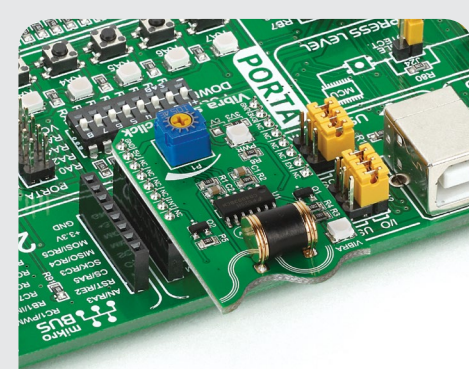

### 4. Essential features

Vibra sense click is a very simple and effective solution for detecting vibrations. The sensing unit consists of a round housing in which a spring is coiled around a metal pin. When exposed to vibration, the spring contacts the pin and closes the switch. Vibra sense click is a suitable solution for designers who are developing anti-tampering, anti-theft devices, especially if cost efficiency is among the primary requirements.

**click**  
BOARD™  
[www.mikroe.com](http://www.mikroe.com)



Vibra sense click Manual v100



0100000085899

## 5. Schematic

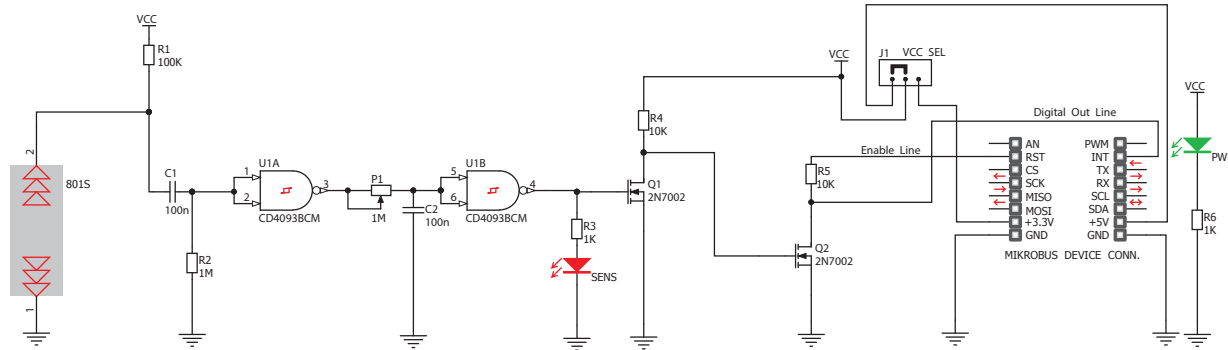

## 6. Dimensions

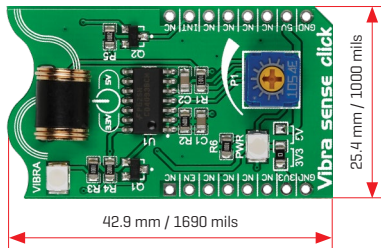

	mm	mils
LENGTH	42.9	1690
WIDTH	25.4	1000
HEIGHT*	3.9	154

\* without headers

## 7. SMD Jumper (zero ohm resistor)

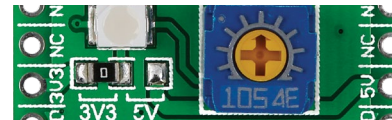

Vibra sense click features an SMD jumper [zero ohm resistor] that let's you switch between a 3.3V or a 5V power supply.

## 8. Code examples

Once you have done all the necessary preparations, it's time to get your click board™ up and running. We have provided examples for mikroC™, mikroBasic™ and mikroPascal™ compilers on our **Libstock** website. Just download them and you are ready to start.



## 9. Support

MikroElektronika offers **free tech support** [[www.mikroe.com/support](http://www.mikroe.com/support)] until the end of the product's lifetime, so if something goes wrong, we're ready and willing to help!



## 10. Disclaimer

MikroElektronika assumes no responsibility or liability for any errors or inaccuracies that may appear in the present document. Specification and information contained in the present schematic are subject to change at any time without notice.

Copyright © 2015 MikroElektronika.  
All rights reserved.

# Mouser Electronics

Authorized Distributor

Click to View Pricing, Inventory, Delivery & Lifecycle Information:

[Mikroe:](#)

[MIKROE-1927](#)