

BNC SERIES RF CO-AXIAL CONNECTORS

Overview

The BNC series are most widely used as 50Ω coaxial connectors, and compact size, light weight, and quick mounting and dismounting (bayonet lock coupling). Suitable for coaxial cables (RG-55.58/U) with a finished outside diameter of $\phi 3-\phi 8$.

Applicable standards

Defense Agency (NDS XC 6103, DSP C 6202)

Japanese Industrial Standards (JIS C 5412)

NTT (Model 2095 3C connector)

*Meets MIL Specifications. (See Products Meeting MIL Specifications Index Table, pages 220-221.)

Electrical Specifications

Item	Standard
Characteristic impedance	50Ω(*1)
Withstand voltage	1,500Vr.m.s. for 1min.
Insulation resistance	5,000MΩ or more at 500VDC
Contact resistance	3mΩ or less at 1ADC
Applicable frequency range	DC-4GHz
Voltage standing wave	1.2 or less(DC-2GHz)

(*1) Not different in electrical specifications from the 50Ω cable when connected to the 75Ω coaxial cable (3C-2V) for use at low frequencies (DC-200MHz).

Main Materials/Finish

Part	Material	Finish(*2)
Armor(shell)	Brass	Silver plated, Nickel-plated
Male terminal	Brass	Silver plated, Gold-plated
Female terminal	Beryllium copper	Silver plated, Gold-plated
Insulation	Tetraflouride resin	—
Gasket	Silicon rubber	—

(*2) Surface treatment differs according to the product number unit. For details, see the BNC Connector List.

BNC SERIES RF CO-AXIAL CONNECTORS

Plug

Applicable cable	Part No.	HRS No.	Dimension			Shape
			ϕD	ϕd	L	
RG-55/U, 58/U	UG-88/U(40)	302-0001-0-40	5.4	11.1	26.5	Fig.1
	UG-88D/U(40)	302-0070-3-40	5.6	12.7	28.8	Fig.1
	3CA-P2(40)	302-0203-5-40	5.6	13.7	29.5	Fig.1
RG-59/U, 62/U	UG-260/U(40)	302-0002-3-40	6.6	11.1	26.0	Fig.1
RG-188A/U	BNC-P-188A/U(40)	302-0216-7-40	3.0	8.0	25.0	Fig.4
RG-196A/U	BNC-P-196/U(40)	302-0214-1-40	2.3	5.0	27.3	Fig.6
5D-2W	BNC-P-5DW-1(40)	302-0189-6-40	8.5	14.0	35.0	Fig.3
5D-2W, 5C-2W	BNC-P-5DW-SA(40)	302-0217-0-40	8.7	15.0	33.7	Fig.2
5D-2V	BNC-P-5DV(40)	302-0132-9-40	7.8	15.0	31.0	Fig.1
5D-2V, 5C-2V	BNC-P-5DV-SA(40)	302-0218-2-40	8.0	15.0	33.7	Fig.2
3C-2Z	3CZ-P(40)	302-0215-4-40	6.5	13.7	29.5	Fig.1
3C-2T	3CT-P(40)	302-0210-0-40	8.0	14.2	29.7	Fig.1
	3CT-P-1(40)	302-0208-9-40	8.4	14.0	30.0	Fig.3
	3CT-P3(40)	302-0270-2-40	8.4	14.0	30.0	Fig.3
3C-2W	3DW-P(40)	302-0209-1-40	7.1	14.2	29.7	Fig.1
3D-2V, 3C-2V	BNC-P-3DV-SA(40)	302-0219-5-40	6.3	15.0	33.7	Fig.2
3C-2V	3CV-P2(40)	302-0202-2-40	6.3	13.7	29.5	Fig.1
	BNC-P-3(40)	302-0030-9-40	6.4	11.1	26.5	Fig.1
	3CV-P3(40)	302-0269-3-40	6.8	14.0	30.0	Fig.3
1.5D-2W, 1.5C-2W	BNC-P-1.5WCR(40)	302-0295-3-40	1.8	10.0	28.1	Fig.5
1.5D-2W	BNC-P-1.5W(40)	302-0299-4-40	3.9	8.0	25.0	Fig.4
1.5D-2V, 1.5C-2V	BNC-P-1.5CR(40)	302-0294-0-40	1.8	10.0	28.1	Fig.5
1.5D-2V	BNC-P-1.5(40)	302-0257-4-40	3.5	8.0	25.0	Fig.4

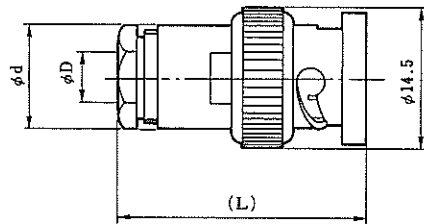

Fig.1

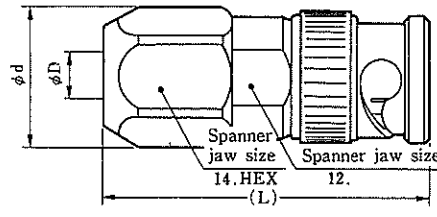

Fig.2

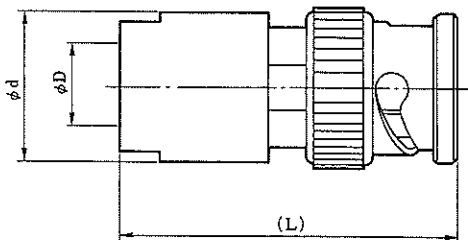

Fig.3

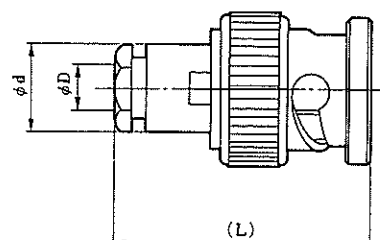

Fig.4

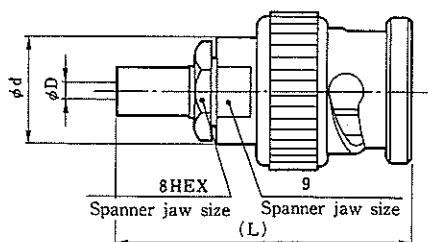

Fig.5

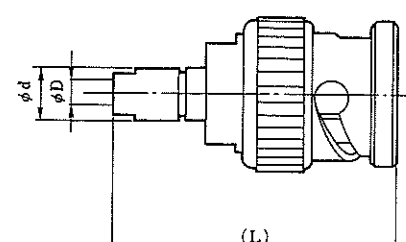

Fig.6

BNC SERIES RF CO-AXIAL CONNECTORS

L-shaped Plug

Applicable cable	Part No.	HRS No.	Dimension				Shape
			ϕD	ϕd	W1	W2	
BG-55/U, 58/U	UG-913/U(42)	302-0043-0-42	5.4	12.7	11.1	11.1	Fig.7
RG-59/U, 62/U	BNC-LP-59/U(40)	302-0075-7-40	6.6	12.7	11.1	11.1	Fig.7
3C-2W	3CW-PL(40)	302-0158-2-40	7.1	14.2	13.0	13.0	Fig.8
3C-2V	3CV-PL(40)	302-0157-0-40	6.3	13.7	12.0	12.0	Fig.8

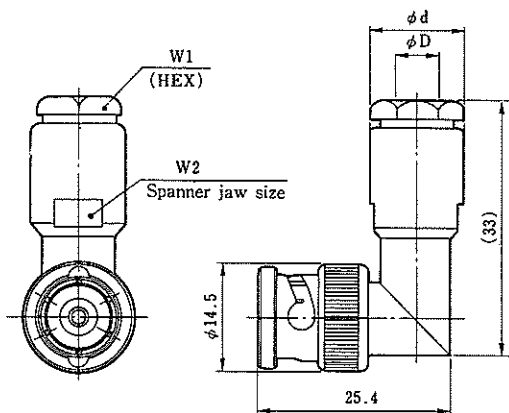

Fig.7

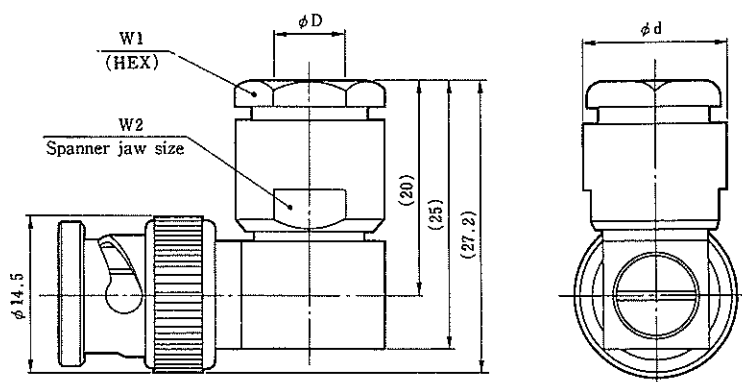

Fig.8

Jack

Applicable cable	Part No.	HRS No.	Dimension					Shape
			ϕD	ϕd	W1	W2	L	
RG-55/U, 58/U	UG-89/U(40)	302-0034-0-40	5.4	11.1	9.5	12.7	28.7	Fig.9
RG-59/U, 62/U	UG-261/U(40)	302-0035-2-40	6.6	11.1	9.5	12.7	30.0	Fig.9
3C-2V	3CV-J(40)	302-0006-4-40	6.3	11.1	9.5	11.5	28.7	Fig.9
1.5D-2W, 1.5C-2W	BNC-J-1.5WCR(40)	302-0297-9-40	1.8	—	8.0	13.0	31.0	Fig.10
1.5D-2V, 1.5C-2V	BNC-J-1.5CR(40)	302-0296-6-40	1.8	—	8.0	13.0	31.0	Fig.10

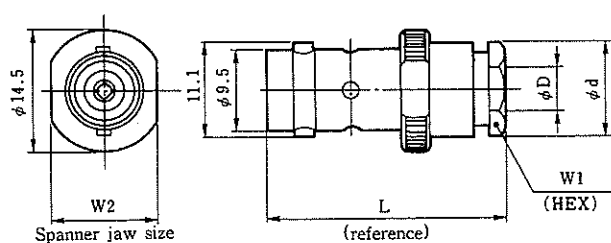

Fig.9

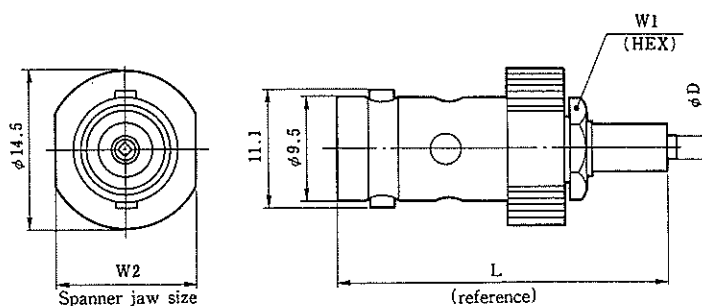

Fig.10

BNC SERIES RF CO-AXIAL CONNECTORS

Panel Jack

Applicable cable	Part No.	HRS No.	Dimension								Shape	Mounting hole dimensions
			ϕD	ϕd	L	ℓ	$\square P$	$\square S$	G	W		
RG-55/U, 58/U	UG-291/U(40)	302-0036-5-40	5.4	11.1	28.2	18.1	12.7	17.5	M2.6 $\times 0.45$	9.5	Fig.11	1-1
	3CA-PJ2(40)	302-0205-0-40	5.4	11.1	28.7	18.1	12.7	17.5	$\phi 3$	9.5	Fig.11	1-2
RG-59/U, 62/U	UG262/U(40)	302-0007-7-40	6.6	11.1	28.4	18.1	12.7	17.5	M2.6 $\times 0.45$	9.5	Fig.11	1-1
RG-188A/U	BNC-PJ-188/U(40)	302-0230-8-40	3.0	9.0	26.8	18.1	12.7	17.5	M2.6 $\times 0.45$	7.0	Fig.11	1-3
RG-196A/U	BNC-PJ-196/U(40)	302-0194-6-40	2.3	5.0	28.0	18.1	12.7	17.5	M2.6 $\times 0.45$	4.0	Fig.11	1-4
3C-2W	3CW-PJ(40)	302-0139-8-40	7.2	14.0	31.4	18.1	12.7	17.5	$\phi 3$	13.0	Fig.11	1-6
3C-2V	3CW-PJ2(40)	302-0204-8-40	6.3	11.1	28.7	18.1	12.7	17.5	$\phi 3$	9.5	Fig.11	1-2
2.5D-2V	BNC-PJ-1.5DV(40)	302-0238-0-40	4.7	11.1	28.7	18.1	12.7	17.5	$\phi 3$	9.5	Fig.11	1-2
1.5D-2W	BNC-PJ-1.5(40)	302-0228-6-40	4.5	9.5	26.8	18.1	12.7	17.5	M2.6 $\times 0.45$	7.0	Fig.11	1-7
	BNC-PJ-1.5W-1(40)	302-0260-9-40	4.5	9.5	26.8	20.1	12.7	17.5	$\phi 2.9$	7.0	Fig.11	1-8
	BNC-PJ-1.5W-2(40)	302-0282-1-40	4.5	9.5	26.8	20.1	12.7	17.5	M2.6 $\times 0.45$ $\phi 3$	7.0	Fig.11	1-9
1.5D-2V	BNC-PJ-1.5DV-1(40)	302-0285-0-40	3.4	9.5	26.8	18.1	12.7	17.5	$\phi 3$	7.0	Fig.11	1-8

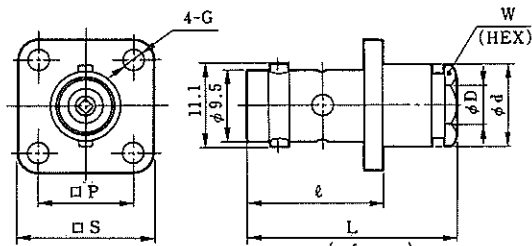

Fig. 11 (reference)

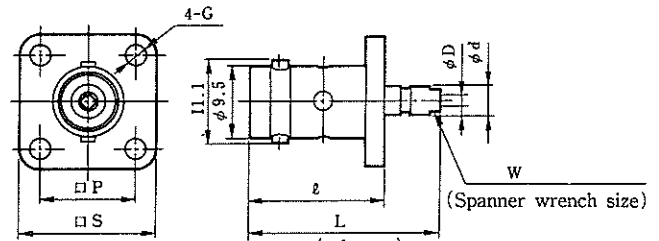

Fig. 12 (reference)

Applicable cable	Part No.	HRS No.	Dimension						Shape	Mounting hole dimensions
			ϕD	ϕd	L	ℓ	W1	W2		
RG-55/U, 58/U	BNC-PJ-58(40)	302-0108-4-40	5.4	1/2-28NEF-2A	28.5	16.9	9.5	17.0	Fig.13	4-1
1.5D-2W	BNC-BPJ-1.5W(40)	302-0284-7-40	4.5	3/8-32NEF-2A	26.8	12.8	7.0	11.0	Fig.15	3-3
	BNC-BPJ-1.5W-1(40)	302-0289-0-40	4.5	3/8-32NEF-2A	26.8	15.2	7.0	12.7	Fig.14	2-1
1.5D-2V	BNC-BPJ-1.5-1(40)	302-0252-0-40	3.5	3/8-32NEF-2A	26.8	15.2	7.0	12.7	Fig.14	2-1

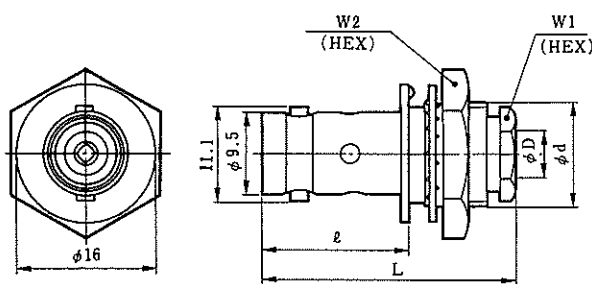

Fig. 13

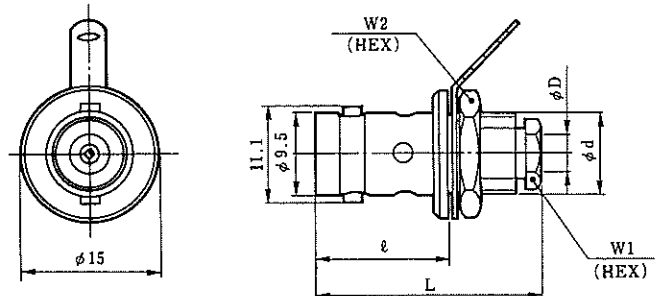

Fig. 14

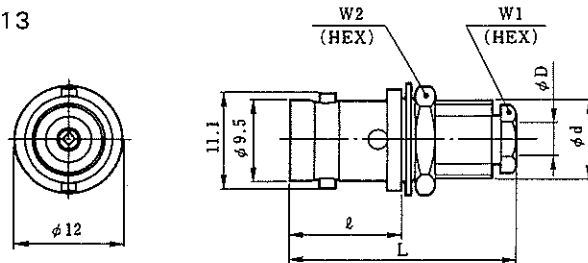

Fig. 15

BNC SERIES RF CO-AXIAL CONNECTORS

L-shaped Jack

Applicable cable	Part No.	HRS No.	Dimension							Mounting hole dimensions
			ϕD	ϕd	L	$\ell 1$	$\ell 2$	W1	W2	
1.5D-2V	BNC-LPJ-1.5(40)	302-0255-9-40	3.5	3/8-32NEF-2A	33.3	21.7	14.0	7.0	12.7	2-1

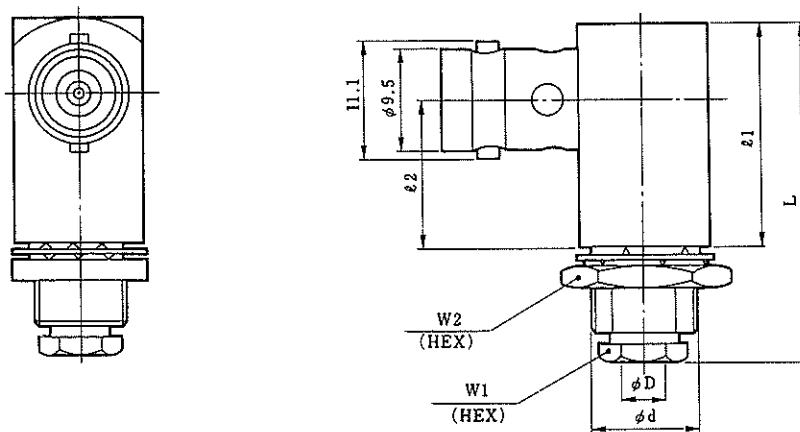
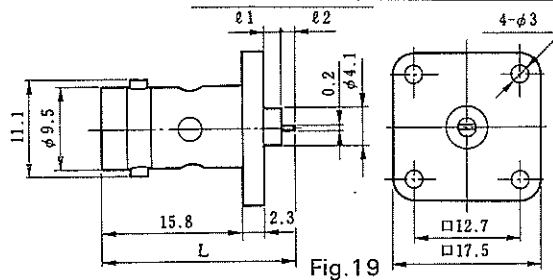
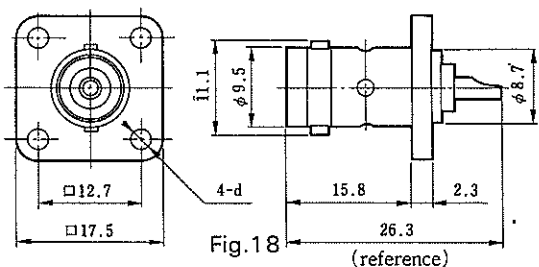

Fig.16

BNC SERIES RF CO-AXIAL CONNECTORS

Receptacles

Part No.	HRS No.	d	Mounting hole dimensions	Part No.	HRS No.	L	ℓ 1	ℓ 2	Remarks	Mounting hole dimensions
UG-290/U(40)	302-0009-2-40	M2.6X0.45	1-10	BNC-R-12(40)	302-0229-9-40	19.6	0	1.5	Tab terminal	1-12
3C-R(40)	302-0031-1-40	φ3	1-11	BNC-R-13(40)	302-0239-2-40	21.6	2.0	1.5	Tab terminal	1-12



Part No.	HRS No.	Remarks	Mounting hole dimensions
BNC-R-14(40)	302-0245-5-40	Round half cut terminal	1-12

Part No.	HRS No.	Remarks	Mounting hole dimensions
BNC-LR(40)	302-0020-5-40		1-11

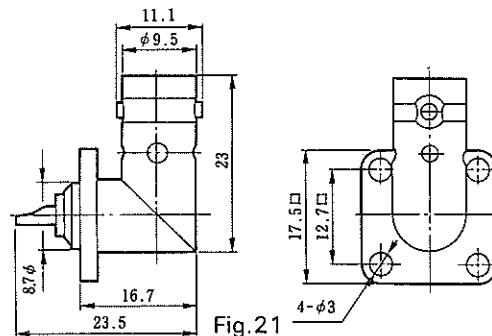
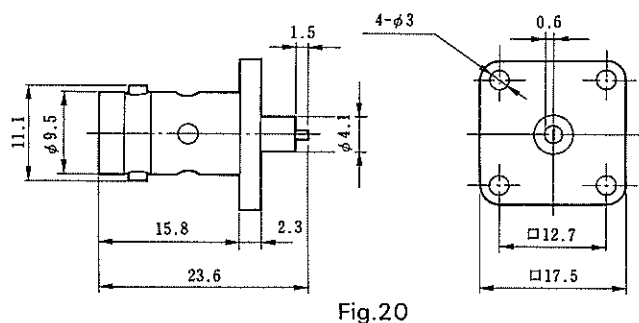

Part No.	HRS No.	φ D	L	ℓ	W	Panel mount type	Shape	Mounting hole dimensions
UG-604/U(40)	302-0016-8-40	14.5	26.3	13.7	12.7	2.8	Fig.25	3-1
UG-625/U(40)	302-0017-0-40	12.7	26.3	12.7	12.7	4	Fig.25	2-3
UG-625/U-4(40)	302-0221-7-40	12.7	26.3	12.7	12.7	4	Fig.23	2-3
UG-625/U-10(40)	302-0253-3-40	12.7	21.9	12.7	—	1.3	Fig.24	3-2
UG-625/U-11A(40)	302-0274-3-40	12.7	24.2	12.7	12.7	4	Fig.25	2-4
UG-657/U(40)	302-0012-7-40	14.5	32.6	15.2	12.7	5.6	Fig.25	3-3
UG-657/U-E(40)	302-0080-7-40	14.5	32.6	15.2	12.7	5.6	Fig.23	3-3
UG-1094/U(40)	302-0178-0-40	12.7	27.0	11.9	12.7	4	Fig.25	2-4

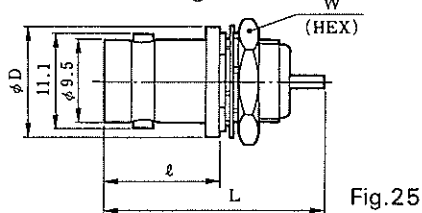
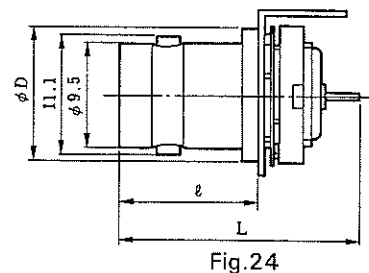
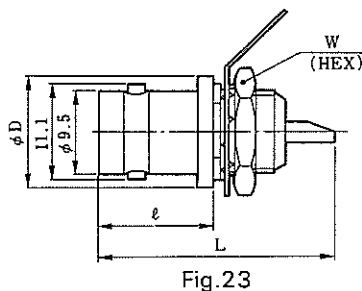
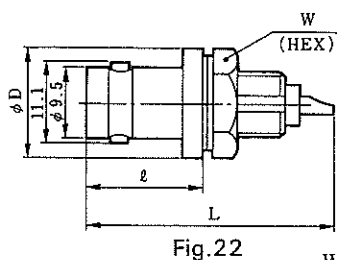

BNC SERIES RF CO-AXIAL CONNECTORS

Part No.	HRS No.	Shape	Mounting hole dimensions
BNC-FBR(41)	302-0268-0-41	Fig.27	2.3
BNC-FBR-W(40)	302-0279-7-40	Fig.29	—

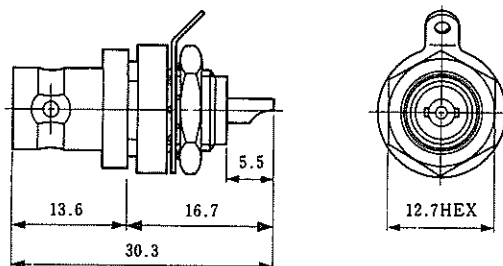

Outside-insulating connector Fig.27

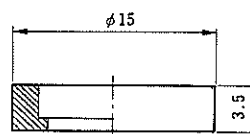

Fig.29

Washer mounted on BNC-FBR(01), shown in Fig.28, to connect the panel to the connector external conductor.

Plug receptacles

Part No.	HRS No.	Mounting hole dimensions
BNC-BPR-3(40)	302-0249-6-40	2-1

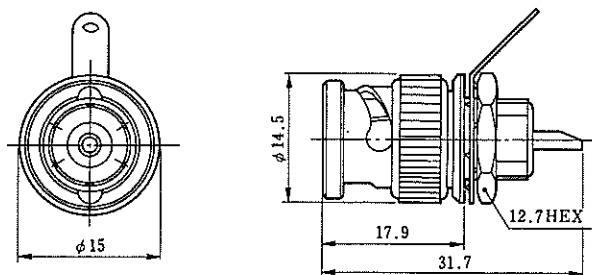

Fig.30

BNC SERIES RF CO-AXIAL CONNECTORS

Printed-circuit-board mounting type

Part No.	HRS No.	Shape	L	ℓ 1	ℓ 2	Mounting hole dimensions
BNC-R-PC(40)	302-0241-4-40	Fig.31	23.1	18.1	5.0	6-1
BNC-R-PC-2(40)	302-0243-0-40	Fig.32	20.4	17.1	3.3	7-2
BNC-R-PC-7(40)	302-0280-6-40	Fig.31	23.1	20.64	2.46	6-1

Part No.	HRS No.	Shape	Mounting hole dimensions
BNC-LR-PC(40)	302-0242-7-40	Fig.33	6-1
BNC-LR-PC-1(40)	302-0262-4-40	Fig.34	7-1
BNC-LR-PC-3(40)	302-0276-9-40	Fig.35	6-1

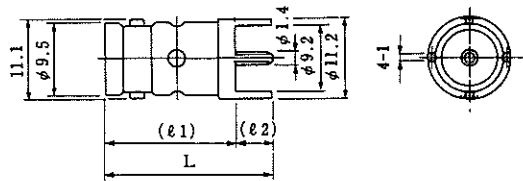

Fig.31

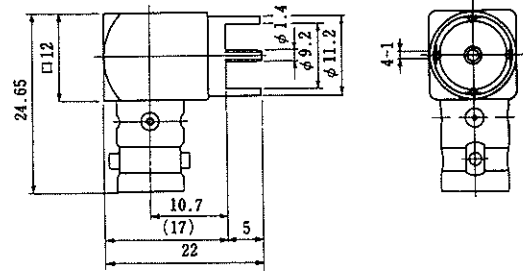

Fig.33

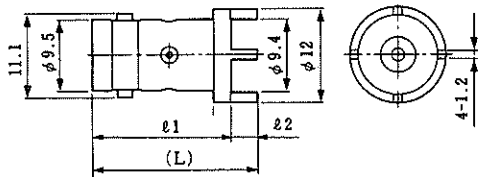

Fig.32

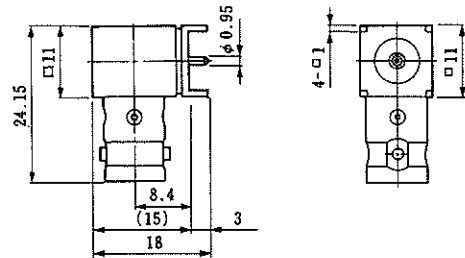

Fig.34

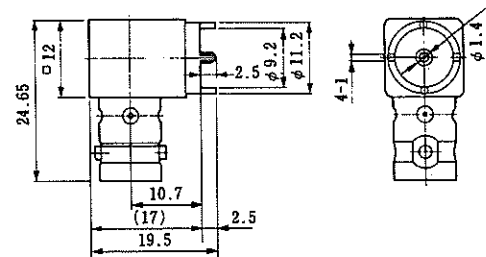

Fig.35

Dec.1.2018 Copyright 2018 HIROSE ELECTRIC CO., LTD. All Rights Reserved.

Lug terminal

Part No.	HRS No.	Remarks
BNC-EL	302-0079-8	Earth Lug

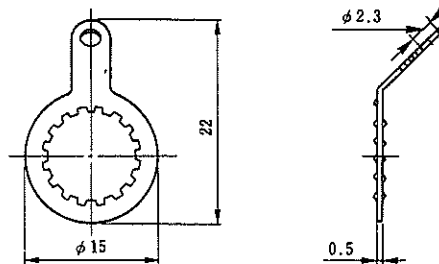

Fig.36

BNC SERIES RF CO-AXIAL CONNECTORS

Adapters

Part No.	HRS No.	Shape
BNC-A-JJ(40)	302-0039-3-40	Fig.37
BNC-A-JJ-1(40)	302-0050-6-40	Fig.38

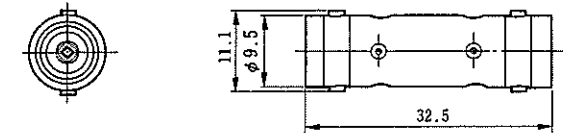

Fig. 37

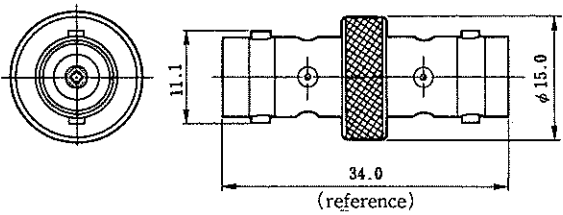

Fig. 38

Part No.	HRS No.	L	ℓ	d	Shape
BNC-PA-JJ(40)	302-0052-1-40	34	15.85	φ3	Fig.39
UG-414/U(40)	302-0040-2-40	32.54	17.6	M2.6X0.45	Fig.39

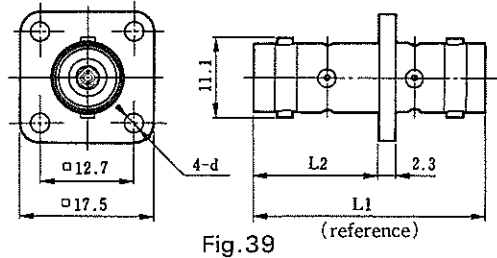

Fig. 39

Part No.	HRS No.	Remarks
UG-491/U(40)	302-0022-0-40	A-PP

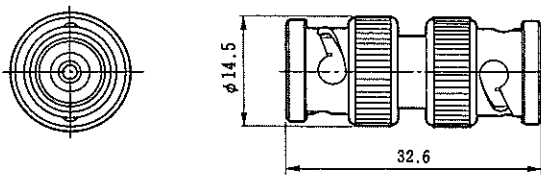

Fig. 40

Part No.	HRS No.	Remarks
UG-306/U(40)	302-0023-3-40	LA-PJ

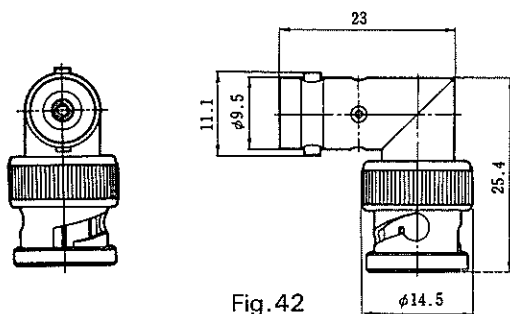

Fig. 42

Part No.	HRS No.	Remarks
BNC-TA-JJJ(40)	302-0024-6-40	

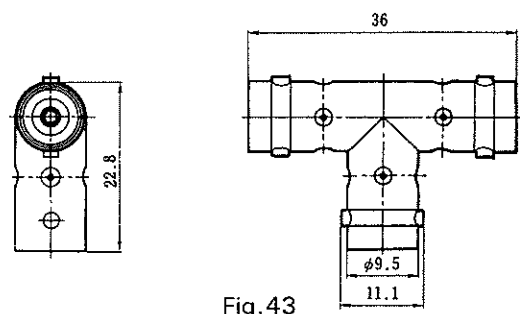

Fig. 43

Part No.	HRS No.	Remarks
UG-274/U(40)	302-0025-9-40	TA-JPJ

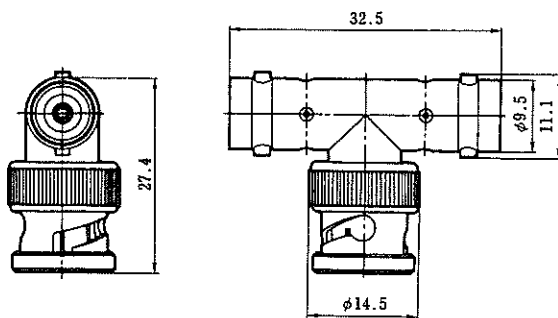

Fig. 44

Part No.	HRS No.	L	Remarks
BNC-UPA(40)	302-0167-3-40	35	U Link

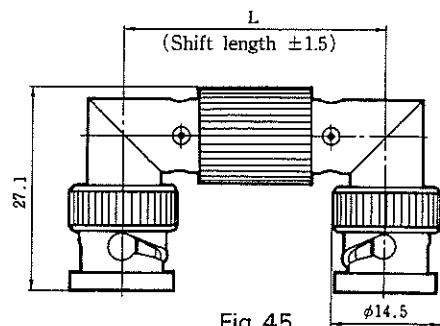

Fig. 45

BNC SERIES RF CO-AXIAL CONNECTORS

Cap

Short plug

Part No.	HRS No.	Remarks
CW-123A/U(40)	302-0041-5-40	—

Part No.	HRS No.	Remarks
JCW-159/U(40)	302-0026-1-40	Short Plug

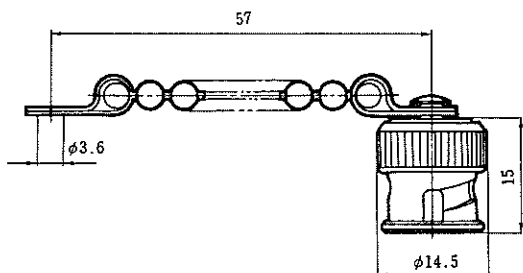

Fig.46

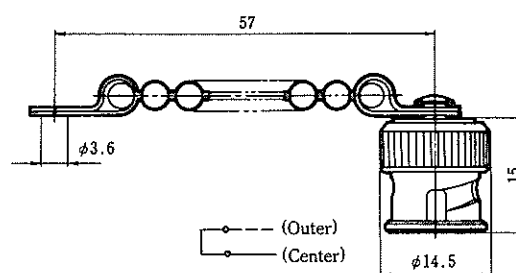

Fig.47

BNC SERIES RF CO-AXIAL CONNECTORS

Model BNC Connector List

Type	Part No.	HRS No.	Applicable cable	Surface treatment				Remarks
				Armor		Center contact		
				Silver	Nickel	Silver	Gold	
Straight plug	UG-88/U(40)	302-0001-0-40	RG-55/U, 58/U	○		○		
	UG-88D/U(40)	302-0070-3-40		○		○		
	3CA-P2(40)	302-0203-5-40		○		○		
	UG-260/U(40)	302-0002-3-40	RG-59/U, 62/U	○		○		
	BNC-P-188A/U(40)	302-0216-7-40	RG-188A/U	○		○		
	BNC-P-196/U(40)	302-0214-1-40	RG-196A/U	○			○	
	BNC-P-5DV-SA(40)	302-0218-2-40	5D-2V, 5C-2V	○		○		
	BNC-P-5DW-1(40)	302-0189-6-40	5D-2W	○		○		
	BNC-P-5DW-SA(40)	302-0217-0-40	5D-2W, 5C-2W	○		○		
	BNC-P-3(40)	302-0030-9-40	3C-2V	○		○		
	BNC-P-3DV-SA(40)	302-0219-5-40	3D-2V, 3C-2V	○		○		
	3CV-P2(40)	302-0202-2-40	3C-2V	○		○		
	3CV-P3(40)	302-0269-3-40		○		○		
	BNC-P-1.5WCR(40)	302-0295-3-40	1.5D-2W, 1.5C-2W		○	○		
	BNC-P-1.5(40)	302-0257-4-40	1.5D-2V		○	○		
	BNC-P-1.5W(40)	302-0299-4-40	1.5D-2W		○	○		
	BNC-P-1.5CR(40)	302-0294-0-40	1.5D-2V, 1.5C-2V		○	○		
	3CZ-P(40)	302-0215-4-40	3C-2Z	○		○		
	3CT-P(40)	302-0210-0-40	3C-2T	○		○		
	3CT-P-1(40)	302-0208-9-40		○		○		
3CT-P3(40)	302-0270-2-40	○			○			
3CW-P(40)	302-0209-1-40	3C-2W	○		○			

BNC SERIES RF CO-AXIAL CONNECTORS

Type	Part No.	HRS No.	Applicable cable	Surface treatment				Remarks
				Armor		Center contact		
				Silver	Nickel	Silver	Gold	
L-shaped plug	UG-913/U(42)	302-0043-0-42	RG-55/U, 58/U	○		○		
	BNC-LP-59/U(40)	302-0075-7-40	RG-59/U, 62/U	○		○		
	3CV-PL(40)	302-0157-0-40	3C-2V	○		○		
	3CW-PL(40)	302-0158-2-40	3C-2W	○		○		
Jack	UG-89/U(40)	302-0034-0-40	RG-55/U, 58/U	○		○		
	UG-261/U(40)	302-0035-2-40	RG59/U, 62/U	○		○		
	3CV-J(40)	302-0006-4-40	3C-2V	○		○		
	BNC-J-1.5WCR(40)	302-0297-9-40	1.5D-2W, 1.5C-2W		○	○		
	BNC-J-1.5CR(40)	302-0296-6-40	1.5D-2V, 1.5C-2V		○	○		
Panel Jack	UG-291/U(40)	302-0036-5-40	RG-55/U, 58/U	○		○		
	3CA-PJ2(40)	302-0205-0-40	RG-58/U, 58/U	○		○		
	UG-262/U(40)	302-0007-7-40	RG-59/U, 62/U	○		○		
	BNC-PJ-58(40)	302-0108-4-40	RG-55/U, 58/U	○		○		
	BNC-PJ-188/U(40)	302-0230-8-40	RG-188A/U		○	○		
	BNC-PJ-196/U(40)	302-0194-6-40	RG-196A/U	○			○	
	3CW-PJ(40)	302-0139-8-40	3C-2W	○		○		
	BNC-PJ-2.5DV(40)	302-0238-0-40	2.5D-2V	○		○		
	BNC-PJ-1.5(40)	302-0228-6-40	1.5D-2W		○	○		
	BNC-PJ-1.5W-1(40)	302-0260-9-40			○	○		
	BNC-PJ-1.5W-2(40)	302-0282-1-40			○	○		
	BNC-BPJ-1.5W(40)	302-0284-7-40			○	○		
	BNC-BPJ-1.5W-1(40)	302-0289-0-40			○	○		
	BNC-BPJ-1.5DW(40)	302-0400-6-40			○		○	
					○		○	

Dec.1.2018 Copyright 2018 HIROSE ELECTRIC CO., LTD. All Rights Reserved.

BNC SERIES RF CO-AXIAL CONNECTORS

Type	Part No.	HRS No.	Applicable cable	Surface treatment				Remarks	
				Armor		Center contact			
				Silver	Nickel	Silver	Gold		
Panel jack	BNC-PJ-1.5DV-1(40)	302-0285-0-40	1.5D-2V		○	○			
	BNC-BPJ-1.5-1(40)	302-0252-0-40			○		○		
	BNC-BPJ-1.5DV(40)	302-0393-2-40			○				
	3CV-PJ2(40)	302-0204-8-40	3C-2V	○		○			
L-shaped Panel jack	BNC-LPJ-1.5(40)	302-0255-9-40	1.5D-2V		○	○			
Receptacle	Flange type	U-290/U(40)	302-0009-2-40	4-M2.6X0.45	○		○		
		3C-R(40)	302-0031-1-40	4-φ3	○		○		
		BNC-R-12(40)	302-0229-9-40			○		○	
		BNC-R-13(40)	302-0239-2-40			○		○	
		BNC-R-14(40)	302-0245-5-40			○	○		
	Bulk head type	UG-604/U(40)	302-0016-8-40		○		○		
		UG-625/U(40)	302-0017-0-40		○		○		
		UG-625/U-4(40)	302-0221-7-40			○	○		
		UG-625/U-10(40)	302-0253-3-40	Folk terminal		○	○		
		UG-625/U-11A(40)	302-0274-3-40			○	○		
		UG-657/U(40)	302-0012-7-40	drip-proof type	○		○		
		UG-657/U-E(40)	302-0080-7-40	drip-proof type	○		○		

BNC SERIES RF CO-AXIAL CONNECTORS

Type	Part No.	HRS No.	Applicable cable	Surface treatment				Remarks	
				Armor		Center contact			
				Silver	Nickel	Silver	Gold		
Receptacle	Bulk head type	UG-1094/U(40)	302-0178-0-40		○		○		
		BNC-FBR(41)	302-0268-0-41	Insulation type PPO		○	○		
		BNC-FBR-W(40)	302-0279-7-40	Metal washer for BNC-FBR		○			
	L-shaped type	Plug type	BNC-LR(40)	302-0020-5-40		○		○	
			BNC-BPR-3(40)	302-0249-6-40			○		○
	Straight type for PCB	BNC-R-PC(40)	302-0241-4-40			○	○		
		BNC-R-PC-2(40)	302-0243-0-40			○	○		
		BNC-R-PC-7(40)	302-0280-6-40			○	○		
	L-shaped type for PCB	BNC-LR-PC(40)	302-0242-7-40			○	○		
		BNC-LR-PC-1(40)	302-0262-4-40			○	○		
		BNC-LR-PC-3(40)	302-0276-9-40			○	○		
	Ground lug plate	BNC-EL	302-0079-8		○				

BNC SERIES RF CO-AXIAL CONNECTORS

Type	Part No.	HRS No.	Applicable cable	Surface treatment				Remarks
				Armor		Center contact		
				Silver	Nickel	Silver	Gold	
Adaoter	BNC-A-JJ(40)	302-0039-3-40		○		○		
	BNC-A-JJ-1(40)	302-0050-6-40		○		○		
	BNC-PA-JJ(40)	302-0052-1-40		○		○		
	UG-414/U(40)	302-0040-2-40	PA-JJ type	○		○		
	UG-491/U(40)	302-0022-0-40	A-PP type	○		○		
L-shaped adapter	UG-306/U(40)	302-0023-3-40	LA-PJ type	○		○		
T-shaped adapter	BNC-TA-JJJ(40)	302-0024-6-40		○		○		
	UG-274/U(40)	302-0025-9-40	(TA-JP type)	○		○		
U ring	BNC-UPA(40)	302-0167-3-40	35-mm movable	○		○		
Cap	CW-123A/U(40)	302-0041-5-40	For jack	○		○		
Plug shot	JCW-159/U(40)	302-0026-1-40		○		○		

BNC SERIES RF CO-AXIAL CONNECTORS

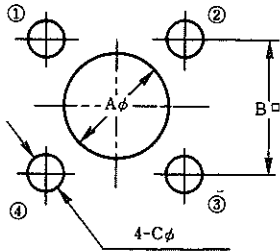

Fig. 1

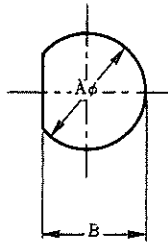

Fig. 2

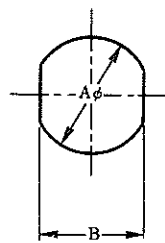

Fig. 3

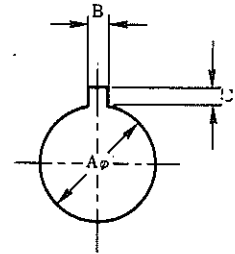

Fig. 4

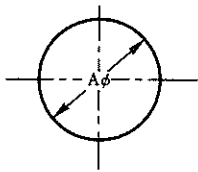

Fig. 5

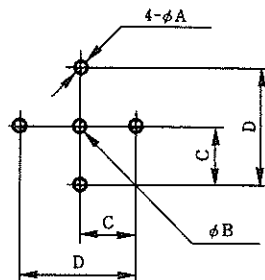

Fig. 6

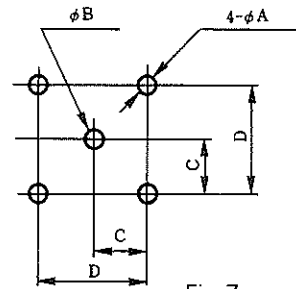

Fig. 7

Fig.	No.	A	B	C	D
1	1-1	11.4	12.7	3	—
	1-2	11.4	12.7	3.2	—
	1-3	9.8	12.7	3	—
	1-4	5.3	12.7	3	—
	1-5	12.3	12.7	3.2	—
	1-6	14.3	12.7	3.2	—
	1-7	9.8	12.7	3	—
	1-8	9.8	12.7	3.2	—
	1-9	9.8	12.7	$\frac{1-3}{3}$ $\frac{2-4}{3.2}$	—
	1-10	9	12.7	3	—
	1-11	9	12.7	3.2	—
	1-12	4.3	12.7	3.2	—
	1-13	15	18.2	3.4	—
	1-14	7	12.7	3	—

Fig.	No.	A	B	C	D
2	2-1	$9.6^{+0.1}_0$	$9^{+0.1}_0$	—	—
	2-2	$9.6^{+0.1}_0$	$8.5^{+0.1}_0$	—	—
	2-3	$11.3^{+0.1}_0$	$10.3^{+0.1}_0$	—	—
	2-4	$9.6^{+0.1}_0$	$8.8^{+0.1}_0$	—	—
	2-5	$12.1^{+0.1}_0$	$11.1^{+0.1}_0$	—	—
3	3-1	$9.6^{+0.1}_0$	$8.1^{+0.1}_0$	—	—
	3-2	$9.6^{+0.1}_0$	$8.3^{+0.1}_0$	—	—
	3-3	$9.6^{+0.1}_0$	$8.6^{+0.1}_0$	—	—
4	4-1	$12.7^{+0.1}_0$	$1.3^{+0.1}_0$	$1.8^{+0.1}_0$	—
5	5-1	$12.7^{+0.1}_0$	—	—	—
6	6-1	$1.6^{+0.1}_0$	$1.6^{+0.1}_0$	5.08 ± 0.05	10.16 ± 0.05
7	7-1	$1.8^{+0.1}_0$	$1.8^{+0.1}_0$	5.08 ± 0.05	10.16 ± 0.05
	7-2	$1^{+0.1}_0$	$1.4^{+0.1}_0$	3.81 ± 0.05	7.62 ± 0.05

BNC SERIES RF CO-AXIAL CONNECTORS

Functional drawing

Typical part numbers are enclosed in parentheses

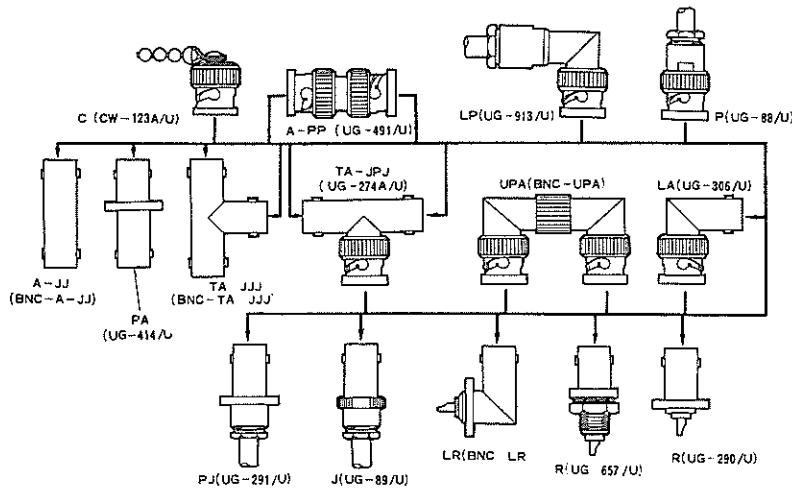
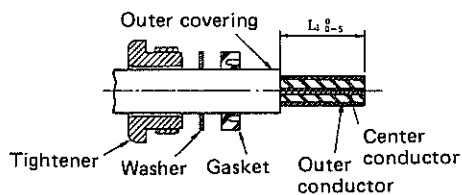

Table 1. End processing dimensions arranged by part number

(Unit : mm)

HRS No.	Part No.	$L_1 \pm 0.5$	$L_2 \pm 0.1$	L_3
CL302-0001-0-40	UG-88/U(40)	7.5	3	2.9
CL302-0002-3-40	UG-260/U(40)	7.6	3	2.9
CL302-0006-4-40	3CV-J(40)	7.4	3	3.2
CL302-0007-7-40	UG-262/U(40)	7.3	3	2.9
CL302-0034-0-40	UG-89/U(40)	7.5	3	2.9
CL302-0035-2-40	UG-261/U(40)	7.3	3	2.9
CL302-0036-5-40	UG-291/U(40)	7.5	3	2.9
CL302-0043-0-42	UG-913/U(42)	7.4	3	2.4
CL302-0070-3-40	UG-88D/U(40)	7.6	3	2.7
CL302-0129-4-40	3DW-P2(40)	10	3	5
CL302-0132-9-40	BNC-P-5DV(40)	11.4	2.5	5
CL302-0152-6-40	3CF-P(40)	10	3	5
CL302-0157-0-40	3CV-PL(40)	9.4	1.8	5.3
CL302-0202-2-40	3CV-P2(40)	9.6	3	5
CL302-0203-5-40	3CA-P2(40)	9.6	3	5
CL302-0204-8-40	3CV-PJ2(40)	7	3	2.8
CL302-0205-0-40	3CA-PJ2(40)	7	3	2.8
CL302-0209-1-40	3CW-P(40)	10.4	3	5
CL302-0210-0-40	3CT-P(40)	10.9	3	5

Connecting methods



The ends are processed as shown in the drawing (refer to Table 1). For the end processing dimensions L_1 , refer to Table 1, End processing dimensions arranged by part number.

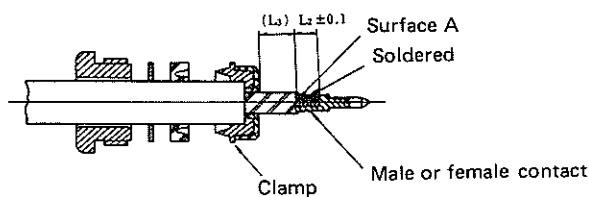

- (1) Insert clamp from tip of cable and fold outer conductor of cable back onto clamp. Using a knife, cut off excess outer conductor left at this time.
- (2) Cut off center conductor of cable at L_2 , from surface A of cable insulation. For end processing dimensions L_2 , L_B , refer to Table 1, End processing dimensions arranged by part (L_3 is a reference dimension.)
(Note: Be careful not to damage center conductor.)
- (3) Solder contact and center conductor. It is a good idea at this time to solder the terminal preliminarily in advance.
(Note: There must be no gap between the end and the cable insulation.)



Insert cable and parts into shell and tighten tightening nut sufficiently.

BNC SERIES RF CO-AXIAL CONNECTORS

Assembling methods

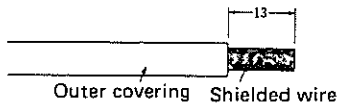

1. Cut off 13mm of the cable's outer covering and expose the shielded wire.

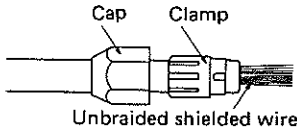

2. Put the cap through the cable, insert the clamp, and unbraided the shielded wire.

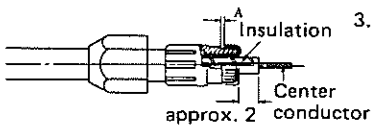

3. Wind the shielded wire onto the clamp. At this time, cut off the shielded wire at position A in the drawing, leaving some gap.

4. Cut off the insulation, leaving about 2mm of it.

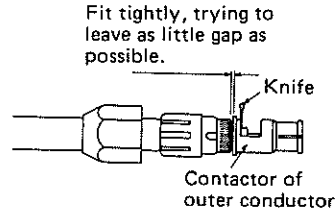

5. Fit the contactor of the outer conductor tightly onto the clamp, position a knife on the notched window, and cut off the insulation. Take care not to damage the center conductor at this time.

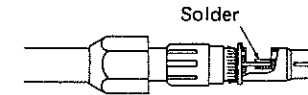

6. Solder the center conductor with the contactor of the outer conductor fitting tightly onto the clamp.

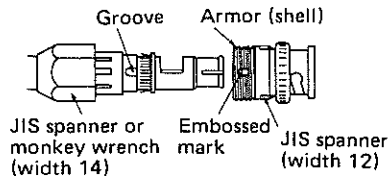

7. Insert the block described above so that it will fit into the groove on the clamp and the embossed mark on the armor. Tighten the cap thoroughly. The tools used are a JIS spanner (width 12) and a JIS spanner or monkey wrench (width 14).

Non-reflective Terminations (BNC)

BNC-TM Series



■ Features

1. High Performance

These wide bandwidth/ultra high matching non-reflective termination use Hirose Electric original high frequency matching technology.

2. Full Assortment of 50 ohms and 75 ohms Types

In addition to the 50 ohms impedance type, plugs and jacks are available in a 75 ohms type.

■ Product Specifications

Ratings	Frequency range (Note) Characteristic impedance Maximum Input Power (Note)	DC to 4.0 GHz 50 ohms, 75 ohms 0.5 to 1 W	Operating temperature range Operating relative humidity	-10°C to +65°C 95% Max.
---------	--	---	--	----------------------------

Note: The frequency range and the maximum input power will differ depending on the products.

Item	Standard	Conditions
1. Vibration	No electrical discontinuity of 1 μs or more No damage, cracks, or parts dislocation	Frequency of 10 to 2000 Hz, overall amplitude of 1.52 mm, acceleration of 98 m/s ² for 2 hours in each of 3 directions
2. Shock		Acceleration of 490 m/s ² , sine half-wave waveform, 3 cycles in each of the 3 axis
3. Temperature cycle	No electrical discontinuity of 1 μs or more	Temperature: -55°C → +15°C to +35°C → +85°C → +15°C to +35°C Time: 30 → 15 max. → 30 → 15 max. (Minutes) 100 cycles

● The test method conforms to MIL-STD-202.

■ Materials

Part	Material	Finish
Connector Body	Brass	Nickel plating
Insulator	PTFE	—
Male contacts	Brass	Gold plating
Female contacts	Beryllium copper	Gold plating
Resistor	Metal film	—
Cover	PVC	—

■ Ordering Information

BNC - TMP - 05 - 1 (41)
 ① ② ③ ④ ⑤ ⑥

① Series Name: BNC Series	④ Power (Example) : 05: 0.5 W
② TM: Indicates a non-reflective termination	1 : 1 W
③ Connector type P: Plug type J: Jack type	⑤ Suffix
	⑥ (4*): RoHS Compliant

■ Specifications

Part Number	Frequency Range (GHz)	V.S.W.R. (Max)	Power (W)	Impedance (Ohms)	Direct Current Resistance	Connectors	Weight (g)	RoHS
BNC-TMP-05(43)	DC~1 1~3	1.10	0.5	50	50±0.5	BNC-P	15	YES
BNC-TMJ-05(42)		1.20	0.5	50	50±0.5	BNC-J	10	
※1 BNC-TMP-05-1(41)	DC~0.1	1.10	0.5	50	50±0.5	BNC-P	15	
※1 BNC-TMJ-05-1(41)			0.5	50	50±0.5	BNC-J	10	
※2 BNC-TMP-05-2(42)	DC~1 1~3	1.10	0.5	50	50±0.5	BNC-P	16	
※2 BNC-TMJ-05-2(42)		1.20	0.5	50	50±0.5	BNC-J	11	
BNC-TMP-05(75)(40)	DC~0.5 0.5~2	1.15	0.5	75	75±2.25	BNC-P(75)	14	
BNC-TMJ-05(75)(40)		1.20	0.5	75	75±2.25	BNC-J(75)	9	
BNC-TMP-1(42)	DC~1	1.15	1	50	50±2	BNC-P	16	
	1~2	1.20						
	2~4	1.25						

※1 Low-cost items with DC to 100 MHz bandwidth limit.

※2 Cover fitting type

■ Typical Data

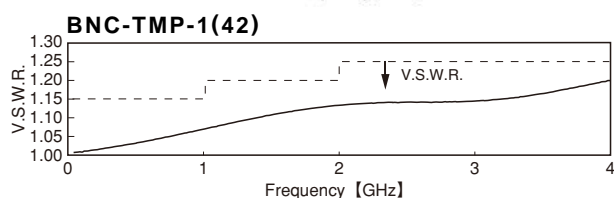
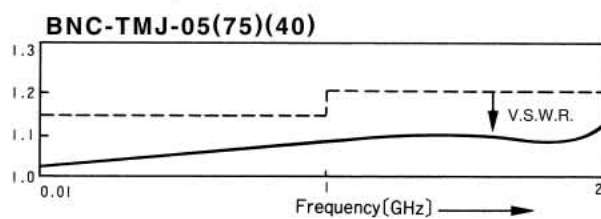
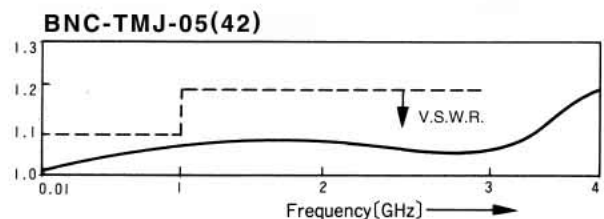
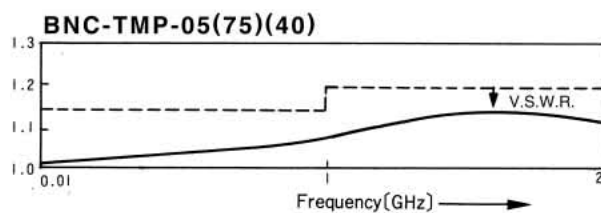
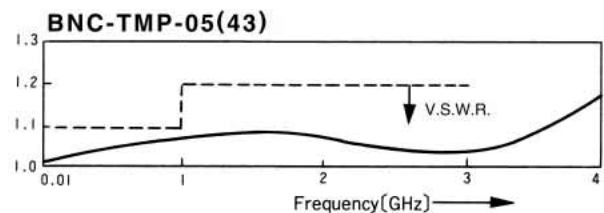

External Dimensions

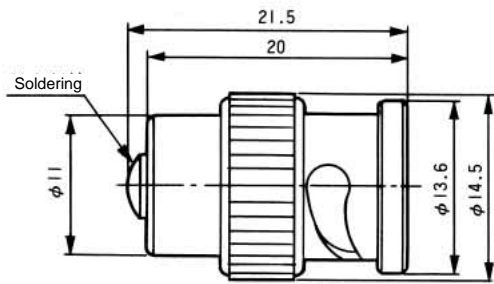

BNC - TMP - 05(43)
BNC - TMP - 05-1(41)
BNC - TMP - 05(75)(40)

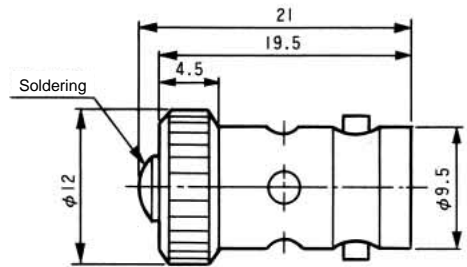

BNC - TMJ - 05(42)
BNC - TMJ - 05-1(41)
BNC - TMJ - 05(75)(40)

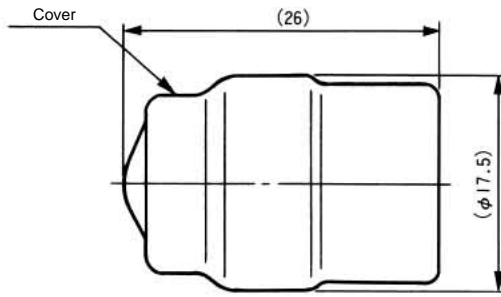

BNC - TMP - 05-2(42)

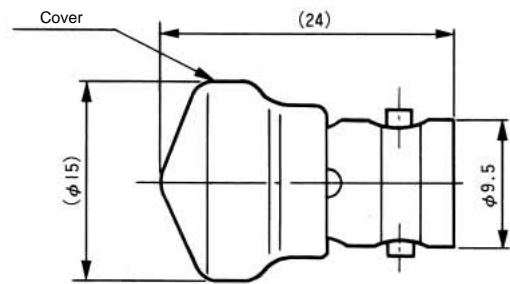

BNC - TMJ - 05-2(42)

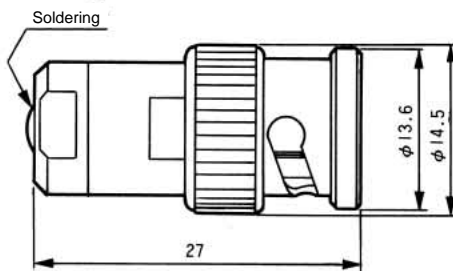

BNC - TMP - 1(42)

※BNC-TMP/TMJ-05 Series have a 50 ohms or 75 ohms indication for each characteristic impedance.

Mouser Electronics

Authorized Distributor

Click to View Pricing, Inventory, Delivery & Lifecycle Information:

Hirose Electric:

[3CV-PL\(40\)](#) [3C-R\(40\)](#) [3CV-J\(40\)](#) [3CV-P2\(40\)](#) [UG-57B/U\(40\)](#) [UG-58A/U\(45\)](#) [UG-625/U\(40\)](#) [UG-88/U\(40\)](#) [UG-913/U\(42\)](#) [UG-291/U\(40\)](#)