



Reference Specification

Leaded MLCC for Automotive with AEC-Q200
RCE Series

Product specifications in this catalog are as of Dec. 2017, and are subject to change or obsolescence without notice.

Please consult the approval sheet before ordering. Please read rating and Cautions first.

Reference only

⚠ CAUTION

1. OPERATING VOLTAGE

When DC-rated capacitors are to be used in AC or ripple current circuits, be sure to maintain the V_{p-p} value of the applied voltage or the V_{o-p} which contains DC bias within the rated voltage range. When the voltage is started to apply to the circuit or it is stopped applying, the irregular voltage may be generated for a transit period because of resonance or switching. Be sure to use a capacitor within rated voltage containing these irregular voltage.

When DC-rated capacitors are to be used in input circuits from commercial power source (AC filter), be sure to use Safety Recognized Capacitors because various regulations on withstand voltage or impulse withstand established for each equipment should be taken into considerations.

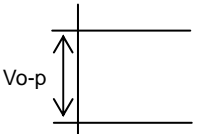
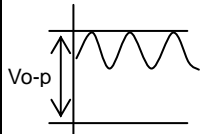
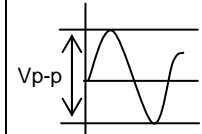
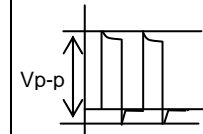
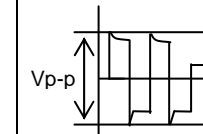
Voltage	DC Voltage	DC+AC Voltage	AC Voltage	Pulse Voltage(1)	Pulse Voltage(2)
Positional Measurement					

2. OPERATING TEMPERATURE AND SELF-GENERATED HEAT

Keep the surface temperature of a capacitor below the upper limit of its rated operating temperature range. Be sure to take into account the heat generated by the capacitor itself.

When the capacitor is used in a high-frequency current, pulse current or the like, it may have the self-generated heat due to dielectric-loss. In case of Class 2 capacitors (Temp.Char. : X7R,X7S,X8L, etc.), applied voltage should be the load such as self-generated heat is within 20 °C on the condition of atmosphere temperature 25 °C. Please contact us if self-generated heat is occurred with Class 1 capacitors (Temp.Char. : C0G,U2J,X8G, etc.). When measuring, use a thermocouple of small thermal capacity-K of $\phi 0.1$ mm and be in the condition where capacitor is not affected by radiant heat of other components and wind of surroundings. Excessive heat may lead to deterioration of the capacitor's characteristics and reliability.

3. Fail-safe

Be sure to provide an appropriate fail-safe function on your product to prevent a second damage that may be caused by the abnormal function or the failure of our product.

4. OPERATING AND STORAGE ENVIRONMENT

The insulating coating of capacitors does not form a perfect seal; therefore, do not use or store capacitors in a corrosive atmosphere, especially where chloride gas, sulfide gas, acid, alkali, salt or the like are present. And avoid exposure to moisture. Before cleaning, bonding, or molding this product, verify that these processes do not affect product quality by testing the performance of a cleaned, bonded or molded product in the intended equipment. Store the capacitors where the temperature and relative humidity do not exceed 5 to 40 °C and 20 to 70%. Use capacitors within 6 months.

5. VIBRATION AND IMPACT

Do not expose a capacitor or its leads to excessive shock or vibration during use.

6. SOLDERING

When soldering this product to a PCB/PWB, do not exceed the solder heat resistance specification of the capacitor. Subjecting this product to excessive heating could melt the internal junction solder and may result in thermal shocks that can crack the ceramic element.

7. BONDING AND RESIN MOLDING, RESIN COAT

In case of bonding, molding or coating this product, verify that these processes do not affect the quality of capacitor by testing the performance of a bonded or molded product in the intended equipment.

In case of the amount of applications, dryness / hardening conditions of adhesives and molding resins containing organic solvents (ethyl acetate, methyl ethyl ketone, toluene, etc.) are unsuitable, the outer coating resin of a capacitor is damaged by the organic solvents and it may result, worst case, in a short circuit.

The variation in thickness of adhesive or molding resin may cause a outer coating resin cracking and/or ceramic element cracking of a capacitor in a temperature cycling.

8. TREATMENT AFTER BONDING AND RESIN MOLDING, RESIN COAT

When the outer coating is hot (over 100 °C) after soldering, it becomes soft and fragile.

So please be careful not to give it mechanical stress.

Reference only

Failure to follow the above cautions may result, worst case, in a short circuit and cause fuming or partial dispersion when the product is used.

9. LIMITATION OF APPLICATIONS

Please contact us before using our products for the applications listed below which require especially high reliability for the prevention of defects which might directly cause damage to the third party's life, body or property.

1. Aircraft equipment
2. Aerospace equipment
3. Undersea equipment
4. Power plant control equipment
5. Medical equipment
6. Transportation equipment (vehicles, trains, ships, etc.)
7. Traffic signal equipment
8. Disaster prevention / crime prevention equipment
9. Data-processing equipment exerting influence on public
10. Application of similar complexity and/or reliability requirements to the applications listed in the above.

NOTICE

1. CLEANING (ULTRASONIC CLEANING)

To perform ultrasonic cleaning, observe the following conditions.

Rinse bath capacity : Output of 20 watts per liter or less.

Rinsing time : 5 min maximum.

Do not vibrate the PCB/PWB directly.

Excessive ultrasonic cleaning may lead to fatigue destruction of the lead wires.

2. Soldering and Mounting

Insertion of the Lead Wire

- When soldering, insert the lead wire into the PCB without mechanically stressing the lead wire.
- Insert the lead wire into the PCB with a distance appropriate to the lead space.

3. CAPACITANCE CHANGE OF CAPACITORS

- Class 2 capacitors (Temp.Char. : X7R,X7S,X8L, etc.)

Class 2 capacitors an aging characteristic, whereby the capacitor continually decreases its capacitance slightly if the capacitor leaves for a long time. Moreover, capacitance might change greatly depending on a surrounding temperature or an applied voltage. So, it is not likely to be able to use for the time constant circuit.

Please contact us if you need a detail information.

NOTE

1. Please make sure that your product has been evaluated in view of your specifications with our product being mounted to your product.
2. You are requested not to use our product deviating from this specification.

Reference only

1. Application

This specification is applied to Leaded MLCC RCE series in accordance with AEC-Q200 requirements used for Automotive Electronic equipment.

2. Rating

- Part number configuration

ex.)	RCE	7U	2E	102	J	1	K1	H03	B
	Series	Temperature Characteristic	Rated voltage	Capacitance	Capacitance tolerance	Dimension code	Lead code	Individual specification code	Packing style code

- Temperature characteristic

Code	Temp. Char.	Temp. Range	Cap. Change (Within%)	Standard Temp.	Operating Temp. Range
7U	U2J	25~125°C	750+/-120	25°C	-55~125°C

- Rated voltage

Code	Rated voltage
2E	DC250V
2J	DC630V
3A	DC1000V

- Capacitance

The first two digits denote significant figures ; the last digit denotes the multiplier of 10 in pF.
ex.) In case of 102.

$$10 \times 10^2 = 1000\text{pF}$$

- Capacitance tolerance

Code	Capacitance Tolerance
J	+/-5%

- Dimension code

Code	Dimensions (LxW) mm max.
1	4.0 x 3.5
2	5.5 x 4.0
3	5.5 x 5.0
4	7.5 x 5.5
5	7.5 x 8.0
U	7.7 x 13.0

- Lead code

Code	Lead style	Lead spacing (mm)
B1	Straight type	5.0+/-0.8
E1	Straight taping type	5.0+0.6/-0.2
K1	Inside crimp type	5.0+/-0.8
M1	Inside crimp taping type	5.0+0.6/-0.2

Lead wire is solder coated CP wire.

Reference only

- Individual specification code
Murata's control code
Please refer to [Part number list].







- Packing style code

Code	Packing style
A	Taping type of Ammo
B	Bulk type

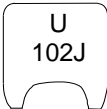
3. Marking

- Temp. char. : Letter code : U(U2J Char.)
 Capacitance : Actual numbers (Less than 100pF)
 3 digit numbers (100pF and over)
 Capacitance tolerance : Code
 Rated voltage : Letter code : 4 (DC250V only. Except dimension code : 1)
 Letter code : 7 (DC630V only.)
 Letter code : A (DC1000V only.)
 Company name code : Abbreviation :  (Except dimension code : 1)

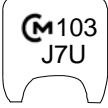
(Ex.)

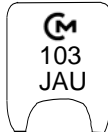
Rated voltage Dimensions	DC250V	DC630V	DC1000V
1		—	—
2			
3,4			
5,U	—		

Reference only

4. Part number list

• Inside Crimp
(Lead Code: K1)

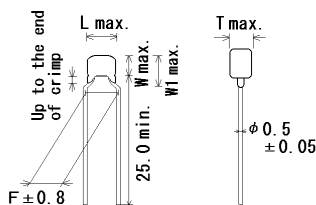

• Straight Long
(Lead Code: B1)

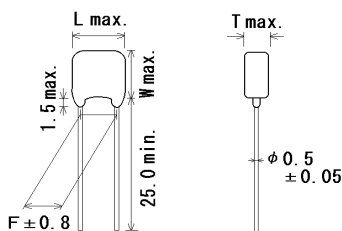

• Straight Long
(Size Lead Code: UB1)

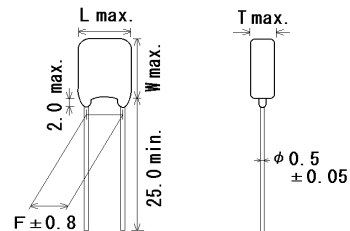

Unit : mm

Customer Part Number	Murata Part Number	T.C.	DC Rated Volt. (V)	Cap.	Cap. tol.	Dimension (mm)					Size Lead Code	Pack qty. (pcs)
						L	W	W1	F	T		
	RCE7U2E101J1K1H03B	U2J	250	100pF	±5%	4.0	3.5	5.0	5.0	3.15	1K1	500
	RCE7U2E151J1K1H03B	U2J	250	150pF	±5%	4.0	3.5	5.0	5.0	3.15	1K1	500
	RCE7U2E221J1K1H03B	U2J	250	220pF	±5%	4.0	3.5	5.0	5.0	3.15	1K1	500
	RCE7U2E331J1K1H03B	U2J	250	330pF	±5%	4.0	3.5	5.0	5.0	3.15	1K1	500
	RCE7U2E471J1K1H03B	U2J	250	470pF	±5%	4.0	3.5	5.0	5.0	3.15	1K1	500
	RCE7U2E681J1K1H03B	U2J	250	680pF	±5%	4.0	3.5	5.0	5.0	3.15	1K1	500
	RCE7U2E102J1K1H03B	U2J	250	1000pF	±5%	4.0	3.5	5.0	5.0	3.15	1K1	500
	RCE7U2E152J1K1H03B	U2J	250	1500pF	±5%	4.0	3.5	5.0	5.0	3.15	1K1	500
	RCE7U2E222J1K1H03B	U2J	250	2200pF	±5%	4.0	3.5	5.0	5.0	3.15	1K1	500
	RCE7U2E332J1K1H03B	U2J	250	3300pF	±5%	4.0	3.5	5.0	5.0	3.15	1K1	500
	RCE7U2E472J1K1H03B	U2J	250	4700pF	±5%	4.0	3.5	5.0	5.0	3.15	1K1	500
	RCE7U2E682J2K1H03B	U2J	250	6800pF	±5%	5.5	4.0	6.0	5.0	3.15	2K1	500
	RCE7U2E103J2K1H03B	U2J	250	10000pF	±5%	5.5	4.0	6.0	5.0	3.15	2K1	500
	RCE7U2J100J2K1H03B	U2J	630	10pF	±5%	5.5	4.0	6.0	5.0	3.15	2K1	500
	RCE7U2J150J2K1H03B	U2J	630	15pF	±5%	5.5	4.0	6.0	5.0	3.15	2K1	500
	RCE7U2J220J2K1H03B	U2J	630	22pF	±5%	5.5	4.0	6.0	5.0	3.15	2K1	500
	RCE7U2J330J2K1H03B	U2J	630	33pF	±5%	5.5	4.0	6.0	5.0	3.15	2K1	500
	RCE7U2J470J2K1H03B	U2J	630	47pF	±5%	5.5	4.0	6.0	5.0	3.15	2K1	500
	RCE7U2J680J2K1H03B	U2J	630	68pF	±5%	5.5	4.0	6.0	5.0	3.15	2K1	500
	RCE7U2J101J2K1H03B	U2J	630	100pF	±5%	5.5	4.0	6.0	5.0	3.15	2K1	500
	RCE7U2J151J2K1H03B	U2J	630	150pF	±5%	5.5	4.0	6.0	5.0	3.15	2K1	500
	RCE7U2J221J2K1H03B	U2J	630	220pF	±5%	5.5	4.0	6.0	5.0	3.15	2K1	500
	RCE7U2J331J2K1H03B	U2J	630	330pF	±5%	5.5	4.0	6.0	5.0	3.15	2K1	500
	RCE7U2J471J2K1H03B	U2J	630	470pF	±5%	5.5	4.0	6.0	5.0	3.15	2K1	500
	RCE7U2J681J2K1H03B	U2J	630	680pF	±5%	5.5	4.0	6.0	5.0	3.15	2K1	500
	RCE7U2J102J2K1H03B	U2J	630	1000pF	±5%	5.5	4.0	6.0	5.0	3.15	2K1	500
	RCE7U2J152J2K1H03B	U2J	630	1500pF	±5%	5.5	4.0	6.0	5.0	3.15	2K1	500
	RCE7U2J222J2K1H03B	U2J	630	2200pF	±5%	5.5	4.0	6.0	5.0	3.15	2K1	500
	RCE7U2J332J2K1H03B	U2J	630	3300pF	±5%	5.5	4.0	6.0	5.0	3.15	2K1	500
	RCE7U2J472J2K1H03B	U2J	630	4700pF	±5%	5.5	4.0	6.0	5.0	3.15	2K1	500
	RCE7U2J682J3K1H03B	U2J	630	6800pF	±5%	5.5	5.0	7.5	5.0	4.0	3K1	500
	RCE7U2J103J3K1H03B	U2J	630	10000pF	±5%	5.5	5.0	7.5	5.0	4.0	3K1	500
	RCE7U2J153J4K1H03B	U2J	630	15000pF	±5%	7.5	5.5	8.0	5.0	4.0	4K1	500
	RCE7U2J223J4K1H03B	U2J	630	22000pF	±5%	7.5	5.5	8.0	5.0	4.0	4K1	500
	RCE7U2J333J5B1H03B	U2J	630	33000pF	±5%	7.5	8.0	-	5.0	4.0	5B1	500
	RCE7U2J473J5B1H03B	U2J	630	47000pF	±5%	7.5	8.0	-	5.0	4.0	5B1	500
	RCE7U2J943JUB1H03B	U2J	630	94000pF	±5%	7.7	13.0	-	5.0	4.0	UB1	200

Reference only

• Inside Crimp
(Lead Code:K1)

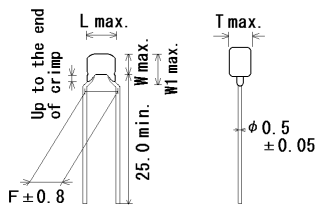

• Straight Long
(Lead Code:B1)

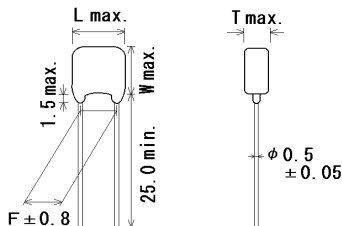

• Straight Long
(Size Lead Code:UB1)

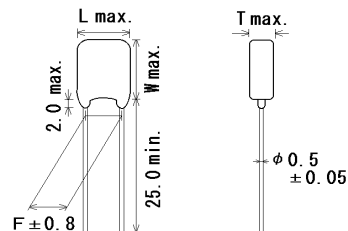

Unit : mm

Customer Part Number	Murata Part Number	T.C.	DC Rated Volt. (V)	Cap.	Cap. tol.	Dimension (mm)					Size Lead Code	Pack qty. (pcs)
						L	W	W1	F	T		
	RCE7U3A100J2K1H03B	U2J	1000	10pF	±5%	5.5	4.0	6.0	5.0	3.15	2K1	500
	RCE7U3A150J2K1H03B	U2J	1000	15pF	±5%	5.5	4.0	6.0	5.0	3.15	2K1	500
	RCE7U3A220J2K1H03B	U2J	1000	22pF	±5%	5.5	4.0	6.0	5.0	3.15	2K1	500
	RCE7U3A330J2K1H03B	U2J	1000	33pF	±5%	5.5	4.0	6.0	5.0	3.15	2K1	500
	RCE7U3A470J2K1H03B	U2J	1000	47pF	±5%	5.5	4.0	6.0	5.0	3.15	2K1	500
	RCE7U3A680J2K1H03B	U2J	1000	68pF	±5%	5.5	4.0	6.0	5.0	3.15	2K1	500
	RCE7U3A101J2K1H03B	U2J	1000	100pF	±5%	5.5	4.0	6.0	5.0	3.15	2K1	500
	RCE7U3A151J2K1H03B	U2J	1000	150pF	±5%	5.5	4.0	6.0	5.0	3.15	2K1	500
	RCE7U3A221J2K1H03B	U2J	1000	220pF	±5%	5.5	4.0	6.0	5.0	3.15	2K1	500
	RCE7U3A331J2K1H03B	U2J	1000	330pF	±5%	5.5	4.0	6.0	5.0	3.15	2K1	500
	RCE7U3A471J2K1H03B	U2J	1000	470pF	±5%	5.5	4.0	6.0	5.0	3.15	2K1	500
	RCE7U3A681J2K1H03B	U2J	1000	680pF	±5%	5.5	4.0	6.0	5.0	3.15	2K1	500
	RCE7U3A102J2K1H03B	U2J	1000	1000pF	±5%	5.5	4.0	6.0	5.0	3.15	2K1	500
	RCE7U3A152J3K1H03B	U2J	1000	1500pF	±5%	5.5	5.0	7.5	5.0	4.0	3K1	500
	RCE7U3A222J3K1H03B	U2J	1000	2200pF	±5%	5.5	5.0	7.5	5.0	4.0	3K1	500
	RCE7U3A332J4K1H03B	U2J	1000	3300pF	±5%	7.5	5.5	8.0	5.0	4.0	4K1	500
	RCE7U3A472J4K1H03B	U2J	1000	4700pF	±5%	7.5	5.5	8.0	5.0	4.0	4K1	500
	RCE7U3A682J5B1H03B	U2J	1000	6800pF	±5%	7.5	8.0	-	5.0	4.0	5B1	500
	RCE7U3A103J5B1H03B	U2J	1000	10000pF	±5%	7.5	8.0	-	5.0	4.0	5B1	500
	RCE7U3A203JUB1H03B	U2J	1000	20000pF	±5%	7.7	13.0	-	5.0	4.0	UB1	200

Reference only

• Inside Crimp Taping
(Lead Code: M*)

• Straight Taping
(Lead Code: E*)

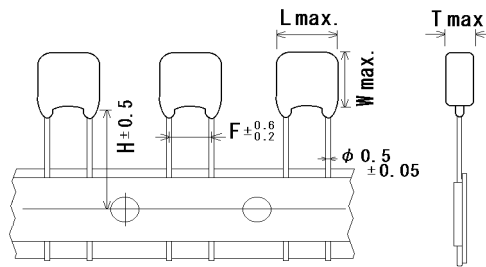
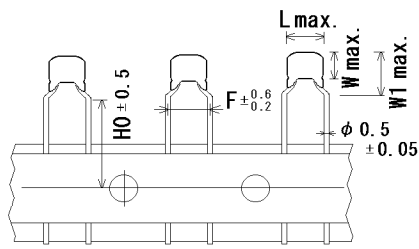

Unit : mm

Customer Part Number	Murata Part Number	T.C.	DC Rated volt. (V)	Cap.	Cap. tol.	Dimension (mm)						Size Lead Code	Pack qty. (pcs)
						L	W	W1	F	T	H/H0		
	RCE7U2E101J1M1H03A	U2J	250	100pF	±5%	4.0	3.5	5.0	5.0	3.15	16.0	1M1	2000
	RCE7U2E151J1M1H03A	U2J	250	150pF	±5%	4.0	3.5	5.0	5.0	3.15	16.0	1M1	2000
	RCE7U2E221J1M1H03A	U2J	250	220pF	±5%	4.0	3.5	5.0	5.0	3.15	16.0	1M1	2000
	RCE7U2E331J1M1H03A	U2J	250	330pF	±5%	4.0	3.5	5.0	5.0	3.15	16.0	1M1	2000
	RCE7U2E471J1M1H03A	U2J	250	470pF	±5%	4.0	3.5	5.0	5.0	3.15	16.0	1M1	2000
	RCE7U2E681J1M1H03A	U2J	250	680pF	±5%	4.0	3.5	5.0	5.0	3.15	16.0	1M1	2000
	RCE7U2E102J1M1H03A	U2J	250	1000pF	±5%	4.0	3.5	5.0	5.0	3.15	16.0	1M1	2000
	RCE7U2E152J1M1H03A	U2J	250	1500pF	±5%	4.0	3.5	5.0	5.0	3.15	16.0	1M1	2000
	RCE7U2E222J1M1H03A	U2J	250	2200pF	±5%	4.0	3.5	5.0	5.0	3.15	16.0	1M1	2000
	RCE7U2E332J1M1H03A	U2J	250	3300pF	±5%	4.0	3.5	5.0	5.0	3.15	16.0	1M1	2000
	RCE7U2E472J1M1H03A	U2J	250	4700pF	±5%	4.0	3.5	5.0	5.0	3.15	16.0	1M1	2000
	RCE7U2E682J2M1H03A	U2J	250	6800pF	±5%	5.5	4.0	6.0	5.0	3.15	16.0	2M1	2000
	RCE7U2E103J2M1H03A	U2J	250	10000pF	±5%	5.5	4.0	6.0	5.0	3.15	16.0	2M1	2000
	RCE7U2J100J2M1H03A	U2J	630	10pF	±5%	5.5	4.0	6.0	5.0	3.15	16.0	2M1	2000
	RCE7U2J150J2M1H03A	U2J	630	15pF	±5%	5.5	4.0	6.0	5.0	3.15	16.0	2M1	2000
	RCE7U2J220J2M1H03A	U2J	630	22pF	±5%	5.5	4.0	6.0	5.0	3.15	16.0	2M1	2000
	RCE7U2J330J2M1H03A	U2J	630	33pF	±5%	5.5	4.0	6.0	5.0	3.15	16.0	2M1	2000
	RCE7U2J470J2M1H03A	U2J	630	47pF	±5%	5.5	4.0	6.0	5.0	3.15	16.0	2M1	2000
	RCE7U2J680J2M1H03A	U2J	630	68pF	±5%	5.5	4.0	6.0	5.0	3.15	16.0	2M1	2000
	RCE7U2J101J2M1H03A	U2J	630	100pF	±5%	5.5	4.0	6.0	5.0	3.15	16.0	2M1	2000
	RCE7U2J151J2M1H03A	U2J	630	150pF	±5%	5.5	4.0	6.0	5.0	3.15	16.0	2M1	2000
	RCE7U2J221J2M1H03A	U2J	630	220pF	±5%	5.5	4.0	6.0	5.0	3.15	16.0	2M1	2000
	RCE7U2J331J2M1H03A	U2J	630	330pF	±5%	5.5	4.0	6.0	5.0	3.15	16.0	2M1	2000
	RCE7U2J471J2M1H03A	U2J	630	470pF	±5%	5.5	4.0	6.0	5.0	3.15	16.0	2M1	2000
	RCE7U2J681J2M1H03A	U2J	630	680pF	±5%	5.5	4.0	6.0	5.0	3.15	16.0	2M1	2000
	RCE7U2J102J2M1H03A	U2J	630	1000pF	±5%	5.5	4.0	6.0	5.0	3.15	16.0	2M1	2000
	RCE7U2J152J2M1H03A	U2J	630	1500pF	±5%	5.5	4.0	6.0	5.0	3.15	16.0	2M1	2000
	RCE7U2J222J2M1H03A	U2J	630	2200pF	±5%	5.5	4.0	6.0	5.0	3.15	16.0	2M1	2000
	RCE7U2J332J2M1H03A	U2J	630	3300pF	±5%	5.5	4.0	6.0	5.0	3.15	16.0	2M1	2000
	RCE7U2J472J2M1H03A	U2J	630	4700pF	±5%	5.5	4.0	6.0	5.0	3.15	16.0	2M1	2000
	RCE7U2J682J3M1H03A	U2J	630	6800pF	±5%	5.5	5.0	7.5	5.0	4.0	16.0	3M1	2000
	RCE7U2J103J3M1H03A	U2J	630	10000pF	±5%	5.5	5.0	7.5	5.0	4.0	16.0	3M1	2000
	RCE7U2J153J4M1H03A	U2J	630	15000pF	±5%	7.5	5.5	8.0	5.0	4.0	16.0	4M1	1500
	RCE7U2J223J4M1H03A	U2J	630	22000pF	±5%	7.5	5.5	8.0	5.0	4.0	16.0	4M1	1500
	RCE7U2J333J5E1H03A	U2J	630	33000pF	±5%	7.5	8.0	-	5.0	4.0	17.5	5E1	1500
	RCE7U2J473J5E1H03A	U2J	630	47000pF	±5%	7.5	8.0	-	5.0	4.0	17.5	5E1	1500
	RCE7U2J943JUE1H03A	U2J	630	94000pF	±5%	7.7	13.0	-	5.0	4.0	17.5	UE1	1500

Reference only

• Inside Crimp Taping
(Lead Code: M*)

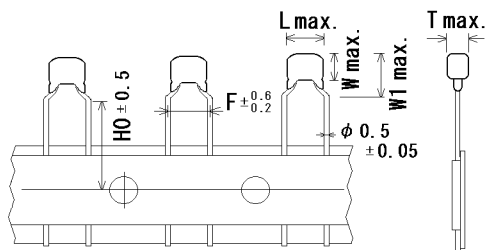

• Straight Taping
(Lead Code: E*)

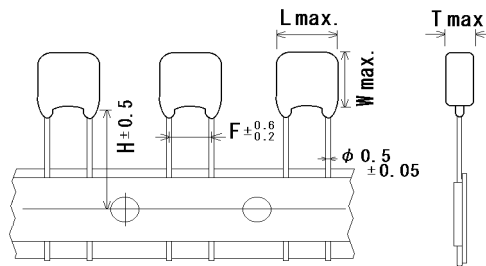

Unit : mm

Customer Part Number	Murata Part Number	T.C.	DC Rated volt. (V)	Cap.	Cap. tol.	Dimension (mm)						Size Lead Code	Pack qty. (pcs)
						L	W	W1	F	T	H/H0		
	RCE7U3A100J2M1H03A	U2J	1000	10pF	±5%	5.5	4.0	6.0	5.0	3.15	16.0	2M1	2000
	RCE7U3A150J2M1H03A	U2J	1000	15pF	±5%	5.5	4.0	6.0	5.0	3.15	16.0	2M1	2000
	RCE7U3A220J2M1H03A	U2J	1000	22pF	±5%	5.5	4.0	6.0	5.0	3.15	16.0	2M1	2000
	RCE7U3A330J2M1H03A	U2J	1000	33pF	±5%	5.5	4.0	6.0	5.0	3.15	16.0	2M1	2000
	RCE7U3A470J2M1H03A	U2J	1000	47pF	±5%	5.5	4.0	6.0	5.0	3.15	16.0	2M1	2000
	RCE7U3A680J2M1H03A	U2J	1000	68pF	±5%	5.5	4.0	6.0	5.0	3.15	16.0	2M1	2000
	RCE7U3A101J2M1H03A	U2J	1000	100pF	±5%	5.5	4.0	6.0	5.0	3.15	16.0	2M1	2000
	RCE7U3A151J2M1H03A	U2J	1000	150pF	±5%	5.5	4.0	6.0	5.0	3.15	16.0	2M1	2000
	RCE7U3A221J2M1H03A	U2J	1000	220pF	±5%	5.5	4.0	6.0	5.0	3.15	16.0	2M1	2000
	RCE7U3A331J2M1H03A	U2J	1000	330pF	±5%	5.5	4.0	6.0	5.0	3.15	16.0	2M1	2000
	RCE7U3A471J2M1H03A	U2J	1000	470pF	±5%	5.5	4.0	6.0	5.0	3.15	16.0	2M1	2000
	RCE7U3A681J2M1H03A	U2J	1000	680pF	±5%	5.5	4.0	6.0	5.0	3.15	16.0	2M1	2000
	RCE7U3A102J2M1H03A	U2J	1000	1000pF	±5%	5.5	4.0	6.0	5.0	3.15	16.0	2M1	2000
	RCE7U3A152J3M1H03A	U2J	1000	1500pF	±5%	5.5	5.0	7.5	5.0	4.0	16.0	3M1	2000
	RCE7U3A222J3M1H03A	U2J	1000	2200pF	±5%	5.5	5.0	7.5	5.0	4.0	16.0	3M1	2000
	RCE7U3A332J4M1H03A	U2J	1000	3300pF	±5%	7.5	5.5	8.0	5.0	4.0	16.0	4M1	1500
	RCE7U3A472J4M1H03A	U2J	1000	4700pF	±5%	7.5	5.5	8.0	5.0	4.0	16.0	4M1	1500
	RCE7U3A682J5E1H03A	U2J	1000	6800pF	±5%	7.5	8.0	-	5.0	4.0	17.5	5E1	1500
	RCE7U3A103J5E1H03A	U2J	1000	10000pF	±5%	7.5	8.0	-	5.0	4.0	17.5	5E1	1500
	RCE7U3A203JUE1H03A	U2J	1000	20000pF	±5%	7.7	13.0	-	5.0	4.0	17.5	UE1	1500

Reference only

5. AEC-Q200 Murata Standard Specifications and Test Methods

No.	AEC-Q200 Test Item	Specification	AEC-Q200 Test Method															
1	Pre-and Post-Stress Electrical Test	-																
2	High Temperature Exposure (Storage)	Appearance	No defects or abnormalities															
		Capacitance Change	Within $\pm 3\%$ or $\pm 0.3\text{pF}$ (Whichever is larger)															
		Q	$30\text{pF} \leq C : Q \geq 350$ $10\text{pF} \leq C < 30\text{pF} : Q \geq 275+5C/2$ $10\text{pF} > C : Q \geq 200+10C$ C : Nominal Capacitance (pF)															
		I.R.	More than $1,000\text{M}\Omega$ or $50\text{M}\Omega \cdot \mu\text{F}$ (Whichever is smaller)															
			Sit the capacitor for $1,000 \pm 12\text{h}$ at $150 \pm 3^\circ\text{C}$. Let sit for $24 \pm 2\text{h}$ at *room condition, then measure.															
3	Temperature Cycling	Appearance	No defects or abnormalities															
		Capacitance Change	Within $\pm 5\%$ or $\pm 0.5\text{pF}$ (Whichever is larger)															
		Q	$30\text{pF} \leq C : Q \geq 350$ $10\text{pF} \leq C < 30\text{pF} : Q \geq 275+5C/2$ $10\text{pF} > C : Q \geq 200+10C$ C : Nominal Capacitance (pF)															
		I.R.	$1,000\text{M}\Omega$ or $50\text{M}\Omega \cdot \mu\text{F}$ min. (Whichever is smaller)															
			Perform the 1,000 cycles according to the four heat treatments listed in the following table. Let sit for $24 \pm 2\text{h}$ at *room condition, then measure.															
			<table border="1"> <thead> <tr> <th>Step</th> <th>1</th> <th>2</th> <th>3</th> <th>4</th> </tr> </thead> <tbody> <tr> <td>Temp. ($^\circ\text{C}$)</td> <td>$-55+0/-3$</td> <td>Room Temp.</td> <td>$125+3/-0$</td> <td>Room Temp.</td> </tr> <tr> <td>Time (min.)</td> <td>15 ± 3</td> <td>1</td> <td>15 ± 3</td> <td>1</td> </tr> </tbody> </table>	Step	1	2	3	4	Temp. ($^\circ\text{C}$)	$-55+0/-3$	Room Temp.	$125+3/-0$	Room Temp.	Time (min.)	15 ± 3	1	15 ± 3	1
Step	1	2	3	4														
Temp. ($^\circ\text{C}$)	$-55+0/-3$	Room Temp.	$125+3/-0$	Room Temp.														
Time (min.)	15 ± 3	1	15 ± 3	1														
4	Moisture Resistance	Appearance	No defects or abnormalities															
		Capacitance Change	Within $\pm 5\%$ or $\pm 0.5\text{pF}$ (Whichever is larger)															
		Q	$30\text{pF} \leq C : Q \geq 200$ $30\text{pF} > C : Q \geq 100+10C/3$ C : Nominal Capacitance(pF)															
		I.R.	$500\text{M}\Omega$ or $25\text{M}\Omega \cdot \mu\text{F}$ min. (Whichever is smaller)															
			Apply the 24h heat (25 to 65°C) and humidity (80 to 98%) treatment shown below, 10 consecutive times. Let sit for $24 \pm 2\text{h}$ at *room condition, then measure.															
			<p>Temperature ($^\circ\text{C}$)</p> <p>Humidity 90-98%</p> <p>Humidity 80-98%</p> <p>Humidity 90-98%</p> <p>Humidity 80-98%</p> <p>Humidity 90-98%</p> <p>Temperature ($^\circ\text{C}$)</p> <p>70</p> <p>65</p> <p>60</p> <p>55</p> <p>50</p> <p>45</p> <p>40</p> <p>35</p> <p>30</p> <p>25</p> <p>20</p> <p>15</p> <p>10</p> <p>5</p> <p>0</p> <p>-5</p> <p>-10</p> <p>Initial measurement</p> <p>+10</p> <p>-2 $^\circ\text{C}$</p> <p>One cycle 24 hours</p> <p>Hours</p> <p>0 1 2 3 4 5 6 7 8 9 10 11 12 13 14 15 16 17 18 19 20 21 22 23 24</p>															
5	Biased Humidity	Appearance	No defects or abnormalities															
		Capacitance Change	Within $\pm 5\%$ or $\pm 0.5\text{pF}$ (Whichever is larger)															
		Q	$30\text{pF} \leq C : Q \geq 200$ $30\text{pF} > C : Q \geq 100+10C/3$ C : Nominal Capacitance(pF)															
		I.R.	$500\text{M}\Omega$ or $25\text{M}\Omega \cdot \mu\text{F}$ min. (Whichever is smaller)															
			Apply the rated voltage and DC $1.3+0.2/-0\text{V}$ (add $100\text{k}\Omega$ resistor) at $85 \pm 3^\circ\text{C}$ and 80 to 85% humidity for $1,000 \pm 12\text{h}$. Remove and let sit for $24 \pm 2\text{h}$ at *room condition, then measure. The charge/discharge current is less than 50mA .															

* "room condition" Temperature: 15 to 35°C , Relative humidity: 45 to 75% , Atmosphere pressure: 86 to 106kPa

Reference only

No.	AEC-Q200 Test Item		Specification	AEC-Q200 Test Method									
6	Operational Life	Appearance	No defects or abnormalities	Apply voltage in Table for 1,000±12h at 125±3°C. Let sit for 24±2 h at *room condition, then measure. The charge/discharge current is less than 50mA. <table border="1" style="margin-left: 20px;"> <thead> <tr> <th>Rated Voltage</th> <th>Test Voltage</th> </tr> </thead> <tbody> <tr> <td>DC250V</td> <td>150% of the rated voltage</td> </tr> <tr> <td>DC630V</td> <td rowspan="2">120% of the rated voltage</td> </tr> <tr> <td>DC1000V</td> </tr> </tbody> </table>	Rated Voltage	Test Voltage	DC250V	150% of the rated voltage	DC630V	120% of the rated voltage	DC1000V		
		Rated Voltage	Test Voltage										
		DC250V	150% of the rated voltage										
		DC630V	120% of the rated voltage										
DC1000V													
Capacitance Change	Within ±3% or ±0.3pF (Whichever is larger)												
Q	30pF ≤ C : Q ≥ 350 10pF ≤ C < 30pF : Q ≥ 275+5C/2 10pF > C : Q ≥ 200+10C C : Nominal Capacitance (pF)												
I.R.	1,000MΩ or 50MΩ·μF min. (Whichever is smaller)												
7	External Visual		No defects or abnormalities	Visual inspection									
8	Physical Dimension		Within the specified dimensions	Using calipers and micrometers.									
9	Marking		To be easily legible.	Visual inspection									
10	Resistance to Solvents	Appearance	No defects or abnormalities	Per MIL-STD-202 Method 215 Solvent 1 : 1 part (by volume) of isopropyl alcohol 3 parts (by volume) of mineral spirits Solvent 2 : Terpene defluxer Solvent 3 : 42 parts (by volume) of water 1part (by volume) of propylene glycol monomethyl ether 1 part (by volume) of monoethanolamine									
		Capacitance	Within the specified tolerance										
		Q	30pF ≤ C : Q ≥ 1,000 30pF > C : Q ≥ 400+20C C : Nominal Capacitance (pF)										
		I.R.	More than 10,000MΩ or 500 MΩ·μF (Whichever is smaller)										
11	Mechanical Shock	Appearance	No defects or abnormalities	Three shocks in each direction should be applied along 3 mutually perpendicular axes of the test specimen (18 shocks). The specified test pulse should be Half-sine and should have a duration :0.5ms, peak value:1,500G and velocity change: 4.7m/s.									
		Capacitance	Within the specified tolerance										
		Q	30pF ≤ C : Q ≥ 1,000 30pF > C : Q ≥ 400+20C C : Nominal Capacitance (pF)										
12	Vibration	Appearance	No defects or abnormalities	The capacitor should be subjected to a simple harmonic motion having a total amplitude of 1.5mm, the frequency being varied uniformly between the approximate limits of 10 and 2,000Hz. The frequency range, from 10 to 2,000Hz and return to 10Hz, should be traversed in approximately 20 min. This motion should be applied for 12 items in each 3 mutually perpendicular directions (total of 36 times).									
		Capacitance	Within the specified tolerance										
		Q	30pF ≤ C : Q ≥ 1,000 30pF > C : Q ≥ 400+20C C : Nominal Capacitance (pF)										
13-1	Resistance to Soldering Heat (Non-Preheat)	Appearance	No defects or abnormalities	The lead wires should be immersed in the melted solder 1.5 to 2.0mm from the root of terminal at 260±5°C for 10±1 seconds. • Post-treatment Capacitor should be stored for 24±2 hours at *room condition.									
		Capacitance Change	Within ±2.5% or ±0.25pF (Whichever is larger)										
		Dielectric Strength (Between terminals)	No defects										
13-2	Resistance to Soldering Heat (On-Preheat)	Appearance	No defects or abnormalities	First the capacitor should be stored at 120+0/-5°C for 60+0/-5 seconds. Then, the lead wires should be immersed in the melted solder 1.5 to 2.0mm from the root of terminal at 260±5°C for 7.5+0/-1 seconds. • Post-treatment Capacitor should be stored for 24±2 hours at *room condition.									
		Capacitance Change	Within ±2.5% or ±0.25pF (Whichever is larger)										
		Dielectric Strength (Between terminals)	No defects										
13-3	Resistance to Soldering Heat (soldering iron method)	Appearance	No defects or abnormalities	Test condition Temperature of iron-tip : 350±10°C Soldering time : 3.5±0.5 seconds Soldering position Straight Lead:1.5 to 2.0mm from the root of terminal. Crimp Lead:1.5 to 2.0mm from the end of lead bend. • Post-treatment Capacitor should be stored for 24±2 hours at *room condition.									
		Capacitance Change	Within ±2.5% or ±0.25pF (Whichever is larger)										
		Dielectric Strength (Between terminals)	No defects										
14	Thermal Shock	Appearance	No defects or abnormalities	Perform the 300 cycles according to the two heat treatments listed in the following table(Maximum transfer time is 20s.). Let sit for 24±2 h at *room condition, then measure. <table border="1" style="margin-left: 20px;"> <thead> <tr> <th>Step</th> <th>1</th> <th>2</th> </tr> </thead> <tbody> <tr> <td>Temp. (°C)</td> <td>-55+0/-3</td> <td>125+3/-0</td> </tr> <tr> <td>Time (min.)</td> <td>15±3</td> <td>15±3</td> </tr> </tbody> </table>	Step	1	2	Temp. (°C)	-55+0/-3	125+3/-0	Time (min.)	15±3	15±3
		Step	1		2								
		Temp. (°C)	-55+0/-3		125+3/-0								
		Time (min.)	15±3		15±3								
Capacitance Change	Within ±5% or ±0.5pF (Whichever is larger)												
Q	30pF ≤ C : Q ≥ 350 10pF ≤ C < 30pF : Q ≥ 275+5C/2 10pF > C : Q ≥ 200+10C C : Nominal Capacitance (pF)												
I.R.	1,000MΩ or 50MΩ·μF min. (Whichever is smaller)												

* "room condition" Temperature:15 to 35°C, Relative humidity:45 to 75%, Atmosphere pressure:86 to 106kPa

Reference only

No.	AEC-Q200 Test Item	Specifications	AEC-Q200 Test Method												
15	ESD	Appearance	No defects or abnormalities												
		Capacitance	Within the specified tolerance												
		Q	$30\text{pF} \leq C : Q \geq 1,000$ $30\text{pF} > C : Q \geq 400+20C$ C : Nominal Capacitance (pF)												
		I.R.	More than 10,000MΩ or 500 MΩ·μF (Whichever is smaller)												
16	Solderability	Lead wire should be soldered with uniform coating on the axial direction over 95% of the circumferential direction.	Should be placed into steam aging for 8h±15 min. The terminal of capacitor is dipped into a solution of ethanol (JIS K 8101) and rosin (JIS K 5902) (25% rosin in weight proportion). Immerse in solder solution for 2±0.5 seconds. In both cases the depth of dipping is up to about 1.5 to 2mm from the terminal body. Temp. of solder : 245±5°C Lead Free Solder(Sn-3.0Ag-0.5Cu) 235±5°C H60A or H63A Eutectic Solder												
17	Electrical Characterization	Appearance	No defects or abnormalities												
		Capacitance	Within the specified tolerance												
		Q	$30\text{pF} \leq C : Q \geq 1,000$ $30\text{pF} > C : Q \geq 400+20C$ C : Nominal Capacitance (pF)												
		I.R.	Between Terminals 10,000MΩ or 500MΩ·μF min. (Whichever is smaller)												
		Dielectric Strength	Between Terminals No defects or abnormalities												
	Body Insulation	No defects or abnormalities													
18	Terminal Strength	Tensile Strength	Termination not to be broken or loosened												
		Bending Strength	Termination not to be broken or loosened												
19	Capacitance Temperature Characteristics	Within the specified Tolerance. $25^{\circ}\text{C} \sim 125^{\circ}\text{C} : -750 \pm 120 \text{ ppm}/^{\circ}\text{C}$ $-55^{\circ}\text{C} \sim 25^{\circ}\text{C} : -750 + 120 / -347 \text{ ppm}/^{\circ}\text{C}$	The capacitance change should be measured after 5min. at each specified temperature step. <table border="1" style="margin: 10px auto; border-collapse: collapse;"> <thead> <tr> <th>Step</th> <th>Temperature(°C)</th> </tr> </thead> <tbody> <tr> <td>1</td> <td>25±2</td> </tr> <tr> <td>2</td> <td>-55±3</td> </tr> <tr> <td>3</td> <td>25±2</td> </tr> <tr> <td>4</td> <td>125±3</td> </tr> <tr> <td>5</td> <td>25±2</td> </tr> </tbody> </table> The temperature coefficient is determined using the capacitance measured in step 3 as a reference. When cycling the temperature sequentially from step 1 through 5 (-55°C to +125°C) the capacitance should be within the specified tolerance for the temperature coefficient and capacitance change as Table A. The capacitance drift is calculated by dividing the differences between the maximum and minimum measured values in the step 1, 3 and 5 by the capacitance value in step 3.	Step	Temperature(°C)	1	25±2	2	-55±3	3	25±2	4	125±3	5	25±2
Step	Temperature(°C)														
1	25±2														
2	-55±3														
3	25±2														
4	125±3														
5	25±2														

* "room condition" Temperature: 15 to 35°C, Relative humidity: 45 to 75%, Atmosphere pressure: 86 to 106kPa

Reference only

6. Packing specification

- Bulk type (Packing style code : B)

The number of packing = $\frac{\text{Packing quantity}}{\text{Packing quantity}} \times n$

The size of packing case and packing way

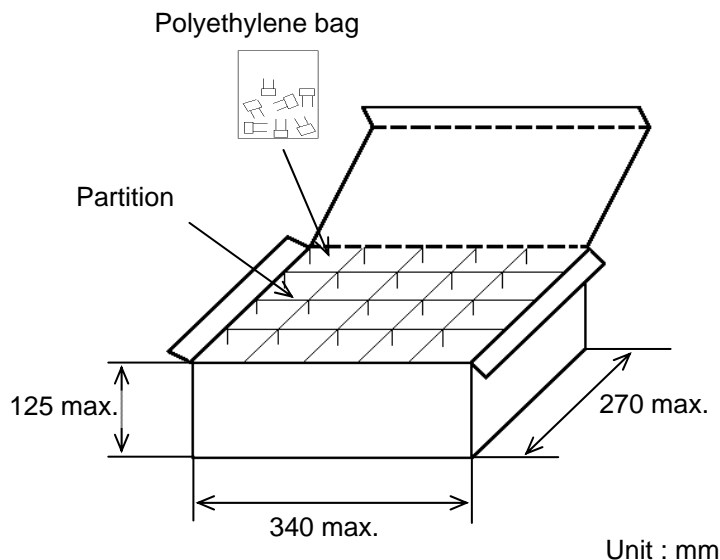

- *1 : Please refer to [Part number list].
- *2 : Standard n = 20 (bag)

Note)
The outer package and the number of outer packing be changed by the order getting amount.

- Ammo pack taping type (Packing style code : A)

- A crease is made every 25 pitches, and the tape with capacitors is packed zigzag into a case.
- When body of the capacitor is piled on other body under it.

The size of packing case and packing way

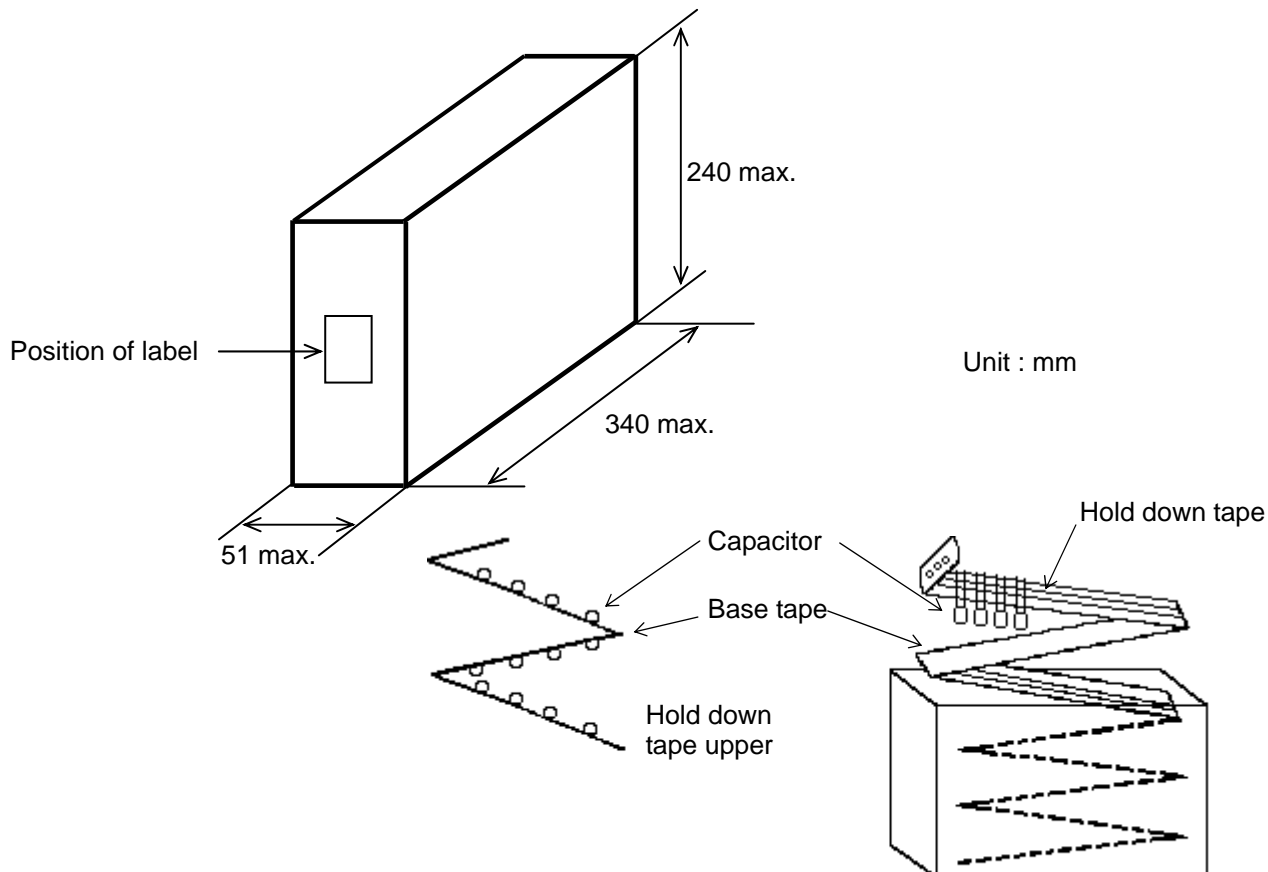

Reference only

7. Taping specification

7-1. Dimension of capacitors on tape

Straight taping type < Lead code : E1 >

Pitch of component 12.7mm / Lead spacing 5.0mm

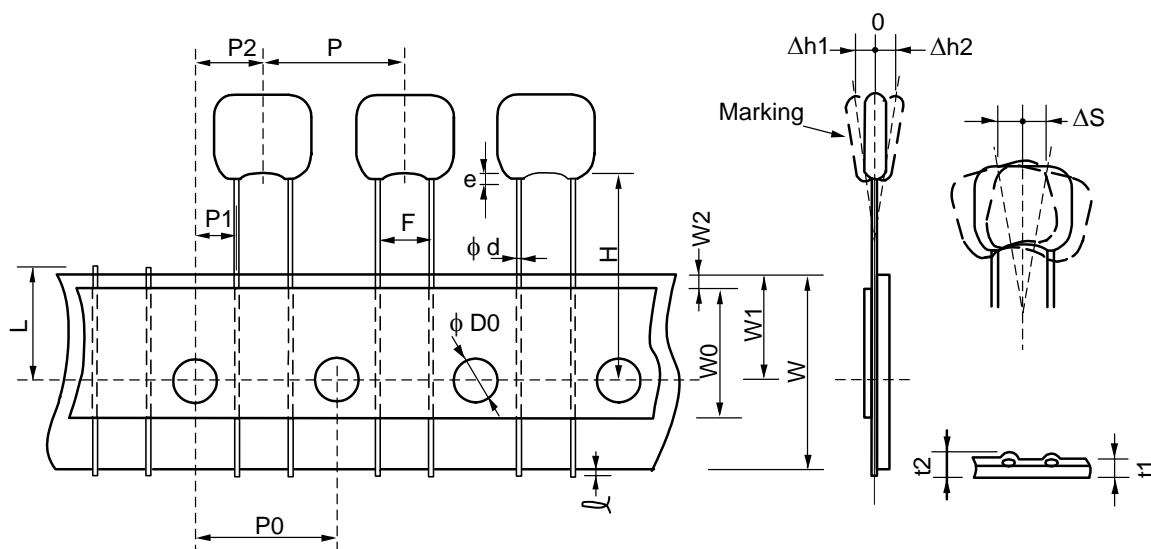

Unit : mm

Item	Code	Dimensions	Remarks
Pitch of component	P	12.7+/-1.0	
Pitch of sprocket hole	P0	12.7+/-0.2	
Lead spacing	F	5.0+0.6/-0.2	
Length from hole center to component center	P2	6.35+/-1.3	Deviation of progress direction
Length from hole center to lead	P1	3.85+/-0.7	
Deviation along tape, left or right defect	ΔS	0+/-2.0	They include deviation by lead bend .
Carrier tape width	W	18.0+/-0.5	
Position of sprocket hole	W1	9.0+0/-0.5	Deviation of tape width direction
For straight lead type	H	17.5+/-0.5	
Protrusion length	l	0.5 max.	
Diameter of sprocket hole	D0	4.0+/-0.1	
Lead diameter	ϕd	0.50+/-0.05	
Total tape thickness	$t1$	0.6+/-0.3	They include hold down tape thickness.
Total thickness of tape and lead wire	$t2$	1.5 max.	
Deviation across tape	$\Delta h1$	2.0 max. (Dimension code : U)	
	$\Delta h2$	1.0 max. (except as above)	
Portion to cut in case of defect	L	11.0+0/-1.0	
Hold down tape width	W0	9.5 min.	
Hold down tape position	W2	1.5+/-1.5	
Coating extension on lead	e	2.0 max. (Dimension code : U)	
		1.5 max. (except as above)	

Reference only

Inside crimp taping type < Lead code : M1 >
Pitch of component 12.7mm / Lead spacing 5.0mm

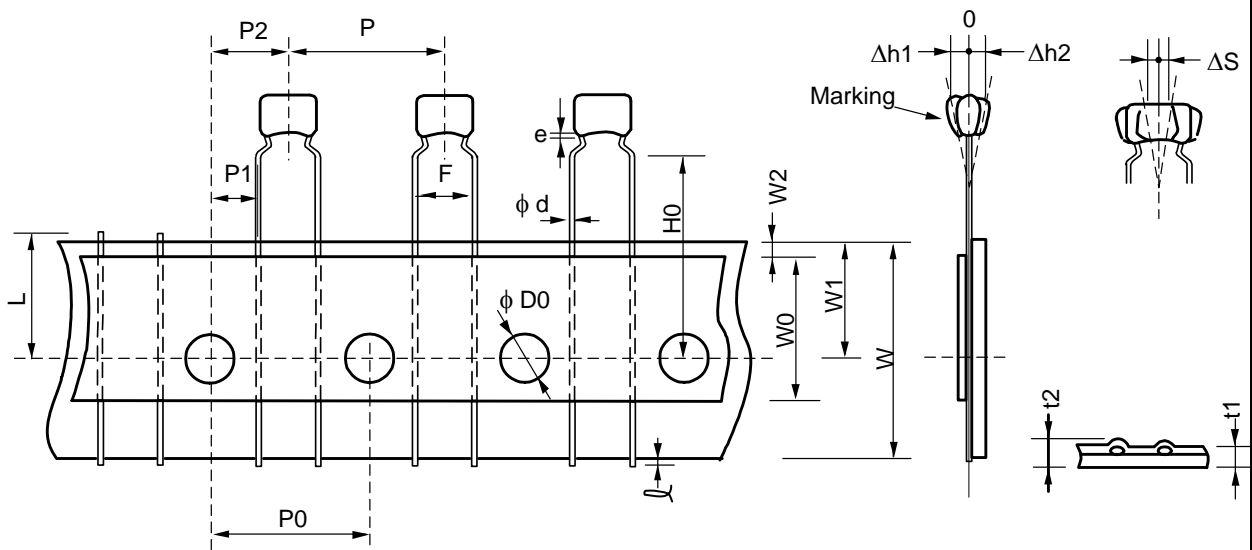

Unit : mm

Item	Code	Dimensions	Remarks
Pitch of component	P	12.7+/-1.0	
Pitch of sprocket hole	P0	12.7+/-0.2	
Lead spacing	F	5.0+0.6/-0.2	
Length from hole center to component center	P2	6.35+/-1.3	Deviation of progress direction
Length from hole center to lead	P1	3.85+/-0.7	
Deviation along tape, left or right defect	ΔS	0+/-2.0	They include deviation by lead bend .
Carrier tape width	W	18.0+/-0.5	
Position of sprocket hole	W1	9.0+0/-0.5	Deviation of tape width direction
Lead distance between reference and bottom plane	H0	16.0+/-0.5	
Protrusion length	ℓ	0.5 max.	
Diameter of sprocket hole	D0	4.0+/-0.1	
Lead diameter	φd	0.50+/-0.05	
Total tape thickness	t1	0.6+/-0.3	They include hold down tape thickness.
Total thickness of tape and lead wire	t2	1.5 max.	
Deviation across tape	Δh1	2.0 max. (Dimension code : W)	
	Δh2	1.0 max. (except as above)	
Portion to cut in case of defect	L	11.0+0/-1.0	
Hold down tape width	W0	9.5 min.	
Hold down tape position	W2	1.5+/-1.5	
Coating extension on lead	e	Up to the end of crimp	

Reference only

7-2. Splicing way of tape

- 1) Adhesive force of tape is over 3N at test condition as below.

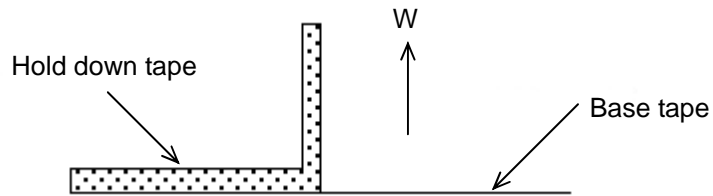

2) Splicing of tape

- a) When base tape is spliced

- Base tape shall be spliced by cellophane tape.
(Total tape thickness shall be less than 1.05mm.)

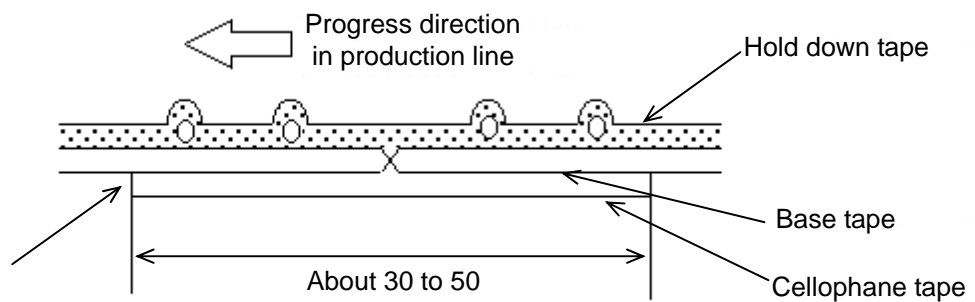

No lifting for the direction of progressing

Unit : mm

- b) When hold down tape is spliced

- Hold down tape shall be spliced with overlapping.
(Total tape thickness shall be less than 1.05mm.)

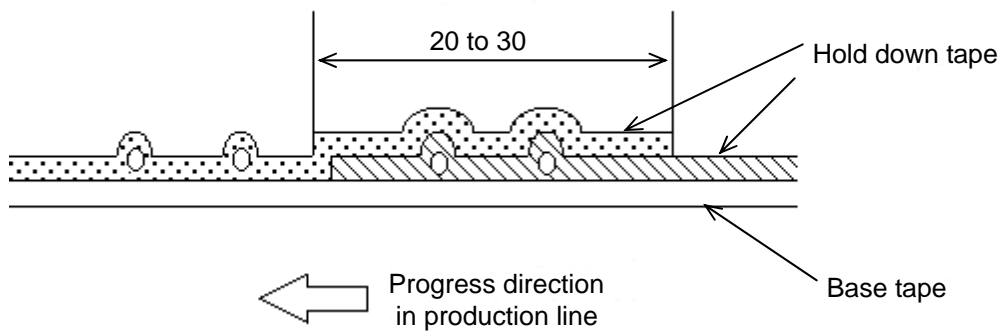

Unit : mm

- c) When both tape are spliced

- Base tape and hold down tape shall be spliced with splicing tape.

EU RoHS and Halogen Free

This products of the following crresponds to EU RoHS and Halogen Free

(1) RoHS

EU RoHs 2011/65/EC compliance

maximum concentration values tolerated by weight in homogeneous materials

- 1000 ppm maximum Lead
- 1000 ppm maximum Mercury
- 100 ppm maximum Cadmium
- 1000 ppm maximum Hexavalent chromium
- 1000 ppm maximum Polybrominated biphenyls (PBB)
- 1000 ppm maximum Polybrominated diphenyl ethers (PBDE)

(2) Halogen-Free

The International Electrochemical Commission's (IEC) Definition of Halogen-Free (IEC 61249-2-21) compliance

- 900 ppm maximum chlorine
- 900 ppm maximum bromine
- 1500 ppm maximum total chlorine and bromine

Mouser Electronics

Authorized Distributor

Click to View Pricing, Inventory, Delivery & Lifecycle Information:

Murata:

[RCE7U2E101J1K1H03B](#) [RCE7U2E101J1M1H03A](#) [RCE7U2E102J1K1H03B](#) [RCE7U2E102J1M1H03A](#)
[RCE7U2E103J2K1H03B](#) [RCE7U2E103J2M1H03A](#) [RCE7U2E151J1K1H03B](#) [RCE7U2E151J1M1H03A](#)
[RCE7U2E152J1K1H03B](#) [RCE7U2E152J1M1H03A](#) [RCE7U2E221J1K1H03B](#) [RCE7U2E221J1M1H03A](#)
[RCE7U2E222J1K1H03B](#) [RCE7U2E222J1M1H03A](#) [RCE7U2E331J1K1H03B](#) [RCE7U2E331J1M1H03A](#)
[RCE7U2E332J1K1H03B](#) [RCE7U2E332J1M1H03A](#) [RCE7U2E471J1K1H03B](#) [RCE7U2E471J1M1H03A](#)
[RCE7U2E472J1K1H03B](#) [RCE7U2E472J1M1H03A](#) [RCE7U2E681J1K1H03B](#) [RCE7U2E681J1M1H03A](#)
[RCE7U2E682J2K1H03B](#) [RCE7U2E682J2M1H03A](#) [RCE7U2J100J2K1H03B](#) [RCE7U2J100J2M1H03A](#)
[RCE7U2J101J2K1H03B](#) [RCE7U2J101J2M1H03A](#) [RCE7U2J102J2K1H03B](#) [RCE7U2J102J2M1H03A](#)
[RCE7U2J103J3K1H03B](#) [RCE7U2J103J3M1H03A](#) [RCE7U2J150J2K1H03B](#) [RCE7U2J150J2M1H03A](#)
[RCE7U2J151J2K1H03B](#) [RCE7U2J151J2M1H03A](#) [RCE7U2J152J2K1H03B](#) [RCE7U2J152J2M1H03A](#)
[RCE7U2J153J4K1H03B](#) [RCE7U2J153J4M1H03A](#) [RCE7U2J220J2K1H03B](#) [RCE7U2J220J2M1H03A](#)
[RCE7U2J221J2K1H03B](#) [RCE7U2J221J2M1H03A](#) [RCE7U2J222J2K1H03B](#) [RCE7U2J222J2M1H03A](#)
[RCE7U2J223J4K1H03B](#) [RCE7U2J223J4M1H03A](#) [RCE7U2J330J2K1H03B](#) [RCE7U2J330J2M1H03A](#)
[RCE7U2J331J2K1H03B](#) [RCE7U2J331J2M1H03A](#) [RCE7U2J332J2K1H03B](#) [RCE7U2J332J2M1H03A](#)
[RCE7U2J333J5B1H03B](#) [RCE7U2J333J5E1H03A](#) [RCE7U2J470J2K1H03B](#) [RCE7U2J470J2M1H03A](#)
[RCE7U2J471J2K1H03B](#) [RCE7U2J471J2M1H03A](#) [RCE7U2J472J2K1H03B](#) [RCE7U2J472J2M1H03A](#)
[RCE7U2J473J5B1H03B](#) [RCE7U2J473J5E1H03A](#) [RCE7U2J680J2K1H03B](#) [RCE7U2J680J2M1H03A](#)
[RCE7U2J681J2K1H03B](#) [RCE7U2J681J2M1H03A](#) [RCE7U2J682J3K1H03B](#) [RCE7U2J682J3M1H03A](#)
[RCE7U2J943JUB1H03B](#) [RCE7U2J943JUE1H03A](#) [RCE7U3A100J2K1H03B](#) [RCE7U3A100J2M1H03A](#)
[RCE7U3A101J2K1H03B](#) [RCE7U3A101J2M1H03A](#) [RCE7U3A102J2K1H03B](#) [RCE7U3A102J2M1H03A](#)
[RCE7U3A103J5B1H03B](#) [RCE7U3A103J5E1H03A](#) [RCE7U3A150J2K1H03B](#) [RCE7U3A150J2M1H03A](#)
[RCE7U3A151J2K1H03B](#) [RCE7U3A151J2M1H03A](#) [RCE7U3A152J3K1H03B](#) [RCE7U3A152J3M1H03A](#)
[RCE7U3A203JUB1H03B](#) [RCE7U3A203JUE1H03A](#) [RCE7U3A220J2K1H03B](#) [RCE7U3A220J2M1H03A](#)
[RCE7U3A221J2K1H03B](#) [RCE7U3A221J2M1H03A](#) [RCE7U3A222J3K1H03B](#) [RCE7U3A222J3M1H03A](#)
[RCE7U3A330J2K1H03B](#) [RCE7U3A330J2M1H03A](#) [RCE7U3A331J2K1H03B](#) [RCE7U3A331J2M1H03A](#)