

## SMT PHEMT LOW NOISE AMPLIFIER, 0.3 - 3.0 GHz



### Typical Applications

The HMC374 / HMC374E is ideal for:

- Cellular/PCS/3G
- WCS, MMDS & ISM
- Fixed Wireless & WLAN
- Private Land Mobile Radio

### Features

- Single Supply: Vdd = +2.75 to +5.5V
- Low Noise Figure: 1.5 dB
- High Output IP3: +37 dBm
- No External Matching Required

### Functional Diagram

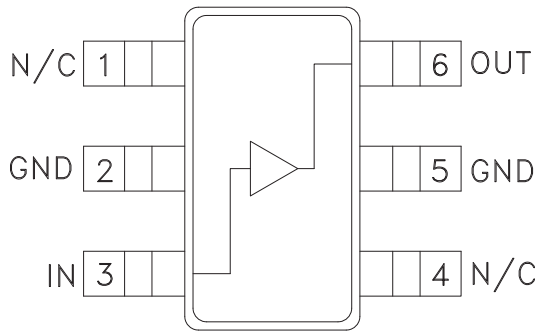

### General Description

The HMC374 & HMC374E are general purpose broad band Low Noise Amplifiers (LNA) for use in the 0.3 - 3 GHz frequency range. The LNA provides 15 dB of gain and a 1.5 dB noise figure from a single positive supply of +2.75 to +5.5V. The low noise figure coupled with a high P1dB (22 dBm) and high OIP3 (37 dBm) make this part ideal for cellular applications. The compact LNA design utilizes on-chip matching for repeatable gain and noise figure performance. To minimize board area the design is offered in a low cost SOT26 package that occupies only 0.118" x 0.118".

### Electrical Specifications, $T_A = +25^\circ C$ , Vdd = +5V

| Parameter                                     | Min.      | Typ. | Max. | Min.      | Typ. | Max. | Min.      | Typ. | Max. | Units |
|---|-----------|------|------|-----------|------|------|-----------|------|------|-------|
| Frequency Range                               | 0.3 - 1.0 |      |      | 1.0 - 2.0 |      |      | 2.0 - 3.0 |      |      | GHz   |
| Gain  | 12        | 15   |      | 10        | 13   |      | 6         | 9    |      | dB    |
| Gain Variation Over Temperature               |           | 0.01 | 0.02 |           | 0.01 | 0.02 |           | 0.01 | 0.02 | dB/°C |
| Noise Figure                                  |           | 1.5  | 1.9  |           | 1.6  | 2.0  |           | 1.8  | 2.2  | dB    |
| Input Return Loss                             |           | 5    |      |           | 8    |      |           | 13   |      | dB    |
| Output Return Loss                            |           | 7    |      |           | 9    |      |           | 9    |      | dB    |
| Output 1 dB Compression (P1dB)                |           | 22   |      |           | 22   |      |           | 22   |      | dBm   |
| Saturated Output Power (P <sub>sat</sub> )    |           | 23   |      |           | 23   |      |           | 23   |      | dBm   |
| Output Third Order Intercept (IP3)            |           | 37   |      |           | 37   |      |           | 37   |      | dBm   |
| Supply Current (I <sub>dd</sub> ) (Vdd = +5V) |           | 90   |      |           | 90   |      |           | 90   |      | mA    |

Information furnished by Analog Devices is believed to be accurate and reliable. However, no responsibility is assumed by Analog Devices for its use, nor for any infringements of patents or other rights of third parties that may result from its use. Specifications subject to change without notice. No license is granted by implication or otherwise under any patent or patent rights of Analog Devices. Trademarks and registered trademarks are the property of their respective owners.

For price, delivery, and to place orders: Analog Devices, Inc., One Technology Way, P.O. Box 9106, Norwood, MA 02062-9106 Phone: 781-329-4700 • Order online at [www.analog.com](http://www.analog.com) Application Support: Phone: 1-800-ANALOG-D



**SMT PHEMT LOW NOISE  
AMPLIFIER, 0.3 - 3.0 GHz**

**Broadband Gain & Return Loss**

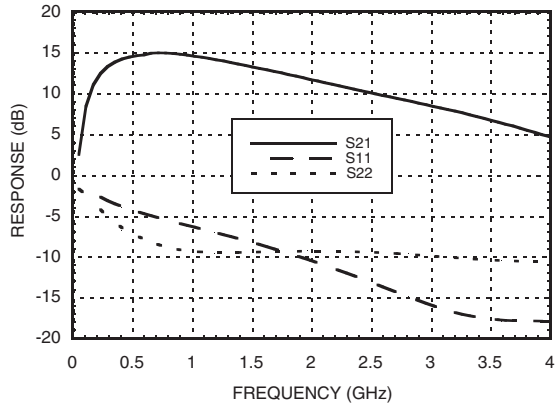

**Gain vs. Temperature**

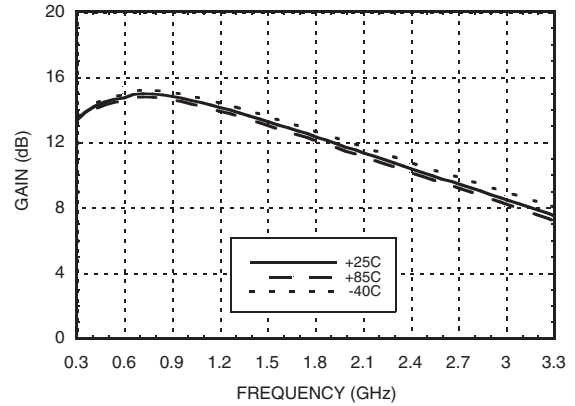

**Input Return Loss vs. Temperature**

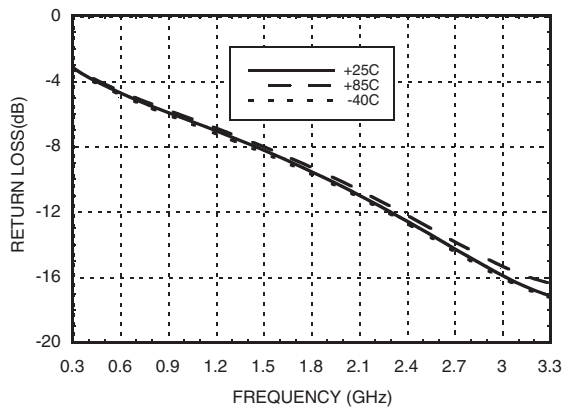

**Output Return Loss vs. Temperature**

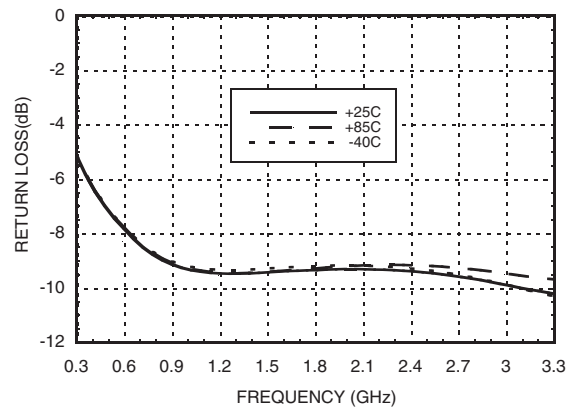

**Noise Figure vs. Temperature**

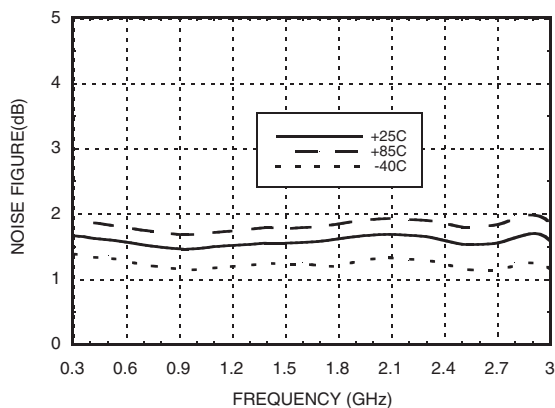

**Output IP3 vs. Temperature**

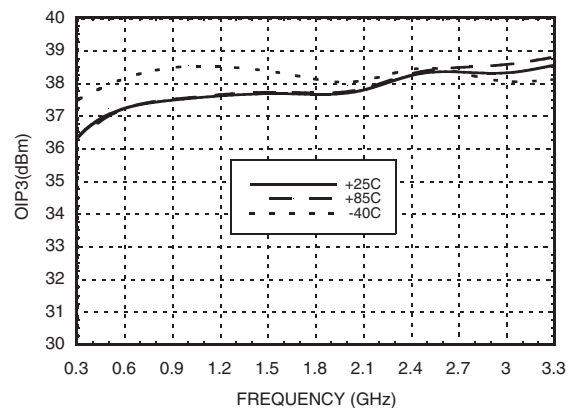

Information furnished by Analog Devices is believed to be accurate and reliable. However, no responsibility is assumed by Analog Devices for its use, nor for any infringements of patents or other rights of third parties that may result from its use. Specifications subject to change without notice. No license is granted by implication or otherwise under any patent or patent rights of Analog Devices. Trademarks and registered trademarks are the property of their respective owners.

For price, delivery, and to place orders: Analog Devices, Inc., One Technology Way, P.O. Box 9106, Norwood, MA 02062-9106 Phone: 781-329-4700 • Order online at [www.analog.com](http://www.analog.com) Application Support: Phone: 1-800-ANALOG-D



**SMT PHEMT LOW NOISE AMPLIFIER, 0.3 - 3.0 GHz**

LOW NOISE AMPLIFIERS - SMT 8

**P1dB vs. Temperature**

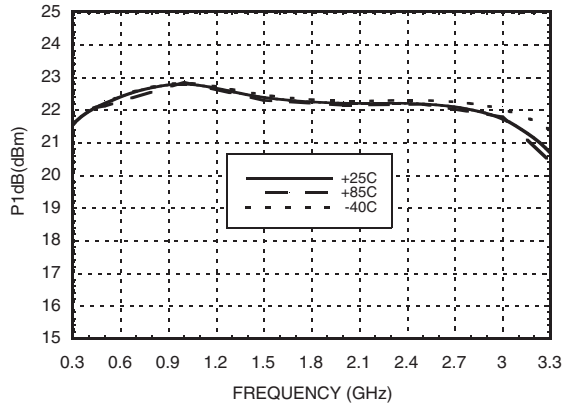

**Psat vs. Temperature**

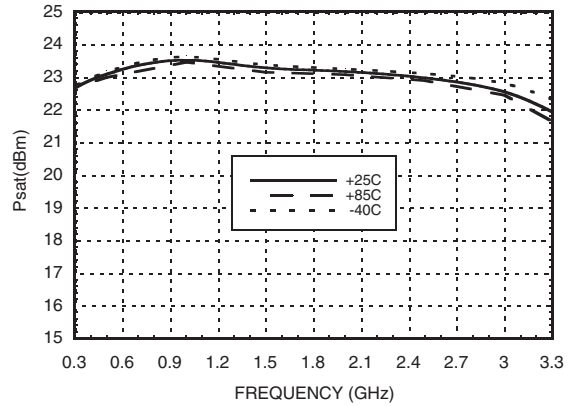

**Reverse Isolation vs. Temperature**

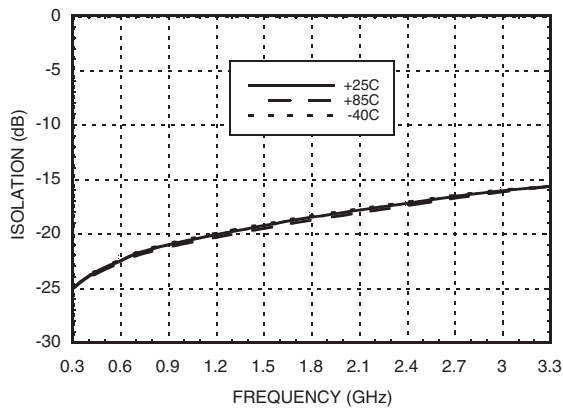

**Power Compression @ 2 GHz**

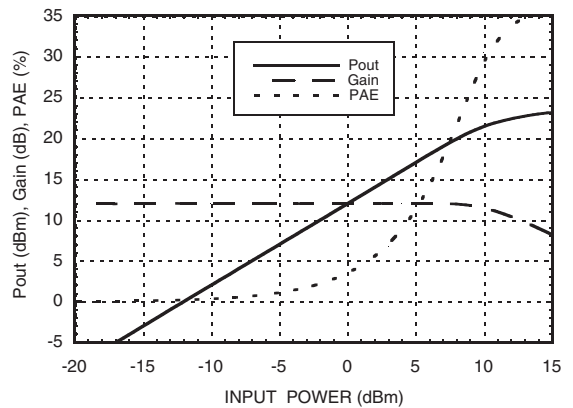

**Gain, Noise Figure & Power vs. Supply Voltage @ 2 GHz**

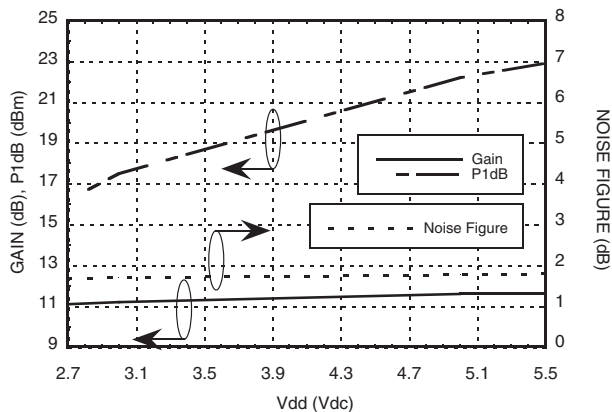

**Current vs. Power @ 2 GHz**

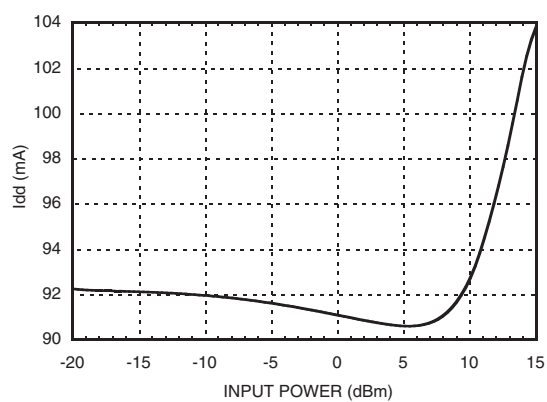

Information furnished by Analog Devices is believed to be accurate and reliable. However, no responsibility is assumed by Analog Devices for its use, nor for any infringements of patents or other rights of third parties that may result from its use. Specifications subject to change without notice. No license is granted by implication or otherwise under any patent or patent rights of Analog Devices. Trademarks and registered trademarks are the property of their respective owners.

For price, delivery, and to place orders: Analog Devices, Inc., One Technology Way, P.O. Box 9106, Norwood, MA 02062-9106 Phone: 781-329-4700 • Order online at [www.analog.com](http://www.analog.com) Application Support: Phone: 1-800-ANALOG-D



## SMT PHEMT LOW NOISE AMPLIFIER, 0.3 - 3.0 GHz

### Absolute Maximum Ratings

|  |                |
|--|----------------|
| Drain Bias Voltage (Vdd)                                       | +7.0 Vdc       |
| RF Input Power (RFIN)(Vdd = +5.0 Vdc)                          | 15 dBm         |
| Channel Temperature  | 150 °C         |
| Continuous Pdiss (T = 85 °C)<br>(derate 7.5 mW/°C above 85 °C) | 0.488 W        |
| Thermal Resistance<br>(channel to lead)                        | 133 °C/W       |
| Storage Temperature  | -65 to +150 °C |
| Operating Temperature  | -40 to +85 °C  |

### Typical Supply Current vs. Vdd

| Vdd (V) | Idd (mA) |
|---------|----------|
| 2.7     | 89       |
| 3.0     | 89       |
| 5.0     | 90       |
| 5.5     | 90       |



ELECTROSTATIC SENSITIVE DEVICE  
OBSERVE HANDLING PRECAUTIONS

### Outline Drawing

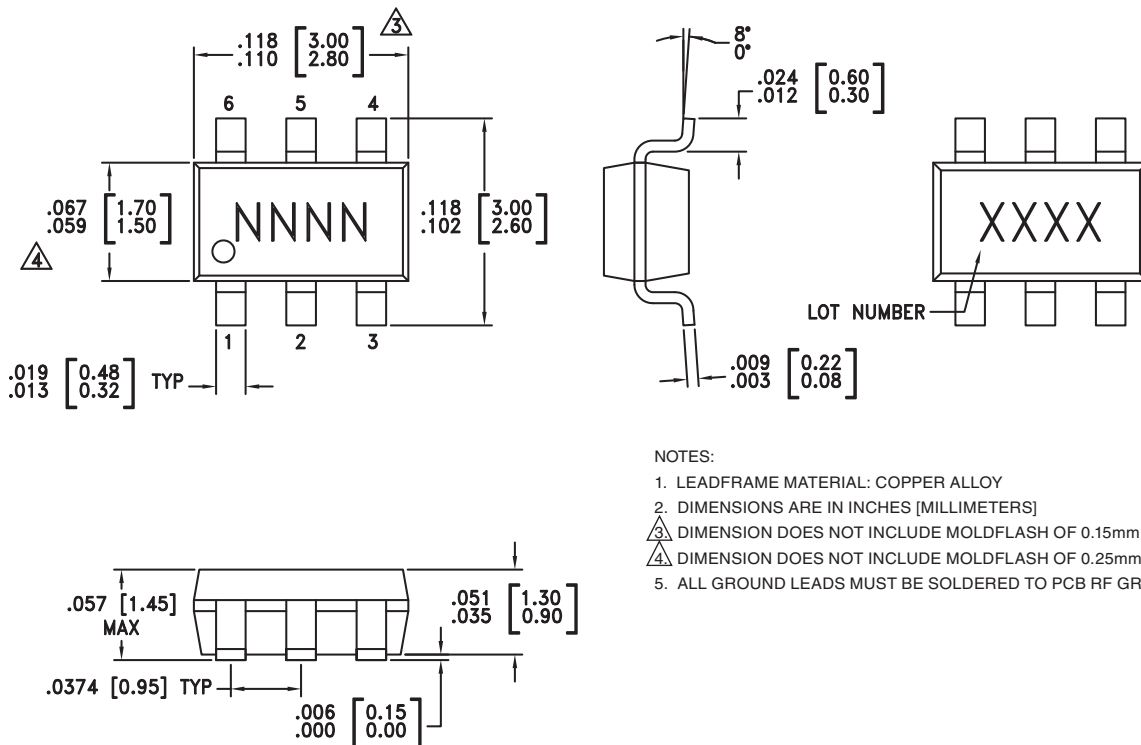

NOTES:

1. LEADFRAME MATERIAL: COPPER ALLOY
2. DIMENSIONS ARE IN INCHES [MILLIMETERS]
3. DIMENSION DOES NOT INCLUDE MOLDFLASH OF 0.15mm PER SIDE.
4. DIMENSION DOES NOT INCLUDE MOLDFLASH OF 0.25mm PER SIDE.
5. ALL GROUND LEADS MUST BE SOLDERED TO PCB RF GROUND.

### Package Information

| Part Number | Package Body Material                               | Lead Finish   | MSL Rating          | Package Marking <sup>[3]</sup> |
|-------------|---|---------------|---------------------|--------------------------------|
| HMC374      | Low Stress Injection Molding Plastic                | Sn/Pb Solder  | MSL1 <sup>[1]</sup> | H374<br>XXXX                   |
| HMC374E     | RoHS-compliant Low Stress Injection Molding Plastic | 100% matte Sn | MSL1 <sup>[2]</sup> | 374E<br>XXXX                   |

[1] Max peak reflow temperature of 235 °C

[2] Max peak reflow temperature of 260 °C

[3] 4-Digit lot number XXXX



**SMT PHEMT LOW NOISE  
AMPLIFIER, 0.3 - 3.0 GHz**

**Pin Descriptions**

| Pin Number | Function | Description  | Interface Schematic |
|------------|----------|--|---------------------|
| 1,4        | N/C      | These pins may be connected to RF/DC ground. Performance will not be affected.               |                     |
| 2, 5       | GND      | These pins must be connected to RF/DC ground.  |                     |
| 3          | IN       | This pin is DC coupled. An off-chip DC blocking capacitor is required.                       |                     |
| 6          | OUT      | RF output and DC Bias for the output stage. See application circuit for off-chip components. |                     |

**Application Circuit**

| Recommended Component Values |             |
|------------------------------|-------------|
| C1, C2                       | 150 pF      |
| C3                           | 1,000 pF    |
| C4                           | 4.7 $\mu$ F |
| L1                           | 27 nH       |

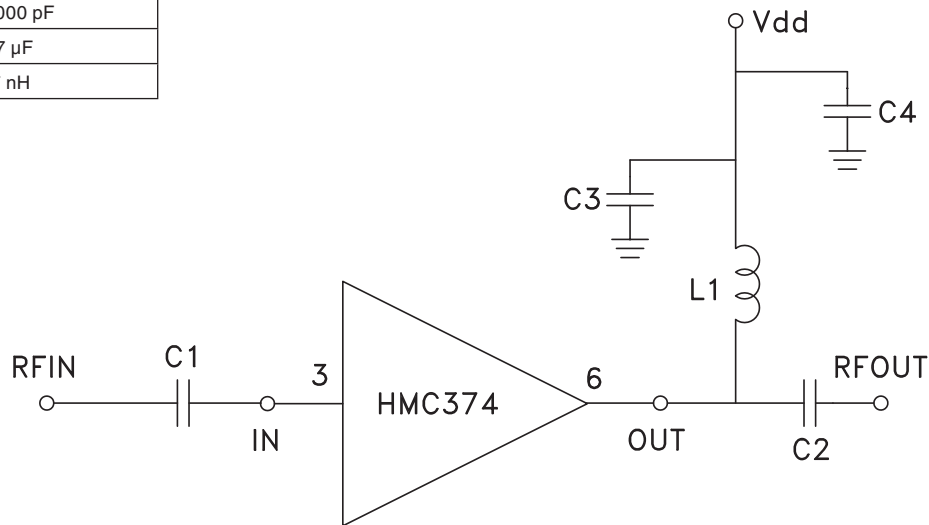

Information furnished by Analog Devices is believed to be accurate and reliable. However, no responsibility is assumed by Analog Devices for its use, nor for any infringements of patents or other rights of third parties that may result from its use. Specifications subject to change without notice. No license is granted by implication or otherwise under any patent or patent rights of Analog Devices. Trademarks and registered trademarks are the property of their respective owners.

For price, delivery, and to place orders: Analog Devices, Inc., One Technology Way, P.O. Box 9106, Norwood, MA 02062-9106 Phone: 781-329-4700 • Order online at [www.analog.com](http://www.analog.com) Application Support: Phone: 1-800-ANALOG-D



**Evaluation PCB**

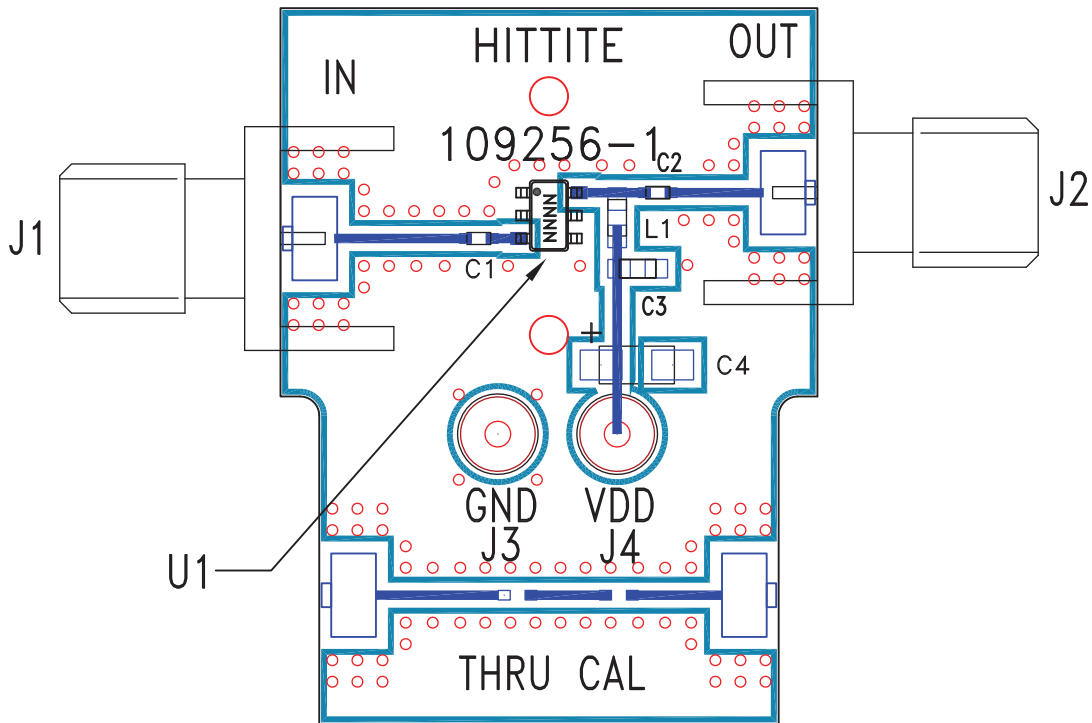

**List of Materials for Evaluation PCB 109258 [1]**

| Item    | Description                  |
|---------|------------------------------|
| J1, J2  | PCB Mount SMA Connector      |
| J3, J4  | DC Pin                       |
| C1, C2  | 150 pF Capacitor, 0402 Pkg.  |
| C3      | 1000 pF Capacitor, 0603 Pkg. |
| C4      | 4.7 Capacitor, Tantalum      |
| L1      | 27 nH Inductor, 0603 Pkg.    |
| U1      | HMC374 / HMC374E Amplifier   |
| PCB [2] | 109256 Evaluation PCB        |

[1] Reference this number when ordering complete evaluation PCB

[2] Circuit Board Material: Roger 4350

The circuit board used in the final application should use RF circuit design techniques. Signal lines should have 50 ohm impedance while the package ground leads should be connected directly to the ground plane similar to that shown above. A sufficient number of via holes should be used to connect the top and bottom ground planes. The evaluation circuit board shown is available from Hittite upon request.

# Mouser Electronics

Authorized Distributor

Click to View Pricing, Inventory, Delivery & Lifecycle Information:

[Analog Devices Inc.:](#)

[HMC374E](#) [HMC374](#) [109258-HMC374](#) [HMC374ETR](#)