

M3



ERC

Feed-through terminal, Screw connection, Mounting type: Mounting rail TS 35/7.5, Rated cross-section: 4 mm², Width: 6 mm, Colour: Beige

Business data

Packaging unit	80
Quantity unit	PC
Weight per piece (not including packaging)	10.2 g
Weight per piece (including packaging)	11.1 g
Unit of weight	G
Customs number	85369010
Country of origin	DE
Product description	Feed-through terminal

Technical data

Dimensions

Length	62.5 mm
Width	6 mm
Height TS 35/7.5	47 mm

Ratings

Rated voltage	400 V
Rated current	32 A
Current load, max.	41 A
Rated cross-section	4 mm ²
Rated impulse voltage	8 kV
Overvoltage category	III
Contamination degree	3
Maximum power dissipation for nominal condition	1.02 W

Technical data

Connection data

Connection principle	Screw connection
Connection position	Lateral
Connections	4
Special connection	Spade flat plug Faston 2.8 mm
Number of terminals per level	2
Number of levels	1
Wire cross-section single-core (rigid) / stranded, min.	0.2 mm ²
Wire cross-section single core (rigid)/stranded, max.	6 mm ²
Wire cross-section stranded, min.	0.2 mm ²
Wire cross-section stranded, max.	6 mm ²
Wire cross-section stranded with wire-end ferrules, min.	0.2 mm ²
Wire cross-section stranded with wire-end ferrules, max.	4 mm ²
Wire cross-section AWG, min.	26
Wire cross-section AWG, max.	10
Stripping length	10 mm
Screw head	Slotted
Screw threading	M 3
Tightening torque, min.	0.5 Nm
Tightening torque, max.	1 Nm

Materials

Insulation housing	Polyamide 6.6
Flammability class UL 94	V-0
Working temperature, min.	-40 °C
Working temperature, max.	120 °C

Technical data

Further technical data

Mounting type	Mounting rail TS 35/7,5
Gauge plug acc. to EN 60 947-1	A4
Number of cross-connection channels	2
End plate required	✓
Number of test pick-off options	1

Print

Colour	Beige
--------	-------

Environmental Product Compliance

REACH Conform	yes
REACH Reference date	2021-07-08
REACH Candidate Substance Note	No
RoHS Conform	yes

Approvals

Standards and regulations

EAC approval	TR ZU 004/2011
--------------	----------------

EAC approval granted	yes
----------------------	-----

German Lloyd approval

GL approval	IEC 60947-7-1:2009
-------------	--------------------

GL approval granted	yes
---------------------	-----

GL rated voltage	1000 V
------------------	--------

GL rated current	41 A
------------------	------

GL rated cross-section	4 mm ²
------------------------	-------------------

GL rated impulse voltage	8 kV
--------------------------	------

GL environmental category	C
---------------------------	---

Media

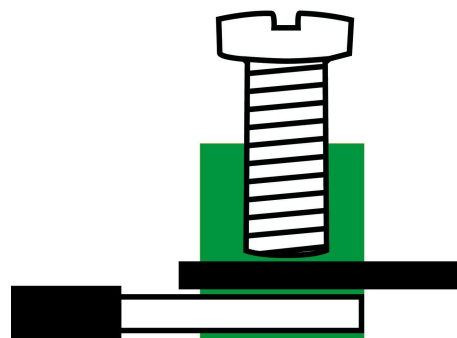
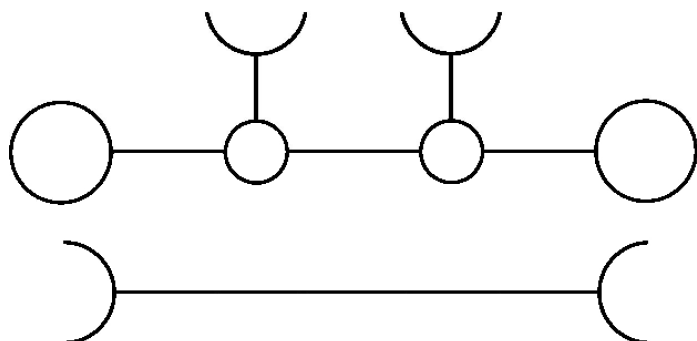

M3

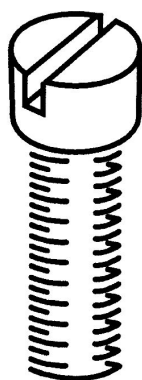

EAC

17116.2

SRK 4/2A SAS BG

Accessories

Cover

Cover, Width: 6 mm, Colour: Yellow



detail.dataSheet.generalOrderData

Product number:	detail.dataSheet.productName	GTIN (EAN)	detail.dataSheet.
17296.8	SAD 1/6/B YE	4044211205447	500 ST

Measurement pick-off terminal



Measurement pick-off terminal, Screw connection, Mounting type: On base, Rated cross-section: 2.5 mm², Width: 5.9 mm, Colour: Beige

detail.dataSheet.generalOrderData

Product number:	detail.dataSheet.productName	GTIN (EAN)	detail.dataSheet.
17120.2	SMAG 4/2,5 BG	4044211172107	500 ST

17116.2

SRK 4/2A SAS BG

Accessories

End plate

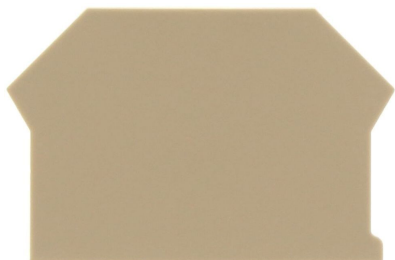

End plate, Width: 1.5 mm, Colour: Beige

detail.dataSheet.generalOrderData

Product number:	detail.dataSheet.productName	GTIN (EAN)	detail.dataSheet.
2001.2	AP 2,5-10 BG	4044211047979	500 ST

End stop



End stop, Mounting type: Mounting rail TS 35/7.5 and TS 35/15, Width: 8 mm, Colour: Beige

detail.dataSheet.generalOrderData

Product number:	detail.dataSheet.productName	GTIN (EAN)	detail.dataSheet.
17250.2	SES 35 BG	4044211178253	500 ST

17116.2

SRK 4/2A SAS BG

Accessories

Insulation cap for cross-connector



Insulating cap, Colour: Yellow

detail.dataSheet.generalOrderData

Product number:	detail.dataSheet.productName	GTIN (EAN)	detail.dataSheet.
17200.8	SQIK 2,5-10 YE	4044211148539	500 ST

Insulated cross-connector



Insulated cross-connector, No. of poles: 3,
Mounting type: Plug in, Width: 17.4 mm,
Rated cross-section: 4 mm², Colour: Yellow

detail.dataSheet.generalOrderData

Product number:	detail.dataSheet.productName	GTIN (EAN)	detail.dataSheet.
17212.8	SQI 4/3 YE	4044211148652	500 ST

17116.2

SRK 4/2A SAS BG

Accessories

Quick marking

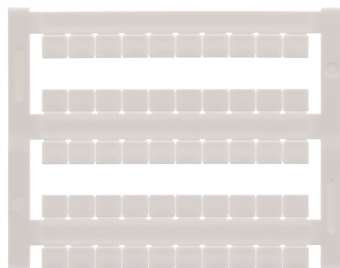

Terminal marker / Pocket Maxicard, Length: 5 mm, Width: 6 mm, Colour: White

detail.dataSheet.generalOrderData

Product number:	detail.dataSheet.productName	GTIN (EAN)	detail.dataSheet.
4702.7	PMC SB 6/50 WH	4044211089986	500 ST

Screwdriver



Screwdriver with bare blade, Colour: Black-grey

detail.dataSheet.generalOrderData

Product number:	detail.dataSheet.productName	GTIN (EAN)	detail.dataSheet.
1086.0	SDB 0,6x3,5	4044211014797	500 ST

17116.2

SRK 4/2A SAS BG

Accessories

Test adapters

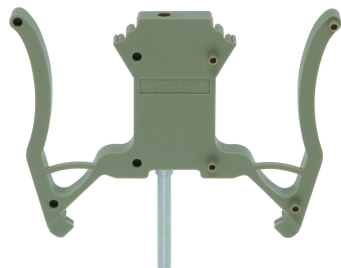

Test adapter, Length: 70 mm, Pitch size: 5 mm, Colour: Beige

detail.dataSheet.generalOrderData

Product number:	detail.dataSheet.productName	GTIN (EAN)	detail.dataSheet.
17260.2	STA 5/1 BG	4044211171599	500 ST

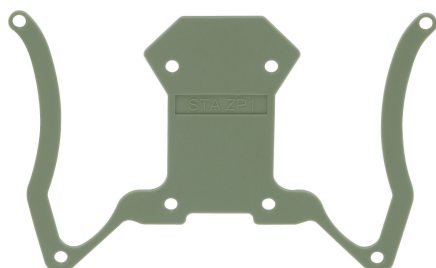

Test adapter, Length: 70 mm, Pitch size: 1 mm, Colour: Beige

detail.dataSheet.generalOrderData

Product number:	detail.dataSheet.productName	GTIN (EAN)	detail.dataSheet.
17261.2	STA ZP1 BG	4044211171605	500 ST