



Assembly Instruction of **X-lok Field Installable Connectors**

Revision 03
2020-04-15

X-Lok Field Installable | Installation Instruction | Components Overview

Female Connector

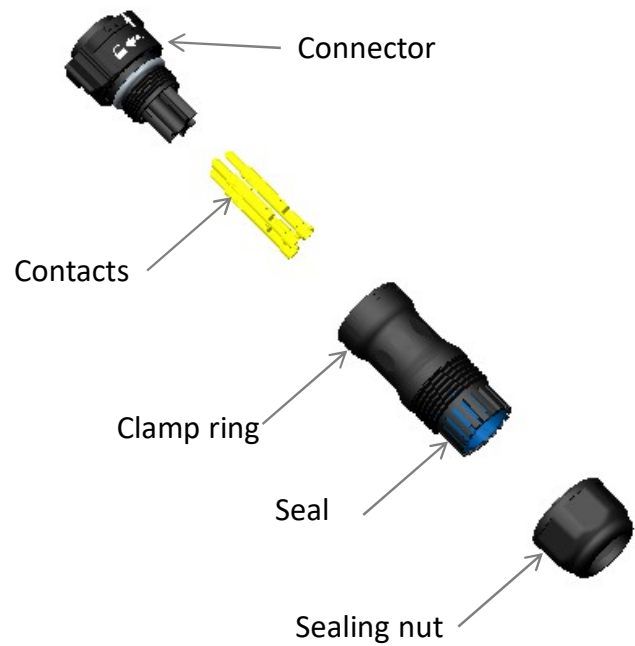

Male Connector

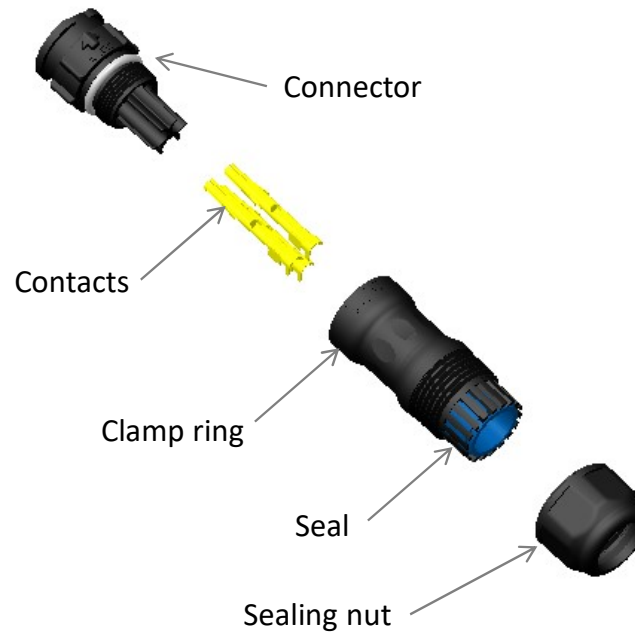

Contact Packaging Options

Loose in Bulk

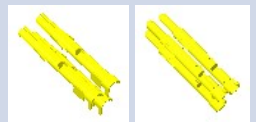

Reel



X-Lok Field Installable | Installation Instruction | Cable Installation

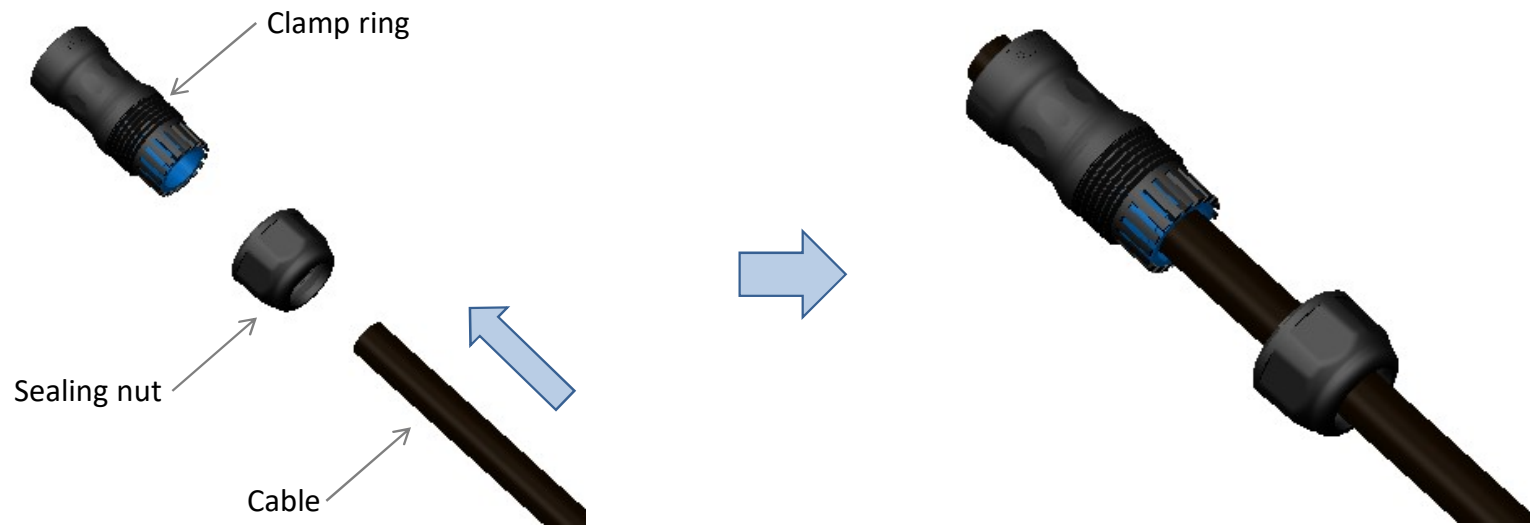

1. Insert the stripped cable through sealing nut

2. Then, insert the stripped cable through clamp ring

X-Lok Field Installable | Installation Instruction | Cable Jacket and Insulator Stripping

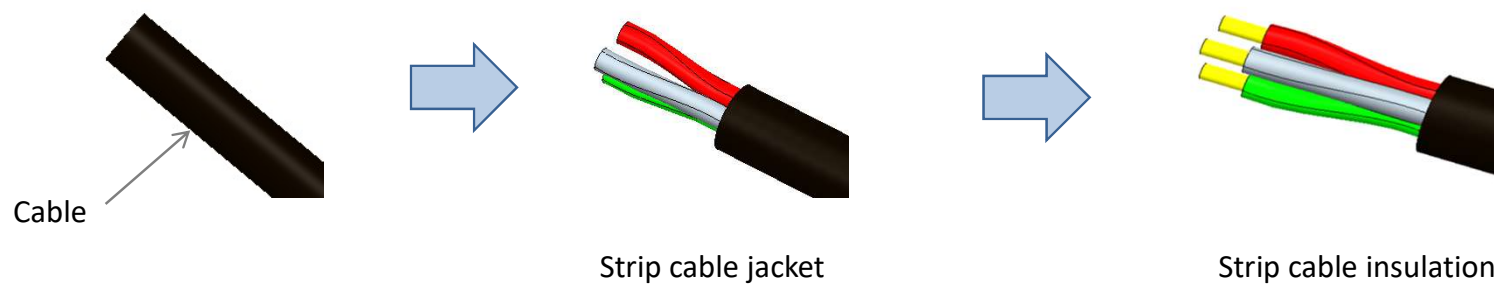

Cable Processing Instruction

Terminal Type	Strip Insulation Length (A)	Strip Jacket Length (B)
5A	3.5 ~ 4	16 ~ 18
10A	5 ~ 5.5	16 ~ 18
20A	5 ~ 5.5	18 ~ 20

Unit : mm

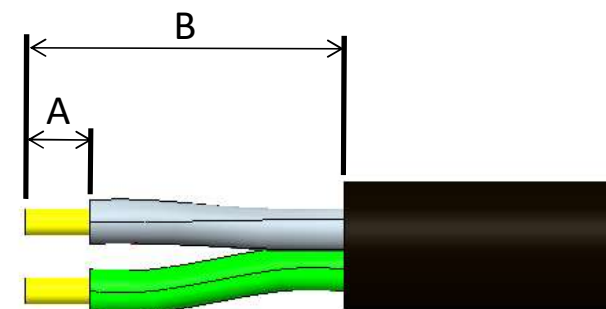

注意:未依照線材加工尺寸，線材與Seal結合不正確，會產生防水功能失效。

Note: Please follow above cable processing instruction . Waterproof failure may occur due to incorrect wire and seal assembly .

X-Lok Field Installable | Installation Instruction | Visual Checking the Exposed Conductor

Perform a Visual Quality Check to stripped cable jacket and insulation

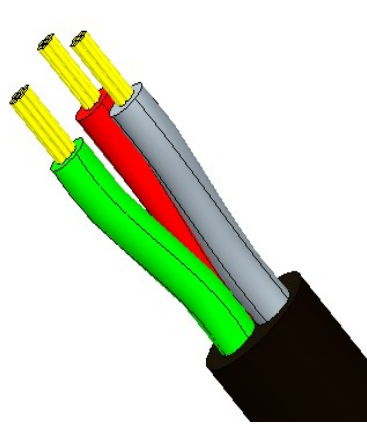

Good

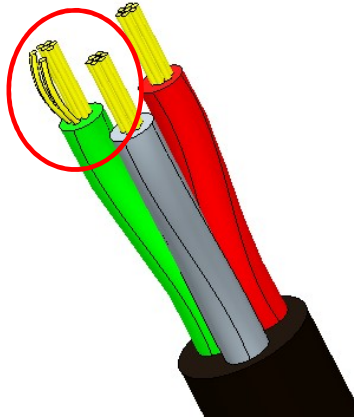

NG

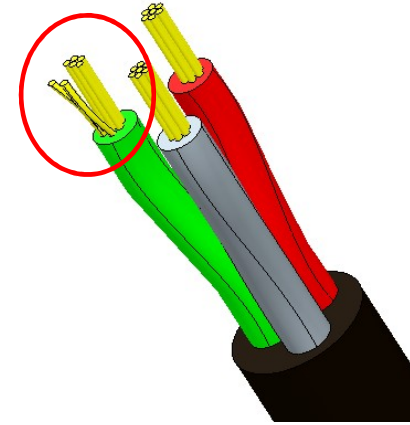

NG

X-Lok Field Installable | Installation Instruction | Crimping Process

Option 1: Manual Crimping



Push crimp contact into opening of crimping tool

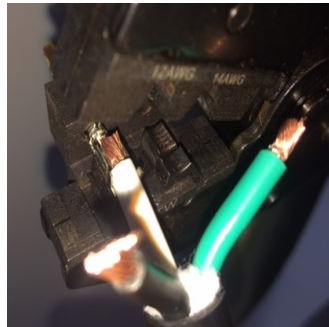

Insert stripped wire into the funnel shaped end of the crimp contact



Squeeze handles of crimping tool together and connect contact to wire

Terminal Type	Tool No.
5A	ASST-C-05-W-A
10A	ASST-C-10-W-B
20A	ASST-C-20-W-C

Manual Crimping Tool Variants

Option 2: Auto - Crimping



Load the reel of contacts to crimping machine



Push crimp contact into opening of crimping machine

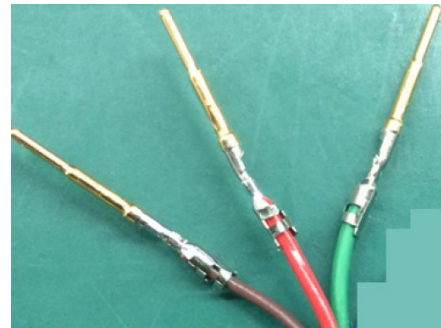

Visual check for proper termination

X-Lok Field Installable | Installation Instruction | Contact Installation to Housing.

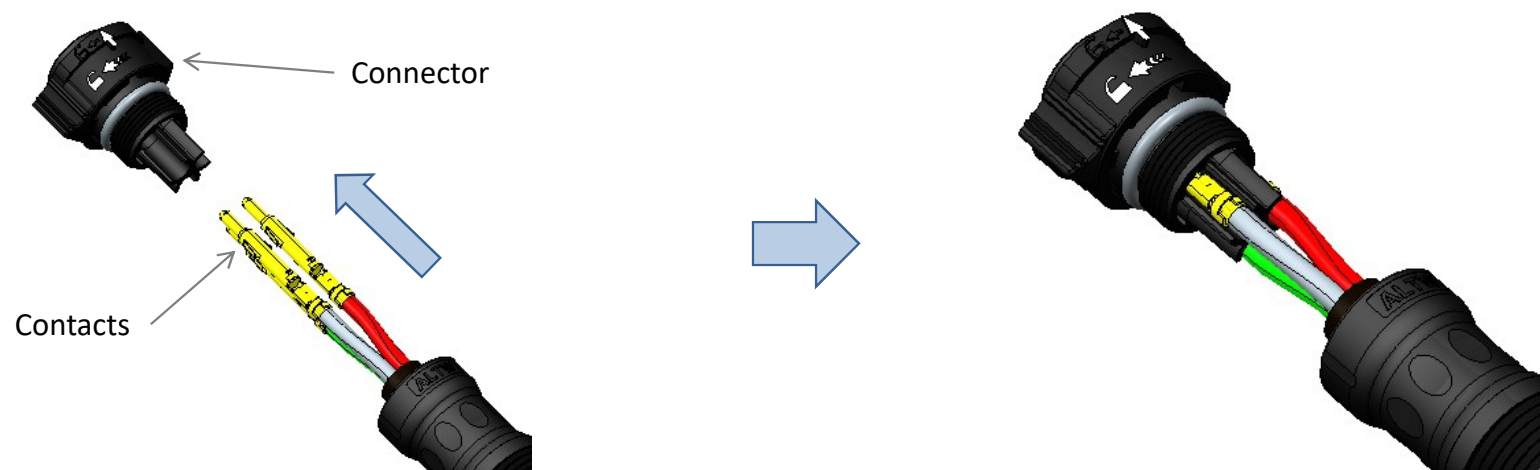

After placing the conductors to contact, push it to housing until you hear the tick sound. Make sure that the correct conductor is placed in its assigned slot.

注意：端子安裝後，不可以退出。請依據需求wire 顏色，安裝到適當孔。

Note: Once conductor is assembled, disassembly is not allowed. Please cross check the wire color with contact before assembly.

X-Lok Field Installable | Installation Instruction | Visual Checking the Installed Contacts

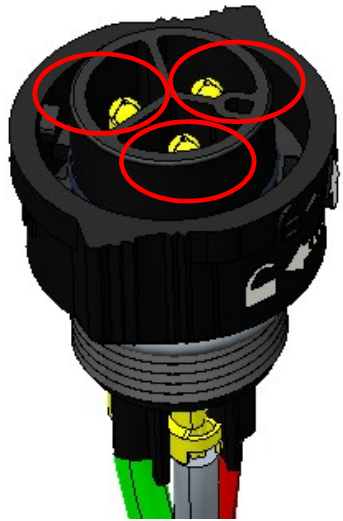

Good

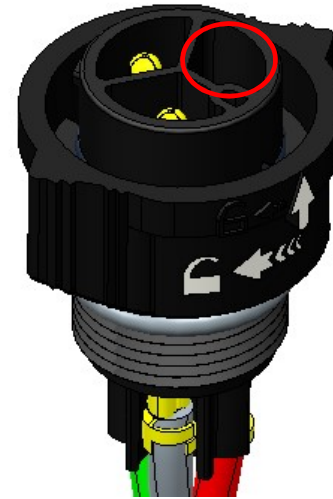

NG

Perform a quick Visual Quality check after inserting the contacts to Housing.

X-Lok Field Installable | Installation Instruction | Clamp Ring Installation

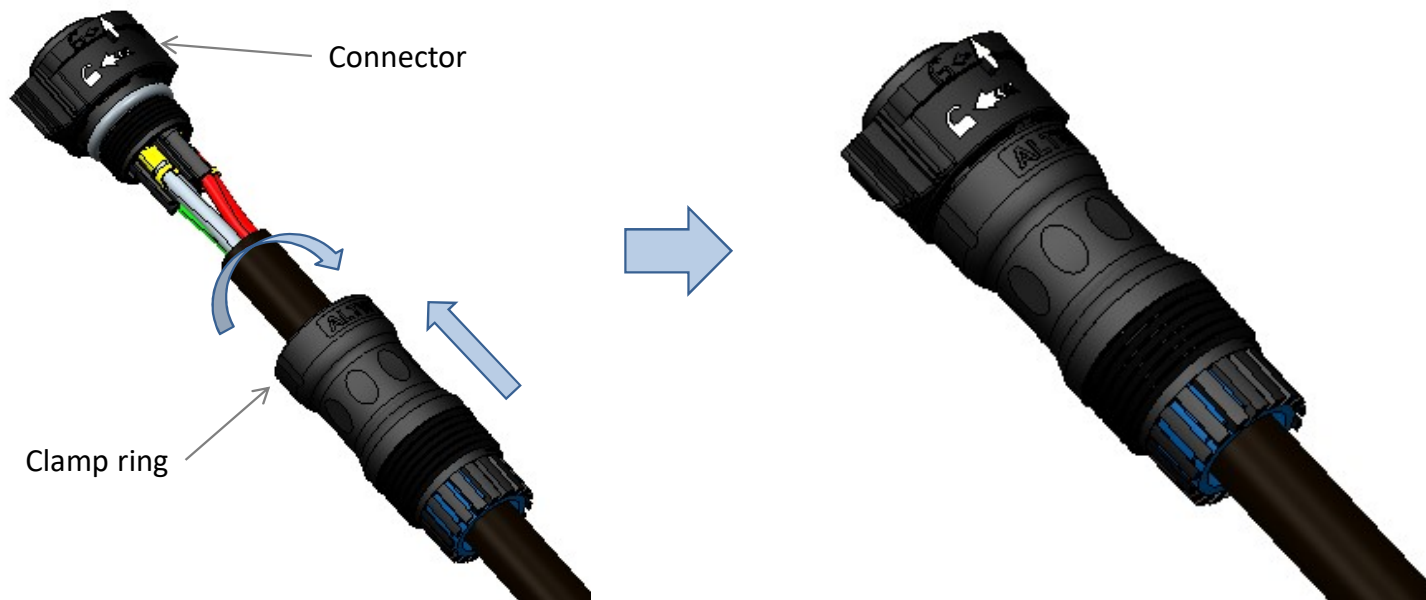

Install the Clamp Ring to Housing-with-Contacts by Screwing. Make sure to observe the proper torsional force.

Clamping Ring Torque: 6 ~ 8kgf.cm(0.58 ~ 0.78N.m)

X-Lok Field Installable | Installation Instruction | Visual Checking the Clamp Ring Installation

Good

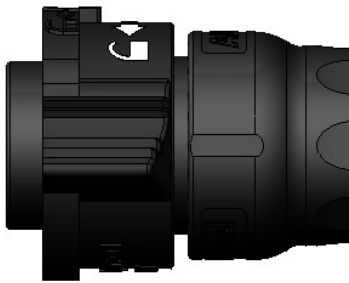

O-Ring between
Housing and Clamp
Ring is hidden.

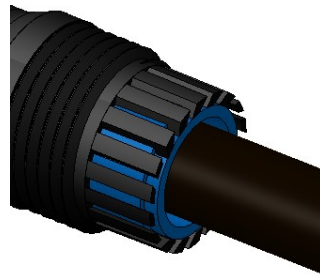

Seal aligns the
Clamp Ring surface

NG

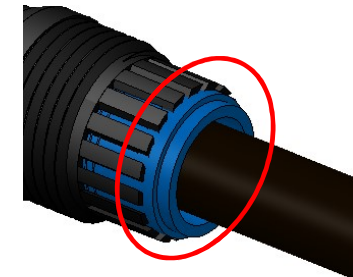
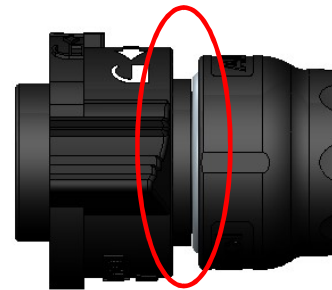

X-Lok Field Installable | Installation Instruction | Sealing Nut Installation

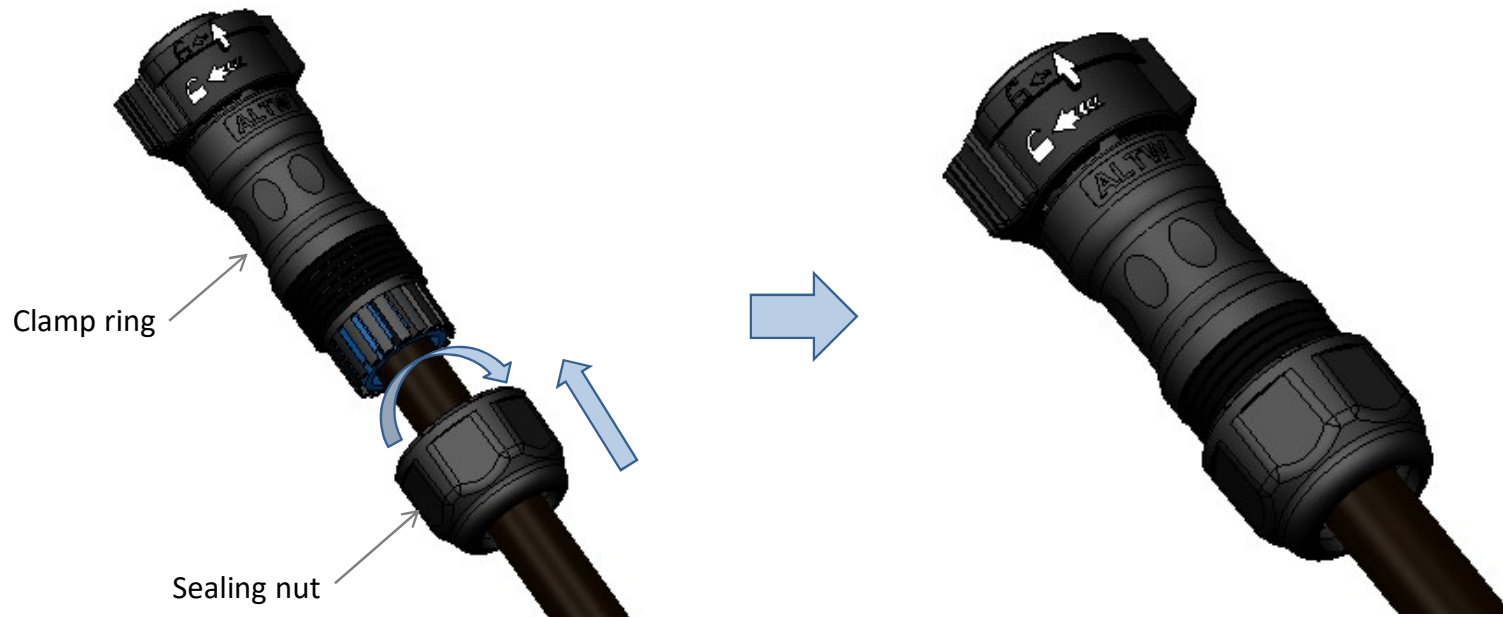

Install the Sealing Nut to Clamp Ring by Screwing. Make sure to observe the proper torsional force.

Sealing Nut Torque: 6 ~ 8kgf.cm(0.58 ~ 0.78N.m)

X-Lok Field Installable | Installation Instruction | Recommendation on Wires and Conductors

Contact Range and dimensions

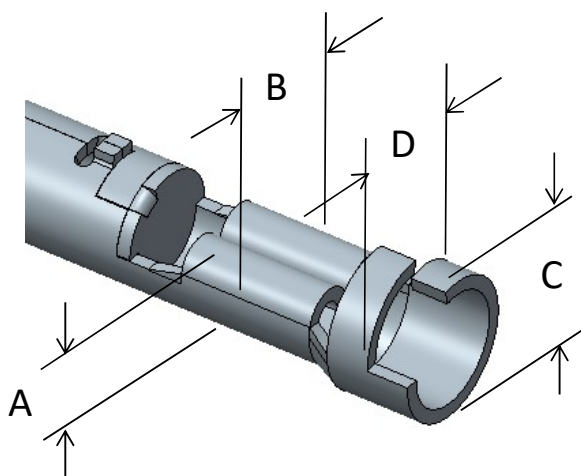

Terminal Type	Wire AWG	Conductor clip		Insulation clip	
		High(A)	Width(B)	High(C)	Width(D)
5A	22AWG	0.95	1.60	NA	NA
	20AWG	1.05	1.60	NA	NA
10A	18AWG	1.60	2.30	2.30	2.90
	16AWG	1.80	2.35	2.75	2.90
20A	14AWG	2.35	3.50	3.80	4.00
	12AWG	2.70	3.60	4.20	4.20

Unit : mm









Terminal Type	Wire AWG	Test tension Kg
5A	22#	3.6
	20#	4.5
10A	18#	4.5
	16#	6.8
20A	14#	11.3
	12#	15.9

注意：未依照尺寸加工，會影響電流傳輸效能。建議購改標準工具。

Note: Conduction performance, conductivity, may be effected with incorrect assembly. If using manual installation it is recommended to purchase the ALTW standard tool.

X-Lok Field Installable | Installation Instruction | Seal Selection Guide

Seal usage information

Type	Color	Max Cable OD	Min Cable OD
B Size		6.0mm	5.0mm
		8.0mm	6.0mm
		10.0mm	8.0mm
C Size		8.0mm	6.0mm
		10.0mm	8.0mm
		12.0mm	10.0mm
D Size		10.0mm	8.0mm
		12.0mm	10.0mm
		14.0mm	12.0mm

注意:選擇不適當Seal，防水性能會降低或失效。Cable OD 過大，會產生Cable 不容易穿過Seal

Note: Inappropriate choice of seal will lead the waterproof failure. Oversized cable OD will be difficult to pass through the seal.

X-Lok Field Installable | Installation Instruction | Cable Selection Guide

Cable Jacketing Type

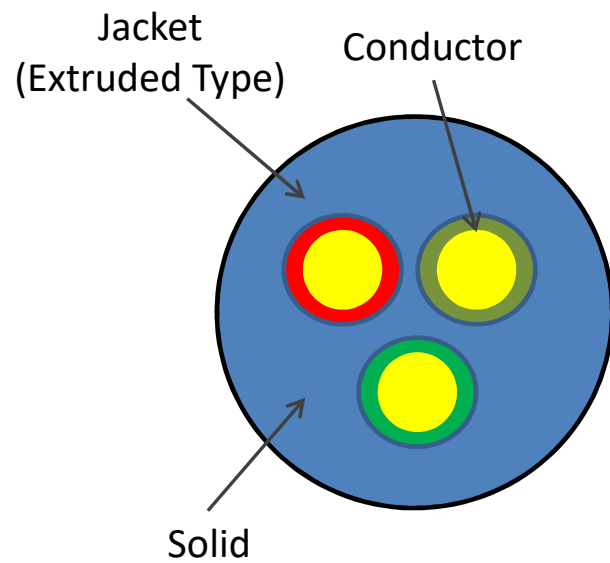

Good

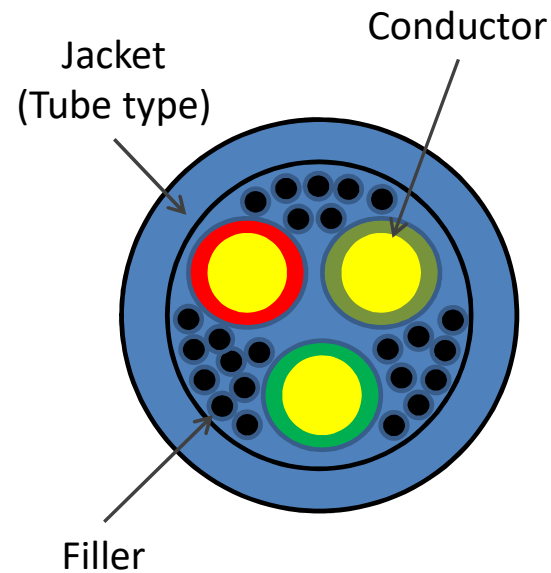

NG

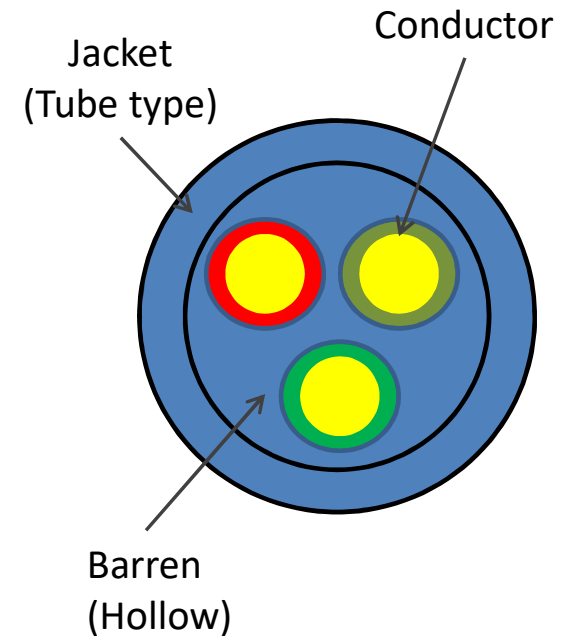

NG

注意:選擇不適當Cable 規格，防水性能會降低或失效。
Note: Inappropriate choice of cable will lead the waterproof failure.

X-Lok Field Installable | Installation Instruction | Coupling Information

Proper Mating

外觀上面符號對準，連接器需要平行對插。
Align the arrow symbol and mate the connector in parallel.

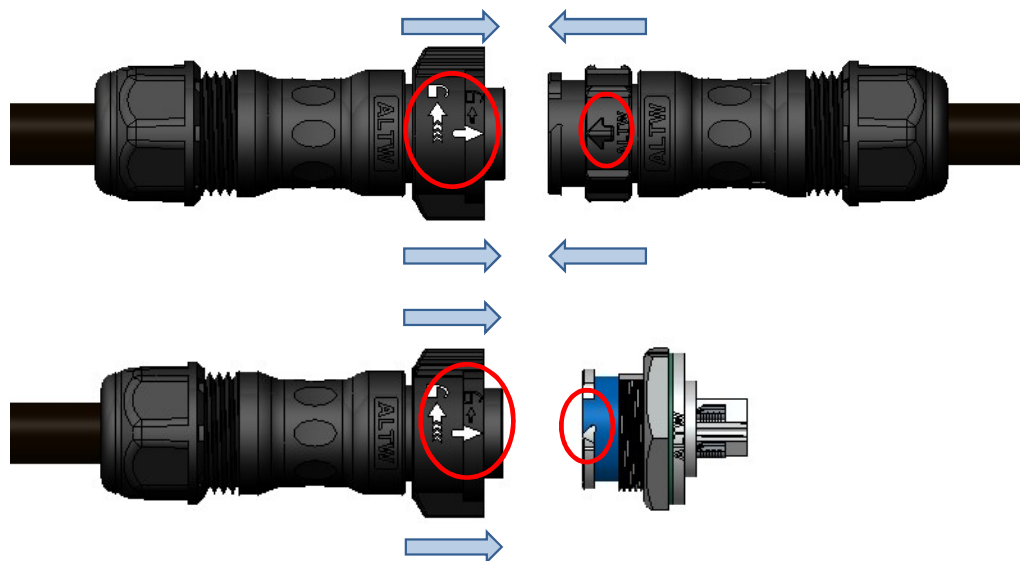

Improper Mating

不可以將連接器非平行對插。
Do not mating the connector non-parallel.

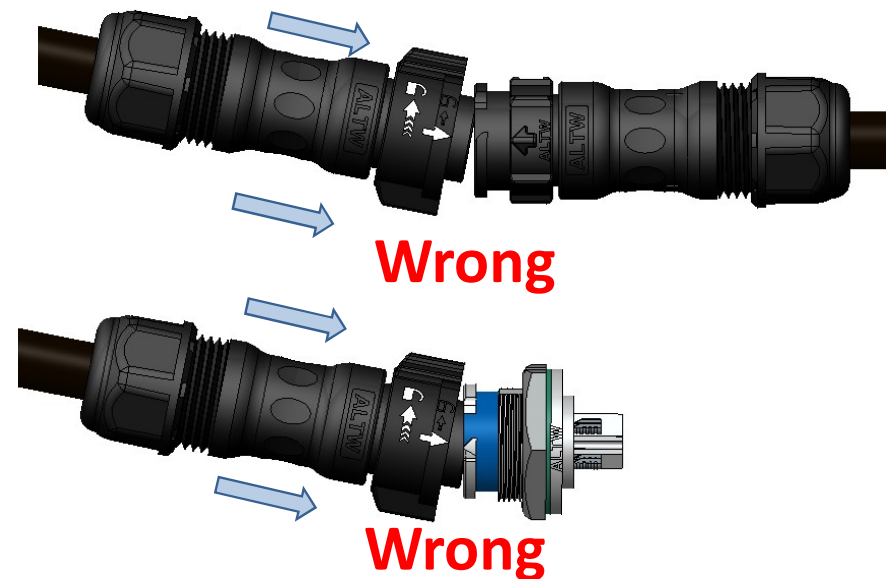

X-Lok Field Installable | Installation Instruction | Product Care

Additional guidelines of product usage:

1. 戶外使用，請增加適當輔具固定，增加產品可靠度。
1. For outdoor use, please add appropriate accessories to increase product reliability.
2. 於高樓層戶外應用，需使用輔具固定，並免風吹時，造成產品晃動，降低產品使用壽命。
2. For outdoor applications on high floors, it is necessary to use auxiliary equipment to fix and avoid wind blowing, which causes product shaking and reduces product life.
3. 產品應用，請對準Key點後，再進行對插。
3. For product application, please align the Key point and then insert it.

Mouser Electronics

Authorized Distributor

Click to View Pricing, Inventory, Delivery & Lifecycle Information:

[Amphenol:](#)

[ASST-C-10-W-B](#) [ASST-C-05-W-A](#) [ASST-C-20-W-C](#)