



TAOGLAS®



Datasheet

915MHz Embedded Patch Antenna with Cable and Connector

Part No:
ISPC.91A.09.0092E

Description

5dBi ISM Band 915MHz Embedded Ceramic Patch Antenna with Cable and Connector

Features:

- High antenna efficiency
- 902MHz to 928MHz ISM Band
- 5dBi Peak (when placed on 30*30cm ground plane)
- 2dBi Peak Gain in free-space
- 47*47*6.5 mm (Ceramic Antenna)
- 49.5*49.5*7.5 mm (Antenna with EVB)
- RG178 92mm cable length
- MMCX male Right Angle Connector
- RoHS & Reach Compliant

1.	Introduction	2
2.	Specification	3
3.	Antenna Characteristics	4
4.	Radiation Patterns	8
5.	Mechanical Drawing	11
6.	Packaging	12
7.	Application Note	13
<hr/>		
	Changelog	17

Taoglas makes no warranties based on the accuracy or completeness of the contents of this document and reserves the right to make changes to specifications and product descriptions at any time without notice. Taoglas reserves all rights to this document and the information contained herein. Reproduction, use or disclosure to third parties without express permission is strictly prohibited.



1. Introduction



The 5dBi ISPC.91A embedded ceramic patch antenna with cable and connector is designed primarily for ISM band 915MHz compact fixed wireless applications where it can be mounted to a metal panel to function as ground underneath the antenna.

When placed on a reference 30cm square ground-plane, the antenna has excellent directional hemispherical radiation pattern up to 5dBi on the zenith, and an efficiency of 73%.

Even without a ground-plane underneath the antenna achieves 2dBi and an efficiency of 66% at 915MHz, with an omni-directional pattern.

Coming as standard with a RG178 cable and MMCX male right angle connector it is a great solution for the following typical applications

- RFID Readers
- Short range 915MHz mesh networks

Cable type, length and connector can be customized. Mechanical customization of the antenna can also be done for a minimum order quantity. Please contact your regional Taoglas office for more details.

2. Specification

Electrical									
Band	Frequency (MHz)	Measurement	Efficiency (%)	Average Gain (dB)	Peak Gain (dBi)	Impedance	Polarization	Radiation Pattern	Max. input power
ISM	915	Free Space	57.1	-2.43	3.18	50 Ω	RHCP	Broadside Towards Zenith	5W
		Ground Plane 30x30	55.6	-2.55	5.88				

Dimension (mm)	
Material	Ceramic
Product Dimension (mm)	49.5*49.5*7.5
Coaxial Cable	RG178
Coaxial Length (mm)	92
Connector	MMCX Male Right Angle

Environmental	
Operation Temperature	-40°C to 85°C
Storage Temperature	-40°C to 105°C
Relative Humidity	40% to 95%
RoHS Compliant	Yes
Moisture Sensitivity Level	3 (168 Hours)

3. Antenna Characteristics

3.1 Test Setup

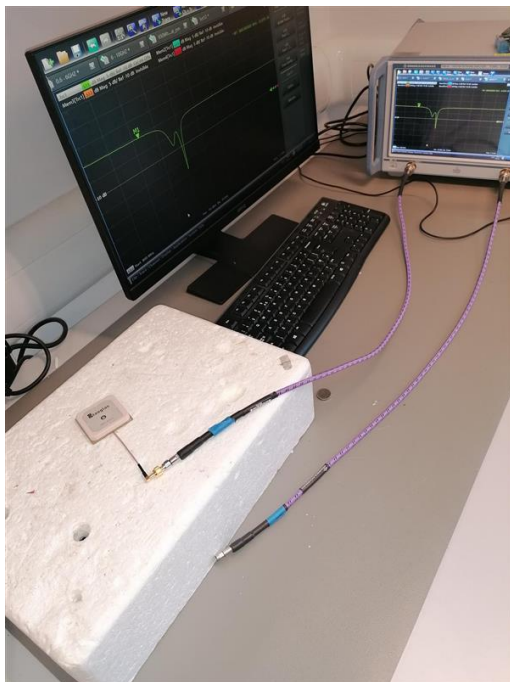
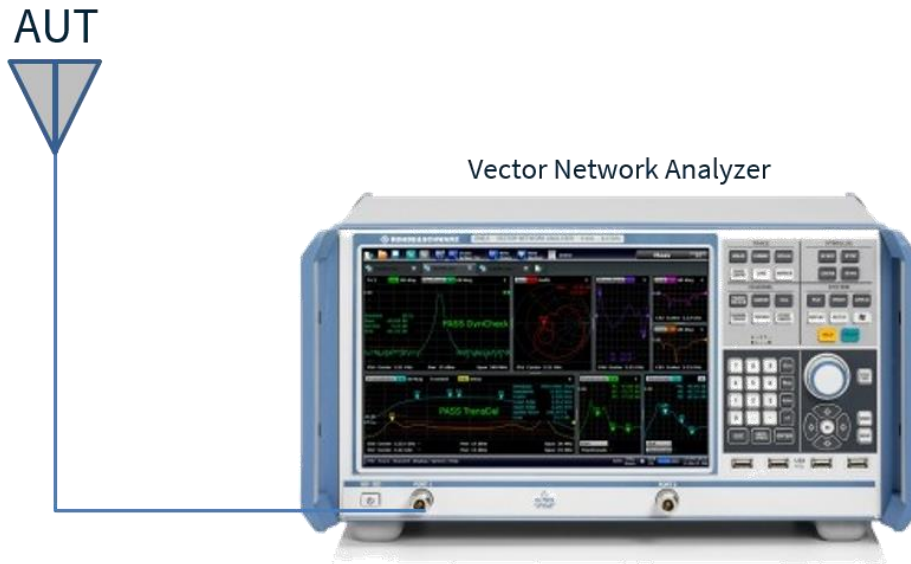

Free space

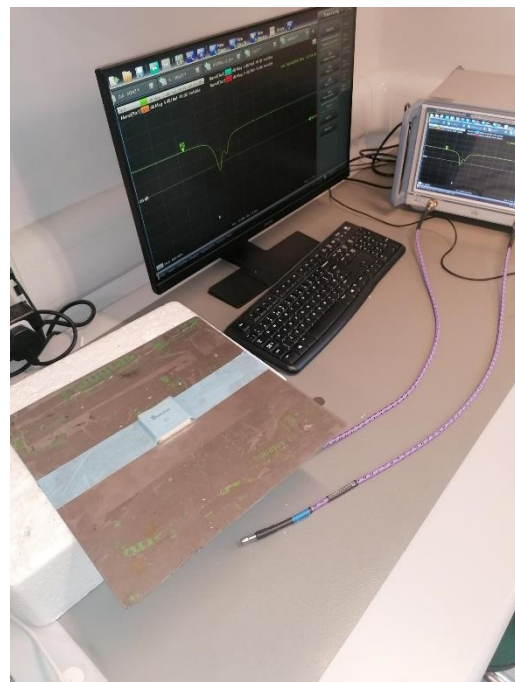

30x30cm Ground Plane

3.2 Return Loss

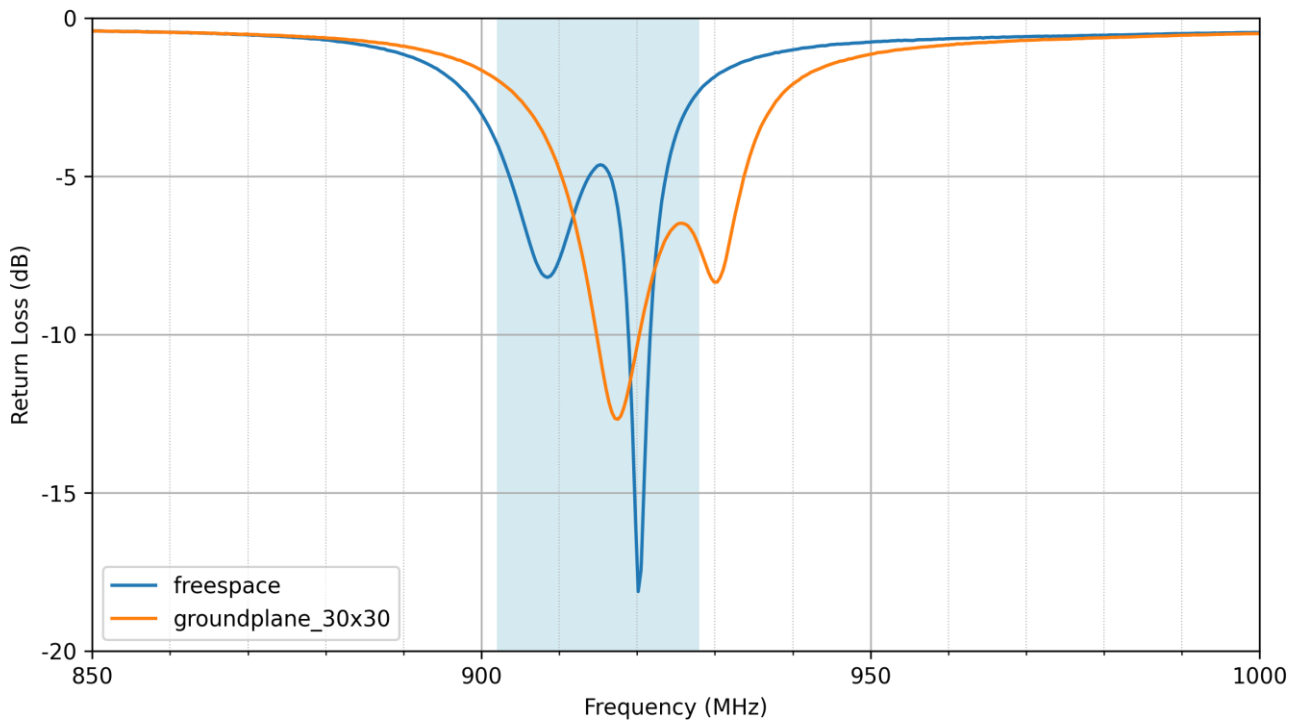

3.3 VSWR

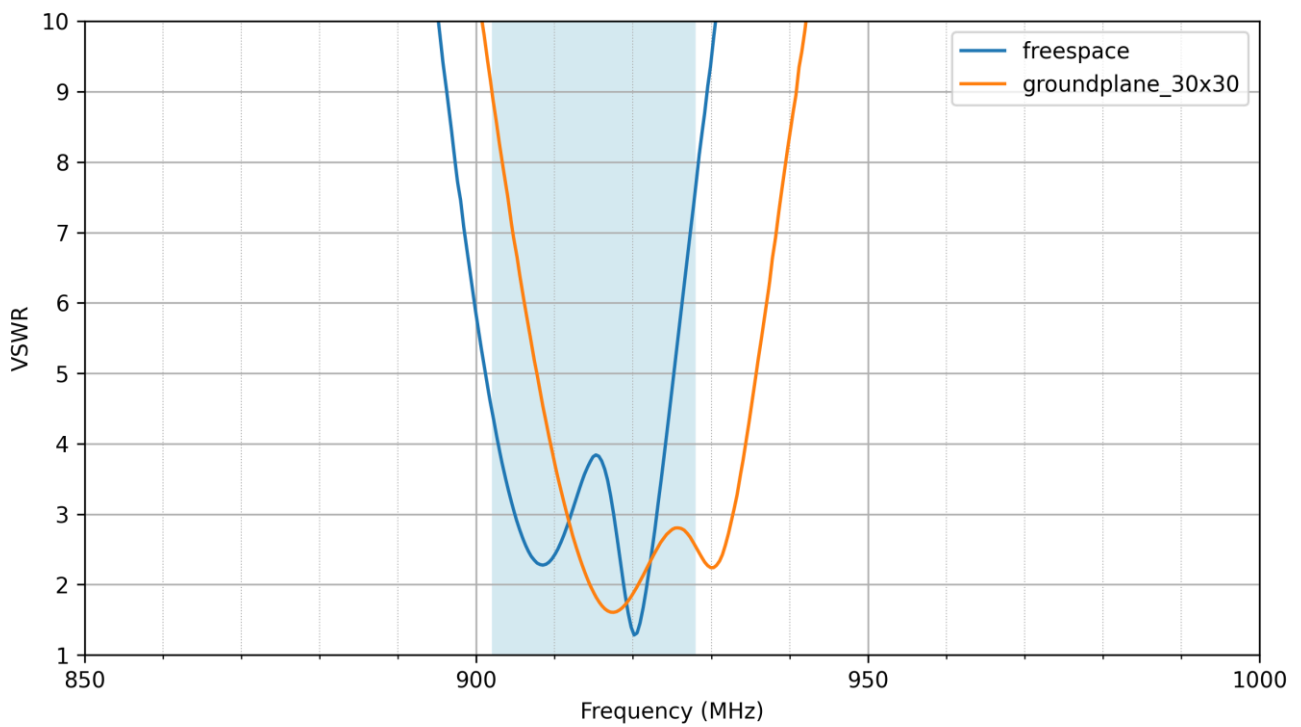

3.4 Efficiency

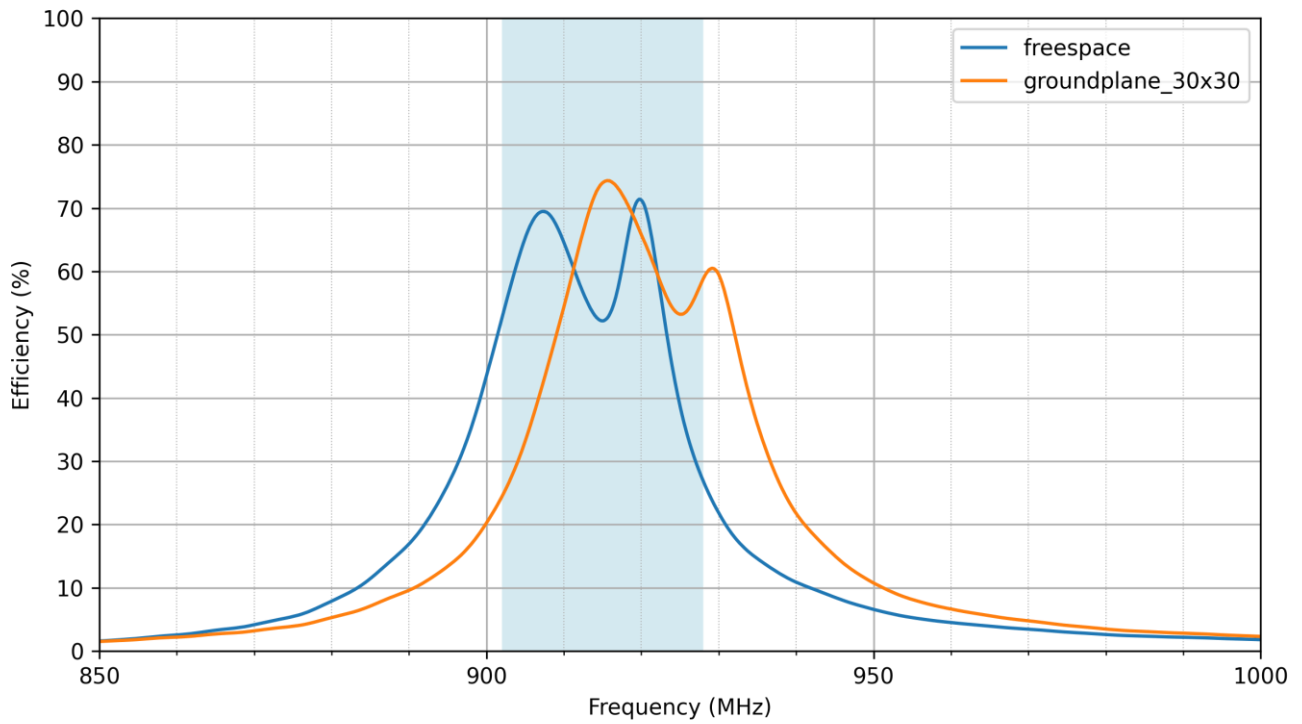

3.5 Average Gain

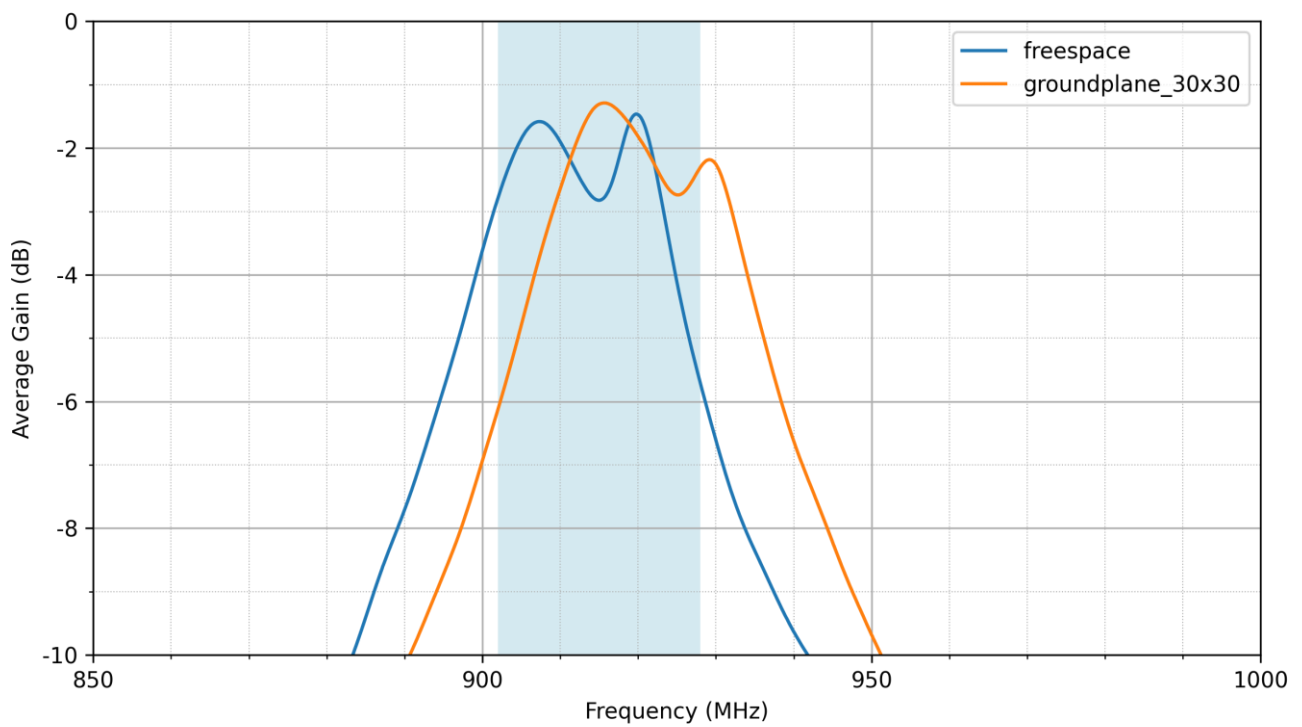

3.6 Peak Gain

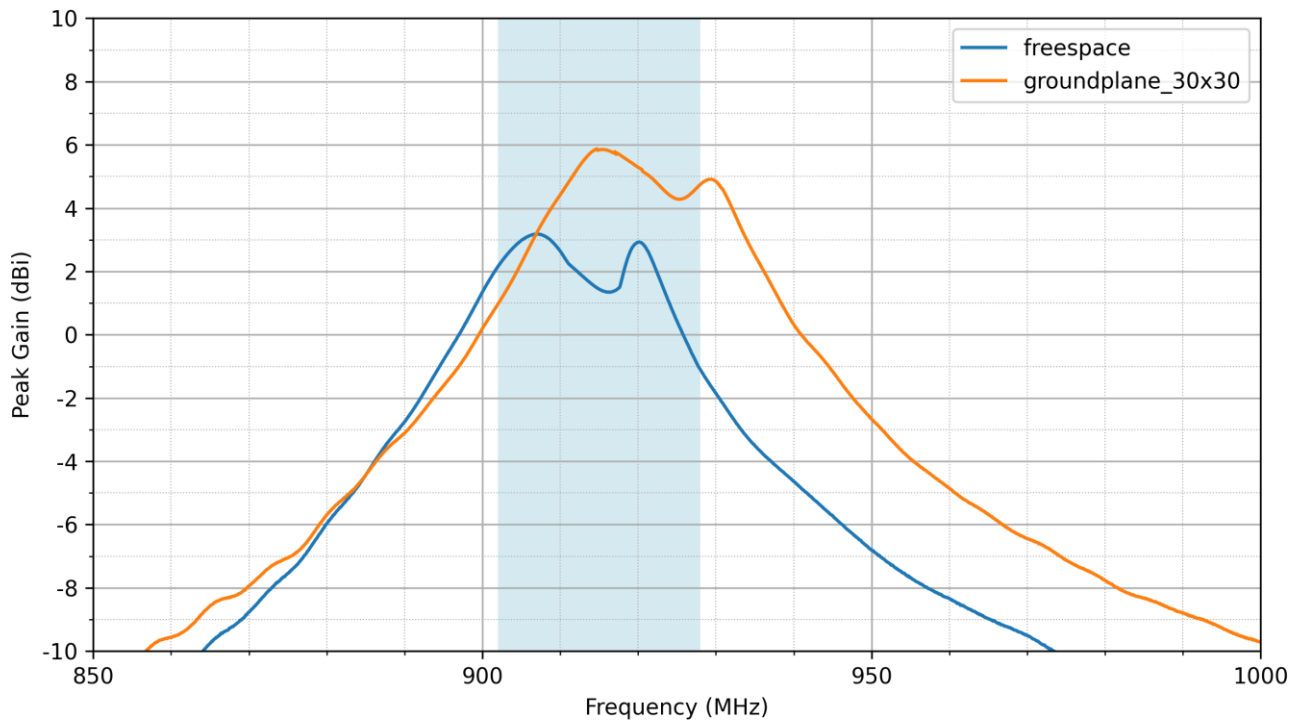

3.7 Axial Ratio

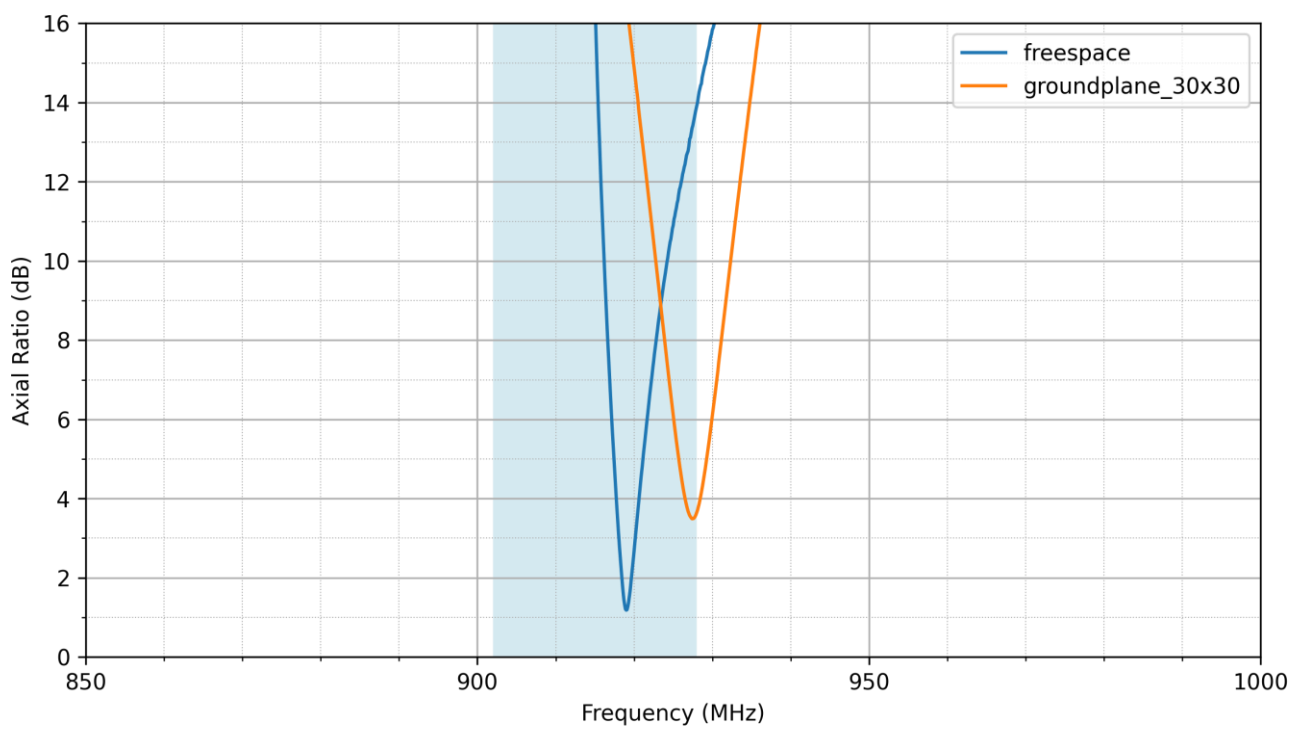

4. Radiation Patterns

4.1 Test Setup

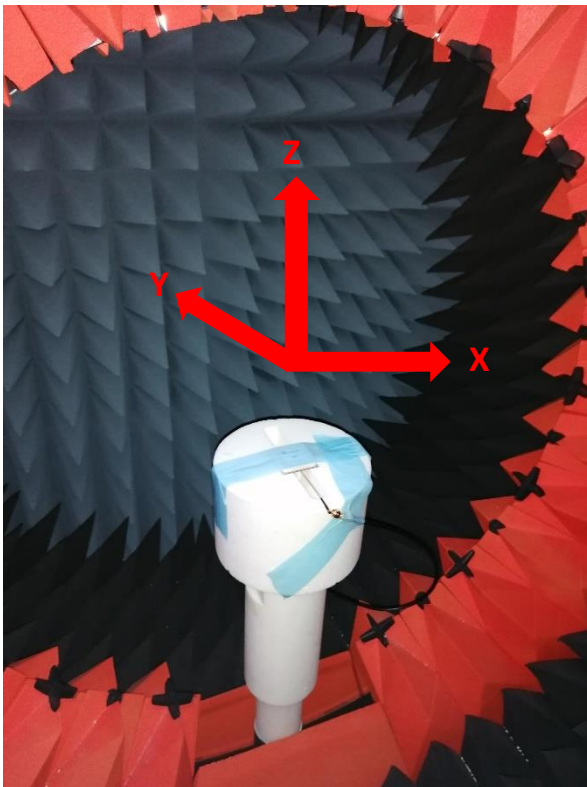
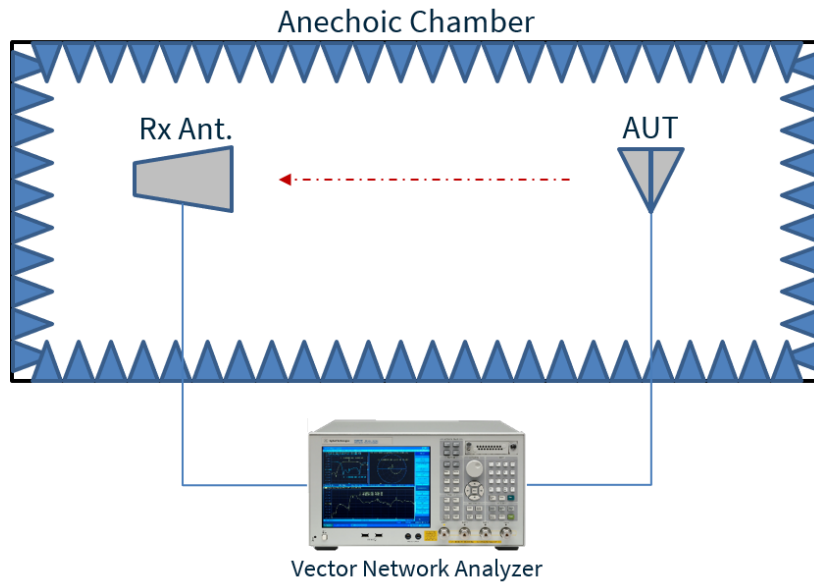

Free space



30x30cm Ground Plane

4.2 Free Space Patterns at 915 MHz

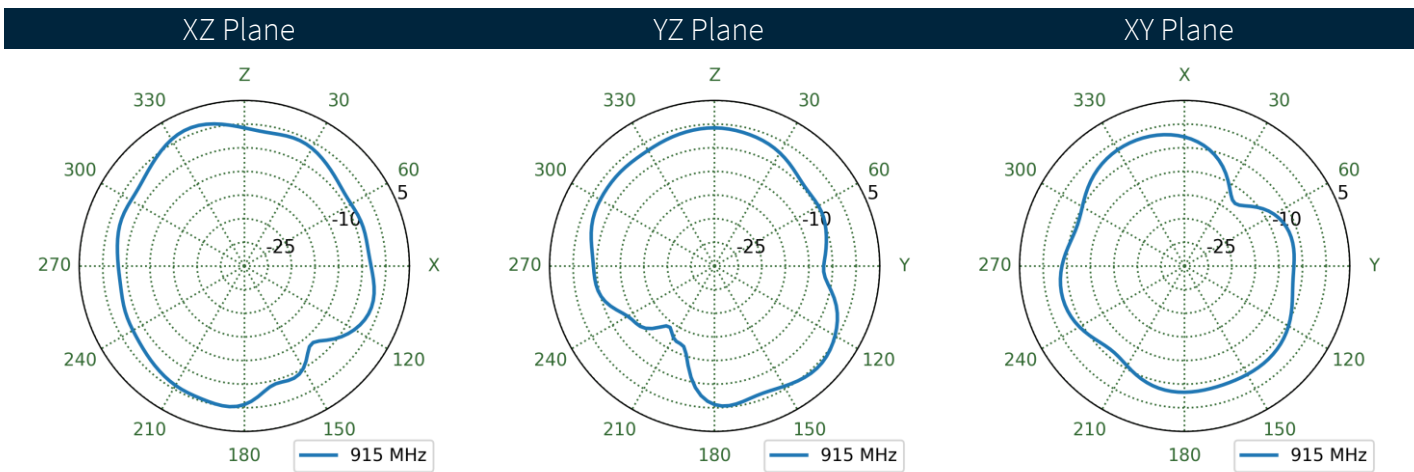
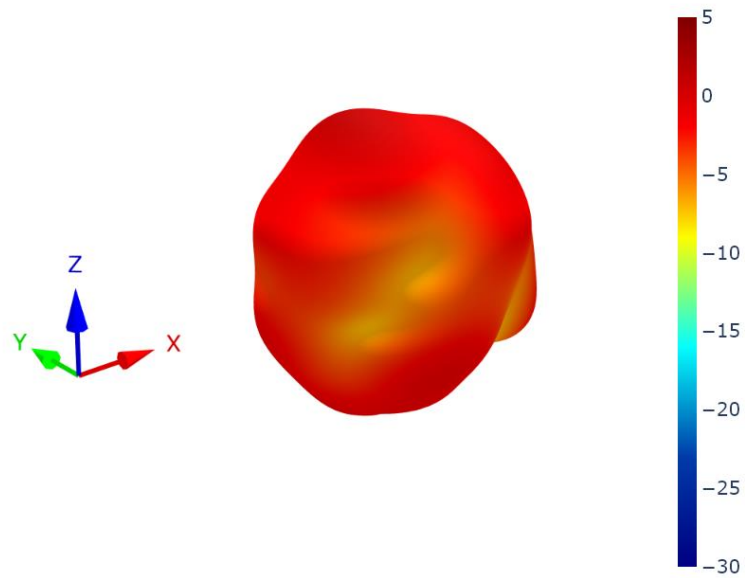

4.3 Ground Plane 30x30 Patterns at 915 MHz

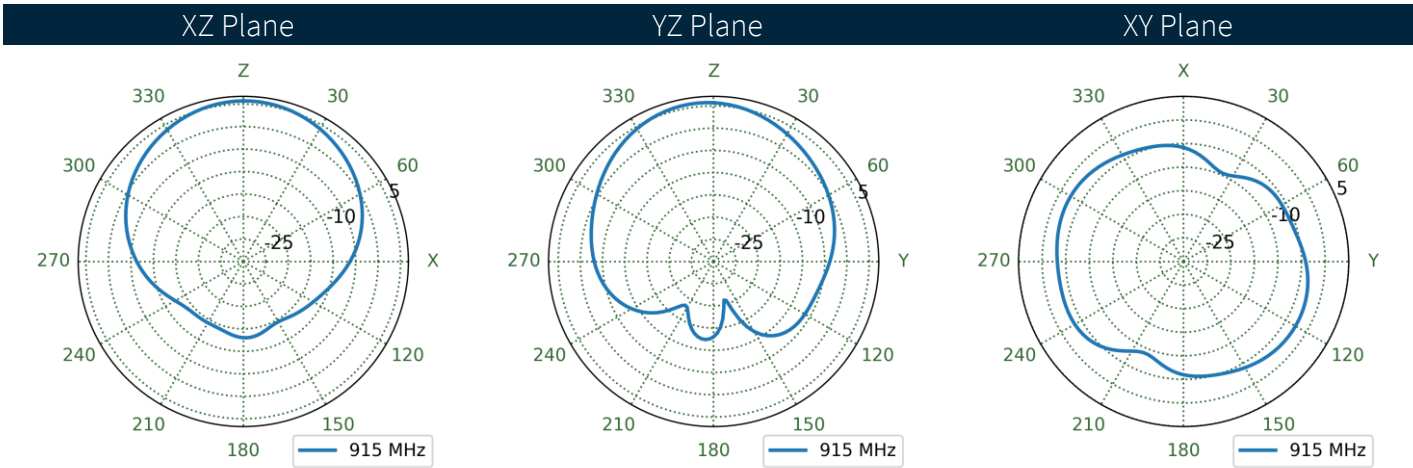
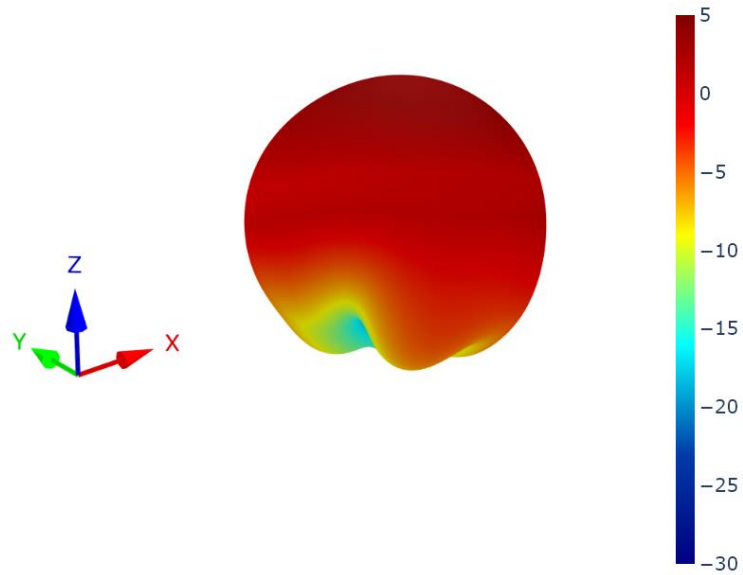

5. Mechanical Drawing

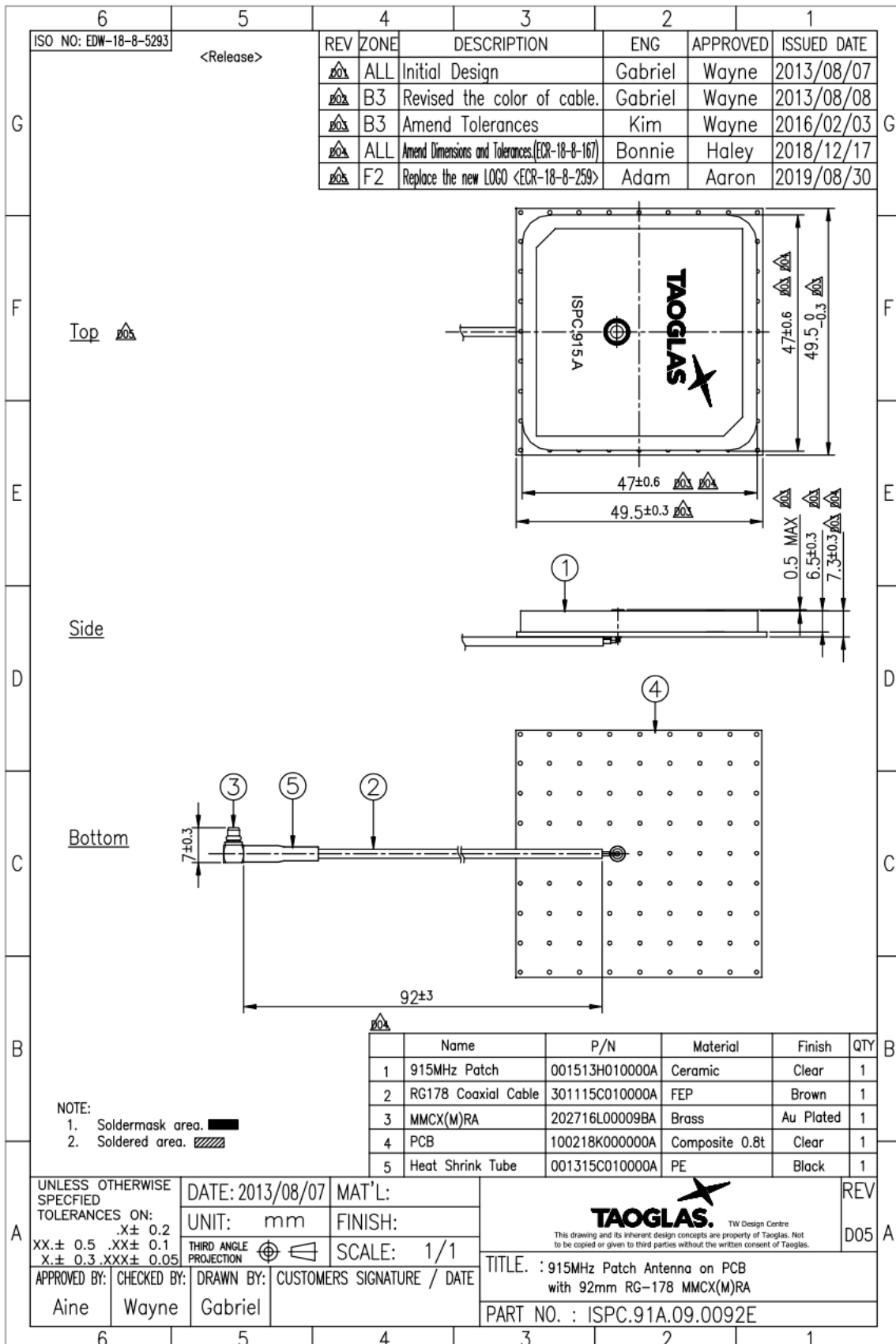

6. Packaging

8 pieces per Tray
 5 Trays per Small Box: 40 pieces
 4 Small Box's per Larger Box: 160 pieces

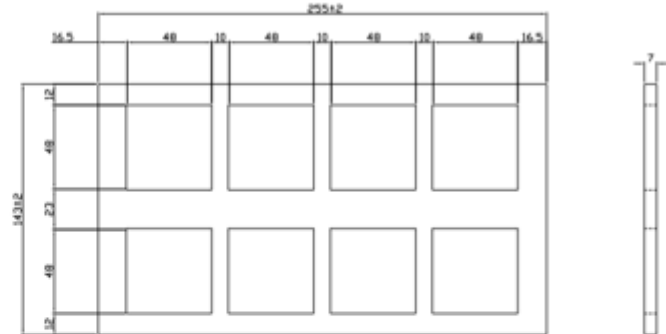

Inner Carton
 Dimensions - 263*154*96mm

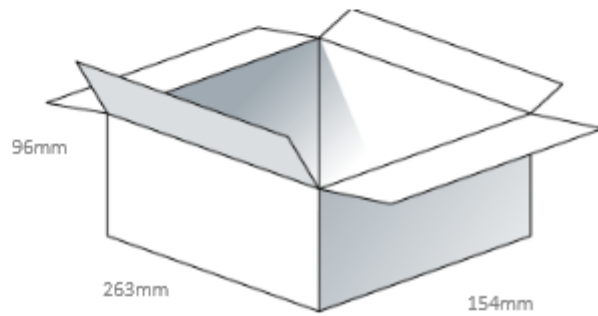

Exterior Carton
 Dimensions - 327*280*218mm

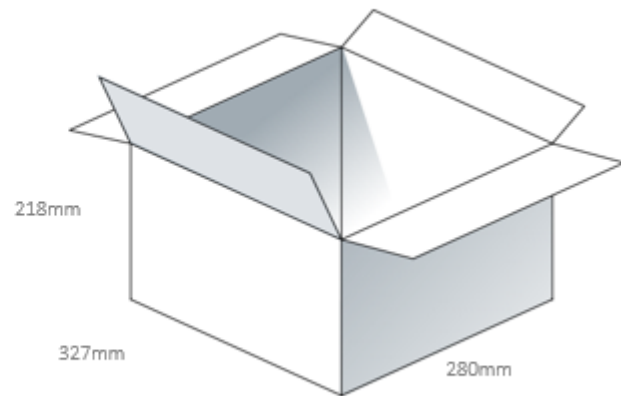

7. Application Note

Taoglas considers the application here of the ISPC.91A antenna in different typical environments. Some environments the antenna will be close to ground plane (or general metal objects) and at different orientations. The distance to ground-plane will also differ. Following this rationale, we compiled the antenna S11 variation charts as below to evaluate the typical effects on performance. A degraded return loss would generally decrease efficiency, peak gain, and deform radiation patterns. ****Note - while it may appear from the return loss on the ground above antenna that the antenna may work in this orientation, it is likely the gain and efficiency are very poor we would not recommend it under any circumstance****

There are three general situations of a ground plane orientation to antenna, the setup is as below.



Ground under antenna



Ground above antenna



Ground side of antenna

7.1 Ground Under Antenna

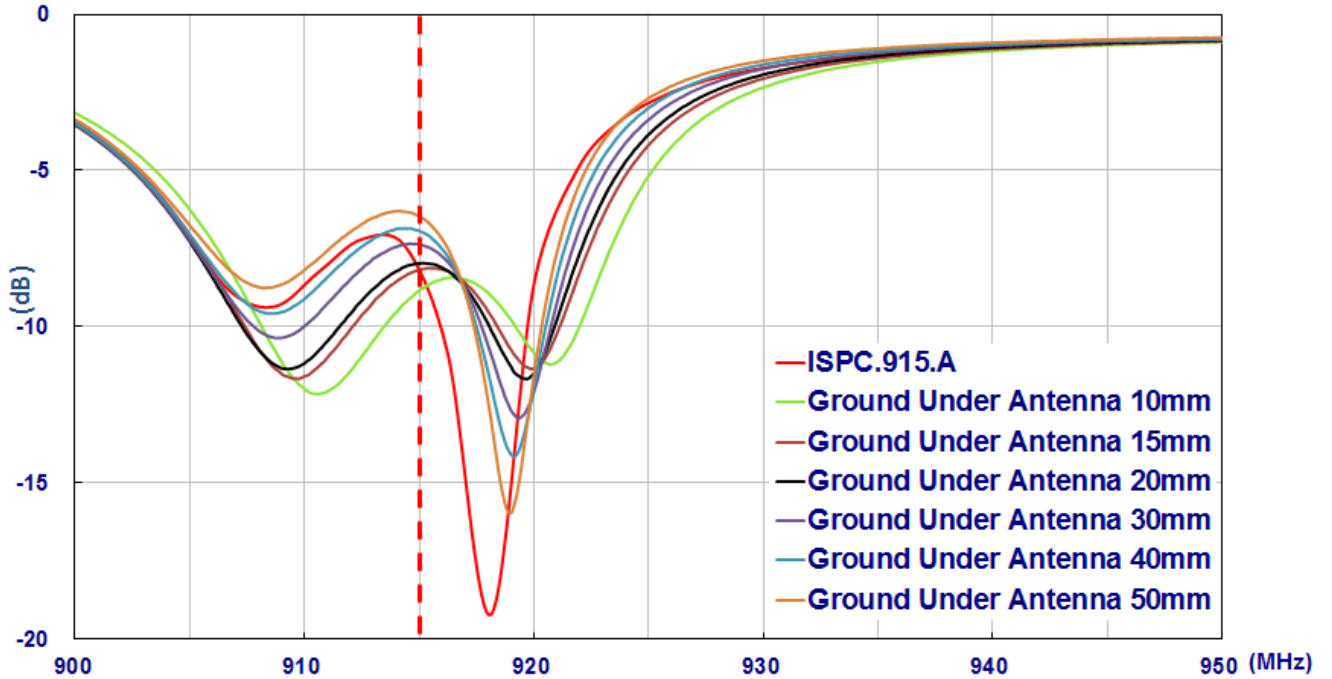
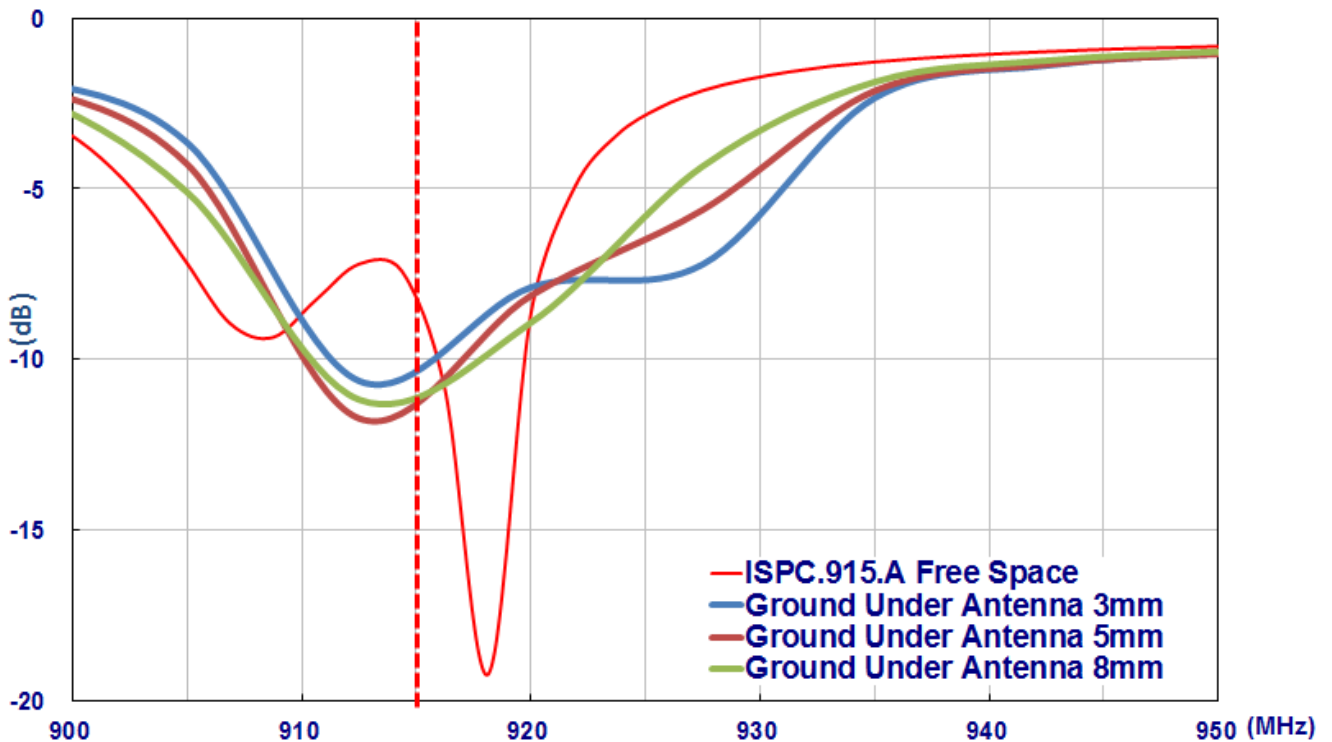

7.2 Ground Above Antenna

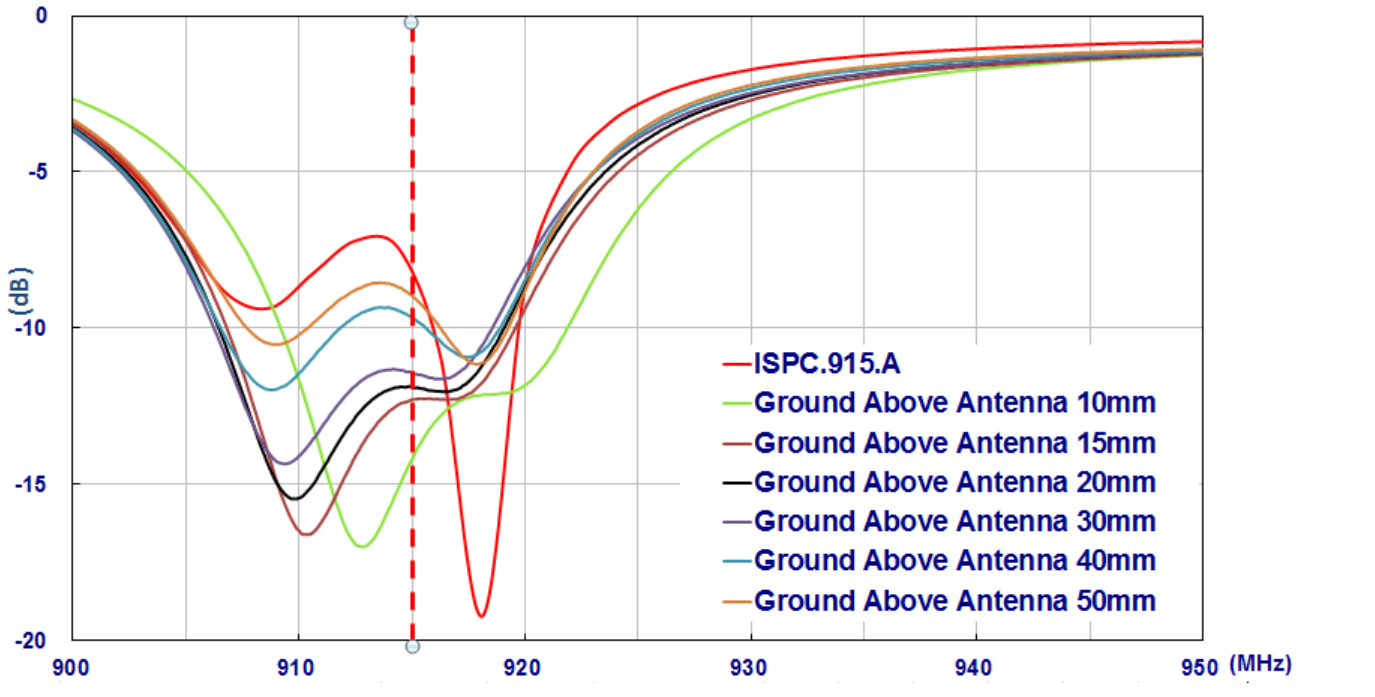
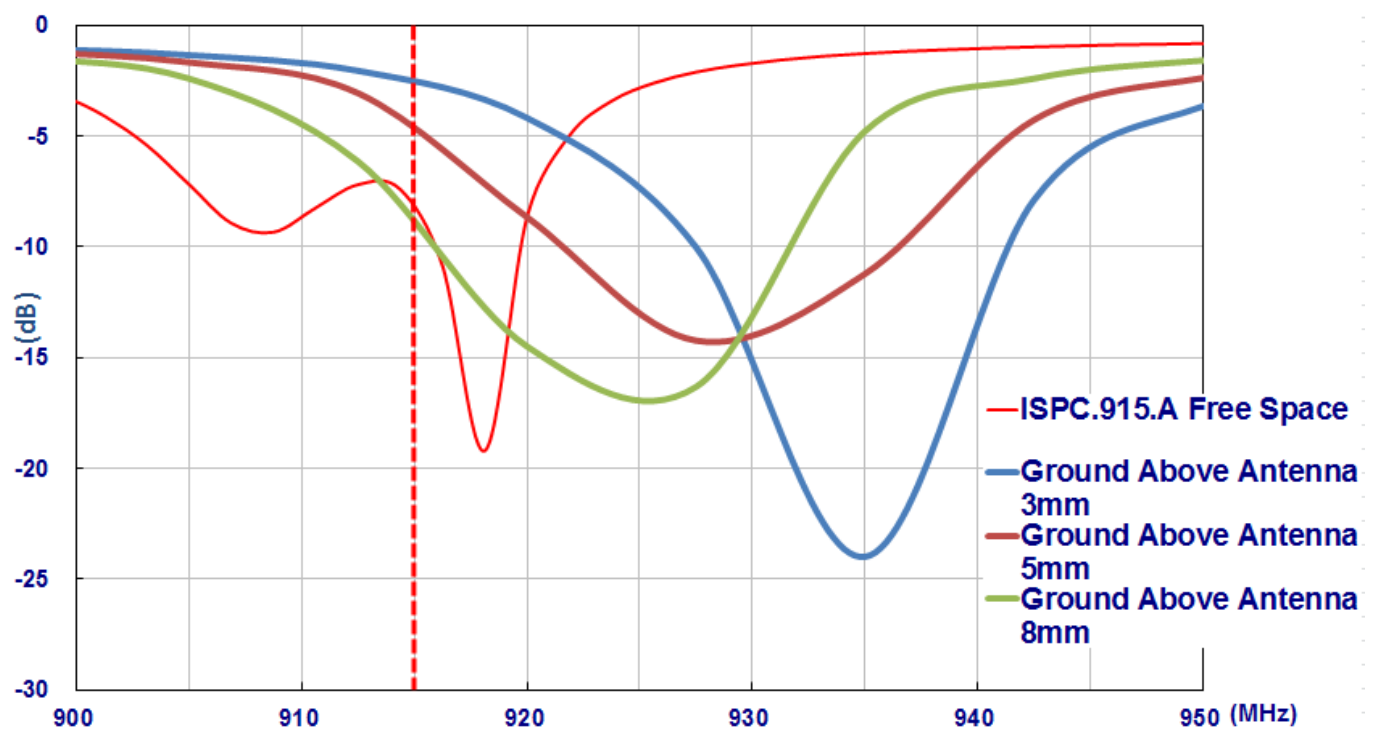

7.3 Ground Side of Antenna

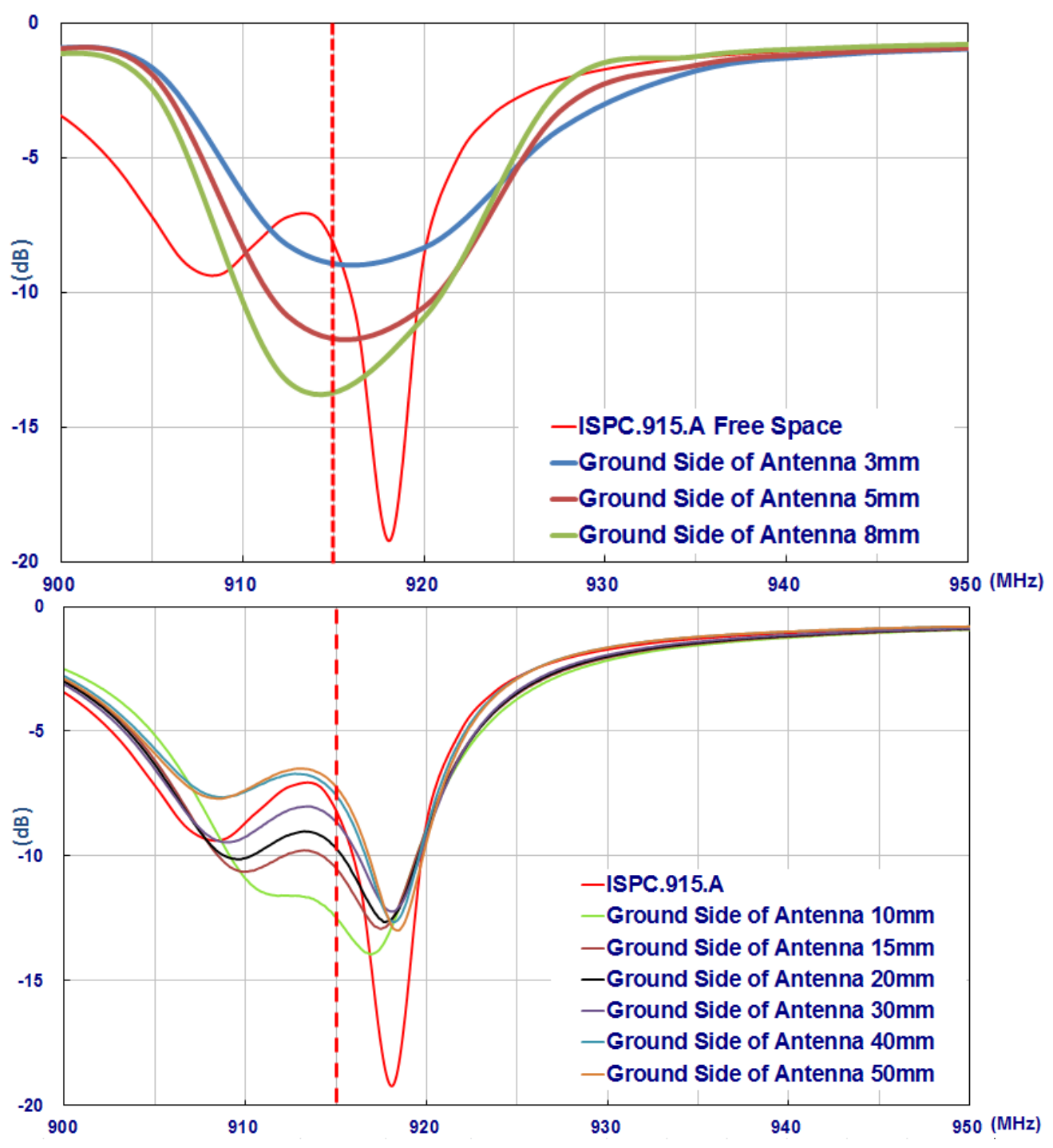

Changelog for the datasheet

SPE-14-8-058-F ISPC.91A.09.0092E

Revision: G (Current Version)

Date:	2023-03-14
Changes:	Full datasheet update
Changes Made by:	Gary West

Previous Revisions

Revision: F

Date:	2021-08-26
Changes:	Update Drawing Template Update
Changes Made by:	Erik Landi

Revision: A (Original First Release)

Date:	2014-05-29
Notes:	Initial Release
Author:	Staff

Revision: E

Date:	2019-04-01
Changes:	Patch now 47 not 47.5mm square Added Weight of 59g
Changes Made by:	David Connolly

Revision: D

Date:	2018-12-14
Changes:	
Changes Made by:	Andy Mahoney

Revision: C

Date:	2017-08-6
Changes:	Amended opart number, reformated and added disclaimer
Changes Made by:	Andy Mahoney

Revision: B

Date:	2014-06-11
Changes:	Packaging Details Updated
Changes Made by:	Andy Mahoney



www.taoglas.com

