

3 PIN

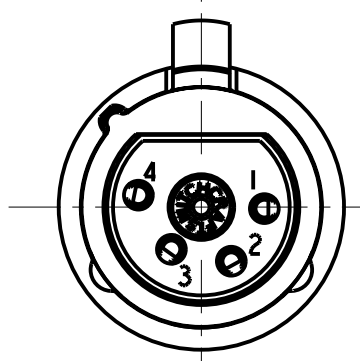

4 PIN

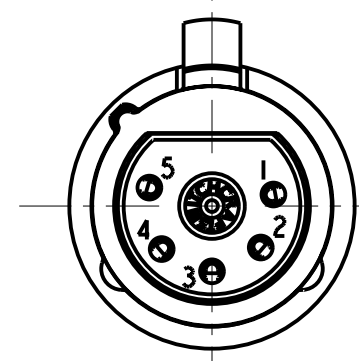

5 PIN

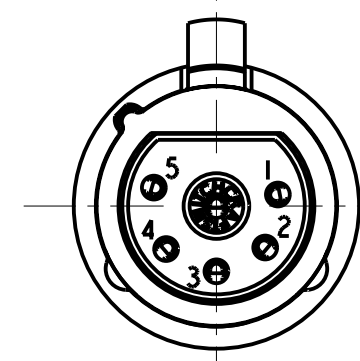

6 PIN

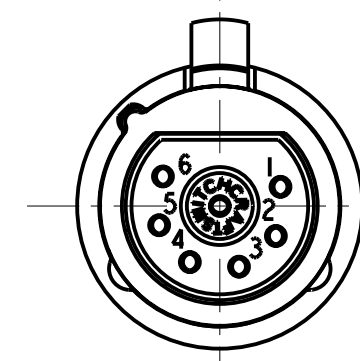

7 PIN

STANDARD SERIES

INSERT SCREW - STAINLESS STEEL  
 FLEX SCREW - STEEL, NICKEL PLATED  
 HOUSING - ZINC, NICKEL PLATED  
 SHELL - STAINLESS STEEL  
 LATCH BUTTON - ZINC, NICKEL PLATED  
 LATCH SPRING - STAINLESS STEEL  
 CONTACTOR - BERYLLIUM COPPER, NICKEL PLATE  
 TUBULAR INSULATOR - MYLAR  
 SOLDER TERMINAL - BRASS, ELECTRO TIN  
 FLEX RELIEF - HI-FAX, BLACK - STANDARD (X)  
 CLAMP PLATE - STAINLESS STEEL  
 INSULATORS - POLYESTER, GREEN  
 CONTACTS - BRASS, SILVER PLATED

- A F
- ↑ ↑ ↑ ↑ ↑
- COLOR OF FLEX RELIEF
  - 01 = BROWN
  - 02 = RED
  - 03 = ORANGE
  - 04 = YELLOW
  - 05 = GREEN
  - 06 = BLUE
  - 07 = VIOLET
  - 08 = GRAY
  - 09 = WHITE
  - 11 = TAN
  - 12 = PINK
  - 13 = DARK BLUE
- CONTACT PLATING
  - BLANK = SILVER (STANDARD)
  - AU = GOLD
- HOUSING FINISH (SEE NOTE 2)
  - BLANK = NICKEL PLATE (STANDARD)
  - BX = BLACK, RoHS
- LATCH TYPE
  - BLANK = STANDARD LATCHLOCK
  - D = FAS-DIS-CONNECT DETENT (SEE FIGURE 3)
- FLEX RELIEF SIZE
  - BLANK = STANDARD SIZE (0.210 TO 0.300)
  - L = LARGE CABLES (0.300 TO .0328)
  - S = SMALL CABLES (0.105 TO 0.205)
- NO. OF CONTACTS:
  - 3 = 3 CONTACTS
  - 4 = 4 CONTACTS
  - 5 = 5 CONTACTS
  - 6 = 6 CONTACTS
  - 7 = 7 CONTACTS

PROFESSIONAL SERIES

SAME AS ABOVE EXCEPT  
 CONTACT PIN - PHOSPHOR BRONZE, GOLD OVER NICKEL  
 HOUSING - NON REFLECTIVE VEL-TONE FINISH  
 FLEX RELIEF - GRAY  
 OGP .22  
 NO. OF CONTACTS:  
 3 = 3 CONTACTS

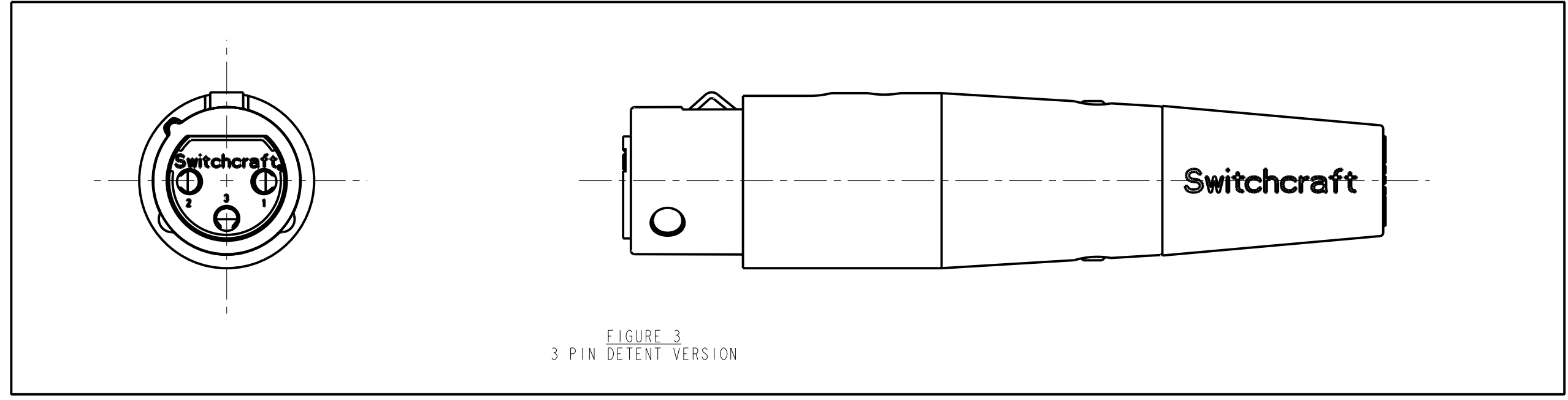
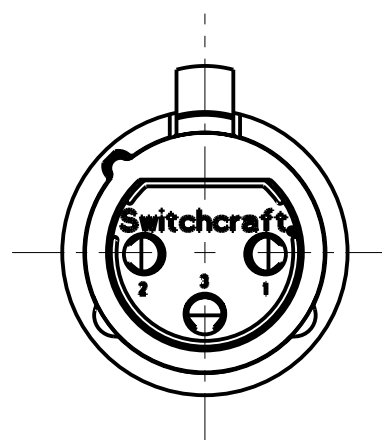
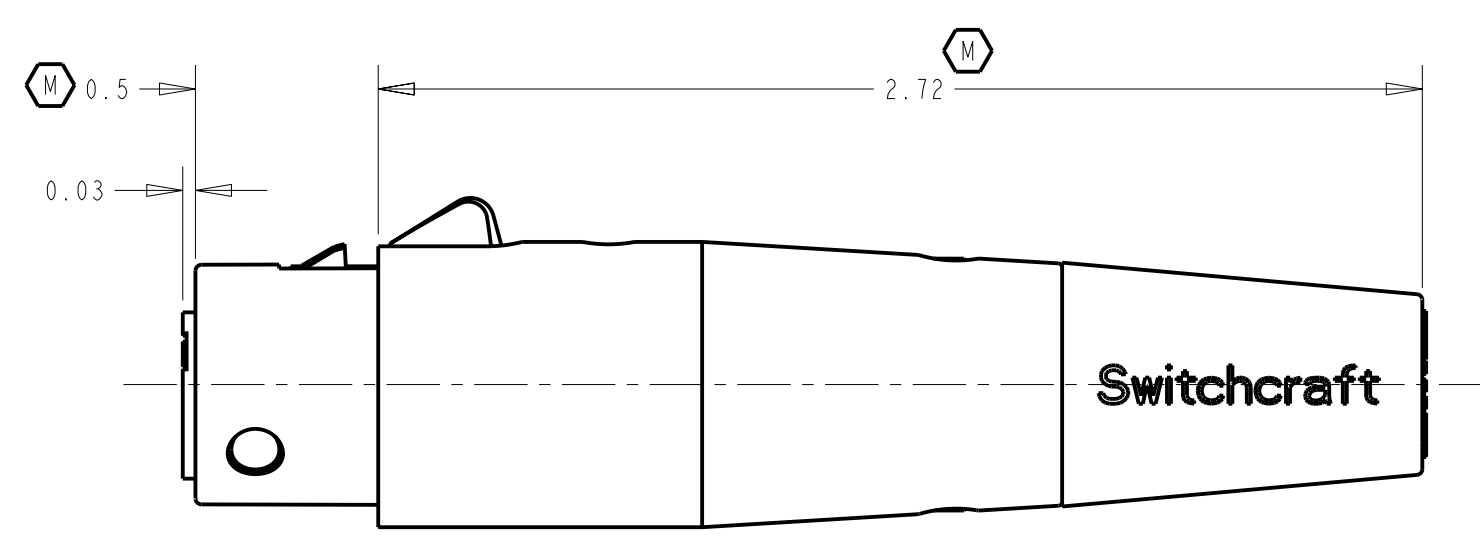
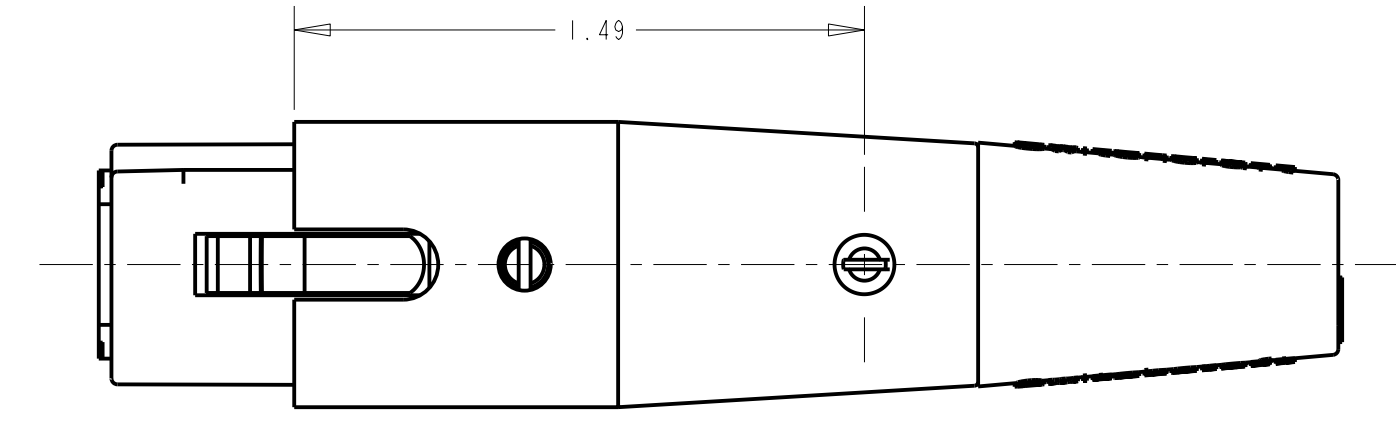

FIGURE 3  
3 PIN DETENT VERSION



- NOTE:
1. ALL DIMENSIONS REF. UNLESS OTHERWISE SPECIFIED.
  - (X) 2. BLACK HOUSING AND INSERT WITH SATIN NICKEL PLATED LATCH.
  - (X) 3. THIS PRODUCT IS RoHS COMPLIANT.

CUSTOMER DRAWING

☆ STAR SYMBOL DENOTES CRITICAL DIMENSION UNLESS OTHERWISE SPECIFIED 1. ALL DIMENSIONS IN INCHES - TWO PLACE DECIMALS ±0.01 - THREE PLACE DECIMALS ±0.005 - ANGLES ±1° - ALL DIA. CONCENTRIC WITHIN 0.005 T.I.R. 2. FEATURES ON THE SAME CENTERLINE MUST BE ALIGNED WITHIN ±0.002 3. REMOVE ALL BURRS DO NOT SCALE DRAWING				THIS DRAWING DESCRIBES A DESIGN CONSIDERED PROPRIETARY IN NATURE, DEVELOPED AND MANUFACTURED BY SWITCHCRAFT INC. AND IS RELEASED ON A CONFIDENTIAL BASIS FOR IDENTIFICATION PURPOSES ONLY.			
SIZE	WIDTH	MULT	LBS/M	TEMPER	MATERIAL SPEC No.		
FINISH SPEC No.				SCALE 2:1		<b>Switchcraft</b> SHEET   OF   PART No. A_F_SERIES REV X	
FIRST USED ON		DATE DRAWN		BY	CHKD		
10-26-93		10-26-93		SG	SG		
10-26-93		1-19-95		GHJ	GHJ		
NAME				"A" SERIES FEMALE OGP, RoHS			
REVISIONS				REV			
REV	ECO NUMBER	DATE	BY	APVD			
X	26158	10-17-07	TJK	TJK			
W	ECO #22530	12-21-98	MM	EB			
V	22353	6-12-98	DA	EB			

# Mouser Electronics

Authorized Distributor

Click to View Pricing, Inventory, Delivery & Lifecycle Information:

## Switchcraft:

[A5F](#) [A3F](#) [M3M](#) [A7F](#) [A4F](#) [A6F](#) [A3FL](#) [A3FPKG](#) [A3FS](#) [A4FL](#) [M5M](#) [A3FBXAU](#) [A4FBX](#) [A4FBXAU](#) [A5FBX](#)  
[A5FBXAU](#) [A6FBX](#) [A6FBXAU](#) [A7FBX](#) [A7FBXAU](#) [A3FBX](#) [A4FD](#)