



## Power Mini SMD LED



19226

### DESCRIPTION

The new MiniLED series has been designed in a small white SMT package. The feature of the device is the very small package 2.3 mm x 1.3 mm x 1.4 mm. The MiniLED is an obvious solution for small-scale, high-power products that are expected to work reliably in an arduous environment. This is often the case in automotive and industrial application.

### PRODUCT GROUP AND PACKAGE DATA

- Product group: LED
- Product series: power
- Package: SMD MiniLED
- Angle of half intensity:  $\pm 60^\circ$

### FEATURES

- Utilizing latest advanced AlInGaP technology
- Available in 8 mm tape
- Luminous intensity and color categorized per packing unit
- Luminous intensity ratio per packing unit  $I_{Vmax}/I_{Vmin.} \leq 1.6$
- ESD-withstand voltage: up to 2 kV according to JESD22-A114-B
- Preconditioning according to JEDEC® level 2a
- IR reflow soldering
- AEC-Q101 qualified
- Material categorization: for definitions of compliance please see [www.vishay.com/doc?99912](http://www.vishay.com/doc?99912)



### APPLICATIONS

- Traffic signals and signs
- Interior and exterior lighting
- Dashboard illumination
- Indicator and backlighting purposes for audio, video, LCDs switches, symbols, illuminated advertising etc.

PARTS TABLE														
PART	COLOR	LUMINOUS INTENSITY (mcd)			at I <sub>F</sub> (mA)	WAVELENGTH (nm)			at I <sub>F</sub> (mA)	FORWARD VOLTAGE (V)			at I <sub>F</sub> (mA)	TECHNOLOGY
		MIN.	TYP.	MAX.		MIN.	TYP.	MAX.		MIN.	TYP.	MAX.		
VLMS235S2U1-GS08	Super red	224	370	560	20	626	630	639	20	1.8	2.1	2.6	20	AllnGaP on Si
VLMR235T2V1-GS08	Red	355	520	900	20	619	625	631	20	1.8	2.1	2.6	20	AllnGaP on Si
VLMK235T2V1-GS08	Amber	355	550	900	20	611	616	622	20	1.8	2.0	2.6	20	AllnGaP on Si
VLMO235U1V2-GS08	Soft orange	450	650	1120	20	600	605	611	20	1.8	2.0	2.6	20	AllnGaP on Si
VLMO235U2V2-35-08	Soft orange	560	700	1120	20	602	605	609	20	1.8	2.0	2.6	20	AllnGaP on Si
VLMY235T2V1-GS08	Yellow	355	520	900	20	583	589	594	20	1.8	2.1	2.6	20	AllnGaP on Si

ABSOLUTE MAXIMUM RATINGS (T <sub>amb</sub> = 25 °C, unless otherwise specified) VLMS235.., VLMR235.., VLMK235.., VLMO235.., VLMY235..				
PARAMETER	TEST CONDITION	SYMBOL	VALUE	UNIT
Reverse voltage <sup>(1)</sup>	Not designed for reverse operation	V <sub>R</sub>	-	V
DC Forward current	T <sub>amb</sub> ≤ 60 °C (480 K/W)	I <sub>F</sub>	50	mA
Power dissipation		P <sub>V</sub>	130	mW
Junction temperature		T <sub>j</sub>	125	°C
Operating temperature range		T <sub>amb</sub>	-40 to +100	°C
Storage temperature range		T <sub>stg</sub>	-40 to +100	°C
Thermal resistance junction-to-ambient	Mounted on PC board (pad size > 16 mm <sup>2</sup> )	R <sub>thJA</sub>	480	K/W

### Note

<sup>(1)</sup> Driving the LED in reverse direction is suitable for a short term application only



<b>OPTICAL AND ELECTRICAL CHARACTERISTICS</b> ( $T_{amb} = 25\text{ }^{\circ}\text{C}$ , unless otherwise specified)							
<b>VLMS235.., SUPER RED</b>							
PARAMETER	TEST CONDITION	PART	SYMBOL	MIN.	TYP.	MAX.	UNIT
Luminous intensity	$I_F = 20\text{ mA}$	VLMS235S2U1	$I_V$	224	370	560	mcd
Luminous flux/luminous intensity			$\phi_V/I_V$	-	3	-	mlm/mcd
Dominant wavelength	$I_F = 20\text{ mA}$		$\lambda_d$	626	630	639	nm
Peak wavelength	$I_F = 20\text{ mA}$		$\lambda_p$	-	639	-	nm
Spectral bandwidth at 50 % $I_{rel\ max.}$	$I_F = 20\text{ mA}$		$\Delta\lambda$	-	18	-	nm
Angle of half intensity	$I_F = 20\text{ mA}$		$\phi$	-	$\pm 60$	-	deg
Forward voltage	$I_F = 20\text{ mA}$		$V_F$	1.8	2.1	2.6	V
Reverse current	$V_R = 5\text{ V}$		$I_R$	-	0.01	10	$\mu\text{A}$

<b>OPTICAL AND ELECTRICAL CHARACTERISTICS</b> ( $T_{amb} = 25\text{ }^{\circ}\text{C}$ , unless otherwise specified)							
<b>VLMR235.., RED</b>							
PARAMETER	TEST CONDITION	PART	SYMBOL	MIN.	TYP.	MAX.	UNIT
Luminous intensity	$I_F = 20\text{ mA}$	VLMR235T2V1	$I_V$	355	520	900	mcd
Luminous flux/luminous intensity			$\phi_V/I_V$	-	3	-	mlm/mcd
Dominant wavelength	$I_F = 20\text{ mA}$		$\lambda_d$	619	625	631	nm
Peak wavelength	$I_F = 20\text{ mA}$		$\lambda_p$	-	632	-	nm
Spectral bandwidth at 50 % $I_{rel\ max.}$	$I_F = 20\text{ mA}$		$\Delta\lambda$	-	18	-	nm
Angle of half intensity	$I_F = 20\text{ mA}$		$\phi$	-	$\pm 60$	-	deg
Forward voltage	$I_F = 20\text{ mA}$		$V_F$	1.8	2.1	2.6	V
Reverse current	$V_R = 5\text{ V}$		$I_R$	-	0.01	10	$\mu\text{A}$

<b>OPTICAL AND ELECTRICAL CHARACTERISTICS</b> ( $T_{amb} = 25\text{ }^{\circ}\text{C}$ , unless otherwise specified)							
<b>VLMK235.., AMBER</b>							
PARAMETER	TEST CONDITION	PART	SYMBOL	MIN.	TYP.	MAX.	UNIT
Luminous intensity	$I_F = 20\text{ mA}$	VLMK235T2V1	$I_V$	355	550	900	mcd
Luminous flux/luminous intensity			$\phi_V/I_V$	-	3	-	mlm/mcd
Dominant wavelength	$I_F = 20\text{ mA}$		$\lambda_d$	611	616	622	nm
Peak wavelength	$I_F = 20\text{ mA}$		$\lambda_p$	-	622	-	nm
Spectral bandwidth at 50 % $I_{rel\ max.}$	$I_F = 20\text{ mA}$		$\Delta\lambda$	-	18	-	nm
Angle of half intensity	$I_F = 20\text{ mA}$		$\phi$	-	$\pm 60$	-	deg
Forward voltage	$I_F = 20\text{ mA}$		$V_F$	1.8	2.0	2.6	V
Reverse current	$V_R = 5\text{ V}$		$I_R$	-	0.01	10	$\mu\text{A}$

<b>OPTICAL AND ELECTRICAL CHARACTERISTICS</b> ( $T_{amb} = 25\text{ }^{\circ}\text{C}$ , unless otherwise specified)							
<b>VLMO235.., SOFT ORANGE</b>							
PARAMETER	TEST CONDITION	PART	SYMBOL	MIN.	TYP.	MAX.	UNIT
Luminous intensity	$I_F = 20\text{ mA}$	VLMO235U1V2	$I_V$	450	650	1120	mcd
		VLMO235U2V2-35		560	700	1120	
Luminous flux/luminous intensity			$\phi_V/I_V$	-	3	-	mlm/mcd
Dominant wavelength	$I_F = 20\text{ mA}$	VLMO235U1V2	$\lambda_d$	600	605	611	nm
		VLMO235U2V2-35		602	605	609	nm
Peak wavelength	$I_F = 20\text{ mA}$		$\lambda_p$	-	611	-	nm
Spectral bandwidth at 50 % $I_{rel\ max.}$	$I_F = 20\text{ mA}$		$\Delta\lambda$	-	17	-	nm
Angle of half intensity	$I_F = 20\text{ mA}$		$\phi$	-	$\pm 60$	-	deg
Forward voltage	$I_F = 20\text{ mA}$		$V_F$	1.8	2.0	2.6	V
Reverse current	$V_R = 5\text{ V}$		$I_R$	-	0.01	10	$\mu\text{A}$



<b>OPTICAL AND ELECTRICAL CHARACTERISTICS</b> ( $T_{amb} = 25\text{ }^{\circ}\text{C}$ , unless otherwise specified)							
<b>VLMY235.., YELLOW</b>							
PARAMETER	TEST CONDITION	PART	SYMBOL	MIN.	TYP.	MAX.	UNIT
Luminous intensity	$I_F = 20\text{ mA}$	VLMY235T2V1	$I_V$	355	520	900	mcd
Luminous flux/luminous intensity			$\phi_V/I_V$	-	3	-	mlm/mcd
Dominant wavelength	$I_F = 20\text{ mA}$		$\lambda_d$	583	589	594	nm
Peak wavelength	$I_F = 20\text{ mA}$		$\lambda_p$	-	591	-	nm
Spectral bandwidth at 50 % $I_{rel\ max.}$	$I_F = 20\text{ mA}$		$\Delta\lambda$	-	17	-	nm
Angle of half intensity	$I_F = 20\text{ mA}$		$\phi$	-	$\pm 60$	-	deg
Forward voltage	$I_F = 20\text{ mA}$		$V_F$	1.8	2.1	2.6	V
Reverse current	$V_R = 5\text{ V}$		$I_R$	-	0.01	10	$\mu\text{A}$

<b>COLOR CLASSIFICATION</b>						
GROUP	DOMINANT WAVELENGTH (nm)					
	AMBER		SOFT ORANGE		YELLOW	
	MIN.	MAX.	MIN.	MAX.	MIN.	MAX.
1	611	618				
2	614	622	600	603	583	586
3			602	605	585	588
4			604	607	587	590
5			606	609	589	592
6			608	611	591	594

**Note**

- Wavelengths are tested at a current pulse duration of 25 ms

<b>LUMINOUS INTENSITY CLASSIFICATION</b>			
GROUP	LUMINOUS INTENSITY (mcd)		
STANDARD	OPTIONAL	MIN.	MAX.
S	2	224	280
T	1	280	355
	2	355	450
U	1	450	560
	2	560	710
V	1	710	900
	2	900	1120

**Note**

- Luminous intensity is tested at a current pulse duration of 25 ms and an accuracy of  $\pm 11\%$ .  
The above type numbers represent the order groups which include only a few brightness groups. Only one group will be shipped on each reel (there will be no mixing of two groups on each reel).  
In order to ensure availability, single brightness groups will not be orderable.  
In a similar manner for colors where wavelength groups are measured and binned, single wavelength groups will be shipped on any one reel.  
In order to ensure availability, single wavelength groups will not be orderable

<b>CROSSING TABLE</b>	
VISHAY	OSRAM
VLMS235S2U1	LAM67B-T2V1-1
VLMO235U2V2-35	LS M67F-S2U2-1
VLMY235T2V1	LO M67F-U2AB-24
	LY M67F-T2V2-36



TYPICAL CHARACTERISTICS (T<sub>amb</sub> = 25 °C, unless otherwise specified)

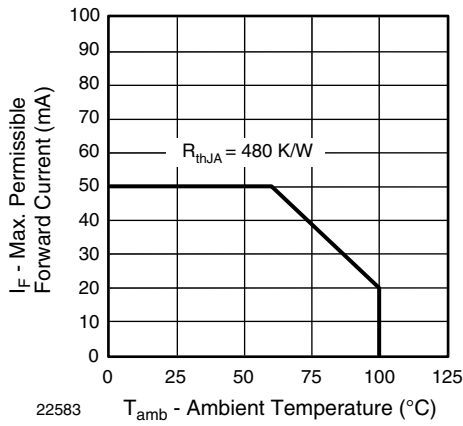

Fig. 1 - Maximum Permissible Forward Current vs. Ambient Temperature

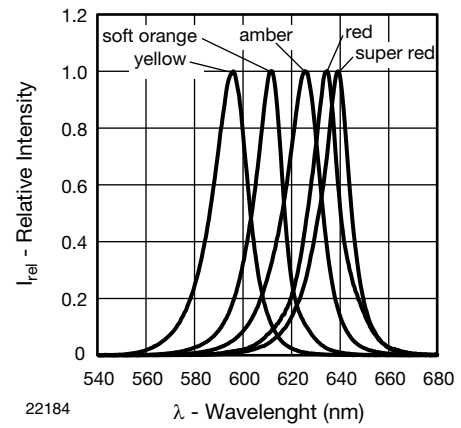

Fig. 4 - Relative Intensity vs. Wavelength

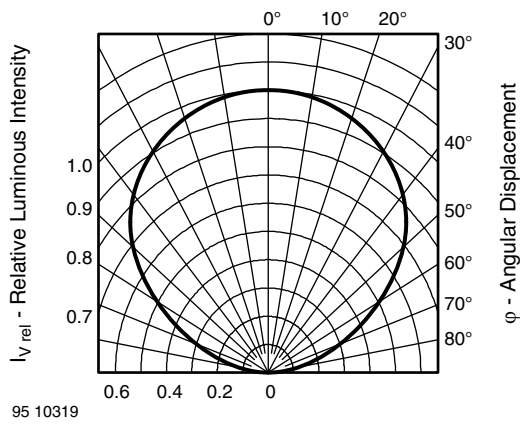

Fig. 2 - Relative Luminous Intensity vs. Angular Displacement

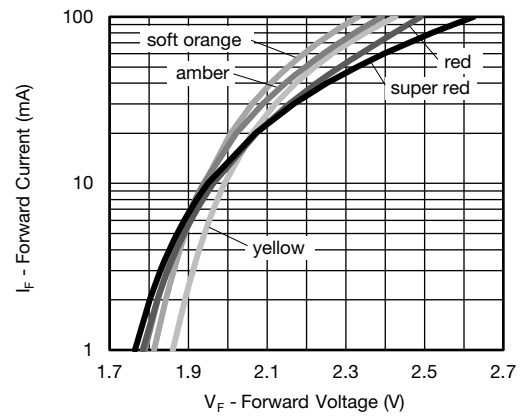

Fig. 5 - Forward Current vs. Forward Voltage

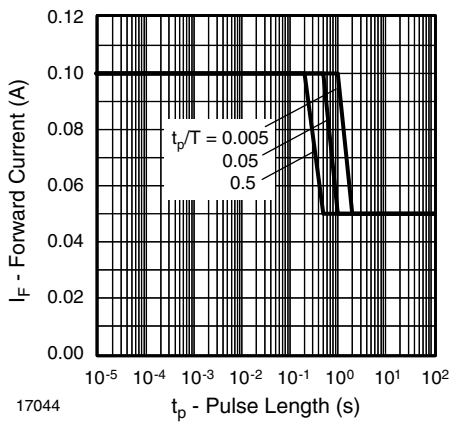

Fig. 3 - Forward Current vs. Pulse Length

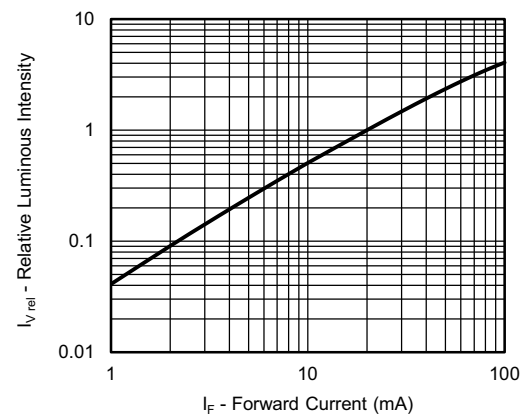

Fig. 6 - Relative Luminous Intensity vs. Forward Current

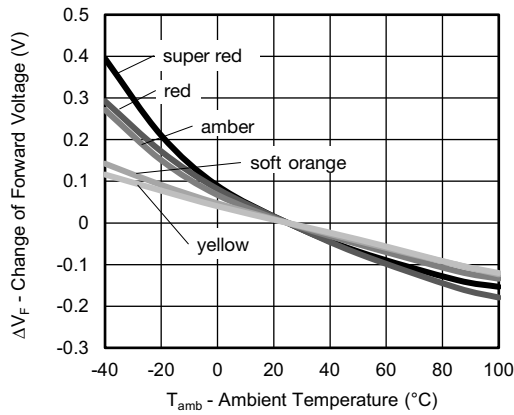

Fig. 7 - Change of Forward Voltage vs. Ambient Temperature

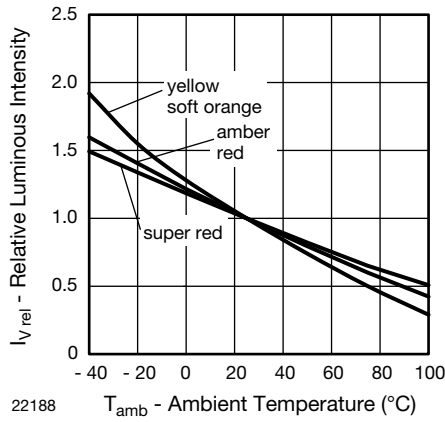

Fig. 8 - Relative Luminous Intensity vs. Ambient Temperature

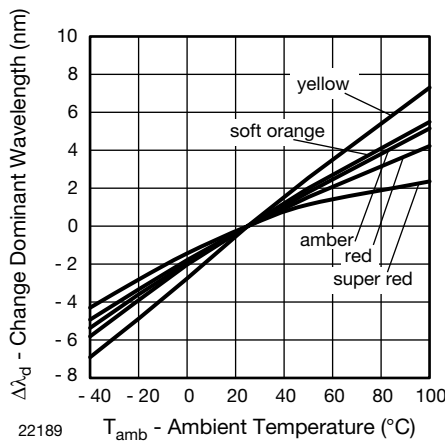
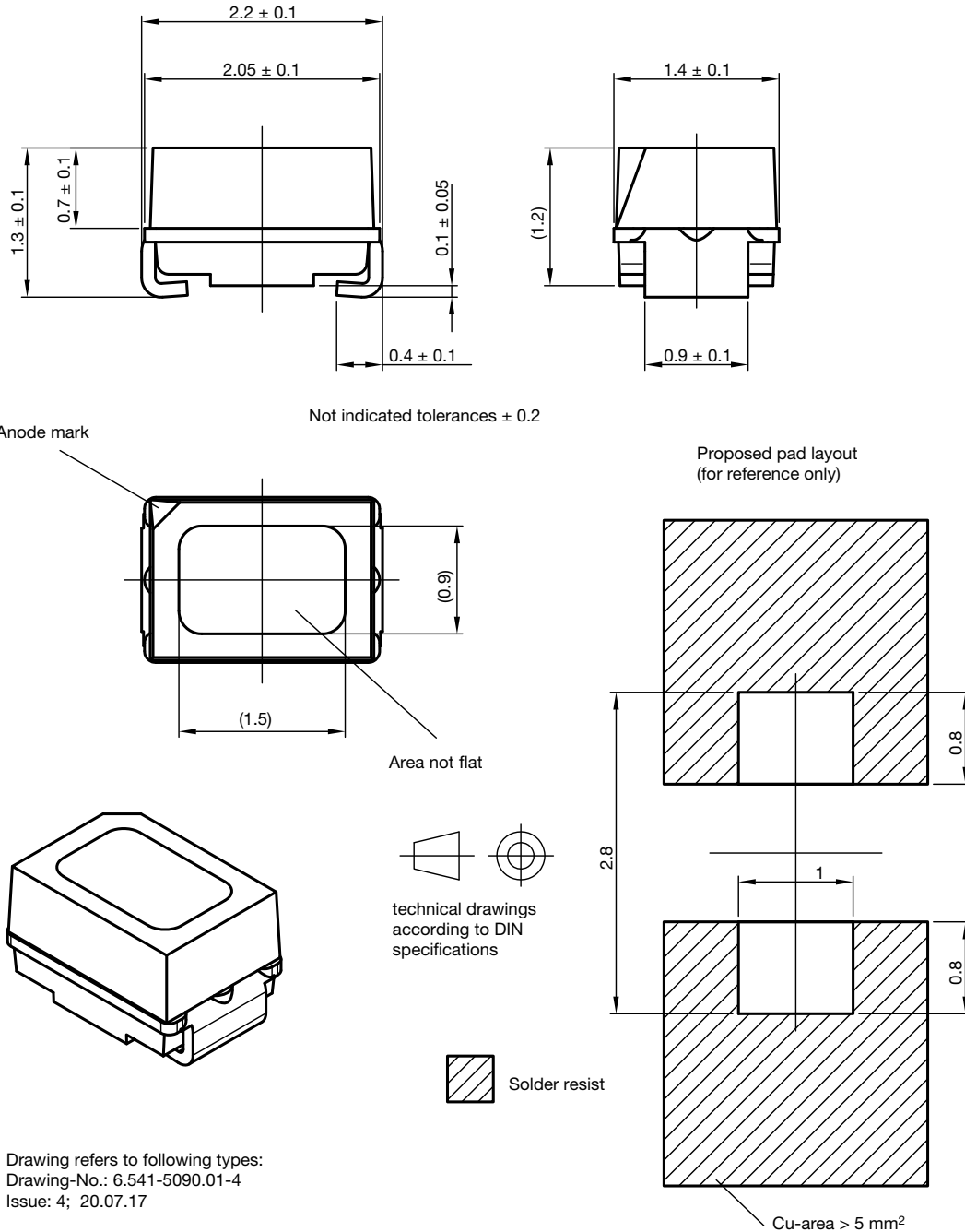

Fig. 9 - Change of Dominant Wavelength vs. Ambient Temperature



PACKAGE DIMENSIONS in millimeters



Drawing refers to following types:  
Drawing-No.: 6.541-5090.01-4  
Issue: 4; 20.07.17



**TAPE DIMENSIONS** in millimeters

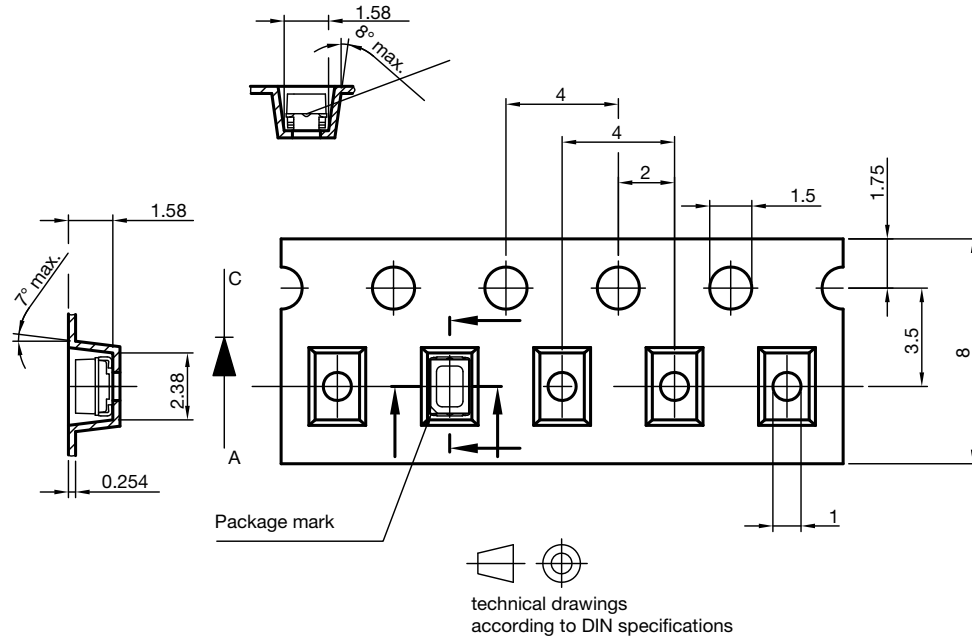

Drawing refers to following types: Mini - SMD - LED with reverse polarity: VLM. 233..., VLM. 235...  
 Drawing-No.: 9.700-5381.01-4  
 Issue: 2; 20.07.17

**LEADER AND TRAILER DIMENSIONS** in millimeters

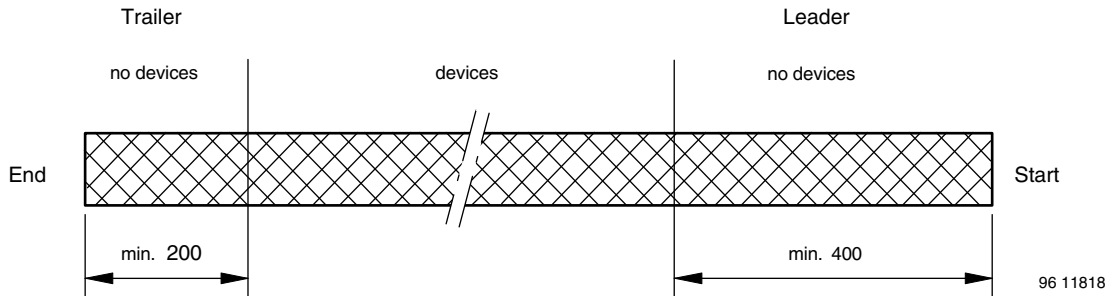

GS08 = 3000 pcs

**COVER TAPE PEEL STRENGTH**

According to DIN EN 60286-3  
 0.1 N to 1.3 N  
 300 mm/min ± 10 mm/min  
 165° to 180° peel angle

**LABEL**

**Standard bar code labels for finished goods**

The standard bar code labels are product labels and used for identification of goods. The finished goods are packed in final packing area. The standard packing units are labeled with standard bar code labels before transported as finished goods to warehouses. The labels are on each packing unit and contain Vishay Semiconductor GmbH specific data.



SOLDERING PROFILE

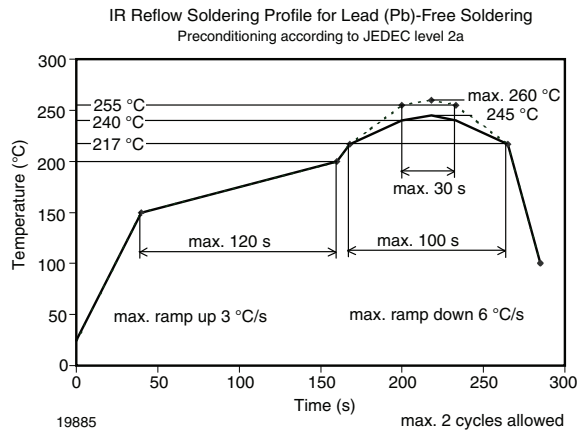
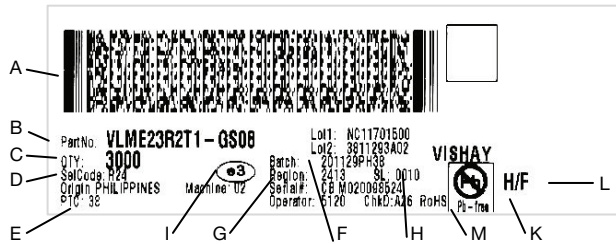

Fig. 10 - Vishay Lead (Pb)-free Reflow Soldering Profile (according to J-STD-020)

BAR CODE PRODUCT LABEL (example)



- A. 2D bar code
B. Part number = Vishay part number
C. QTY = Quantity
D. Sel. code = selection code (binning)
E. PTC = Code of manufacturing plant
F. Batch = date code: year / week / plant code
G. Region code
H. SL = sales location
I. Terminations finishing
J. Lead (Pb)-free symbol
K. Halogen-free symbol
L. RoHS symbol

DRY PACKING

The reel is packed in an anti-humidity bag to protect the devices from absorbing moisture during transportation and storage.

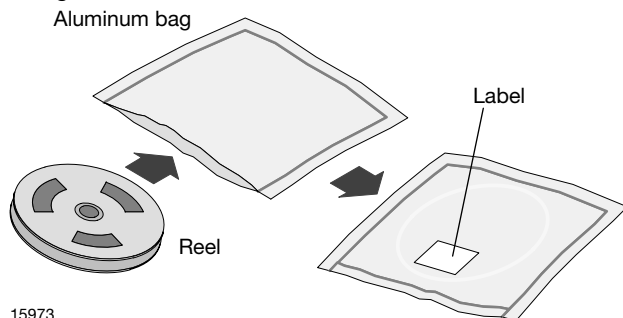

FINAL PACKING

The sealed reel is packed into a cardboard box. A secondary cardboard box is used for shipping purposes.

RECOMMENDED METHOD OF STORAGE

Dry box storage is recommended as soon as the aluminum bag has been opened to prevent moisture absorption. The following conditions should be observed, if dry boxes are not available:

- Storage temperature 10 °C to 30 °C
Storage humidity ≤ 60 % RH max.

After more than 672 h under these conditions moisture content will be too high for reflow soldering.

In case of moisture absorption, the devices will recover to the former condition by drying under the following condition:

- 192 h at 40 °C + 5 °C / - 0 °C and < 5 % RH (dry air / nitrogen) or
96 h at 60 °C + 5 °C and < 5 % RH for all device containers or
24 h at 100 °C + 5 °C not suitable for reel or tubes.

An EIA JEDEC standard JESD22-A112 level 2a label is included on all dry bags.

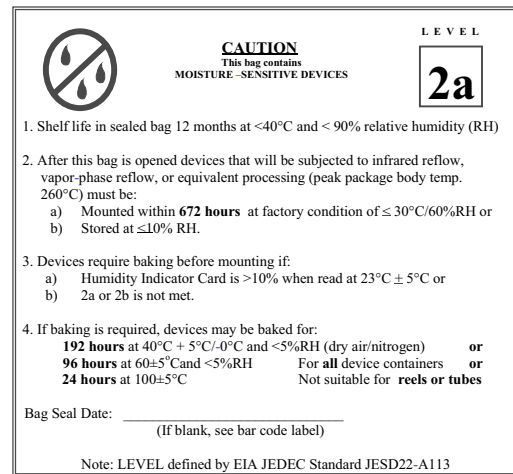

Example of JESD22-A112 level 2a label

ESD PRECAUTION

Proper storage and handling procedures should be followed to prevent ESD damage to the devices especially when they are removed from the antistatic shielding bag. Electrostatic sensitive devices warning labels are on the packaging.

VISHAY SEMICONDUCTORS STANDARD BAR CODE LABEL

The Vishay Semiconductors standard bar code labels are printed at final packing areas. The labels are on each packing unit and contain Vishay Semiconductors specific data.





## Disclaimer

ALL PRODUCT, PRODUCT SPECIFICATIONS AND DATA ARE SUBJECT TO CHANGE WITHOUT NOTICE TO IMPROVE RELIABILITY, FUNCTION OR DESIGN OR OTHERWISE.

Vishay Intertechnology, Inc., its affiliates, agents, and employees, and all persons acting on its or their behalf (collectively, "Vishay"), disclaim any and all liability for any errors, inaccuracies or incompleteness contained in any datasheet or in any other disclosure relating to any product.

Vishay makes no warranty, representation or guarantee regarding the suitability of the products for any particular purpose or the continuing production of any product. To the maximum extent permitted by applicable law, Vishay disclaims (i) any and all liability arising out of the application or use of any product, (ii) any and all liability, including without limitation special, consequential or incidental damages, and (iii) any and all implied warranties, including warranties of fitness for particular purpose, non-infringement and merchantability.

Statements regarding the suitability of products for certain types of applications are based on Vishay's knowledge of typical requirements that are often placed on Vishay products in generic applications. Such statements are not binding statements about the suitability of products for a particular application. It is the customer's responsibility to validate that a particular product with the properties described in the product specification is suitable for use in a particular application. Parameters provided in datasheets and / or specifications may vary in different applications and performance may vary over time. All operating parameters, including typical parameters, must be validated for each customer application by the customer's technical experts. Product specifications do not expand or otherwise modify Vishay's terms and conditions of purchase, including but not limited to the warranty expressed therein.

Except as expressly indicated in writing, Vishay products are not designed for use in medical, life-saving, or life-sustaining applications or for any other application in which the failure of the Vishay product could result in personal injury or death. Customers using or selling Vishay products not expressly indicated for use in such applications do so at their own risk. Please contact authorized Vishay personnel to obtain written terms and conditions regarding products designed for such applications.

No license, express or implied, by estoppel or otherwise, to any intellectual property rights is granted by this document or by any conduct of Vishay. Product names and markings noted herein may be trademarks of their respective owners.

# Mouser Electronics

Authorized Distributor

Click to View Pricing, Inventory, Delivery & Lifecycle Information:

[Vishay:](#)

[VLMR235T2V1-GS08](#) [VLMO235U1V2-GS08](#) [VLMO235U2V2-35-08](#) [VLMK235T2V1-GS08](#) [VLMS235S2U1-GS08](#)  
[VLMY235T2V1-GS08](#)