

KEMET Part Number: SC-15-05J
(UALSC1505J0000)

KEMET, SC-J, AC Line Filters, Common Mode, 500 uH

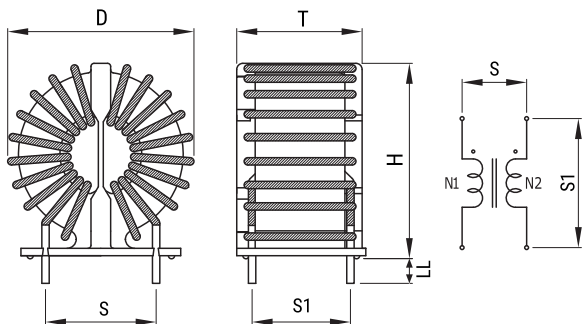

Dimensions

D	34mm MAX
T	23mm MAX
H	33mm MAX
LL	5mm +/-2mm
S	18mm NOM

Packaging Specifications

Packaging:	Tray
Packaging Quantity:	200
Weight:	40 g

General Information

Series:	SC-J
Style:	Through-Hole
RoHS:	Yes
Notes:	Lead Spacing (S/S1) Are For Reference Only.
Miscellaneous:	Temperature Rise Maximum: 60 K

Specifications

Voltage AC:	250 VAC
Inductance:	0.5 mH (100 kHz)
Current:	15 A
Temperature Range:	-25/+120°C
DC Resistance:	8 mOhms