

ULTRAFAST SOFT RECOVERY RECTIFIER DIODE

PRODUCT APPLICATIONS

- Anti-Parallel Diode
 - Switchmode Power Supply
 - Inverters
- Free Wheeling Diode
 - Motor Controllers
 - Converters
 - Inverters
- Snubber Diode
- PFC

PRODUCT FEATURES

- Ultrafast Recovery Times
- Soft Recovery Characteristics
- Popular TO-220 Package or Surface Mount D² PAK Package
- Low Forward Voltage
- Low Leakage Current

PRODUCT BENEFITS

- Low Losses
- Low Noise Switching
- Cooler Operation
- Higher Reliability Systems
- Increased System Power Density

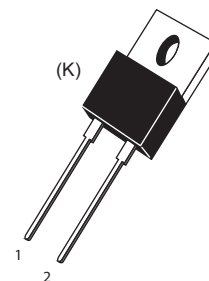

1 - Cathode
 2 - Anode
 Back of Case - Cathode

MAXIMUM RATINGS

All Ratings: $T_C = 25^\circ\text{C}$ unless otherwise specified.

Symbol	Characteristic / Test Conditions	APT15D60K(G)	UNIT
V_R	Maximum D.C. Reverse Voltage	600	Volts
V_{RRM}	Maximum Peak Repetitive Reverse Voltage		
V_{RWM}	Maximum Working Peak Reverse Voltage		
$I_{F(AV)}$	Maximum Average Forward Current ($T_C = 133^\circ\text{C}$, Duty Cycle = 0.5)	15	Amps
$I_{F(RMS)}$	RMS Forward Current (Square wave, 50% duty)	32	
I_{FSM}	Non-Repetitive Forward Surge Current ($T_J = 45^\circ\text{C}$, 8.3ms)	110	
T_J, T_{STG}	Operating and Storage Temperature Range	-55 to 175	$^\circ\text{C}$
T_L	Lead Temperature for 10 Sec.	300	

STATIC ELECTRICAL CHARACTERISTICS

Symbol	Characteristic / Test Conditions	MIN	TYP	MAX	UNIT
V_F	Forward Voltage	$I_F = 15\text{A}$	1.6	1.8	Volts
		$I_F = 30\text{A}$	1.9		
		$I_F = 15\text{A}, T_J = 125^\circ\text{C}$	1.4		
I_{RM}	Maximum Reverse Leakage Current	$V_R = V_R$ Rated		250	μA
		$V_R = V_R$ Rated, $T_J = 125^\circ\text{C}$		500	
C_T	Junction Capacitance, $V_R = 200\text{V}$		23		pF

DYNAMIC CHARACTERISTICS

APT15D60K(G)

Symbol	Characteristic	Test Conditions	MIN	TYP	MAX	UNIT
t_{rr}	Reverse Recovery Time	$I_F = 1A, di_F/dt = -100A/\mu s, V_R = 30V, T_J = 25^\circ C$	-	21		ns
t_{rr}	Reverse Recovery Time		-	80		
Q_{rr}	Reverse Recovery Charge	$I_F = 15A, di_F/dt = -200A/\mu s, V_R = 400V, T_C = 25^\circ C$	-	95		nC
I_{RRM}	Maximum Reverse Recovery Current		-	3	-	Amps
t_{rr}	Reverse Recovery Time	$I_F = 15A, di_F/dt = -200A/\mu s, V_R = 400V, T_C = 125^\circ C$	-	150		ns
Q_{rr}	Reverse Recovery Charge		-	520		nC
I_{RRM}	Maximum Reverse Recovery Current	-	7	-	Amps	
t_{rr}	Reverse Recovery Time	$I_F = 15A, di_F/dt = -1000A/\mu s, V_R = 400V, T_C = 125^\circ C$	-	60		ns
Q_{rr}	Reverse Recovery Charge		-	810		nC
I_{RRM}	Maximum Reverse Recovery Current		-	22		Amps

THERMAL AND MECHANICAL CHARACTERISTICS

Symbol	Characteristic / Test Conditions	MIN	TYP	MAX	UNIT
$R_{\theta JC}$	Junction-to-Case Thermal Resistance			1.35	$^\circ C/W$
$R_{\theta JA}$	Junction-to-Ambient Thermal Resistance			80	
W_T	Package Weight		0.07		oz
			1.9		g
Torque	Maximum Mounting Torque			10	lb•in
				1.1	N•m

Microsemi Reserves the right to change, without notice, the specifications and information contained herein.

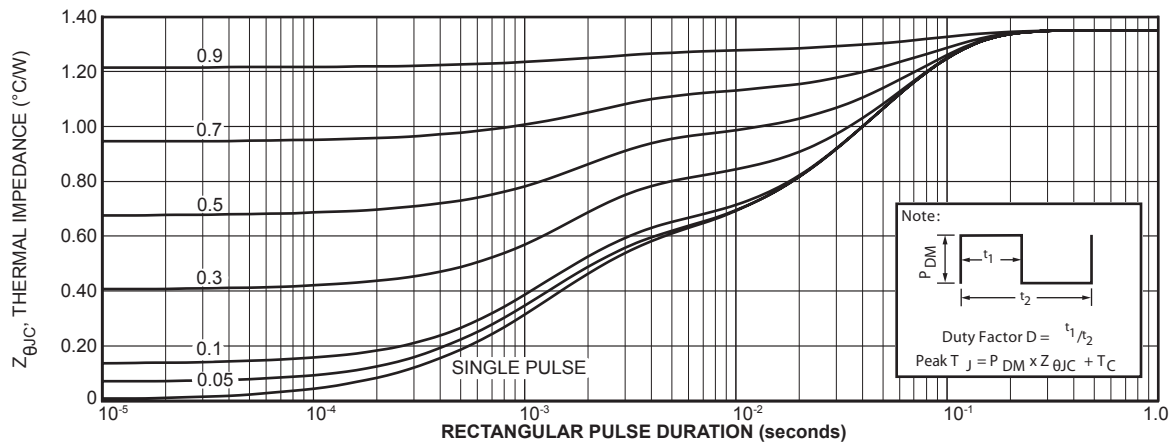

FIGURE 1. MAXIMUM EFFECTIVE TRANSIENT THERMAL IMPEDANCE, JUNCTION-TO-CASE vs. PULSE DURATION

TYPICAL PERFORMANCE CURVES

APT15D60K(G)

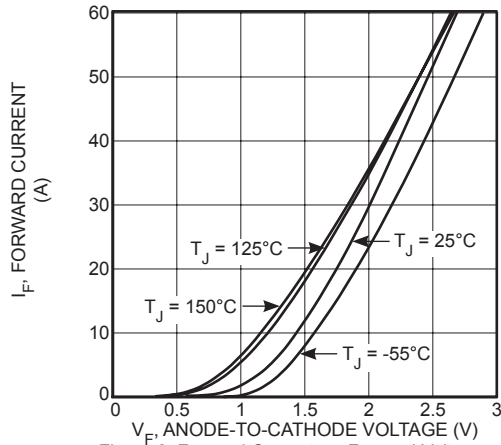

Figure 2. Forward Current vs. Forward Voltage

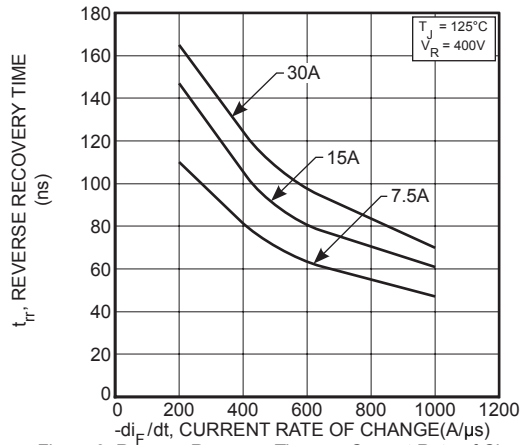

Figure 3. Reverse Recovery Time vs. Current Rate of Change

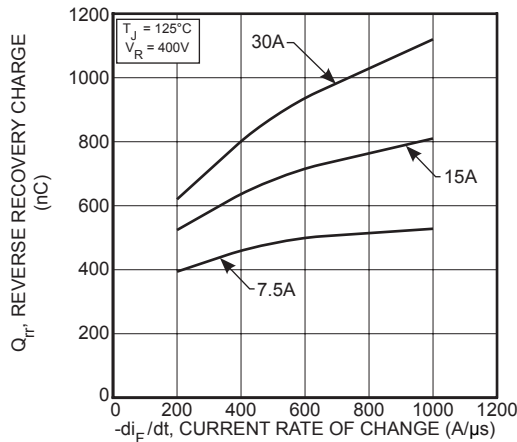

Figure 4. Reverse Recovery Charge vs. Current Rate of Change

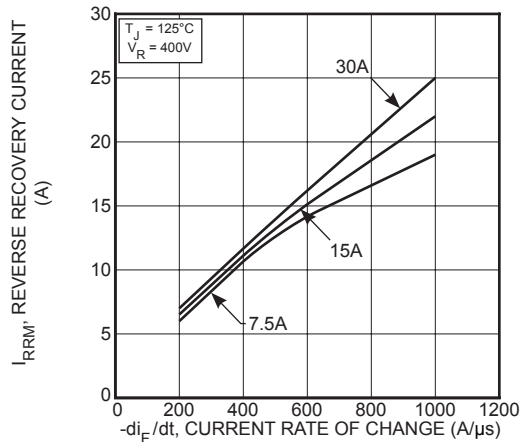

Figure 5. Reverse Recovery Current vs. Current Rate of Change

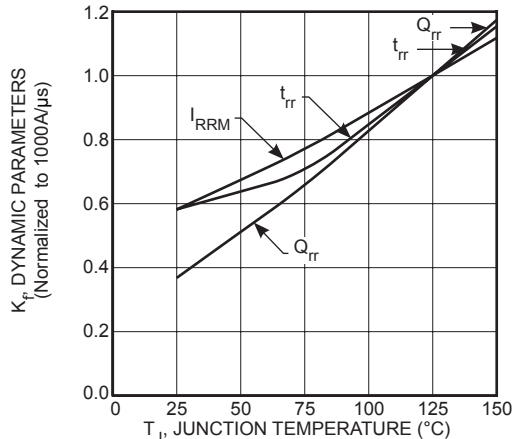

Figure 6. Dynamic Parameters vs. Junction Temperature

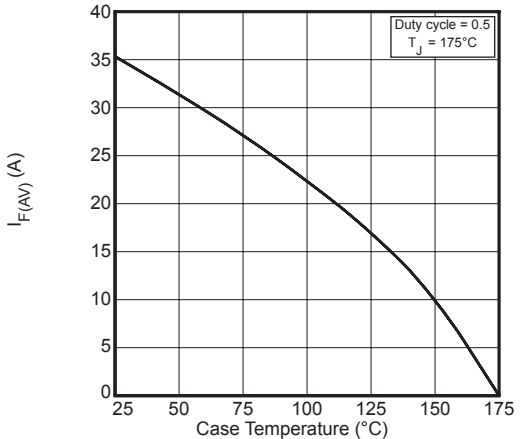

Figure 7. Maximum Average Forward Current vs. Case Temperature

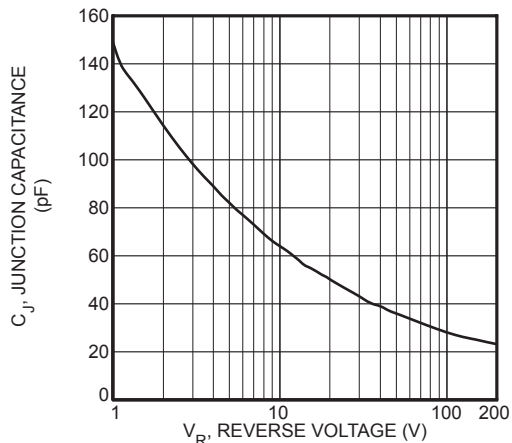

Figure 8. Junction Capacitance vs. Reverse Voltage

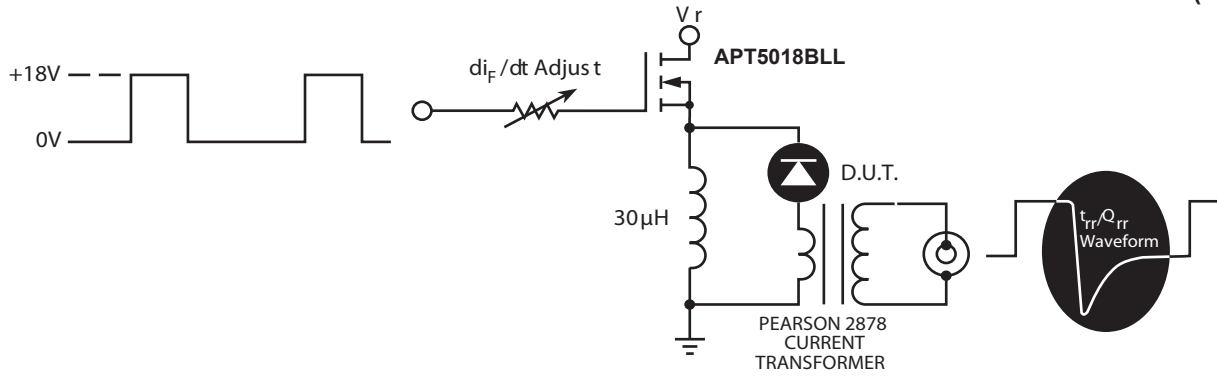

Figure 9. Diode Test Circuit

- 1 I_F - Forward Conduction Current
- 2 di_F/dt - Rate of Diode Current Change Through Zero Crossing.
- 3 I_{RRM} - Maximum Reverse Recovery Current
- 4 t_{rr} - Reverse Recovery Time measured from zero crossing where diode current goes from positive to negative, to the point at which the straight line through I_{RRM} and $0.25 I_{RRM}$ passes through zero.
- 5 Q_{rr} - Area Under the Curve Defined by I_{RRM} and t_{rr} .

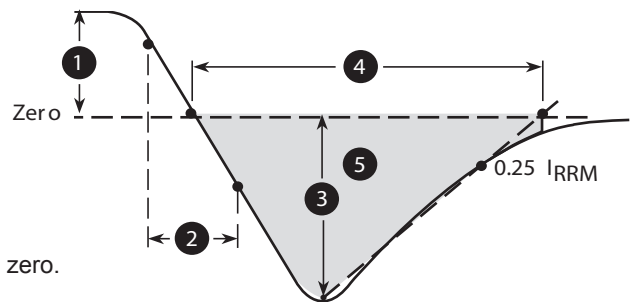
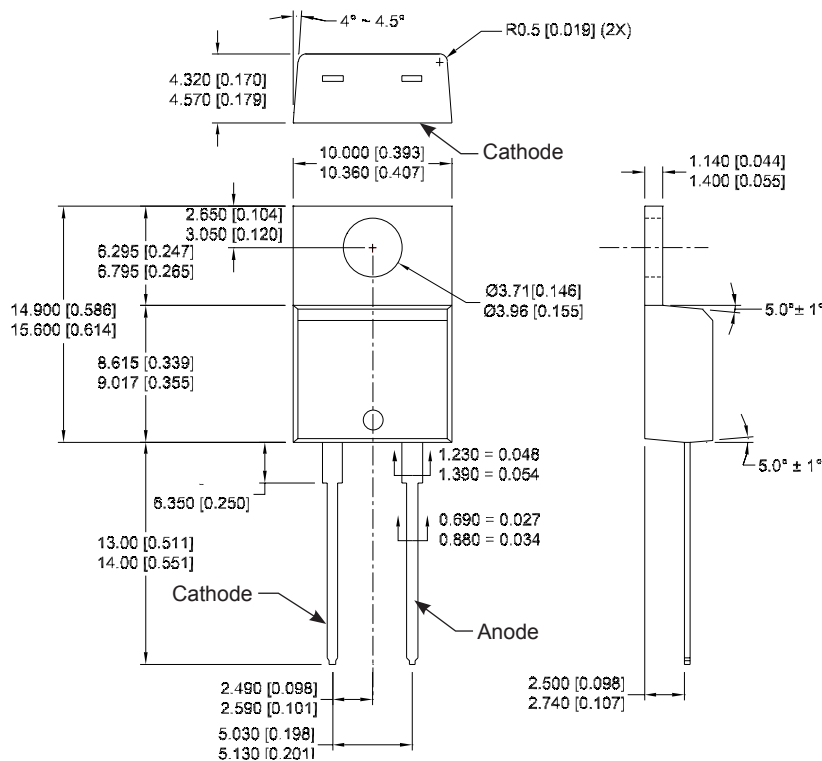

Figure 10. Diode Reverse Recovery Waveform Definition

TO-220 (K) Package Outline

e3 100% Sn



Dimensions in millimeters and [inches]

Disclaimer:

The information contained in the document (unless it is publicly available on the Web without access restrictions) is PROPRIETARY AND CONFIDENTIAL information of Microsemi and cannot be copied, published, uploaded, posted, transmitted, distributed or disclosed or used without the express duly signed written consent of Microsemi. If the recipient of this document has entered into a disclosure agreement with Microsemi, then the terms of such Agreement will also apply. This document and the information contained herein may not be modified, by any person other than authorized personnel of Microsemi. No license under any patent, copyright, trade secret or other intellectual property right is granted to or conferred upon you by disclosure or delivery of the information, either expressly, by implication, inducement, estoppels or otherwise. Any license under such intellectual property rights must be approved by Microsemi in writing signed by an officer of Microsemi.

Microsemi reserves the right to change the configuration, functionality and performance of its products at anytime without any notice. This product has been subject to limited testing and should not be used in conjunction with life-support or other mission-critical equipment or applications. Microsemi assumes no liability whatsoever, and Microsemi disclaims any express or implied warranty, relating to sale and/or use of Microsemi products including liability or warranties relating to fitness for a particular purpose, merchantability, or infringement of any patent, copyright or other intellectual property right. Any performance specifications believed to be reliable but are not verified and customer or user must conduct and complete all performance and other testing of this product as well as any user or customer's final application. User or customer shall not rely on any data and performance specifications or parameters provided by Microsemi. It is the customer's and user's responsibility to independently determine suitability of any Microsemi product and to test and verify the same. The information contained herein is provided "AS IS, WHERE IS" and with all faults, and the entire risk associated with such information is entirely with the User. Microsemi specifically disclaims any liability of any kind including for consequential, incidental and punitive damages as well as lost profit. The product is subject to other terms and conditions which can be located on the web at <http://www.microsemi.com/terms-a-conditions>.

Mouser Electronics

Authorized Distributor

Click to View Pricing, Inventory, Delivery & Lifecycle Information:

[Microchip:](#)

[APT15D60KG](#)