

---

# Keysight InfiniiVision 1200 X-Series and EDUX1052A/G Oscilloscopes

# Notices

© Keysight Technologies, Inc. 2005-2022

No part of this manual may be reproduced in any form or by any means (including electronic storage and retrieval or translation into a foreign language) without prior agreement and written consent from Keysight Technologies, Inc. as governed by United States and international copyright laws.

## Manual Part Number

N2137-97038

## Edition

Fifth edition, August 2022

Printed in Malaysia

Published by:

Keysight Technologies, Inc.  
1900 Garden of the Gods Road  
Colorado Springs, CO 80907 USA

## Print History

N2137-97000, September 2018

N2137-97012, January 2019

N2137-97015, January 2020

N2137-97027, September 2021

N2137-97038, August 2022

## Warranty

**The material contained in this document is provided "as is," and is subject to being changed, without notice, in future editions. Further, to the maximum extent permitted by applicable law, Keysight disclaims all warranties, either express or implied, with regard to this manual and any information contained herein, including but not limited to the implied warranties of merchantability and fitness for a particular purpose. Keysight shall not be liable for errors or for incidental or consequential damages in connection with the furnishing, use, or performance of this document or of any information contained herein. Should**

**Keysight and the user have a separate written agreement with warranty terms covering the material in this document that conflict with these terms, the warranty terms in the separate agreement shall control.**

## Technology License

The hardware and/or software described in this document are furnished under a license and may be used or copied only in accordance with the terms of such license.

## U.S. Government Rights

The Software is "commercial computer software," as defined by Federal Acquisition Regulation ("FAR") 2.101. Pursuant to FAR 12.212 and 27.405-3 and Department of Defense FAR Supplement ("DFARS") 227.7202, the U.S. government acquires commercial computer software under the same terms by which the software is customarily provided to the public. Accordingly, Keysight provides the Software to U.S. government customers under its standard commercial license, which is embodied in its End User License Agreement (EULA), a copy of which can be found at [www.keysight.com/find/sweula](http://www.keysight.com/find/sweula). The license set forth in the EULA represents the exclusive authority by which the U.S. government may use, modify, distribute, or disclose the Software. The EULA and the license set forth therein, does not require or permit, among other things, that Keysight: (1) Furnish technical information related to commercial computer software or commercial computer software documentation that is not customarily provided to the public; or (2) Relinquish to, or otherwise provide, the government rights in excess of these rights customarily provided to the public to use, modify, reproduce, release, perform, display, or disclose commercial computer software or commercial computer software documentation. No additional government requirements beyond those set forth in the

EULA shall apply, except to the extent that those terms, rights, or licenses are explicitly required from all providers of commercial computer software pursuant to the FAR and the DFARS and are set forth specifically in writing elsewhere in the EULA. Keysight shall be under no obligation to update, revise or otherwise modify the Software. With respect to any technical data as defined by FAR 2.101, pursuant to FAR 12.211 and 27.404.2 and DFARS 227.7102, the U.S. government acquires no greater than Limited Rights as defined in FAR 27.401 or DFAR 227.7103-5 (c), as applicable in any technical data.

## Safety Notices

### CAUTION

A **CAUTION** notice denotes a hazard. It calls attention to an operating procedure, practice, or the like that, if not correctly performed or adhered to, could result in damage to the product or loss of important data. Do not proceed beyond a **CAUTION** notice until the indicated conditions are fully understood and met.

## **WARNING**

A **WARNING** notice denotes a hazard. It calls attention to an operating procedure, practice, or the like that, if not correctly performed or adhered to, could result in personal injury or death. Do not proceed beyond a **WARNING** notice until the indicated conditions are fully understood and met.

---

# InfiniiVision 1200 X-Series and EDUX1052A/G Oscilloscopes— At a Glance



**Figure 1** InfiniiVision 1200 X-Series 4-Channel Oscilloscope



**Figure 2** InfiniiVision 1200 X-Series 2-Channel Oscilloscope

**Table 1** InfiniiVision 1200 X-Series and EDUX1052A/G Oscilloscopes Model Numbers, Bandwidths

Model:	EDUX1052A	EDUX1052G	DSOX1202A	DSOX1202G	DSOX1204A	DSOX1204G
Channels:	2				4	
Bandwidth:	50 MHz		70 MHz			
Bandwidth upgrades:			70 MHz to 100 MHz with D1202BW1A upgrade		70 MHz to 100 MHz with D1200BW1A upgrade	
			70 MHz to 200 MHz with D1202BW2A upgrade		70 MHz to 200 MHz with D1200BW2A upgrade	
			100 MHz to 200 MHz with D1202BW3A upgrade		100 MHz to 200 MHz with D1200BW3A upgrade	
Sampling rate:	1 GSa/s		2 GSa/s (interleaved), 1 GSa/s (non-interleaved)			
Memory:	200 kpts		2 Mpts (1 Mpts when the External Trig channel is on)		2 Mpts (interleaved), 1 Mpts (non-interleaved)	
Segmented memory:	No		Yes			

**Table 1** InfiniiVision 1200 X-Series and EDUX1052A/G Oscilloscopes Model Numbers, Bandwidths (continued)

Model:	EDUX1052A	EDUX1052G	DSOX1202A	DSOX1202G	DSOX1204A	DSOX1204G
Waveform generator:	No	Yes (20 MHz)	No	Yes (20 MHz)	No	Yes (20 MHz)
Mask/limit test:	No		Yes			

The Keysight InfiniiVision 1200 X-Series and EDUX1052A/G oscilloscopes deliver these features:

- 7 inch WVGA display.
- 200,000 waveforms/second update rate.
- All knobs are pushable for making quick selections.
- Trigger types: edge, pulse width, and video on EDUX1000-Series models. DSOX1200-Series models add: pattern, rise/fall time, and setup and hold.
- Serial decode/trigger options for: I<sup>2</sup>C and UART/RS232 on EDUX1000-Series models. DSOX1200-Series models add: CAN, LIN, and SPI.
- Math waveforms: add, subtract, multiply, divide, FFT (magnitude and phase), and low-pass filter.
- Reference waveforms (2) for comparing with other channel or math waveforms.
- Many built-in measurements.
- G-suffix models have built-in waveform generator with: sine, square, ramp, pulse, DC, noise.
- USB/LAN ports makes printing, saving, and sharing data easy.
- A Quick Help system is built into the oscilloscope. Press and hold any key to display Quick Help.

For more information about InfiniiVision oscilloscopes, see:

[www.keysight.com/find/scope](http://www.keysight.com/find/scope)

## In This Guide

This guide shows how to use the InfiniiVision 1200 X-Series and EDUX1052A/G oscilloscopes.

When unpacking and using the oscilloscope for the first time, see:	<ul style="list-style-type: none"><li>▪ <b>Chapter 1</b>, “Getting Started,” starting on page 21</li></ul>
When displaying waveforms and acquired data, see:	<ul style="list-style-type: none"><li>▪ <b>Chapter 2</b>, “Horizontal Controls,” starting on page 37</li><li>▪ <b>Chapter 3</b>, “Vertical Controls,” starting on page 47</li><li>▪ <b>Chapter 4</b>, “Analog Bus Display,” starting on page 55</li><li>▪ <b>Chapter 5</b>, “FFT Spectral Analysis,” starting on page 57</li><li>▪ <b>Chapter 6</b>, “Math Waveforms,” starting on page 65</li><li>▪ <b>Chapter 7</b>, “Reference Waveforms,” starting on page 77</li><li>▪ <b>Chapter 8</b>, “Serial Bus Decode/Trigger,” starting on page 81</li><li>▪ <b>Chapter 9</b>, “Display Settings,” starting on page 83</li><li>▪ <b>Chapter 10</b>, “Labels,” starting on page 91</li></ul>
When setting up triggers or changing how data is acquired, see:	<ul style="list-style-type: none"><li>▪ <b>Chapter 11</b>, “Triggers,” starting on page 97</li><li>▪ <b>Chapter 12</b>, “Trigger Mode/Coupling,” starting on page 121</li><li>▪ <b>Chapter 13</b>, “Acquisition Control,” starting on page 129</li></ul>
Making measurements and analyzing data:	<ul style="list-style-type: none"><li>▪ <b>Chapter 14</b>, “Cursors,” starting on page 145</li><li>▪ <b>Chapter 15</b>, “Measurements,” starting on page 155</li><li>▪ <b>Chapter 16</b>, “Mask Testing,” starting on page 181</li><li>▪ <b>Chapter 17</b>, “Digital Voltmeter,” starting on page 195</li><li>▪ <b>Chapter 18</b>, “Frequency Response Analysis,” starting on page 199</li></ul>
When using the built-in waveform generator, see:	<ul style="list-style-type: none"><li>▪ <b>Chapter 19</b>, “Waveform Generator,” starting on page 205</li></ul>
When saving, recalling, or printing, see:	<ul style="list-style-type: none"><li>▪ <b>Chapter 20</b>, “Save/Recall (Setups, Screens, Data),” starting on page 217</li><li>▪ <b>Chapter 21</b>, “Print (Screens),” starting on page 229</li></ul>

When using the oscilloscope's utility functions, see:	<ul style="list-style-type: none"> <li>▪ <a href="#">Chapter 22</a>, “Utility Settings,” starting on page 233</li> <li>▪ <a href="#">Chapter 23</a>, “Web Interface,” starting on page 251</li> </ul>
For reference information, see:	<ul style="list-style-type: none"> <li>▪ <a href="#">Chapter 24</a>, “Reference,” starting on page 263</li> </ul>
When using serial bus triggering and decode features, see:	<ul style="list-style-type: none"> <li>▪ <a href="#">Chapter 25</a>, “CAN Triggering and Serial Decode,” starting on page 277</li> <li>▪ <a href="#">Chapter 26</a>, “I2C Triggering and Serial Decode,” starting on page 287</li> <li>▪ <a href="#">Chapter 27</a>, “LIN Triggering and Serial Decode,” starting on page 295</li> <li>▪ <a href="#">Chapter 28</a>, “SPI Triggering and Serial Decode,” starting on page 303</li> <li>▪ <a href="#">Chapter 29</a>, “UART/RS232 Triggering and Serial Decode,” starting on page 315</li> </ul>

## NOTE

### Abbreviated instructions for pressing a series of keys and softkeys

Instructions for pressing a series of keys are written in an abbreviated manner. Instructions for pressing **[Key1]**, then pressing **Softkey2**, then pressing **Softkey3** are abbreviated as follows:

Press **[Key1]> Softkey2 > Softkey3**.

The keys may be a front panel **[Key]** or a **Softkey**. Softkeys are the six keys located directly below the oscilloscope display.



# Contents

InfiniiVision 1200 X-Series and EDUX1052A/G Oscilloscopes—At a Glance / 4

In This Guide / 7

## 1 Getting Started

Inspect the Package Contents / 21

Power-On the Oscilloscope / 22

Connect Probes to the Oscilloscope / 23



Maximum input voltage at analog inputs / 23



Do not float the oscilloscope chassis / 23

Input a Waveform / 23

Recall the Default Oscilloscope Setup / 24

Use Autoscale / 24

Compensate Passive Probes / 25

Learn the Front Panel Controls and Connectors / 26

Front Panel Overlays for Different Languages / 33

Learn the Rear Panel Connectors / 33

Learn the Oscilloscope Display / 34

Access the Built-In Quick Help / 36

Select the User Interface Language / 36

## 2 Horizontal Controls

- To adjust the horizontal (time/div) scale / 38
- To adjust the horizontal delay (position) / 39
- Panning and Zooming Single or Stopped Acquisitions / 40
- To change the horizontal time mode (Normal, XY, or Roll) / 40
  - XY Time Mode / 41
- To display the zoomed time base / 44
- To change the horizontal scale knob's coarse/fine adjustment setting / 45
- To position the time reference (left, center, right) / 46

## 3 Vertical Controls

- To turn waveforms on or off (channel or math) / 49
- To adjust the vertical scale / 49
- To adjust the vertical position / 49
- To specify channel coupling / 50
- To specify bandwidth limiting / 50
- To change the vertical scale knob's coarse/fine adjustment setting / 51
- To invert a waveform / 51
- Setting Analog Channel Probe Options / 51
  - To specify the channel units / 52
  - To specify the probe attenuation / 52
  - To specify the probe skew / 53

## 4 Analog Bus Display

## 5 FFT Spectral Analysis

FFT Measurement Hints / 60

FFT Units / 61

FFT DC Value / 61

FFT Aliasing / 62

FFT Spectral Leakage / 63

## 6 Math Waveforms

To display math waveforms / 66

To perform a math function on an arithmetic operation / 67

To adjust the math waveform scale and offset / 67

Units for Math Waveforms / 67

Math Operators / 68

Add or Subtract / 68

Multiply or Divide / 69

Math Transforms / 70

FFT Magnitude, FFT Phase / 70

Math Filters / 74

Low Pass Filter / 74

## 7 Reference Waveforms

To save a waveform to a reference waveform location / 77

To display a reference waveform / 78

To scale and position reference waveforms / 79

To adjust reference waveform skew / 79

To display reference waveform information / 80

To save/recall reference waveform files to/from a USB storage device / 80

## 8 Serial Bus Decode/Trigger

## 9 Display Settings

To adjust waveform intensity / 83

To set or clear persistence / 85

To clear the display / 86

To select the grid type / 86

To adjust the grid intensity / 87

To add an annotation / 87

To freeze the display / 89

## 10 Labels

To turn the label display on or off / 91

To assign a predefined label to a channel / 92

To define a new label / 93

To load a list of labels from a text file you create / 94

To reset the label library to the factory default / 95

## 11 Triggers

Adjusting the Trigger Level / 99

Forcing a Trigger / 99

Edge Trigger / 99

Pulse Width Trigger / 102

Pattern Trigger / 104

Rise/Fall Time Trigger / 106

Setup and Hold Trigger / 107

Video Trigger / 108

To trigger on a specific line of video / 112

To trigger on all sync pulses / 113

To trigger on a specific field of the video signal / 114

To trigger on all fields of the video signal / 115

To trigger on odd or even fields / 116

Serial Trigger / 118

## 12 Trigger Mode/Coupling

To select the Auto or Normal trigger mode / 122

To select the trigger coupling / 124

To enable or disable trigger noise rejection / 125

To enable or disable trigger HF Reject / 125

To set the trigger holdoff / 126

External Trigger Input / 127

## 13 Acquisition Control

Running, Stopping, and Making Single Acquisitions (Run Control) / 129

Overview of Sampling / 130

Sampling Theory / 131

Aliasing / 131

Oscilloscope Bandwidth and Sample Rate / 131

Oscilloscope Rise Time / 133

Oscilloscope Bandwidth Required / 134

Memory Depth and Sample Rate / 134

Selecting the Acquisition Mode / 135

Normal Acquisition Mode / 136

Peak Detect Acquisition Mode / 136

- Averaging Acquisition Mode / 138
- High Resolution Acquisition Mode / 140
- Acquiring to Segmented Memory / 141
  - Navigating Segments / 142
  - Infinite Persistence with Segmented Memory / 142
  - Segmented Memory Re-Arm Time / 142
  - Saving Data from Segmented Memory / 143

## 14 Cursors

- To make cursor measurements / 146
- Cursor Examples / 150

## 15 Measurements

- To make automatic measurements / 156
- Measurements Summary / 157
  - Snapshot All / 159
- Voltage Measurements / 160
  - Peak-Peak / 160
  - Maximum / 160
  - Minimum / 161
  - Amplitude / 161
  - Top / 161
  - Base / 162
  - Overshoot / 162
  - Preshoot / 163
  - Average / 164
  - DC RMS / 164
  - AC RMS / 165
- Time Measurements / 167
  - Period / 167
  - Frequency / 168

Counter	/	169
+ Width	/	169
- Width	/	169
Bit Rate	/	169
Duty Cycle	/	170
Rise Time	/	170
Fall Time	/	170
Delay	/	170
Phase	/	171
X at Min Y	/	173
X at Max Y	/	173
Count Measurements	/	174
Positive Pulse Count	/	174
Negative Pulse Count	/	174
Rising Edge Count	/	175
Falling Edges Count	/	175
Measurement Thresholds	/	175
Measurement Window with Zoom Display	/	177
Measurement Statistics	/	178

## 16 Mask Testing

To create a mask from a "golden" waveform (Automask)	/	181
Mask Test Setup Options	/	184
Mask Statistics	/	186
To manually modify a mask file	/	187
Building a Mask File	/	190
How is mask testing done?	/	193

## 17 Digital Voltmeter

## 18 Frequency Response Analysis

- To make connections / 199
- To set up and run the analysis / 200
- To view and save the analysis results / 202

## 19 Waveform Generator

- To select generated waveform types and settings / 205
- To specify the expected output load / 208
- To use waveform generator logic presets / 209
- To add noise to the waveform generator output / 209
- To add modulation to the waveform generator output / 210
  - To set up Amplitude Modulation (AM) / 211
  - To set up Frequency Modulation (FM) / 212
  - To set up Frequency-Shift Keying Modulation (FSK) / 214
- To restore waveform generator defaults / 215

## 20 Save/Recall (Setups, Screens, Data)

- Saving Setups, Screen Images, or Data / 217
  - To save setup files / 219
  - To save BMP or PNG image files / 219
  - To save CSV, ASCII XY, or BIN data files / 220
  - Length Control / 221
  - To save Lister data files / 222
  - To save reference waveform files to a USB storage device / 222
  - To save masks / 223
  - To navigate storage locations / 223
  - To enter file names / 224
- Recalling Setups, Masks, or Reference Waveforms / 224



- To recall setup files / 225
- To recall mask files / 225
- To recall reference waveform files from a USB storage device / 226

Recalling Default Setups / 226

Performing a Secure Erase / 226

## 21 Print (Screens)

To print the oscilloscope's display / 229

To set up network printer connections / 231

To specify the print options / 232

To specify the palette option / 232

## 22 Utility Settings

I/O Interface Settings / 233

Setting up the Oscilloscope's LAN Connection / 234

- To establish a LAN connection / 235

- Stand-alone (Point-to-Point) Connection to a PC / 236

File Explorer / 236

Setting Oscilloscope Preferences / 238

- To choose "expand about" center or ground / 239

- To disable/enable transparent backgrounds / 239

- To load the default label library / 239

- To set up the screen saver / 239

- To set Autoscale preferences / 241

Setting the Oscilloscope's Clock / 242

Setting the Gen Out Source / 242

Enabling Remote Command Logging / 243

Performing Service Tasks / 245

To perform user calibration	/ 245
To perform hardware self test	/ 246
To perform front panel self test	/ 246
To export crash log files	/ 246
To display oscilloscope information	/ 247
To display the user calibration status	/ 247
To clean the oscilloscope	/ 247
To check warranty and extended services status	/ 247
To contact Keysight	/ 248
To return the instrument	/ 248
Configuring the [Quick Action] Key	/ 248

## 23 Web Interface

Accessing the Web Interface	/ 252
Control Instrument	/ 253
Remote Front Panel	/ 254
Remote Programming via the Web Interface	/ 254
Remote Programming with Keysight IO Libraries	/ 256
Get Image	/ 256
Save/Recall	/ 257
Saving Files via the Web Interface	/ 257
Recalling Files via the Web Interface	/ 258
Identification Function	/ 259
Instrument Utilities	/ 260
Setting a Password	/ 261

## 24 Reference

Specifications and Characteristics	/ 263
Measurement Category	/ 263
Oscilloscope Measurement Category	/ 263

Measurement Category Definitions / 264

Maximum Input Voltages / 264



Maximum input voltage at analog inputs / 264

Environmental Conditions / 265

Declaration of Conformity / 265

Probes and Accessories / 265

Software and Firmware Updates / 266

Binary Data (.bin) Format / 266

Binary Data in MATLAB / 267

Binary Header Format / 267

Example Program for Reading Binary Data / 270

Examples of Binary Files / 270

CSV and ASCII XY files / 273

CSV and ASCII XY file structure / 274

Minimum and Maximum Values in CSV Files / 274

Acknowledgements / 275

Product Markings and Regulatory Information / 275

## 25 CAN Triggering and Serial Decode

Setup for CAN Signals / 277

CAN Triggering / 279

CAN Serial Decode / 281

Interpreting CAN Decode / 282

CAN Totalizer / 283

Interpreting CAN Lister Data / 284

## 26 I2C Triggering and Serial Decode

Setup for I2C Signals / 287

- I2C Triggering / 288
- I2C Serial Decode / 292
  - Interpreting I2C Decode / 293
  - Interpreting I2C Lister Data / 294

## 27 LIN Triggering and Serial Decode

- Setup for LIN Signals / 295
- LIN Triggering / 297
- LIN Serial Decode / 299
  - Interpreting LIN Decode / 301
  - Interpreting LIN Lister Data / 302

## 28 SPI Triggering and Serial Decode

- Setup for SPI Signals / 303
- SPI Triggering / 309
- SPI Serial Decode / 311
  - Interpreting SPI Decode / 313
  - Interpreting SPI Lister Data / 314

## 29 UART/RS232 Triggering and Serial Decode

- Setup for UART/RS232 Signals / 315
- UART/RS232 Triggering / 317
- UART/RS232 Serial Decode / 320
  - Interpreting UART/RS232 Decode / 322
  - UART/RS232 Totalizer / 323
  - Interpreting UART/RS232 Lister Data / 324

## Index

# 1 Getting Started

Inspect the Package Contents /	21
Power-On the Oscilloscope /	22
Connect Probes to the Oscilloscope /	23
Input a Waveform /	23
Recall the Default Oscilloscope Setup /	24
Use Autoscale /	24
Compensate Passive Probes /	25
Learn the Front Panel Controls and Connectors /	26
Learn the Rear Panel Connectors /	33
Learn the Oscilloscope Display /	34
Access the Built-In Quick Help /	36
Select the User Interface Language /	36

This chapter describes the steps you take when using the oscilloscope for the first time.

## Inspect the Package Contents

- Inspect the shipping container for damage.  
If your shipping container appears to be damaged, keep the shipping container or cushioning material until you have inspected the contents of the shipment for completeness and have checked the oscilloscope mechanically and electrically.
- Verify that you received the following items and any optional accessories you may have ordered:

- InfiniiVision 1200 X-Series or EDUX1052A/G oscilloscope.
- Power cord (country of origin determines specific type).
- Oscilloscope probes (one for each analog input channel).

## Power-On the Oscilloscope

- Power Requirements** Line voltage, frequency, and power:
- ~Line 100-120 Vac, 50/60/400 Hz
  - 100-240 Vac, 50/60 Hz
  - 50 W max

The oscilloscope tolerates mains supply voltage fluctuations up to  $\pm 10\%$  of the nominal voltage.

- Ventilation Requirements** The air intake and exhaust areas must be free from obstructions. Unrestricted air flow is required for proper cooling. Always ensure that the air intake and exhaust areas are free from obstructions.

The fan draws air in from the left side and bottom of the oscilloscope and pushes it out behind the oscilloscope.

When using the oscilloscope in a bench-top setting, provide at least 2" clearance at the sides and 4" (100 mm) clearance above and behind the oscilloscope for proper cooling.

- To power-on the oscilloscope**
- 1 Connect the power cord to the rear of the oscilloscope, then to a suitable AC voltage source. Route the power cord so the oscilloscope's feet and legs do not pinch the cord.
  - 2 The oscilloscope automatically adjusts for input line voltages in the range 100 to 240 VAC. The provided line cord is matched to the country of origin.

### **WARNING**

**Always use a grounded power cord. Do not defeat the power cord ground.**


- 3 Press the power switch.

The power switch is located on the lower left corner of the front panel. The oscilloscope will perform a self-test and will be operational in a few seconds.

## Connect Probes to the Oscilloscope


- 1 Connect the oscilloscope probe to an oscilloscope input channel BNC connector.
- 2 Connect the probe's retractable hook tip to the point of interest on the circuit or device under test. Be sure to connect the probe ground lead to a ground point on the circuit.

### CAUTION

 Maximum input voltage at analog inputs  
150 Vrms, 200 Vpk

---

### CAUTION

 Do not float the oscilloscope chassis

Defeating the ground connection and "floating" the oscilloscope chassis will probably result in inaccurate measurements and may also cause equipment damage. The probe ground lead is connected to the oscilloscope chassis and the ground wire in the power cord. If you need to measure between two live points, use a differential probe with sufficient dynamic range.

---

### WARNING

**Do not negate the protective action of the ground connection to the oscilloscope. The oscilloscope must remain grounded through its power cord. Defeating the ground creates an electric shock hazard.**

---

## Input a Waveform

The Probe Comp signal is used for compensating probes.

- 1 Connect an oscilloscope probe from channel 1 to the **Demo, Probe Comp** terminal on the front panel.
- 2 Connect the probe's ground lead to the ground terminal (next to the **Demo** terminal).

**WARNING**

**A voltage source should never be connected to the ground terminal of this instrument. If, for any reason, the Protective Conductor Terminal is disconnected or not functioning properly and a voltage source is connected to the equipment's ground terminals, the entire chassis will be at the voltage potential of the voltage source, and the operator or bystanders could receive an electric shock.**

---

## Recall the Default Oscilloscope Setup

To recall the default oscilloscope setup:

- 1 Press **[Default Setup]**.

The default setup restores the oscilloscope's default settings. This places the oscilloscope in a known operating condition.

In the Save/Recall menu, there are also options for restoring the complete factory settings or performing a secure erase (see **Chapter 20**, “Save/Recall (Setups, Screens, Data),” starting on page 217).

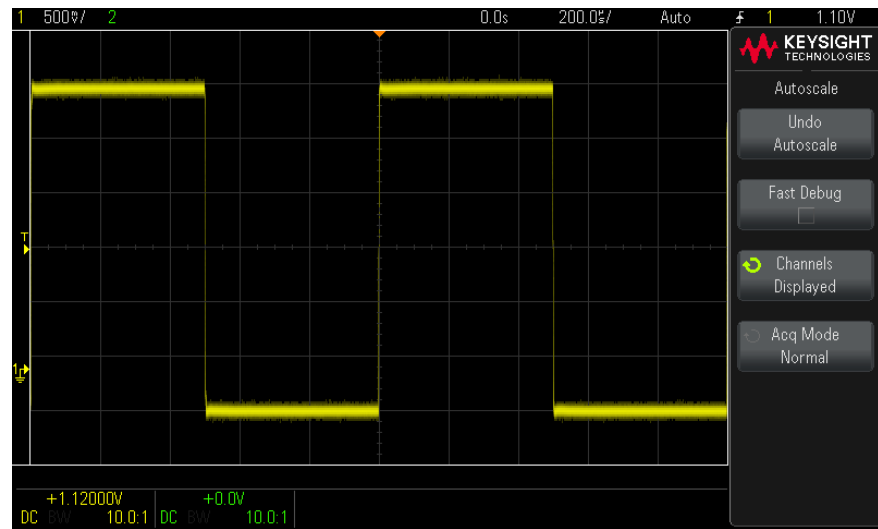
## Use Autoscale

Use **[Auto Scale]** to automatically configure the oscilloscope to best display the input signals.

- 1 Press **[Auto Scale]**.

You should see a waveform on the oscilloscope's display similar to this:





- 2 If you want to return to the oscilloscope settings that existed before, press **Undo Autoscale**.
- 3 If you want to enable "fast debug" autoscaling, change the channels autoscaled, or preserve the acquisition mode during autoscale, press **Fast Debug**, **Channels**, or **Acq Mode**.

These are the same softkeys that appear in the Autoscale Preferences menu. See [Chapter 22](#), "Utility Settings," starting on page 233.

If you see the waveform, but the square wave is not shaped correctly as shown above, perform the procedure "[Compensate Passive Probes](#)" on page 25.

If you do not see the waveform, make sure the probe is connected securely to the front panel channel input BNC and to the Demo/Probe Comp terminal.

## Compensate Passive Probes

Each oscilloscope passive probe must be compensated to match the input characteristics of the oscilloscope channel to which it is connected. A poorly compensated probe can introduce significant measurement errors.

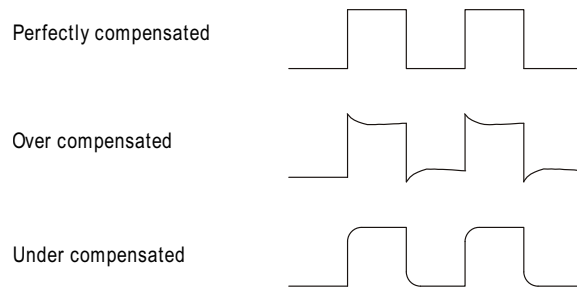
**NOTE**

If your probe has a configurable attenuation setting (like the N2140/42A probes do), the 10:1 setting must be used for probe compensation.

- 1 Input the Probe Comp signal (see **"Input a Waveform"** on page 23).
- 2 Press **[Default Setup]** to recall the default oscilloscope setup (see **"Recall the Default Oscilloscope Setup"** on page 24).
- 3 Press **[Auto Scale]** to automatically configure the oscilloscope for the Probe Comp signal (see **"Use Autoscale"** on page 24).
- 4 Press the channel key to which the probe is connected (**[1]**, **[2]**, etc.).
- 5 In the Channel menu, press **Probe**.
- 6 In the Channel Probe menu, press **Probe Check**; then, follow the instructions on-screen.

If necessary, use a nonmetallic tool (supplied with the probe) to adjust the trimmer capacitor on the probe for the flattest pulse possible.

On some probes (like the N2140/42A probes), the trimmer capacitor is located on the probe BNC connector. On other probes (like the N2862/63/90 probes), the trimmer capacitor is a yellow adjustment on the probe tip.



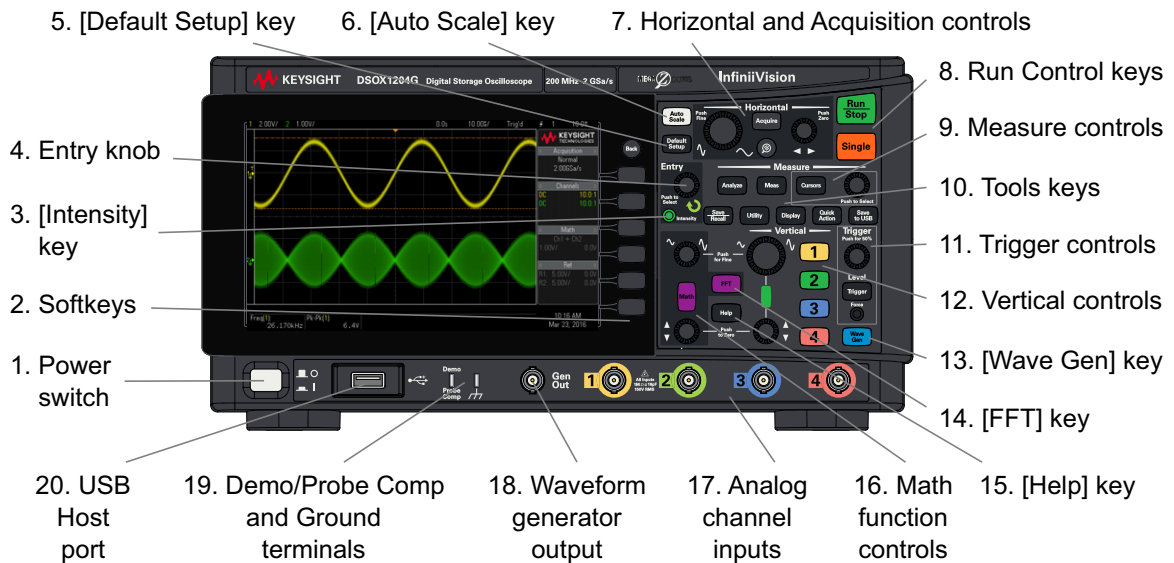
- 7 Connect probes to all other oscilloscope channels.
- 8 Repeat the procedure for each channel.

## Learn the Front Panel Controls and Connectors

On the front panel, *key* refers to any key (button) you can press.

*Softkey* specifically refers to the six keys next to the display. Menu and softkey labels appear on the display when other front panel keys are pressed. Softkey functions change as you navigate through the oscilloscope's menus.

For the following figures, refer to the numbered descriptions in the table that follows.






**Figure 3** InfiniiVision 1200 X-Series 4-Channel Oscilloscopes






21. [External] key



22. Ext Trig  
external trigger  
input


**Figure 4** InfiniiVision 1200 X-Series 2-Channel Oscilloscopes

1.	Power switch	Press once to switch power on; press again to switch power off. See <b>"Power-On the Oscilloscope"</b> on page 22.
2.	Softkeys	The functions of these keys change based upon the menus shown on the display next to the keys.  The  Back key moves back in the softkey menu hierarchy. At the top of the hierarchy, the  Back key turns the menus off, and oscilloscope information is shown instead.
3.	[Intensity] key	Press the key to illuminate it. When illuminated, turn the Entry knob to adjust waveform intensity. You can vary the intensity control to bring out signal detail, much like an analog oscilloscope.
4.	Entry knob	The Entry knob is used to select items from menus and to change values. The function of the Entry knob changes based upon the current menu and softkey selections.  Note that when the Entry knob  symbol appears on a softkey, you can use the Entry knob, to select values.  Often, rotating the Entry knob is enough to make a selection. Sometimes, you can push the Entry knob to enable or disable a selection. Also, pushing the Entry knob can also make popup menus disappear.

5.	<b>[Default Setup]</b> key	Press this key to restore the oscilloscope's default settings (details on " <b>Recall the Default Oscilloscope Setup</b> " on page 24).
6.	<b>[Auto Scale]</b> key	When you press the <b>[Auto Scale]</b> key, the oscilloscope will quickly determine which channels have activity, and it will turn these channels on and scale them to display the input signals. See " <b>Use Autoscale</b> " on page 24.
7.	Horizontal and Acquisition controls	<p>The Horizontal and Acquisition controls consist of:</p> <ul style="list-style-type: none"> <li>▪ Horizontal scale knob – Turn the knob in the Horizontal section that is marked  to adjust the time/div setting. The symbols under the knob indicate that this control has the effect of spreading out or zooming in on the waveform using the horizontal scale. Push the horizontal scale knob to toggle between fine and coarse adjustment.</li> <li>▪ Horizontal position knob – Turn the knob marked ◀▶ to pan through the waveform data horizontally. You can see the captured waveform before the trigger (turn the knob clockwise) or after the trigger (turn the knob counterclockwise). If you pan through the waveform when the oscilloscope is stopped (not in Run mode) then you are looking at the waveform data from the last acquisition taken.</li> <li>▪ <b>[Acquire]</b> key – Press this key to open the Acquire menu where you can select the Normal, XY, and Roll time modes, enable or disable Zoom, and select the trigger time reference point. Also you can select the Normal, Peak Detect, Averaging, or High Resolution acquisition modes and, on DSOX1200-Series models, use segmented memory (see "<b>Selecting the Acquisition Mode</b>" on page 135).</li> <li>▪ Zoom  key – Press the  zoom key to split the oscilloscope display into Normal and Zoom sections without opening the Acquire menu.</li> </ul> <p>For more information see <b>Chapter 2</b>, "Horizontal Controls," starting on page 37.</p>
8.	Run Control keys	<p>When the <b>[Run/Stop]</b> key is green, the oscilloscope is running, that is, acquiring data when trigger conditions are met. To stop acquiring data, press <b>[Run/Stop]</b>.</p> <p>When the <b>[Run/Stop]</b> key is red, data acquisition is stopped. To start acquiring data, press <b>[Run/Stop]</b>.</p> <p>To capture and display a single acquisition (whether the oscilloscope is running or stopped), press <b>[Single]</b>. The <b>[Single]</b> key is yellow until the oscilloscope triggers.</p> <p>For more information, see "<b>Running, Stopping, and Making Single Acquisitions (Run Control)</b>" on page 129.</p>

9.	Measure controls	<p>The measure controls consist of:</p> <ul style="list-style-type: none"> <li>▪ <b>[Analyze]</b> key – Press this key to access analysis features like: <ul style="list-style-type: none"> <li>▪ Trigger level setting.</li> <li>▪ Measurement threshold setting.</li> <li>▪ Video trigger automatic set up and display.</li> <li>▪ Display a bus made up of the analog channel inputs where channel 1 is the least significant bit and channel 4 is the most significant bit. See also <b>Chapter 4</b>, “Analog Bus Display,” starting on page 55.</li> <li>▪ Enable serial bus decodes. See also <b>Chapter 8</b>, “Serial Bus Decode/Trigger,” starting on page 81.</li> <li>▪ Reference waveforms (see <b>Chapter 7</b>, “Reference Waveforms,” starting on page 77).</li> <li>▪ Mask testing (see <b>Chapter 16</b>, “Mask Testing,” starting on page 181).</li> <li>▪ Digital voltmeter (see <b>Chapter 17</b>, “Digital Voltmeter,” starting on page 195).</li> <li>▪ Frequency response analysis on models with a built-in waveform generator (see <b>Chapter 18</b>, “Frequency Response Analysis,” starting on page 199).</li> </ul> </li> <li>▪ <b>[Meas]</b> key – Press this key to access a set of predefined measurements. See <b>Chapter 15</b>, “Measurements,” starting on page 155.</li> <li>▪ <b>[Cursors]</b> key – Press this key to open a menu that lets you select the cursors mode and source.</li> <li>▪ Cursors knob – Push this knob select cursors from a popup menu. Then, after the popup menu closes (either by timeout or by pushing the knob again), rotate the knob to adjust the selected cursor position.</li> </ul>
10.	Tools keys	<p>The Tools keys consist of:</p> <ul style="list-style-type: none"> <li>▪ <b>[Save/Recall]</b> key – Press this key to save oscilloscope setups, screen images, waveform data, or mask files or to recall setups, mask files or reference waveforms. See <b>Chapter 20</b>, “Save/Recall (Setups, Screens, Data),” starting on page 217.</li> <li>▪ <b>[Utility]</b> key – Press this key to access the Utility menu, which lets you configure the oscilloscope's I/O settings, use the file explorer, set preferences, access the service menu, and choose other options. See <b>Chapter 22</b>, “Utility Settings,” starting on page 233.</li> <li>▪ <b>[Display]</b> key – Press this key to access the menu where you can enable persistence, adjust the display grid (graticule) intensity, label waveforms, add an annotation, and clear the display (see <b>Chapter 9</b>, “Display Settings,” starting on page 83).</li> <li>▪ <b>[Quick Action]</b> key – Press this key to perform the selected quick action: measure all snapshot, print, save, recall, freeze display. and more. See <b>“Configuring the [Quick Action] Key”</b> on page 248.</li> <li>▪ <b>[Save to USB]</b> key – Press this key to perform a quick save to a USB storage device.</li> </ul>

11.	Trigger controls	<p>The Trigger controls determine how the oscilloscope triggers to capture data. These controls consist of:</p> <ul style="list-style-type: none"> <li>▪ <b>Level knob</b> – Turn the Level knob to adjust the trigger level for a selected analog channel. Push the knob to set the level to the waveform's 50% value. If AC coupling is used, pushing the Level knob sets the trigger level to about 0 V.</li> </ul> <p>The position of the trigger level for the analog channel is indicated by the trigger level icon <b>T</b> (if the analog channel is on) at the far left side of the display. The value of the analog channel trigger level is displayed in the upper-right corner of the display.</p> <ul style="list-style-type: none"> <li>▪ <b>[Trigger]</b> key – Press this key to select the trigger type (edge, pulse width, video, etc.). See <b>Chapter 11</b>, “Triggers,” starting on page 97. You can also set options that affect all trigger types. See <b>Chapter 12</b>, “Trigger Mode/Coupling,” starting on page 121.</li> <li>▪ <b>[Force]</b> key – Causes a trigger (on anything) and displays the acquisition.</li> </ul> <p>This key is useful in the Normal trigger mode where acquisitions are made only when the trigger condition is met. In this mode, if no triggers are occurring (that is, the “Trig'd?” indicator is displayed), you can press <b>[Force]</b> to force a trigger and see what the input signals look like.</p>
12.	Vertical controls	<p>The Vertical controls consist of:</p> <ul style="list-style-type: none"> <li>▪ <b>Analog channel on/off keys</b> – Use these keys to switch a channel on or off, or to access a channel's menu in the softkeys. There is one channel on/off key for each analog channel.</li> <li>▪ <b>Vertical scale knob</b> – Use the knob marked  to change the vertical sensitivity (gain) for the selected analog input channel. Push the vertical scale knob to toggle between fine and coarse adjustment. The default mode for expanding the signal is about the ground level of the channel; however, you can change this to expand about the center of the display.</li> <li>▪ <b>Vertical position knob</b> – Use this knob to change the selected analog input channel waveform vertical position on the display. The voltage value momentarily displayed in the upper right portion of the display represents the voltage difference between the vertical center of the display and the ground level ( icon). It also represents the voltage at the vertical center of the display if vertical expansion is set to expand about ground.</li> </ul> <p>For more information, see <b>Chapter 3</b>, “Vertical Controls,” starting on page 47.</p>
13.	<b>[Wave Gen]</b> key	<p>On G-suffix models that have a built-in waveform generator, press this key to access waveform generator functions. See <b>Chapter 19</b>, “Waveform Generator,” starting on page 205.</p>
14.	<b>[FFT]</b> key	<p>Provides access to FFT spectrum analysis function. See <b>Chapter 5</b>, “FFT Spectral Analysis,” starting on page 57.</p>

15.	<b>[Help]</b> key	Opens the Help menu where you can display overview help topics, select the Language (see also <b>"Access the Built-In Quick Help"</b> on page 36), and select training signals that can be output on the Demo terminal.
16.	Math function controls	<p>The Math function controls consist of:</p> <ul style="list-style-type: none"> <li>▪ <b>[Math]</b> key – provides access to math (add, subtract, etc.) waveform functions. See <b>Chapter 6</b>, "Math Waveforms," starting on page 65.</li> <li>▪ Vertical scale knob – Use the knob marked  to change the vertical sensitivity (as with the analog channel vertical controls).</li> <li>▪ Vertical position knob – Use the knob to change a math function waveform's vertical position on the display (as with the analog channel vertical controls).</li> </ul>
17.	Analog channel inputs	<p>Attach oscilloscope probes or BNC cables to these BNC connectors.</p> <p>In the InfiniiVision 1200 X-Series oscilloscopes, the analog channel inputs have 1 MΩ impedance. Also, there is no automatic probe detection, so you must properly set the probe attenuation for accurate measurement results. See <b>"Setting Analog Channel Probe Options"</b> on page 51.</p>
18.	Waveform generator output	<p>On G-suffix models, the built-in waveform generator can output sine, square, ramp, pulse, DC, or noise on the Gen Out BNC. Press the <b>[Wave Gen]</b> key to set up the waveform generator. See <b>Chapter 19</b>, "Waveform Generator," starting on page 205.</p> <p>You can also send the trigger output signal or the mask test failure signal to the <b>Gen Out</b> BNC connector. See <b>"Setting the Gen Out Source"</b> on page 242.</p>
19.	Demo/Probe Comp, Ground terminals	<ul style="list-style-type: none"> <li>▪ Demo terminal – This terminal outputs the Probe Comp signal which helps you match a probe's input capacitance to the oscilloscope channel to which it is connected. See <b>"Compensate Passive Probes"</b> on page 25. The oscilloscope can also output demo or training signals on this terminal.</li> <li>▪ Ground terminal – Use the ground terminal for oscilloscope probes connected to the Demo/Probe Comp terminal. See the warning in <b>"Input a Waveform"</b> on page 23.</li> </ul>



20.	USB Host port	<p>This port is for connecting USB mass storage devices or printers to the oscilloscope.</p> <p>Connect a USB compliant mass storage device (flash drive, disk drive, etc.) to save or recall oscilloscope setup files and reference waveforms or to save data and screen images. See <a href="#">Chapter 20</a>, “Save/Recall (Setups, Screens, Data),” starting on page 217.</p> <p>To print, connect a USB compliant printer. For more information about printing see <a href="#">Chapter 21</a>, “Print (Screens),” starting on page 229.</p> <p>You can also use the USB port to update the oscilloscope's system software when updates are available.</p> <p><b>NOTE:</b> You must <b>Eject</b> a USB mass storage device before unplugging it; otherwise, the device will be marked as needing repair when connecting to a computer with the Windows operating system (even though there are no harmful effects to the device).</p> <p><b>CAUTION:</b> Do not connect a host computer to the oscilloscope's USB host port. A host computer sees the oscilloscope as a device, so connect the host computer to the oscilloscope's device port (on the rear panel). See <a href="#">"Learn the Rear Panel Connectors"</a> on page 33.</p>
21.	[External] key	Press this key to set external trigger input options. See <a href="#">"External Trigger Input"</a> on page 127.
22.	Ext Trig input	External trigger input BNC connector. See <a href="#">"External Trigger Input"</a> on page 127 for an explanation of this feature.

## Front Panel Overlays for Different Languages

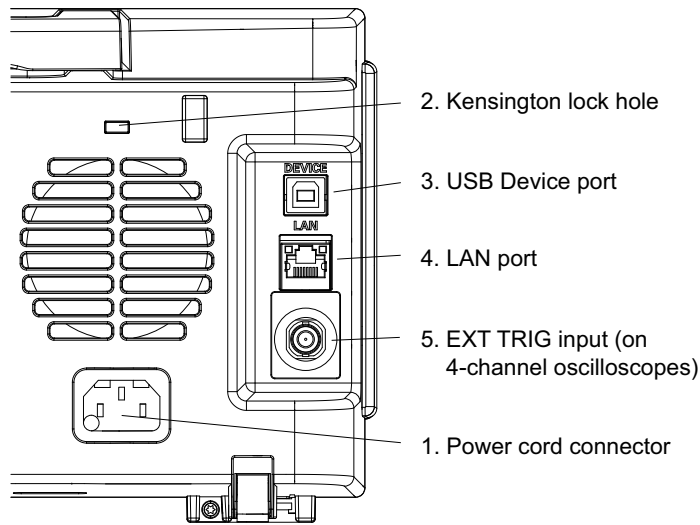
Front panel overlays, which have translations for the English front panel keys and label text, are available in many languages. The appropriate overlay is included when the localization option is chosen at time of purchase.

To install a front panel overlay:

- 1 Gently pull on the front panel knobs to remove them.
- 2 Insert the overlay's side tabs into the slots on the front panel.
- 3 Reinstall the front panel knobs.

## Learn the Rear Panel Connectors

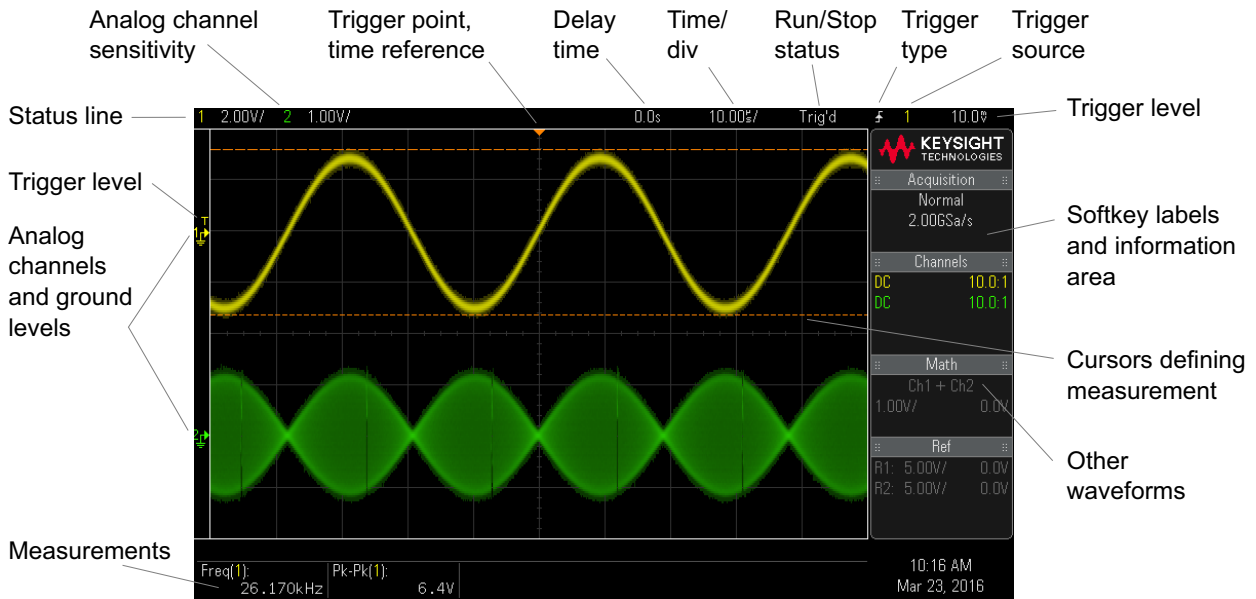
For the following figure, refer to the numbered descriptions in the table that follows.



1.	Power cord connector	Attach the power cord here.
2.	Kensington lock hole	This is where you can attach a Kensington lock for securing the instrument.
3.	USB Device port	This port is for connecting the oscilloscope to a host PC. You can issue remote commands from a host PC to the oscilloscope via the USB device port (see the <i>Programmer's Guide</i> ).
4.	LAN port	When the oscilloscope is connected to a network (see " <a href="#">Setting up the Oscilloscope's LAN Connection</a> " on page 234), the LAN port lets you print to network printers (see <a href="#">Chapter 21</a> , "Print (Screens)," starting on page 229), access the oscilloscope's built-in web server (see <a href="#">Chapter 23</a> , "Web Interface," starting on page 251), and issue remote commands (see the <i>Programmer's Guide</i> ).
15.	EXT TRIG input	On 4-channel models, the external trigger input BNC connector is on the rear panel. On 2-channel models, the external trigger input BNC connector is on the front panel. See " <a href="#">External Trigger Input</a> " on page 127 for an explanation of this feature.



## Learn the Oscilloscope Display

The oscilloscope display contains acquired waveforms, setup information, measurement results, and the softkey definitions.



**Figure 5** Interpreting the oscilloscope display

Status line	The top line of the display contains vertical, horizontal, and trigger setup information.
Display area	The display area contains the waveform acquisitions, channel identifiers, and analog trigger, and ground level indicators. Each analog channel's information appears in a different color. Signal detail is displayed using 256 levels of intensity. For more information about display modes see <a href="#">Chapter 9</a> , "Display Settings," starting on page 83.

<p>Softkey labels and information area</p>	<p>When most front panel keys are pressed, short menu names and softkey labels appear in this area. The labels describe the softkey functions. Typically, softkeys let you set up additional parameters for the selected mode or menu.</p> <p>Pressing the  Back key returns through the menu hierarchy until softkey labels are off and the information area is displayed. The information area contains acquisition, analog channel, math function, and reference waveform information.</p> <p>You can also specify that softkey menus turn off automatically after a specified timeout period (<b>[Utility] &gt; Options &gt; Menu Timeout</b>).</p> <p>Pressing the  Back key when the information area is displayed returns to the most recent menu displayed.</p>
<p>Measurements area</p>	<p>When measurements or cursors are turned on, this area contains automatic measurement and cursor results.</p> <p>When measurements are turned off, this area displays additional status information describing channel offset and other configuration parameters.</p>

## Access the Built-In Quick Help

To view Quick Help:

- 1 Press and hold the key, softkey, or knob for which you would like to view help. Quick Help remains on the screen until another key is pressed or a knob is turned.

## Select the User Interface Language

To select the user interface and Quick Help language:

- 1 Press **[Help]**, then press the **Language** softkey.
- 2 Turn the Entry knob until the desired language is selected.

## 2 Horizontal Controls

To adjust the horizontal (time/div) scale / 38

To adjust the horizontal delay (position) / 39

Panning and Zooming Single or Stopped Acquisitions / 40

To change the horizontal time mode (Normal, XY, or Roll) / 40


To display the zoomed time base / 44

To change the horizontal scale knob's coarse/fine adjustment setting / 45

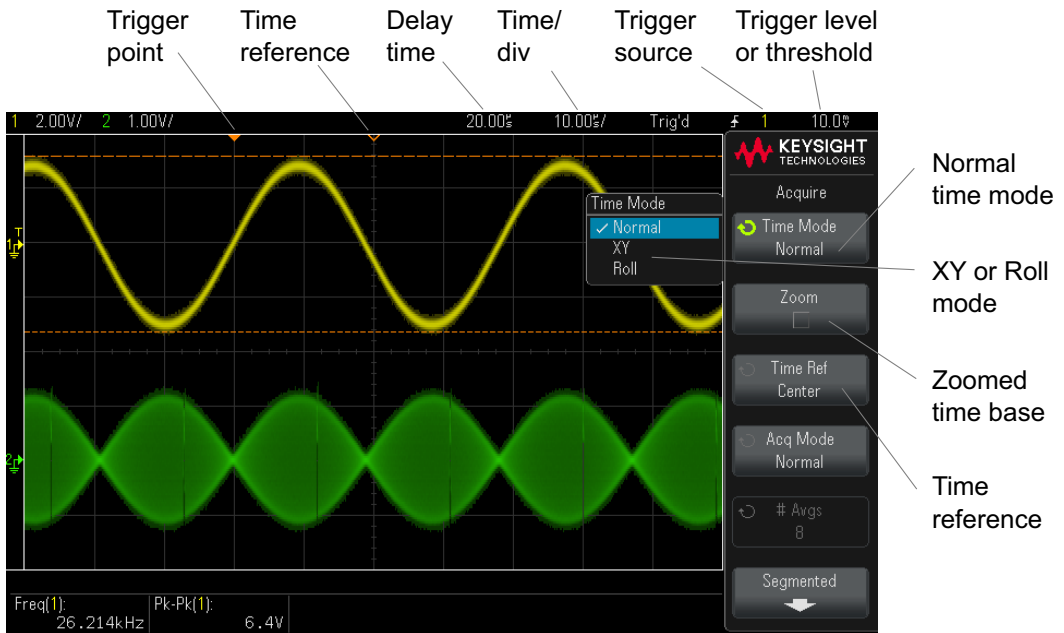
To position the time reference (left, center, right) / 46

The horizontal controls include:



- The horizontal scale and position knobs.
- The **[Acquire]** key for accessing the Acquire menu.
- The  zoom key for quickly enabling/disabling the split-screen zoom display.

The following figure shows the Acquire menu which appears after pressing the **[Acquire]** key.

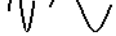


**Figure 6** Acquire Menu

The Acquire menu lets you select the time mode (Normal, XY, or Roll), enable Zoom, and specify the time reference.

The current sample rate is displayed in the right side information area when softkey menu labels are off.

## To adjust the horizontal (time/div) scale

- 1 Turn the large horizontal scale (sweep speed) knob marked  to change the horizontal time/div setting.

Notice how the time/div information in the status line changes.

The ▽ symbol at the top of the display indicates the time reference point.

The horizontal scale knob works (in the Normal time mode) while acquisitions are running or when they are stopped. When running, adjusting the horizontal scale knob changes the sample rate. When stopped, adjusting the horizontal scale knob lets you zoom into acquired data. See **"Panning and Zooming Single or Stopped Acquisitions"** on page 40.

Note that the horizontal scale knob has a different purpose in the Zoom display. See **"To display the zoomed time base"** on page 44.

## To adjust the horizontal delay (position)

- 1 Turn the horizontal delay (position) knob (◀▶).

The trigger point moves horizontally, pausing at 0.00 s (mimicking a mechanical detent), and the delay value is displayed in the status line.

Changing the delay time moves the trigger point (solid inverted triangle) horizontally and indicates how far it is from the time reference point (hollow inverted triangle ▽). These reference points are indicated along the top of the display grid.

**Figure 6** shows the trigger point with the delay time set to 200  $\mu$ s. The delay time number tells you how far the time reference point is located from the trigger point. When delay time is set to zero, the delay time indicator overlays the time reference indicator.

All events displayed left of the trigger point happened before the trigger occurred. These events are called pre-trigger information, and they show events that led up to the trigger point.

Everything to the right of the trigger point is called post-trigger information. The amount of delay range (pre-trigger and post-trigger information) available depends on the time/div selected and memory depth.

The horizontal position knob works (in the Normal time mode) while acquisitions are running or when they are stopped. When running, adjusting the horizontal scale knob changes the sample rate. When stopped, adjusting the horizontal scale knob lets you zoom into acquired data. See **"Panning and Zooming Single or Stopped Acquisitions"** on page 40.

Note that the horizontal position knob has a different purpose in the Zoom display. See **"To display the zoomed time base"** on page 44.

## Panning and Zooming Single or Stopped Acquisitions

When the oscilloscope is stopped, use the horizontal scale and position knobs to pan and zoom your waveform. The stopped display may contain several acquisitions worth of information, but only the last acquisition is available for pan and zoom.

The ability to pan (move horizontally) and scale (expand or compress horizontally) an acquired waveform is important because of the additional insight it can reveal about the captured waveform. This additional insight is often gained from seeing the waveform at different levels of abstraction. You may want to view both the big picture and the specific little picture details.

The ability to examine waveform detail after the waveform has been acquired is a benefit generally associated with digital oscilloscopes. Often this is simply the ability to freeze the display for the purpose of measuring with cursors or printing the screen. Some digital oscilloscopes go one step further by including the ability to further examine the signal details after acquiring them by panning through the waveform and changing the horizontal scale.

There is no limit imposed on the scaling ratio between the time/div used to acquire the data and the time/div used to view the data. There is, however, a useful limit. This useful limit is somewhat a function of the signal you are analyzing.

### NOTE

#### Zooming into stopped acquisitions

The screen will still contain a relatively good display if you zoom-in horizontally by a factor of 1000 and zoom-in vertically by a factor of 10 to display the information from where it was acquired. Remember that you can make automatic measurements on displayed data only.

---

## To change the horizontal time mode (Normal, XY, or Roll)

- 1 Press **[Acquire]**.
- 2 In the Acquire menu, press **Time Mode**; then, select:
  - **Normal** – the normal viewing mode for the oscilloscope.



In the Normal time mode, signal events occurring before the trigger are plotted to the left of the trigger point (▼) and signal events after the trigger plotted to the right of the trigger point.

- **XY** – XY mode changes the display from a volts-versus-time display to a volts-versus-volts display. The time base is turned off. Channel 1 amplitude is plotted on the X-axis and Channel 2 amplitude is plotted on the Y-axis.

You can use XY mode to compare frequency and phase relationships between two signals. XY mode can also be used with transducers to display strain versus displacement, flow versus pressure, volts versus current, or voltage versus frequency.

Use the cursors to make measurements on XY mode waveforms.

For more information about using XY mode for measurements, refer to "**XY Time Mode**" on page 41.

- **Roll** – causes the waveform to move slowly across the screen from right to left. It only operates on time base settings of 50 ms/div and slower. If the current time base setting is faster than the 50 ms/div limit, it will be set to 50 ms/div when Roll mode is entered.

In Roll mode there is no trigger. The fixed reference point on the screen is the right edge of the screen and refers to the current moment in time. Events that have occurred are scrolled to the left of the reference point. Since there is no trigger, no pre-trigger information is available.

If you would like to pause the display in Roll mode press the **[Single]** key. To clear the display and restart an acquisition in Roll mode, press the **[Single]** key again.

Use Roll mode on low-frequency waveforms to yield a display much like a strip chart recorder. It allows the waveform to roll across the display.

## XY Time Mode

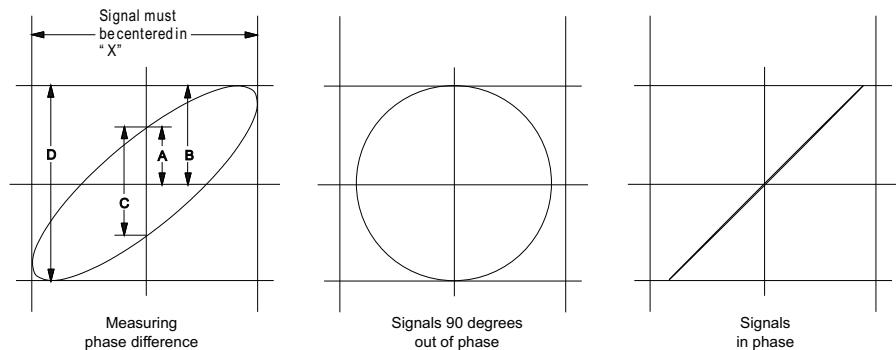
The XY time mode converts the oscilloscope from a volts-versus-time display to a volts-versus-volts display using two input channels. Channel 1 is the X-axis input, channel 2 is the Y-axis input. You can use various transducers so the display could show strain versus displacement, flow versus pressure, volts versus current, or voltage versus frequency.

**Example** This exercise shows a common use of the XY display mode by measuring the phase difference between two signals of the same frequency with the Lissajous method.

- 1 Connect a sine wave signal to channel 1, and a sine wave signal of the same frequency but out of phase to channel 2.
- 2 Press the **[Auto Scale]** key, press the **[Acquire]** key; then, press **Time Mode** and select "XY".
- 3 Center the signal on the display with the channel 1 and 2 position (◊) knobs. Use the channel 1 and 2 volts/div knobs and the channel 1 and 2 **Fine** softkeys to expand the signal for convenient viewing.

The phase difference angle ( $\theta$ ) can be calculated using the following formula (assuming the amplitude is the same on both channels):

$$\sin\theta = \frac{A}{B} \text{ or } \frac{C}{D}$$

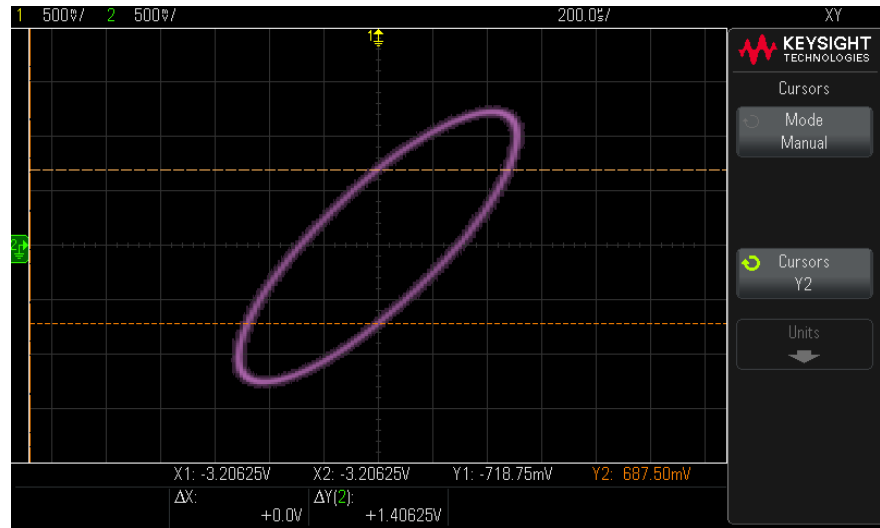


**Figure 7** XY time mode signals, centered on display

- 4 Press the **[Cursors]** key.
- 5 Set the Y2 cursor to the top of the signal, and set Y1 to the bottom of the signal.

Note the  $\Delta Y$  value at the bottom of the display. In this example, we are using the Y cursors, but you could have used the X cursors instead.

- 6 Move the Y1 and Y2 cursors to the intersection of the signal and the Y axis. Again, note the  $\Delta Y$  value.



**Figure 8** Phase difference measurements, automatic and using cursors

- 7 Calculate the phase difference using the formula below.

For example, if the first  $\Delta Y$  value is 1.688 and the second  $\Delta Y$  value is 1.031:

$$\sin\theta = \frac{\text{second } \Delta Y}{\text{first } \Delta Y} = \frac{1.031}{1.688}; \theta = 37.65 \text{ degrees of phase shift}$$

#### NOTE

#### Z-Axis Input in XY Display Mode (Blanking)

When you select the XY display mode, the time base is turned off. Channel 1 is the X-axis input, channel 2 is the Y-axis input, and the EXT TRIG input is the Z-axis input. If you only want to see portions of the Y versus X display, use the Z-axis input. Z-axis turns the trace on and off (analog oscilloscopes called this Z-axis blanking because it turned the beam on and off). When Z is low (<1.4 V), Y versus X is displayed; when Z is high (>1.4 V), the trace is turned off.

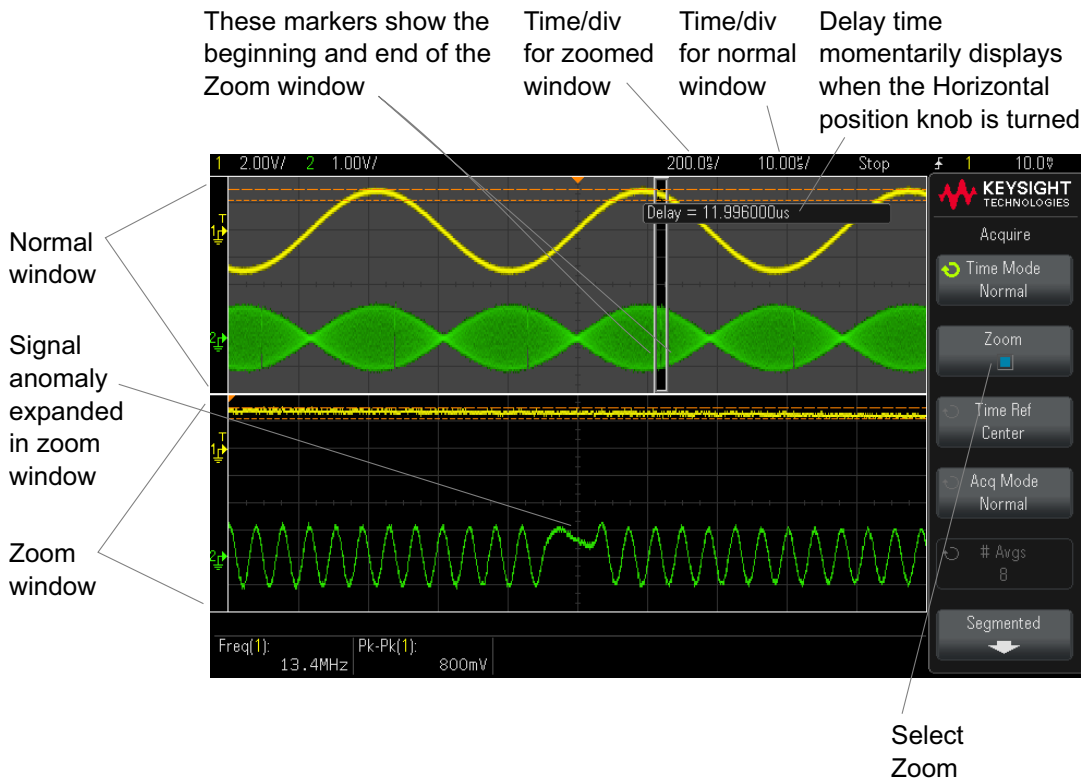
## To display the zoomed time base

Zoom, formerly called Delayed sweep mode, is a horizontally expanded version of the normal display. When Zoom is selected, the display divides in half. The top half of the display shows the normal time/div window and the bottom half displays a faster Zoom time/div window.

The Zoom window is a magnified portion of the normal time/div window. You can use Zoom to locate and horizontally expand part of the normal window for a more detailed (higher-resolution) analysis of signals.

To turn on (or off) Zoom:

- 1 Press the  zoom key (or press the **[Acquire]** key and then the **Zoom** softkey).



The area of the normal display that is expanded is outlined with a box and the rest of the normal display is ghosted. The box shows the portion of the normal sweep that is expanded in the lower half.

To change the time/div for the Zoom window, turn the horizontal scale (sweep speed) knob. As you turn the knob, the zoomed window time/div is highlighted in the status line above the waveform display area. The Horizontal scale (sweep speed) knob controls the size of the box.

The Horizontal position (delay time) knob sets the left-to-right position of the zoom window. The delay value, which is the time displayed relative to the trigger point) is momentarily displayed in the upper-right portion of the display when the delay time (◀▶) knob is turned.

Negative delay values indicate you're looking at a portion of the waveform before the trigger event, and positive values indicate you're looking at the waveform after the trigger event.

To change the time/div of the normal window, turn off Zoom; then, turn the horizontal scale (sweep speed) knob.

For information about using zoom mode for measurements, refer to ["To isolate a pulse for Top measurement"](#) on page 161 and ["To isolate an event for frequency measurement"](#) on page 168.

## To change the horizontal scale knob's coarse/fine adjustment setting

- 1 Push the horizontal scale knob to toggle between fine and coarse adjustment of the horizontal scale.

When **Fine** is enabled, turning the horizontal scale knob changes the time/div (displayed in the status line at the top of the display) in smaller increments. The time/div remains fully calibrated when **Fine** is on.

When **Fine** is turned off, the Horizontal scale knob changes the time/div setting in a 1-2-5 step sequence.

## To position the time reference (left, center, right)

Time reference is the reference point on the display for delay time (horizontal position).

**1** Press **[Acquire]**.

**2** In the Acquire menu, press **Time Ref**; then, select:

- **Left** – the time reference is set to one major division from the left edge of the display.
- **Center** – the time reference is set to the center of the display.
- **Right** – the time reference is set to one major division from the right edge of the display.

A small hollow triangle (▽) at the top of the display grid marks the position of the time reference. When delay time is set to zero, the trigger point indicator (▼) overlays the time reference indicator.

The time reference position sets the initial position of the trigger event within acquisition memory and on the display, with delay set to 0.

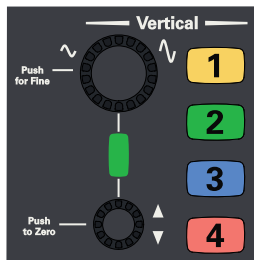
Turning the Horizontal scale (sweep speed) knob expands or contracts the waveform about the time reference point (▽). See "**To adjust the horizontal (time/div) scale**" on page 38.

Turning the Horizontal position (◀▶) knob in Normal mode (not Zoom) moves the trigger point indicator (▼) to the left or right of the time reference point (▽). See "**To adjust the horizontal delay (position)**" on page 39.

## 3 Vertical Controls

- To turn waveforms on or off (channel or math) / 49
- To adjust the vertical scale / 49
- To adjust the vertical position / 49
- To specify channel coupling / 50
- To specify bandwidth limiting / 50
- To change the vertical scale knob's coarse/fine adjustment setting / 51
- To invert a waveform / 51
- Setting Analog Channel Probe Options / 51

The vertical controls include:



- Multiplexed vertical scale and position knobs for the selected analog channel.
- The channel keys for turning a channel on or off and accessing the channel's softkey menu.

**NOTE**

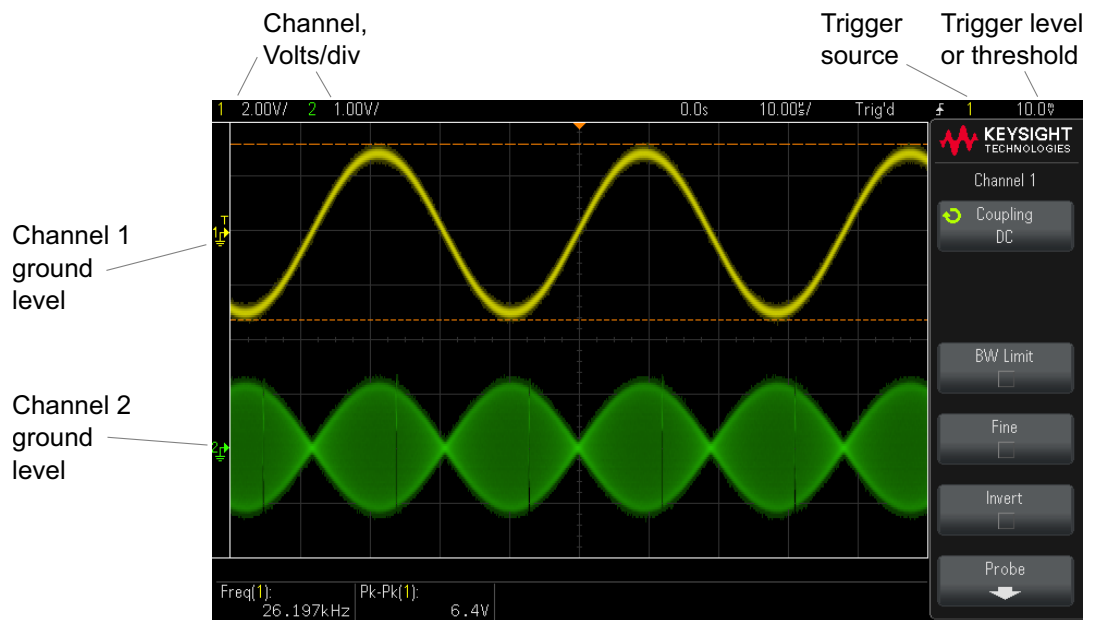
Keysight recommends always scaling the signal so that the entire waveform is contained between the top and bottom of the display.


For proper operation of the 1200 X-Series oscilloscope, the channel inputs must not be overdriven more than  $\pm 8$  divisions. Exceeding this limit may result in signals that appear incorrect and may increase crosstalk between the input channels.

**NOTE**

To minimize crosstalk between input channels, make sure the channel is not overdriven. Also, connecting a probe or cable to a channel will reduce crosstalk.

The following figure shows the Channel 1 menu that appears after pressing the [1] channel key.



The ground level of the signal for each displayed analog channel is identified by the position of the  icon at the far-left side of the display.



## To turn waveforms on or off (channel or math)

- 1 Press an analog channel key turn the channel on or off (and to display the channel's menu).


When a channel is on, its key is illuminated.

### NOTE

#### Turning channels off

You must be viewing the menu for a channel before you can turn it off. For example, if channel 1 and channel 2 are turned on and the menu for channel 2 is being displayed, to turn channel 1 off, press [1] to display the channel 1 menu; then, press [1] again to turn channel 1 off.

## To adjust the vertical scale

- 1 Turn the large knob above the channel key marked  to set the vertical scale (volts/division) for the channel.

The vertical scale knob changes the analog channel scale in a 1-2-5 step sequence (with a 1:1 probe attached) unless fine adjustment is enabled (see **"To change the vertical scale knob's coarse/fine adjustment setting"** on page 51).

The analog channel Volts/Div value is displayed in the status line.

The default mode for expanding the signal when you turn the volts/division knob is vertical expansion about the ground level of the channel; however, you can change this to expand about the center of the display. See **"To choose "expand about" center or ground"** on page 239.

## To adjust the vertical position

- 1 Turn the small vertical position knob (◆) to move the channel's waveform up or down on the display.

The voltage value momentarily displayed in the upper right portion of the display represents the voltage difference between the vertical center of the display and the ground level (⚡) icon. It also represents the voltage at the vertical center of the display if vertical expansion is set to expand about ground (see **"To choose 'expand about' center or ground"** on page 239).

## To specify channel coupling

Coupling changes the channel's input coupling to either **AC** (alternating current) or **DC** (direct current).

### TIP

If the channel is DC coupled, you can quickly measure the DC component of the signal by simply noting its distance from the ground symbol.

If the channel is AC coupled, the DC component of the signal is removed, allowing you to use greater sensitivity to display the AC component of the signal.

- 1 Press the desired channel key.
- 2 In the Channel menu, press the **Coupling** softkey to select the input channel coupling:
  - **DC** – DC coupling is useful for viewing waveforms as low as 0 Hz that do not have large DC offsets.
  - **AC** – AC coupling is useful for viewing waveforms with large DC offsets.

AC coupling places a 10 Hz high-pass filter in series with the input waveform that removes any DC offset voltage from the waveform.

Note that Channel Coupling is independent of Trigger Coupling. To change trigger coupling see **"To select the trigger coupling"** on page 124.

## To specify bandwidth limiting

- 1 Press the desired channel key.
- 2 In the Channel menu, press the **BW Limit** softkey to enable or disable bandwidth limiting.

When bandwidth limit is on, the maximum bandwidth for the channel is approximately 20 MHz. For waveforms with frequencies below this, turning bandwidth limit on removes unwanted high frequency noise from the waveform. The bandwidth limit also limits the trigger signal path of any channel that has **BW Limit** turned on.

## To change the vertical scale knob's coarse/fine adjustment setting

- 1 Push the channel's vertical scale knob (or press the channel key and then the **Fine** softkey in the Channel menu) to toggle between fine and coarse adjustment of the vertical scale.

When **Fine** adjustment is selected, you can change the channel's vertical sensitivity in smaller increments. The channel sensitivity remains fully calibrated when **Fine** is on.

The vertical scale value is displayed in the status line at the top of the display.

When **Fine** is turned off, turning the volts/division knob changes the channel sensitivity in a 1-2-5 step sequence.

## To invert a waveform

- 1 Press the desired channel key.
- 2 In the Channel menu, press the **Invert** softkey to invert the selected channel.

When **Invert** is selected, the voltage values of the displayed waveform are inverted.

Invert affects how a channel is displayed. However, when using basic triggers, the oscilloscope attempts to maintain the same trigger point by changing trigger settings.

Inverting a channel also changes the result of any math function selected in the waveform Math menu or any measurement.

## Setting Analog Channel Probe Options

- 1 Press the probe's associated channel key.

- 2 In the Channel menu, press the **Probe** softkey to display the Channel Probe menu.

The Channel Probe menu lets you select additional probe parameters such as attenuation factor and units of measurement for the connected probe.

The **Probe Check** softkey guides you through the process of compensating passive probes (such as the N2140A, N2142A, N2862A/B, N2863A/B, N2889A, N2890A, 10073C, 10074C, or 1165A probes).



- See Also
- ["To specify the channel units"](#) on page 52
  - ["To specify the probe attenuation"](#) on page 52
  - ["To specify the probe skew"](#) on page 53

### To specify the channel units


- 1 Press the probe's associated channel key.
- 2 In the Channel menu, press **Probe**.
- 3 In the Channel Probe menu, press **Units**; then, select:
  - **Volts** – for a voltage probe.
  - **Amps** – for a current probe.

Channel sensitivity, trigger level, measurement results, and math functions will reflect the measurement units you have selected.

### To specify the probe attenuation

The probe attenuation factor must be set properly for accurate measurement results.

To set the probe attenuation factor:

- 1 Press the channel key.
- 2 Press the **Probe** softkey until you have selected how you want to specify the attenuation factor, choosing either **Ratio** or **Decibels**.
- 3 Turn the Entry knob  to set the attenuation factor for the connected probe.

When measuring voltage values, the attenuation factor can be set from 0.100:1 to 10000:1 in a 1-2-5 sequence.

When measuring current values with a current probe, the attenuation factor can be set from 10.0 V/A to 0.0001 V/A.

When specifying the attenuation factor in decibels, you can select values from -20 dB to 80 dB.

If Amps is chosen as the units and a manual attenuation factor is chosen, then the units as well as the attenuation factor are displayed.

## To specify the probe skew

When measuring time intervals in the nanoseconds (ns) range, small differences in cable length can affect the measurement. Use **Skew** to remove cable-delay errors between any two channels.

- 1 Probe the same point with both probes.
- 2 Press one of the probes associated channel key.
- 3 In the Channel menu, press **Probe**.
- 4 In the Channel Probe menu, press **Skew**; then, select the desired skew value.

Each analog channel can be adjusted  $\pm 100$  ns for a total of 200 ns difference.

The skew setting is not affected by pressing **[Default Setup]** or **[Auto Scale]**.



## 4 Analog Bus Display

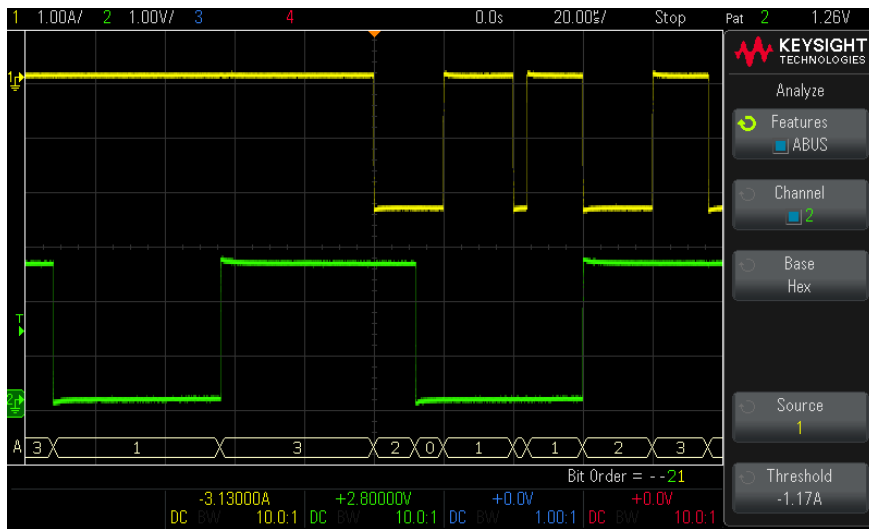
You can display a bus made up of the analog channel inputs and, on 2-channel oscilloscope models, the external trigger input. Any of the input channels can be assigned to the bus.

To display an analog bus:

- 1 Press the **[Analyze]** key.
- 2 Press **Features**; then, select **Analog Bus**.
- 3 Press **Features** again (or push the Entry knob) to enable the analog bus display.
- 4 To assign channels to the bus, press the **Channel** softkey, turn the Entry knob to select the channel, and then press **Channel** again to include or exclude the channel in the bus.
- 5 To specify the analog bus value number base, press **Base** and turn the Entry knob to select **Hex** or **Binary**.
- 6 To specify the channel threshold voltage levels, which determines 0 and 1 bit levels in the bus value, use the **Source** softkey and the Entry knob to select a channel, then use the **Threshold** softkey and Entry knob to specify its threshold voltage.

You can push the Entry knob to toggle between **Source** and **Threshold** softkey selection.

## 4 Analog Bus Display



The bus values display appears at the bottom of the graticule, above any serial bus waveforms (if present). Channel 1 is the least significant bit and channel 4 is the most significant bit.



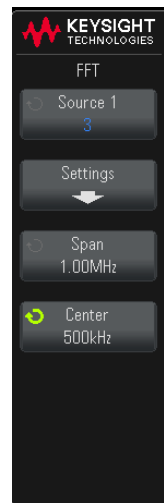
## 5 FFT Spectral Analysis

FFT is used to compute the fast Fourier transform of analog input signals. FFT takes the digitized time record of the specified source and transforms it to the frequency domain. When the FFT function is selected, the FFT spectrum is plotted on the oscilloscope display as magnitude in dBV versus frequency. The readout for the horizontal axis changes from time to frequency (Hertz) and the vertical readout changes from volts to dB.

Use the FFT function to find crosstalk problems, to find distortion problems in analog waveforms caused by amplifier non-linearity, or for adjusting analog filters.

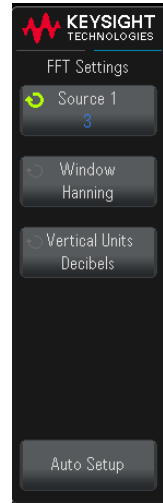
To display a FFT waveform:

- 1 Press the **[FFT]** key.
  - **Source 1** – selects the source for the FFT.
  - **Settings** – displays the FFT Settings menu.
  - **Span** – specifies the frequency range represented by the width of the display. Divide span by 10 to calculate the frequency scale per division.
  - **Center** – specifies the frequency at the center vertical grid line of the display.



2 Press the **Settings** softkey to display additional FFT settings.

- **Source 1** – selects the source for the FFT.
- **Window**– selects a window to apply to your FFT input signal:
  - **Hanning** – window for making accurate frequency measurements or for resolving two frequencies that are close together.
  - **Flat Top** – window for making accurate amplitude measurements of frequency peaks.
  - **Rectangular** – good frequency resolution and amplitude accuracy, but use only where there will be no leakage effects. Use on self-windowing waveforms such as pseudo-random noise, impulses, sine bursts, and decaying sinusoids.
  - **Blackman Harris** – window reduces time resolution compared to a rectangular window, but improves the capacity to detect smaller impulses due to lower secondary lobes.
- **Vertical Units** – lets you select **Decibels** or **V RMS** as the units for the FFT vertical scale.
- **Auto Setup** – sets the frequency Span and Center to values that will cause the entire available spectrum to be displayed. The maximum available frequency is half the FFT sample rate, which is a function of the time per division setting. The FFT resolution is the quotient of the sampling rate and the number of FFT points ( $f_s/N$ ). The current FFT Resolution is displayed.



## NOTE

### Scale and offset considerations

If you do not manually change the FFT scale or offset settings, when you turn the horizontal scale knob, the span and center frequency settings will automatically change to allow optimum viewing of the full spectrum.

If you do manually set scale or offset, turning the horizontal scale knob will not change the span or center frequency settings, allowing you see better detail around a specific frequency.

Pressing the FFT **Auto Setup** softkey will automatically rescale the waveform and span and center will again automatically track the horizontal scale setting.

- 3 To make cursor measurements, press the **[Cursors]** key and set the **Source** softkey to **Math N**.

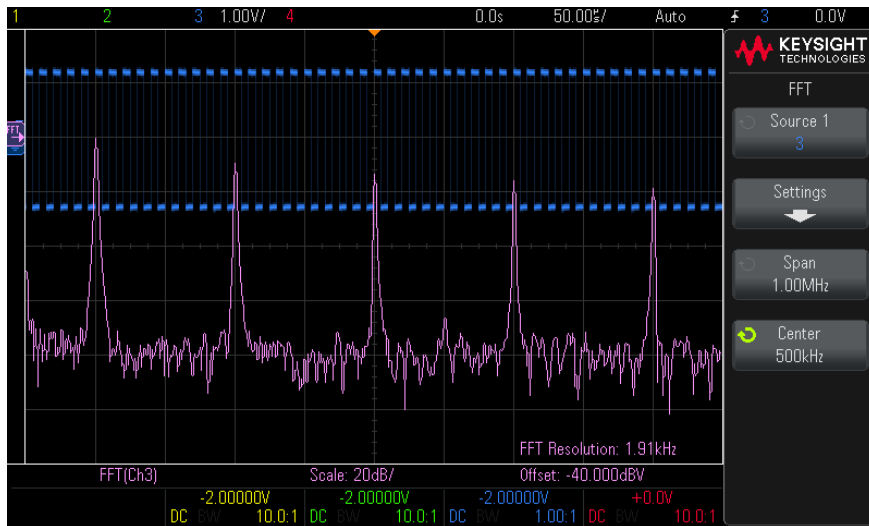
Use the X1 and X2 cursors to measure frequency values and difference between two frequency values ( $\Delta X$ ). Use the Y1 and Y2 cursors to measure amplitude in dB and difference in amplitude ( $\Delta Y$ ).

- 4 To make other measurements, press the **[Meas]** key and set the **Source** softkey to **Math N**.

You can make peak-to-peak, maximum, minimum, and average dB measurements on the FFT waveform. You can also find the frequency value at the first occurrence of the waveform maximum by using the X at Max Y measurement.

To adjust the FFT waveform scale and offset, use the multiplexed scale and position knobs next to the **[Math]** key to re-size and re-position the math waveform.

The following FFT spectrum was obtained by connecting a 2.5 V, 100 kHz square wave to channel 2. Set the horizontal scale to 50  $\mu\text{s}/\text{div}$ , vertical sensitivity to 1 V/div, Units/div to 20 dBV, Offset to -40.0 dBV, Center frequency to 500 kHz, frequency Span to 1 MHz, and window to Hanning.



See Also • ["FFT Measurement Hints"](#) on page 60

- "FFT Units" on page 61
- "FFT DC Value" on page 61
- "FFT Aliasing" on page 62
- "FFT Spectral Leakage" on page 63
- "Units for Math Waveforms" on page 67

## FFT Measurement Hints

The number of points acquired for the FFT record can be up to 65,536, and when frequency span is at maximum, all points are displayed. Once the FFT spectrum is displayed, the frequency span and center frequency controls are used much like the controls of a spectrum analyzer to examine the frequency of interest in greater detail. Place the desired part of the waveform at the center of the screen and decrease frequency span to increase the display resolution. As frequency span is decreased, the number of points shown is reduced, and the display is magnified.

While the FFT spectrum is displayed, use the **[Math]** and **[Cursors]** keys to switch between measurement functions and frequency domain controls in FFT menu.

### NOTE

#### FFT Resolution

The FFT resolution is the quotient of the sampling rate and the number of FFT points ( $f_s/N$ ). With a fixed number of FFT points (up to 65,536), the lower the sampling rate, the better the resolution.

Decreasing the effective sampling rate by selecting a greater time/div setting will increase the low frequency resolution of the FFT display and also increase the chance that an alias will be displayed. The resolution of the FFT is the effective sample rate divided by the number of points in the FFT. The actual resolution of the display will not be this fine as the shape of the window will be the actual limiting factor in the FFT's ability to resolve two closely spaced frequencies. A good way to test the ability of the FFT to resolve two closely spaced frequencies is to examine the sidebands of an amplitude modulated sine wave.

For the best vertical accuracy on peak measurements:

- Make sure the probe attenuation is set correctly. The probe attenuation is set from the Channel menu if the operand is a channel.

- Set the source sensitivity so that the input signal is near full screen, but not clipped.
- Use the Flat Top window.
- Set the FFT sensitivity to a sensitive range, such as 2 dB/division.

For best frequency accuracy on peaks:

- Use the Hanning window.
- Use Cursors to place an X cursor on the frequency of interest.
- Adjust frequency span for better cursor placement.
- Return to the Cursors menu to fine tune the X cursor.

For more information on the use of FFTs, please refer to Keysight Application Note 243, *The Fundamentals of Signal Analysis* at <http://literature.cdn.keysight.com/litweb/pdf/5952-8898E.pdf>. Additional information can be obtained from Chapter 4 of the book *Spectrum and Network Measurements* by Robert A. Witte.

## FFT Units

0 dBV is the amplitude of a 1 V<sub>rms</sub> sinusoid. When the FFT source is channel 1 or channel 2 (or channel 3 or 4 on 4-channel models), FFT units will be displayed in dBV when channel units is set to Volts and channel impedance is set to 1 M $\Omega$ .

FFT units will be displayed in dBm when channel units is set to Volts and channel impedance is set to 50 $\Omega$ .

FFT units will be displayed as dB for all other FFT sources or when a source channel's units has been set to Amps.

## FFT DC Value

The FFT computation produces a DC value that is incorrect. It does not take the offset at center screen into account. The DC value is not corrected in order to accurately represent frequency components near DC.

## FFT Aliasing

When using FFTs, it is important to be aware of frequency aliasing. This requires that the operator have some knowledge as to what the frequency domain should contain, and also consider the sampling rate, frequency span, and oscilloscope vertical bandwidth when making FFT measurements. The FFT resolution (the quotient of the sampling rate and the number of FFT points) is displayed on-screen when the FFT menu is open.

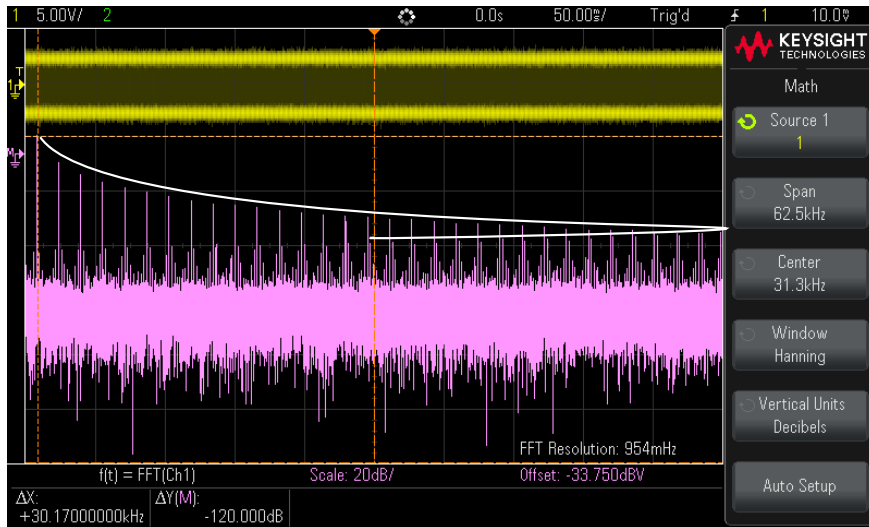
**NOTE****Nyquist Frequency and Aliasing in the Frequency Domain**

The Nyquist frequency is the highest frequency that any real-time digitizing oscilloscope can acquire without aliasing. This frequency is half of the sample rate. Frequencies above the Nyquist frequency will be under sampled, which causes aliasing. The Nyquist frequency is also called the folding frequency because aliased frequency components fold back from that frequency when viewing the frequency domain.

---

Aliasing happens when there are frequency components in the signal higher than half the sample rate. Because the FFT spectrum is limited by this frequency, any higher components are displayed at a lower (aliased) frequency.

The following figure illustrates aliasing. This is the spectrum of a 990 Hz square wave, which has many harmonics. The horizontal time/div setting for the square wave sets the sample rate and results in a FFT resolution of 1.91 Hz. The displayed FFT spectrum waveform shows the components of the input signal above the Nyquist frequency to be mirrored (aliased) on the display and reflected off the right edge.



**Figure 9** Aliasing

Because the frequency span goes from  $\approx 0$  to the Nyquist frequency, the best way to prevent aliasing is to make sure that the frequency span is greater than the frequencies of significant energy present in the input signal.

## FFT Spectral Leakage

The FFT operation assumes that the time record repeats. Unless there is an integral number of cycles of the sampled waveform in the record, a discontinuity is created at the end of the record. This is referred to as leakage. In order to minimize spectral leakage, windows that approach zero smoothly at the beginning and end of the signal are employed as filters to the FFT. The FFT menu provides four windows: Hanning, Flat Top, Rectangular, and Blackman-Harris. For more information on leakage, see Keysight Application Note 243, *The Fundamentals of Signal Analysis* at

<http://literature.cdn.keysight.com/litweb/pdf/5952-8898E.pdf>.





## 6 Math Waveforms

To display math waveforms / 66

To perform a math function on an arithmetic operation / 67

To adjust the math waveform scale and offset / 67

Units for Math Waveforms / 67

Math Operators / 68

Math Transforms / 70

Math Filters / 74

Math functions can be performed on analog channels. The resulting math waveform is displayed in light purple.

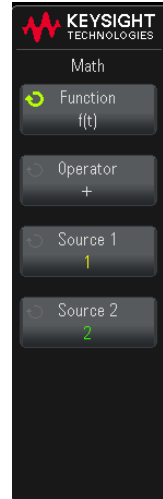
You can use a math function on a channel even if you choose not to display the channel on-screen.

You can:

- Perform an arithmetic operation (like add, subtract, or multiply) on analog input channels.
- Perform a transform function (like FFT) on an analog input channel.
- Perform a transform function on the result of an arithmetic operation.

## To display math waveforms

- 1 Press the **[Math]** key on the front panel to display the waveform Math menu.
- 2 If **f(t)** is not already shown on the **Function** softkey, press the **Function** softkey and select **f(t): Displayed**.
- 3 Use the **Operator** softkey to select an operator or transform.  
For more information on the operators, transforms, or filters, see:
  - **"Math Operators"** on page 68
  - **"Math Transforms"** on page 70
  - **"Math Filters"** on page 74
- 4 Use the **Source 1** softkey to select the analog channel on which to perform math. You can rotate the Entry knob or repetitively press the **Source 1** softkey to make your selection. If you choose a transform function (FFT) the result is displayed.
- 5 If you select an arithmetic operator, use the **Source 2** softkey to select the second source for the arithmetic operation. The result is displayed.
- 6 To re-size and re-position the math waveform, see **"To adjust the math waveform scale and offset"** on page 67.



### TIP

#### Math Operating Hints

If the analog channel or math function is clipped (not fully displayed on screen) the resulting displayed math function will also be clipped.

Once the function is displayed, the analog channel(s) may be turned off for better viewing of the math waveform.

The vertical scaling and offset of each math function can be adjusted for ease of viewing and measurement considerations.

The math function waveform can be measured using **[Cursors]** and/or **[Meas]**.

## To perform a math function on an arithmetic operation

To perform an FFT or low-pass filter math function on an arithmetic operation (add, subtract, or multiply):

- 1 Press the **Function** softkey and select **g(t): Internal**.
- 2 Use the **Operator**, **Source 1**, and **Source 2** softkeys to set up an arithmetic operation.
- 3 Press the **Function** softkey and select **f(t): Displayed**.
- 4 Use the **Operator** softkey to select an FFT or low-pass filter math function.
- 5 Press the **Source 1** softkey and select **g(t)** as the source. Note that **g(t)** is only available when you select an FFT or low-pass filter math function in the previous step.

## To adjust the math waveform scale and offset

Use the multiplexed scale and position knobs next to the **[Math]** key to re-size and re-position the math waveform.

### NOTE

#### Math Scale and Offset are Set Automatically

Any time the currently displayed math function definition is changed, the function is automatically scaled for optimum vertical scale and offset. If you manually set scale and offset for a function, select a new function, then select the original function, the original function will be automatically rescaled.

---

See Also · ["Units for Math Waveforms"](#) on page 67

## Units for Math Waveforms

Units for each input channel can be set to Volts or Amps using the **Units** softkey in the Channel Probe menu. Units for math function waveforms are:

Math function	Units
add or subtract	V or A
multiply	V <sup>2</sup> , A <sup>2</sup> , or W (Volt-Amp)
FFT Magnitude	dB (decibels) or V RMS.
FFT Phase	degrees or radians

A scale unit of **U** (undefined) will be displayed for math functions when two source channels are used and they are set to dissimilar units and the combination of units cannot be resolved.

## Math Operators

Math operators perform arithmetic operations (add, subtract, or multiply) on analog input channels.

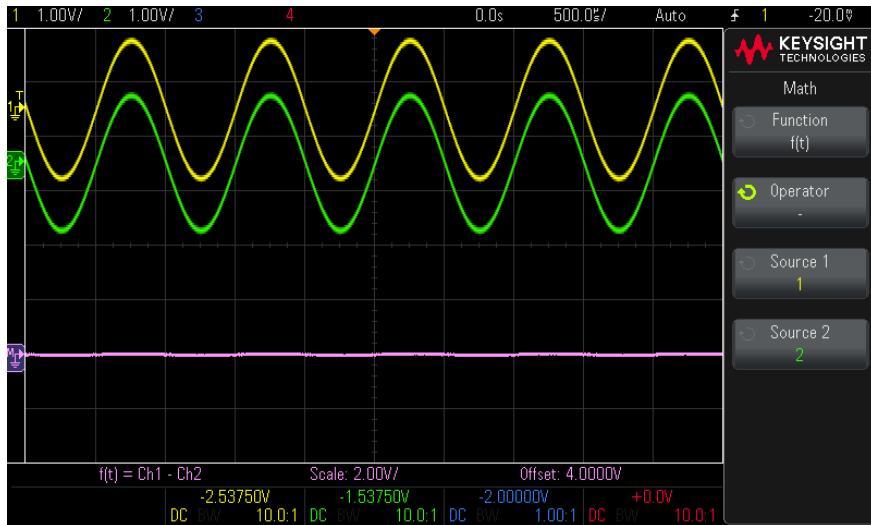
- **"Add or Subtract"** on page 68
- **"Multiply or Divide"** on page 69

### Add or Subtract

When you select add or subtract, the **Source 1** and **Source 2** values are added or subtracted point by point, and the result is displayed.

You can use subtract to make a differential measurement or to compare two waveforms.

If your waveforms' DC offsets are larger than the dynamic range of the oscilloscope's input channels you will need to use a differential probe instead.



**Figure 10** Example of Subtract Channel 2 from Channel 1

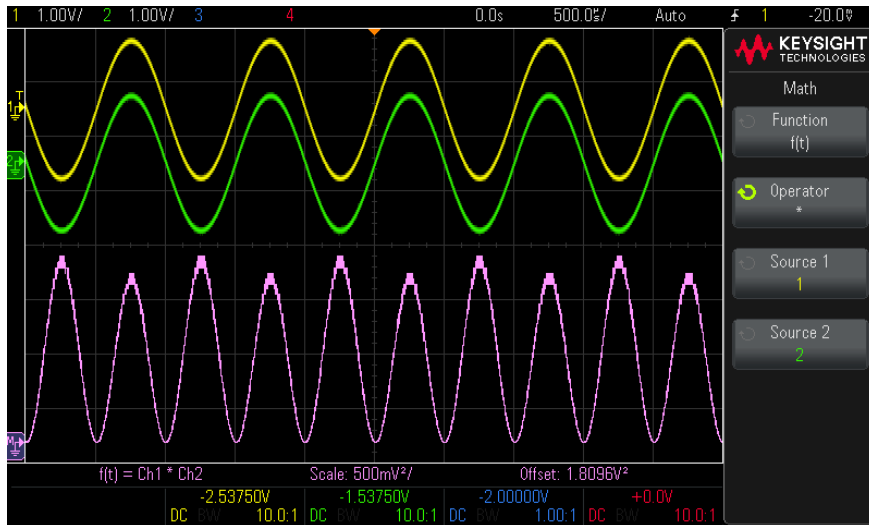
See Also · ["Units for Math Waveforms"](#) on page 67

## Multiply or Divide

When you select the multiply or divide math function, the **Source 1** and **Source 2** values are multiplied or divided point by point, and the result is displayed.

The divide by zero case places holes (that is, zero values) in the output waveform.

Multiply is useful for seeing power relationships when one of the channels is proportional to the current.



**Figure 11** Example of Multiply Channel 1 by Channel 2

See Also · ["Units for Math Waveforms"](#) on page 67

## Math Transforms

Math transforms perform a transform function (FFT) on an analog input channel or on the result of an arithmetic operation.

· ["FFT Magnitude, FFT Phase"](#) on page 70

### FFT Magnitude, FFT Phase

Using the Fast Fourier Transform (FFT), the FFT (Magnitude) math function displays the magnitudes of the frequency content that makes up the source waveform, and the FFT (Phase) math function shows the phase relationships of the frequency content. The FFT takes the digitized time record of the specified source and transforms it to the frequency domain.

The source of the FFT math functions can be analog input channels or an arithmetic operation  $g(t)$ .

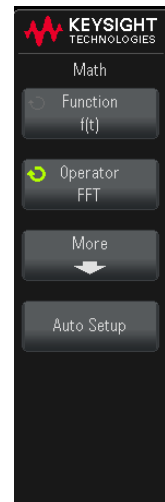
The horizontal axis of FFT math functions is frequency (Hertz). For the FFT (Magnitude) math function, the vertical axis is in decibels or V RMS. For the FFT (Phase) math function, the vertical axis is in degrees or radians.

Use the FFT (Magnitude) function to find crosstalk problems, to find distortion problems in analog waveforms caused by amplifier non-linearity, or for adjusting analog filters.

To display a FFT waveform:

**1** Press the **[Math]** key, press the **Function** softkey and select **f(t)**, press the **Operator** softkey and select **FFT (Magnitude)** or **FFT (Phase)**.

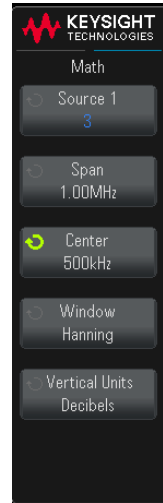
- **More** – displays the FFT settings menu.
- **Auto Setup** – sets the frequency Span and Center to values that will cause the entire available spectrum to be displayed. The maximum available frequency is half the FFT sample rate, which is a function of the time per division setting. The FFT resolution is the quotient of the sampling rate and the number of FFT points ( $f_s/N$ ). The current FFT Resolution is displayed.



2 Press the **More** softkey to display the FFT settings.

- **Source 1** – selects the source for the FFT. (See "**To perform a math function on an arithmetic operation**" on page 67 for information about using **g(t)** as the source.)
- **Span** – sets the overall width of the FFT spectrum that you see on the display (left to right). Divide span by 10 to calculate the number of Hertz per division. It is possible to set Span above the maximum available frequency, in which case the displayed spectrum will not take up the whole screen. Press the **Span** softkey, then turn the Entry knob to set the desired frequency span of the display.
- **Center** – sets the FFT spectrum frequency represented at the center vertical grid line of the display. It is possible to set the Center to values below half the span or above the maximum available frequency, in which case the displayed spectrum will not take up the whole screen. Press the **Center** softkey, then turn the Entry knob to set the desired center frequency of the display.
- **Window**– selects a window to apply to your FFT input signal:
  - **Hanning** – window for making accurate frequency measurements or for resolving two frequencies that are close together.
  - **Flat Top** – window for making accurate amplitude measurements of frequency peaks.
  - **Rectangular** – good frequency resolution and amplitude accuracy, but use only where there will be no leakage effects. Use on self-windowing waveforms such as pseudo-random noise, impulses, sine bursts, and decaying sinusoids.
  - **Blackman Harris** – window reduces time resolution compared to a rectangular window, but improves the capacity to detect smaller impulses due to lower secondary lobes.
- **Vertical Units** – For FFT (Magnitude), you can select **Decibels** or **V RMS**. For FFT (Phase), you can select **Degrees** or **Radians**.

Use the knobs for the **[Math]** key to adjust the FFT waveform vertical scale and offset.





**NOTE****Scale and offset considerations**

If you do not manually change the FFT scale or offset settings, when you turn the horizontal scale knob, the span and center frequency settings will automatically change to allow optimum viewing of the full spectrum.

If you do manually set scale or offset, turning the horizontal scale knob will not change the span or center frequency settings, allowing you see better detail around a specific frequency.

Pressing the FFT **Auto Setup** softkey will automatically rescale the waveform and span and center will again automatically track the horizontal scale setting.

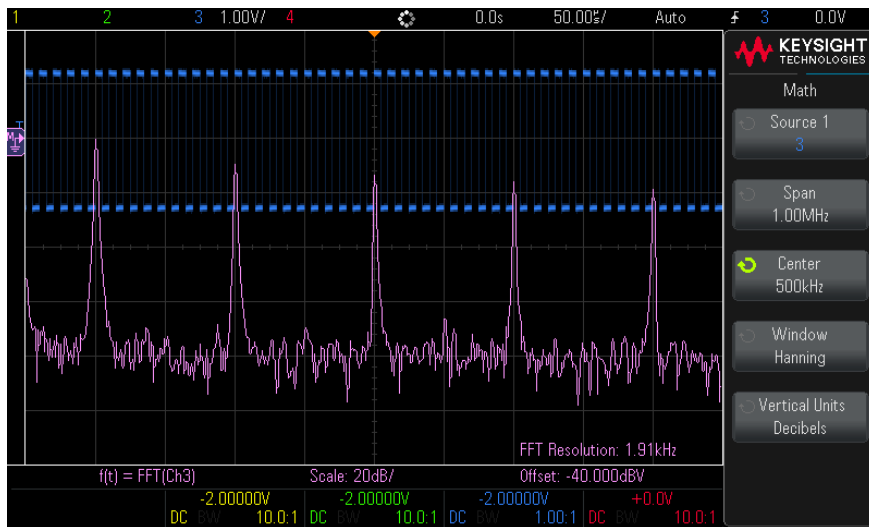
- 3** To make cursor measurements, press the **[Cursors]** key and set the **Source** softkey to **Math: f(t)**.

Use the X1 and X2 cursors to measure frequency values and difference between two frequency values ( $\Delta X$ ). Use the Y1 and Y2 cursors to measure amplitude in dB and difference in amplitude ( $\Delta Y$ ).

- 4** To make other measurements, press the **[Meas]** key and set the **Source** softkey to **Math: f(t)**.

You can make peak-to-peak, maximum, minimum, and average dB measurements on the FFT waveform. You can also find the frequency value at the first occurrence of the waveform maximum by using the X at Max Y measurement.

The following FFT spectrum was obtained by connecting a 4 V, 75 kHz square wave to channel 1. Set the horizontal scale to 50  $\mu\text{s}/\text{div}$ , vertical sensitivity to 1 V/div, Units/div to 20 dBV, Offset to -60.0 dBV, Center frequency to 250 kHz, frequency Span to 500 kHz, and window to Hanning.



- See Also
- ["To perform a math function on an arithmetic operation"](#) on page 67
  - ["FFT Measurement Hints"](#) on page 60
  - ["FFT Units"](#) on page 61
  - ["FFT DC Value"](#) on page 61
  - ["FFT Aliasing"](#) on page 62
  - ["FFT Spectral Leakage"](#) on page 63
  - ["Units for Math Waveforms"](#) on page 67

## Math Filters

You can use math filters to create a waveform that is the result of a low-pass filter on an analog input channel or on the result of an arithmetic operation.

- ["Low Pass Filter"](#) on page 74

### Low Pass Filter

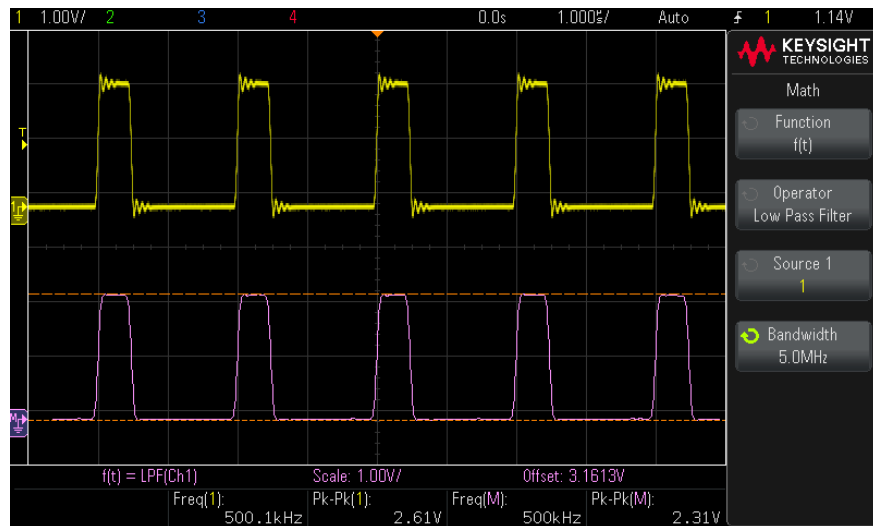
The low-pass filter function applies the filter to the selected source waveform and displays the result in the math waveform.

The low-pass filter is a 4th order Bessel-Thompson filter.

Use the **Bandwidth** softkey to select the filter's -3 dB cutoff frequency.

### NOTE

The ratio of the input signal's Nyquist frequency and the selected -3 dB cutoff frequency affects how many points are available in the output, and under some circumstances, there are no points in the output waveform.



**Figure 12** Example of Low Pass Filter



## 7 Reference Waveforms

To save a waveform to a reference waveform location / 77

To display a reference waveform / 78

To scale and position reference waveforms / 79

To adjust reference waveform skew / 79

To display reference waveform information / 80

To save/recall reference waveform files to/from a USB storage device / 80

Analog channel or math waveforms can be saved to one of two reference waveform locations in the oscilloscope. Then, a reference waveform can be displayed and compared against other waveforms. One reference waveform can be displayed at a time.

You can adjust the vertical scale and offset of reference waveforms. There is also a skew adjustment for reference waveforms. Reference waveform scale, offset, and skew information can optionally be included on the oscilloscope display.

Analog channel, math, or reference waveforms can be saved to a reference waveform file on a USB storage device. You can recall a reference waveform file from a USB storage device into one of the reference waveform locations.

### To save a waveform to a reference waveform location

- 1 Press the **[Analyze]** key.
- 2 Press **Features**; then, select **R1** or **R2**.
- 3 Press **Features** again (or push the Entry knob) to turn on the reference waveform.
- 4 Press **Save/Clear**.

- 5 In the Save/Clear menu, press the **Source** softkey and turn the Entry knob to select the source waveform.
- 6 Press the **Save to R1/R2** softkey to save the waveform to the reference waveform location.

**NOTE**

Reference waveforms are non-volatile – they remain after power cycling or performing a default setup.

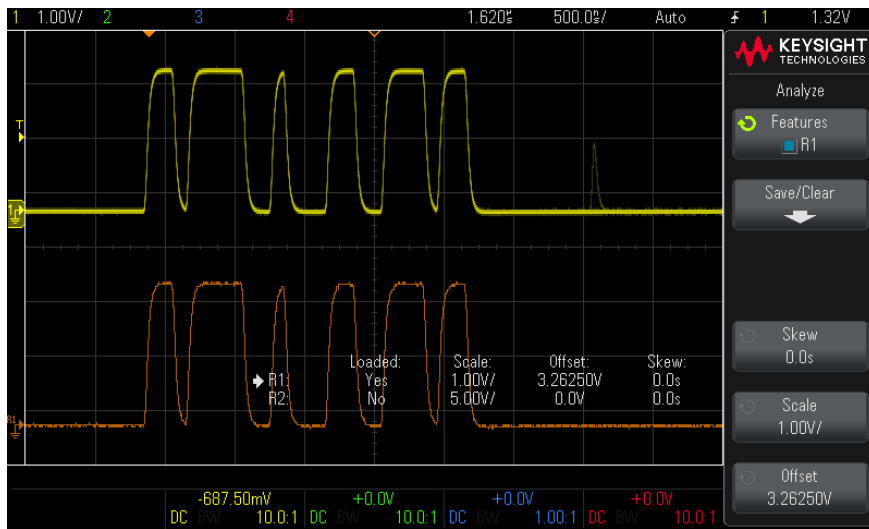
To clear a  
reference  
waveform location

- 1 Press the **[Analyze]** key.
- 2 Press **Features**; then, select **R1** or **R2**.
- 3 Press **Features** again (or push the Entry knob) to turn on the reference waveform.
- 4 Press **Save/Clear**.
- 5 In the Save/Clear menu, press the **Clear R1/R2** softkey to clear the reference waveform location.

Reference waveforms are also cleared by a Factory Default or Secure Erase (see [Chapter 20](#), “Save/Recall (Setups, Screens, Data),” starting on page 217).

## To display a reference waveform

- 1 Press the **[Analyze]** key.
- 2 Press **Features**; then, select **R1** or **R2**.
- 3 Press **Features** again (or push the Entry knob) to turn on the reference waveform.



One reference waveform can be displayed at a time.

See Also • ["To display reference waveform information"](#) on page 80

## To scale and position reference waveforms

- 1 Display the desired reference waveform (see ["To display a reference waveform"](#) on page 78).
- 2 Press the **Scale** softkey and turn the Entry knob to adjust the reference waveform vertical scale.
- 3 Press the **Offset** softkey and turn the Entry knob to adjust the reference waveform vertical offset.

## To adjust reference waveform skew

Once reference waveforms are displayed, you can adjust their skew.

- 1 Display the desired reference waveform (see ["To display a reference waveform"](#) on page 78).

- 2 Press the **Skew** softkey and turn the Entry knob to adjust the reference waveform skew.

## To display reference waveform information

- 1 Press the **[Analyze]** key.
- 2 Press **Features**; then, select **R1** or **R2**.
- 3 Press **Save/Clear**.
- 4 In the Save/Clear menu, press the **Display Info** softkey to enable or disable reference waveform information on the oscilloscope display.
- 5 Press the **Transparent** softkey to enable or disable transparent information backgrounds.

This setting is also used for other oscilloscope information on the display, like mask test statistics, etc.

## To save/recall reference waveform files to/from a USB storage device

Analog channel, math, or reference waveforms can be saved to a reference waveform file on a USB storage device. See "[To save reference waveform files to a USB storage device](#)" on page 222.

You can recall a reference waveform file from a USB storage device into one of the reference waveform locations. See "[To recall reference waveform files from a USB storage device](#)" on page 226.



## 8 Serial Bus Decode/Trigger

Depending on the oscilloscope model, the following hardware-accelerated serial decode and trigger features are available:

Serial decode and trigger type:	Available on:
CAN (Controller Area Network)	DSOX1200-Series models
I2C (Inter-IC)	DSOX1200-Series and EDUX1052A/G models
LIN (Local Interconnect Network)	DSOX1200-Series models
SPI (Serial Peripheral Interface)	DSOX1200-Series models
UART (Universal Asynchronous Receiver/Transmitter) protocols including RS232 (Recommended Standard 232)	DSOX1200-Series and EDUX1052A/G models

### Triggering on Serial Data

In some cases, such as when triggering on a slow serial signal (for example, I2C, SPI, CAN, LIN, etc.), to stabilize the waveform display, it may be necessary to switch from the Auto trigger mode to the Normal trigger mode to prevent the oscilloscope from auto-triggering. You can select the trigger mode by pressing the **[Trigger]** key, then the **Mode** softkey.

Also, the threshold voltage level must be set appropriately for each source channel. The threshold level for each serial signal can be set in the Signals menu (press **[Analyze]** > **Features**, select **Serial Bus**, then press the **Signals** softkey).

- See Also
- **Chapter 25**, “CAN Triggering and Serial Decode,” starting on page 277
  - **Chapter 26**, “I2C Triggering and Serial Decode,” starting on page 287
  - **Chapter 27**, “LIN Triggering and Serial Decode,” starting on page 295

- **Chapter 28**, “SPI Triggering and Serial Decode,” starting on page 303
- **Chapter 29**, “UART/RS232 Triggering and Serial Decode,” starting on page 315

## 9 Display Settings

To adjust waveform intensity / 83

To set or clear persistence / 85

To clear the display / 86

To select the grid type / 86

To adjust the grid intensity / 87

To add an annotation / 87

To freeze the display / 89

### To adjust waveform intensity

You can adjust the intensity of displayed waveforms to account for various signal characteristics, such as fast time/div settings and low trigger rates.

Increasing the intensity lets you see the maximum amount of noise and infrequently occurring events.

Reducing the intensity can expose more detail in complex signals as shown in the following figures.

- 1 Press the **[Intensity]** key to illuminate it.

This key is located just below the Entry knob.

- 2 Turn the Entry knob to adjust the waveform intensity.

Waveform intensity adjustment affects analog channel waveforms only (not math waveforms, reference waveforms, etc.).

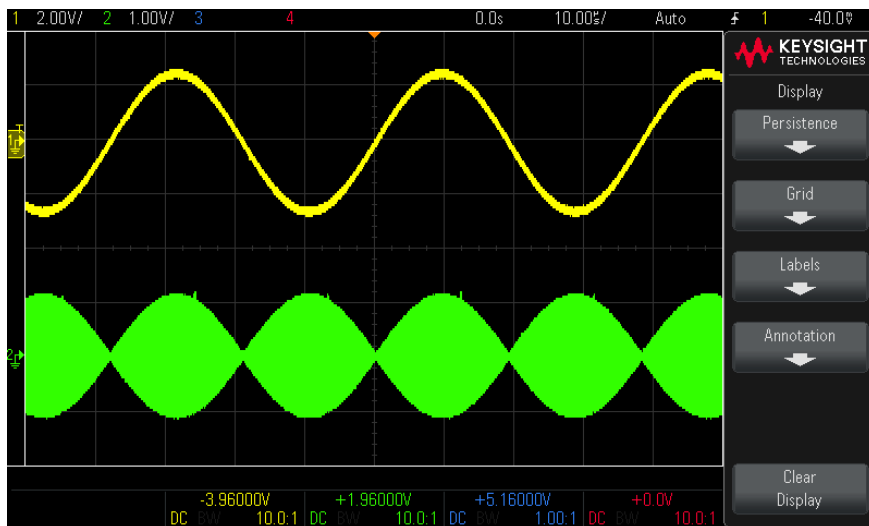


Figure 13 Amplitude Modulation Shown at 100% Intensity

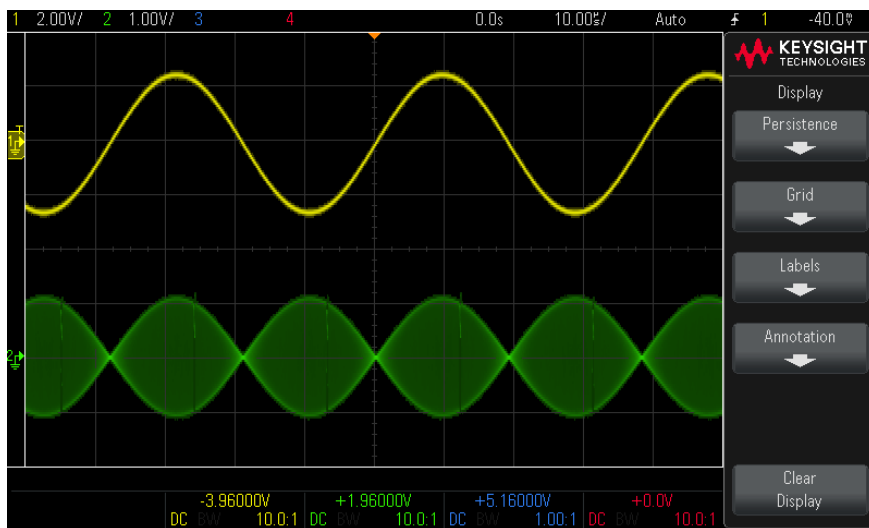


Figure 14 Amplitude Modulation Shown at 40% Intensity

## To set or clear persistence

With persistence, the oscilloscope updates the display with new acquisitions, but does not immediately erase the results of previous acquisitions. All previous acquisitions are displayed with reduced intensity. New acquisitions are shown in their normal color with normal intensity.

Waveform persistence is kept only for the current display area; you cannot pan and zoom the persistence display.

To use persistence:

- 1 Press the **[Display]** key.
- 2 In the Display menu, press **Persistence**.
- 3 In the Persistence menu, press **Persistence**; then, turn the Entry knob to select between:

- **Off** – turns off persistence.

When persistence is off, you can press the **Capture Waveforms** softkey to perform a single-shot infinite persistence. A single acquisition's data is displayed with reduced intensity, and it remains on the display until you clear persistence or clear the display.

- **∞ Persistence** – (infinite persistence) Results of previous acquisitions are never erased.

Use infinite persistence to measure noise and jitter, to see the worst-case extremes of varying waveforms, to look for timing violations, or to capture events that occur infrequently.

- **Variable Persistence** – Results of previous acquisitions are erased after a certain amount of time.

Variable persistence gives you a view of acquired data that is similar to analog oscilloscopes.

When variable persistence is selected, press the **Time** softkey and use the Entry knob to specify the amount of time that previous acquisitions are to be displayed.

The display will begin accumulating multiple acquisitions.

- 4 To erase the results of previous acquisitions from the display, press the **Clear Persistence** softkey.

The oscilloscope will start to accumulate acquisitions again.

- 5 To return the oscilloscope to the normal display mode, turn off persistence; then, press the **Clear Persistence** softkey.

Turning off persistence does not clear the display. The display is cleared if you press the **Clear Display** softkey or if you press the **[Auto Scale]** key (which also turns off persistence).

For another method of seeing worst-case extremes of varying waveforms, see "**Glitch or Narrow Pulse Capture**" on page 136.

## To clear the display

- 1 Press **[Display] > Clear Display**.

You can also configure the **[Quick Action]** key to clear the display. See "**Configuring the [Quick Action] Key**" on page 248.

## To select the grid type


When the **Video** trigger type is selected (see "**Video Trigger**" on page 108), and the vertical scaling of at least one displayed channel is 140 mV/div, the **Grid** softkey lets you select from these grid types:

- **Full** – the normal oscilloscope grid.
- **mV** – shows vertical grids, labeled on the left, from -0.3 V to 0.8 V.
- **IRE** – (Institute of Radio Engineers) shows vertical grids in IRE units, labeled on the left, from -40 to 100 IRE. The 0.35 V and 0.7 V levels from the **mV** grid are also shown and labeled at the right. When the **IRE** grid is selected, cursor values are also shown in IRE units. (Cursor values via the remote interface are not in IRE units.)

The **mV** and **IRE** grid values are accurate (and match Y cursor values) when the vertical scaling is 140 mV/division and the vertical offset is 245 mV.


To select the grid type:

- 1 Press **[Display]**.
- 2 In the Display menu, press **Grid**.

- 3 In the Grid menu, press the **Grid** softkey; then, turn the Entry knob  to select the grid type.

## To adjust the grid intensity

To adjust the display grid (graticule) intensity:

- 1 Press **[Display]**.
- 2 In the Display menu, press **Grid**.
- 3 In the Grid menu, press the **Intensity** softkey; then, turn the Entry knob  to change the intensity of the displayed grid.

The intensity level is shown in the **Intensity** softkey and is adjustable from 0 to 100%.

Each major vertical division in the grid corresponds to the vertical sensitivity shown in the status line at the top of the display.

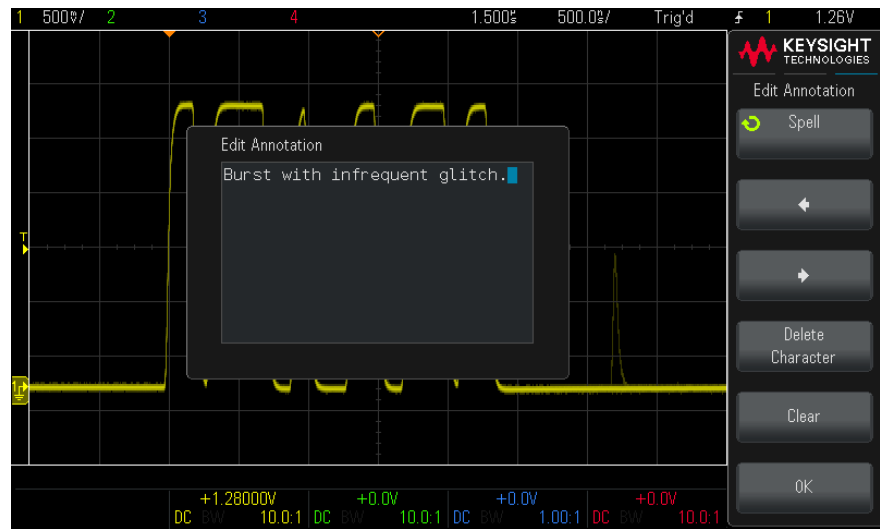
Each major horizontal division in the grid corresponds to the time/div shown in the status line at the top of the display.

## To add an annotation

You can add an annotation to the upper left corner of the oscilloscope's display. The annotation is useful for documentation purposes, to add notes before capturing screens.

To add an annotation:

- 1 On the oscilloscope's front panel, press **[Display]**.
- 2 In the Display menu, press **Annotation**.
- 3 In the Annotation menu, press **Annotation** to enable the annotation.
- 4 Press **Edit**.
- 5 In the Edit Annotation menu:




- Use the **Spell**, **◀**, **▶**, and **Delete Character** softkeys to enter the annotation text:
  - **Spell** – press this softkey and turn the Entry knob to select the character at the current position.
  - **◀** – press this softkey to enter characters and move the cursor to the next character position.
  - **▶** – press this softkey to enter characters and move the cursor to the previous character position.
  - **Delete Character** – press the **◀** or **▶** softkeys until the desired character is highlighted; then, press this softkey to delete the character.

**NOTE**

You can use a connected USB keyboard instead of using the **Spell** (and other) character editing softkeys.

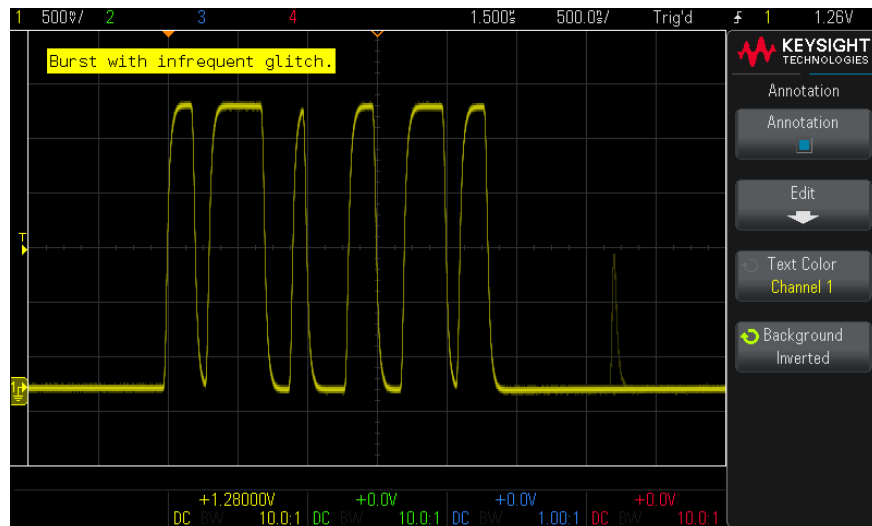
- Use the **Clear** softkey to delete all annotation characters.
- Press **OK** to save the annotation edits.



- 6 Press the  Back key to return the the Annotation menu.
- 7 Press the **Text Color** softkey and turn the Entry knob to select the annotation color.

You can choose white, red, or colors that match analog channels, digital channels, math waveforms, reference waveforms, or markers.

- 8 Press the **Background** softkey and turn the Entry knob to select the annotation background:
  - **Opaque** – the annotation has a solid background.
  - **Inverted** – the annotation's foreground and background colors are switched.
  - **Transparent** – the annotation has a transparent background.



- See Also
- ["To save BMP or PNG image files"](#) on page 219
  - ["To print the oscilloscope's display"](#) on page 229

## To freeze the display

To freeze the display without stopping running acquisitions, you must configure the **[Quick Action]** key. See ["Configuring the \[Quick Action\] Key"](#) on page 248.

- 1 Once the **[Quick Action]** key has been configured, press it to freeze the display.
- 2 To un-freeze the display, press **[Quick Action]** again.

Manual cursors can be used on the frozen display.

Many activities, such as adjusting the trigger level, adjusting vertical or horizontal settings, or saving data will un-freeze the display.

# 10 Labels

- To turn the label display on or off / 91
- To assign a predefined label to a channel / 92
- To define a new label / 93
- To load a list of labels from a text file you create / 94
- To reset the label library to the factory default / 95

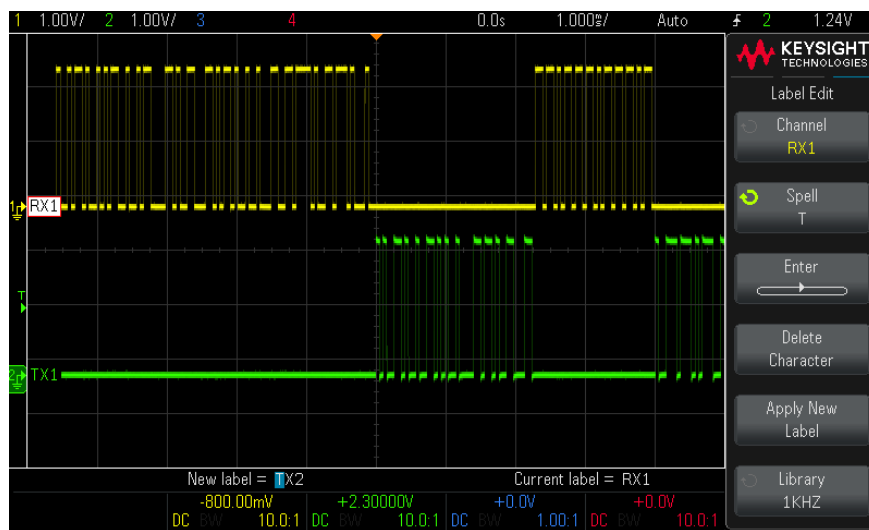
You can define labels and assign them to each analog input channel, or you can turn labels off to increase the waveform display area.

## To turn the label display on or off

- 1 Press **[Display] > Labels > Display**.

This turns on labels for the displayed analog channels. Labels are displayed at the left edge of the displayed traces.

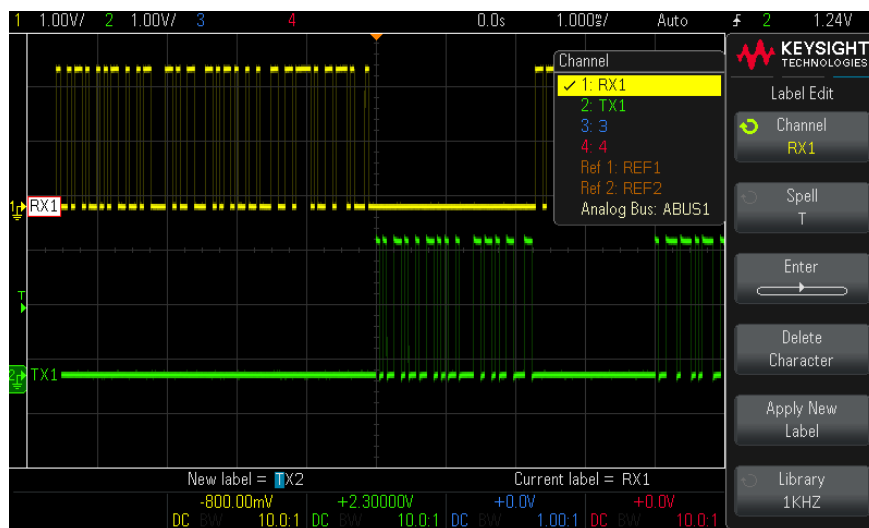
The figure below shows an example of displayed labels.



- 2 To turn the labels off, press the **Display** softkey again.

To assign a predefined label to a channel

- 1 Press **[Display] > Labels > Edit**.
- 2 Press the **Channel** softkey, then turn the Entry knob or successively press the **Channel** softkey to select a channel for label assignment.



The figure above shows the list of channels and their default labels. The channel does not have to be turned on to have a label assigned to it.

- 3 Press the **Library** softkey, then turn the Entry knob or successively press the **Library** softkey to select a predefined label from the library.
- 4 Press the **Apply New Label** softkey to assign the label to your selected channel.
- 5 Repeat the above procedure for each predefined label you want to assign to a channel.

## To define a new label

- 1 Press **[Display] > Labels > Edit**.
- 2 Press the **Channel** softkey; then, turn the Entry knob or successively press the softkey to select a channel for label assignment.

The channel does not have to be turned on to have a label assigned to it. If the channel is turned on, its current label will be highlighted.

- 3 Press the **Spell** softkey; then, turn the Entry knob to select the first character in the new label.

Turning the Entry knob selects a character to enter into the highlighted position shown in the "New label =" line and in the **Spell** softkey. Labels can be up to ten characters in length.

- 4 Press the **Enter** softkey to enter the selected character and to go to the next character position.
- 5 You may position the highlight on any character in the label name by successively pressing the **Enter** softkey.
- 6 To delete a character from the label, press the **Enter** softkey until the letter you want to delete is highlighted, then press the **Delete Character** softkey.

#### NOTE

You can use a connected USB keyboard instead of using the **Spell** (and other) character editing softkeys.

- 7 When you are done entering characters for the label, press the **Apply New Label** softkey to assign the label to the selected channel.

When you define a new label, it is added to the nonvolatile label list.

#### Label Assignment Auto-Increment

When you assign a label ending in a digit, such as ADDR0 or DATA0, the oscilloscope automatically increments the digit and displays the modified label in the "New label" field after you press the **Apply New Label** softkey. Therefore, you only need to select a new channel and press the **Apply New Label** softkey again to assign the label to the channel. Only the original label is saved in the label list. This feature makes it easier to assign successive labels to numbered control lines and data bus lines.

## To load a list of labels from a text file you create

It may be convenient to create a list of labels using a text editor, then load the label list into the oscilloscope. This lets you type on a keyboard rather than edit the label list using the oscilloscope's controls.

You can create a list of up to 75 labels and load it into the oscilloscope. Labels are added to the beginning of the list. If more than 75 labels are loaded, only the first 75 are stored.

To load labels from a text file into the oscilloscope:

- 1 Use a text editor to create each label. Each label can be up to ten characters in length. Separate each label with a line feed.
- 2 Name the file `labellist.txt` and save it on a USB mass storage device such as a thumb drive.
- 3 Load the list into the oscilloscope using the File Explorer (press **[Utility]** > **File Explorer**).

**NOTE****Label List Management**

When you press the **Library** softkey, you will see a list of the last 75 labels used. The list does not save duplicate labels. Labels can end in any number of trailing digits. As long as the base string is the same as an existing label in the library, the new label will not be put in the library. For example, if label `A0` is in the library and you make a new label called `A12345`, the new label is not added to the library.

When you save a new user-defined label, the new label will replace the oldest label in the list. Oldest is defined as the longest time since the label was last assigned to a channel. Any time you assign any label to a channel, that label will move to the newest in the list. Thus, after you use the label list for a while, your labels will predominate, making it easier to customize the instrument display for your needs.

When you reset the label library list (see next topic), all of your custom labels will be deleted, and the label list will be returned to its factory configuration.

---

## To reset the label library to the factory default

**NOTE**

Pressing the **Default Library** softkey will remove all user-defined labels from the library and set the labels back to the factory default. Once deleted, these user-defined labels cannot be recovered.

- 1 Press **[Utility]** > **Options** > **Preferences**.
- 2 Press the **Default Library** softkey.

This will delete all user-defined labels from the library and set the labels in the library back to the factory default. However, this does not default the labels currently assigned to the channels (those labels that appear in the waveform area).

**NOTE**

**Defaulting labels without erasing the default library**

Pressing [**Default Setup**] sets all channel labels back to the default labels but does not erase the list of user-defined labels in the library.

---



# 11 Triggers

- Adjusting the Trigger Level / 99
- Forcing a Trigger / 99
- Edge Trigger / 99
- Pulse Width Trigger / 102
- Pattern Trigger / 104
- Rise/Fall Time Trigger / 106
- Setup and Hold Trigger / 107
- Video Trigger / 108
- Serial Trigger / 118

A trigger setup tells the oscilloscope when to acquire and display data. For example, you can set up to trigger on the rising edge of the analog channel 1 input signal.

You can adjust the vertical level used for analog channel edge detection by turning the Trigger Level knob.



In addition to the edge trigger type, you can also set up triggers on pulse widths or video signals. On DSOX1200-Series models, you can additionally set up triggers on patterns, rise/fall times, or setup and hold violations.

You can use any input channel or the EXT TRIG input BNC (see **"External Trigger Input"** on page 127) as the source for most trigger types.

Changes to the trigger setup are applied immediately. If the oscilloscope is stopped when you change a trigger setup, the oscilloscope uses the new specification when you press **[Run/Stop]** or **[Single]**. If the oscilloscope is running when you change a trigger setup, it uses the new trigger definition when it starts the next acquisition.

You can use the **[Force]** key to acquire and display data when triggers are not occurring.

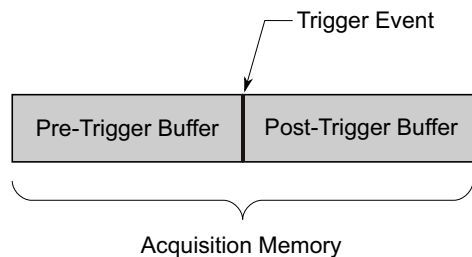
You can use the **[Trigger]** key to set options that affect all trigger types (see **Chapter 12**, "Trigger Mode/Coupling," starting on page 121).

You can save trigger setups along with the oscilloscope setup (see **Chapter 20**, "Save/Recall (Setups, Screens, Data)," starting on page 217).

#### Triggers - General Information

A triggered waveform is one in which the oscilloscope begins tracing (displaying) the waveform, from the left side of the display to the right, each time a particular trigger condition is met. This provides stable display of periodic signals such as sine waves and square waves, as well as nonperiodic signals such as serial data streams.

The figure below shows the conceptual representation of acquisition memory. You can think of the trigger event as dividing acquisition memory into a pre-trigger and post-trigger buffer. The position of the trigger event in acquisition memory is defined by the time reference point and the delay (horizontal position) setting (see **"To adjust the horizontal delay (position)"** on page 39).



## Adjusting the Trigger Level

You can adjust the trigger level for a selected analog channel by turning the Trigger Level knob.

You can push the Trigger Level knob to set the level to the waveform's 50% value. If AC coupling is used, pushing the Trigger Level knob sets the trigger level to about 0 V.

The position of the trigger level for the analog channel is indicated by the trigger level icon **T▶** (if the analog channel is on) at the far left side of the display. The value of the analog channel trigger level is displayed in the upper-right corner of the display.

The line trigger level is not adjustable. This trigger is synchronized with the power line supplied to the oscilloscope.

### NOTE

You can also change the trigger level of all channels by pressing **[Analyze] > Features** and then selecting **Trigger Levels**.

## Forcing a Trigger

The **[Force]** key causes a trigger (on anything) and displays the acquisition.

This key is useful in the Normal trigger mode where acquisitions are made only when the trigger condition is met. In this mode, if no triggers are occurring (that is, the "Trig'd?" indicator is displayed), you can press **[Force]** to force a trigger and see what the input signals look like.

In the Auto trigger mode, when the trigger condition is not met, triggers are forced and the "Auto?" indicator is displayed.

## Edge Trigger

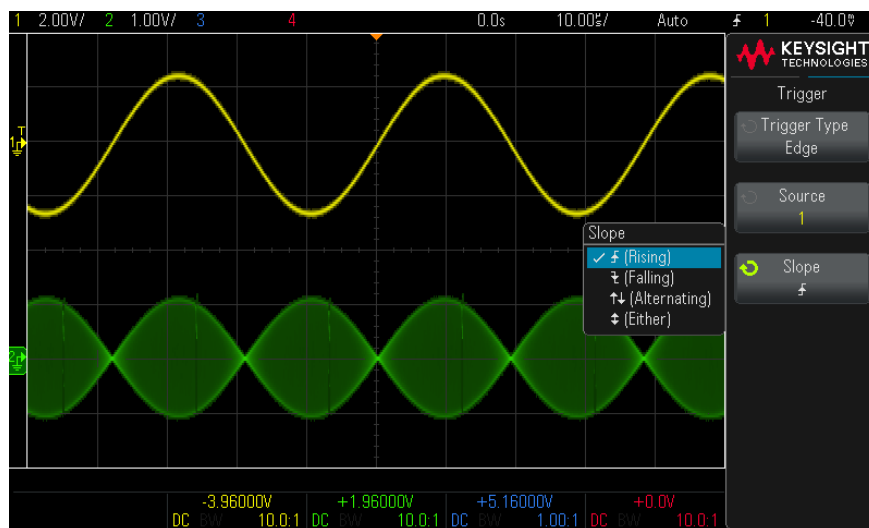
The Edge trigger type identifies a trigger by looking for a specified edge (slope) and voltage level on a waveform. You can define the trigger source and slope in this menu. The trigger type, source, and level (if applicable) are displayed in the upper-right corner of the display.

- 1 On the front panel, in the Trigger section, press the **[Trigger]** key.
- 2 In the Trigger menu, press the **Trigger Type** softkey.
- 3 Press the **Trigger Type** softkey; then, turn the Entry knob to select **Edge**.
- 4 Select the trigger source:
  - Analog channel, **1** to the number of channels
  - **External** – triggers on the rear panel EXT TRIG input signal.
  - **Line** – triggers at the 50% level of the rising or falling edge of the AC power source signal.
  - **WaveGen** – triggers at the 50% level of the rising edge of the waveform generator output signal. (Not available when the DC or Noise waveforms are selected.)
  - **WaveGen Mod (FSK/FM)** – when waveform generator FSK or FM modulation is used, triggers at the 50% level of the rising edge of the modulating signal.

You can choose a channel that is turned off (not displayed) as the source for the edge trigger.

The selected trigger source is indicated in the upper-right corner of the display next to the slope symbol:

- **1** through **4** = analog channels.
  - **E** = External trigger input.
  - **L** = Line trigger.
  - **W** = Waveform generator.
- 5 Press the **Slope** softkey and select rising edge, falling edge, alternating edges, or either edge (depending on the selected source). The selected slope is displayed in the upper-right corner of the display.

**NOTE**

Alternating edge mode is useful when you want to trigger on both edges of a clock (for example, DDR signals).

Either edge mode is useful when you want to trigger on any activity of a selected source.

All modes operate up to the bandwidth of the oscilloscope except Either edge mode, which has a limitation. Either edge mode will trigger on Constant Wave signals up to 100 MHz, but can trigger on isolated pulses down to  $1/(2 \times \text{oscilloscope's bandwidth})$ .

**Using Autoscale to  
Set Up Edge  
Triggers**

The easiest way to set up an Edge trigger on a waveform is to use Autoscale. Simply press the **[Auto Scale]** key and the oscilloscope will attempt to trigger on the waveform using a simple Edge trigger type. See "**Use Autoscale**" on page 24.

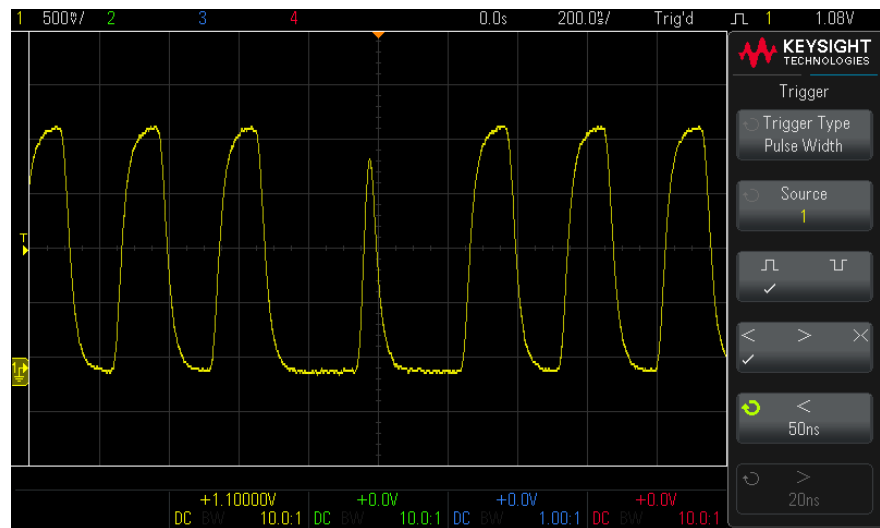
**NOTE**
**MegaZoom Technology Simplifies Triggering**

With the built-in MegaZoom technology, you can simply Autoscale the waveforms, then stop the oscilloscope to capture a waveform. You can then pan and zoom through the data using the Horizontal and Vertical knobs to find a stable trigger point. Autoscale often produces a triggered display.

## Pulse Width Trigger

Pulse Width (glitch) triggering sets the oscilloscope to trigger on a positive or negative pulse of a specified width. If you want to trigger on a specific timeout value, use **Pattern** trigger in the Trigger menu (see "**Pattern Trigger**" on page 104).

- 1 Press the **[Trigger]** key.
- 2 In the Trigger menu, press the **Trigger Type** softkey.
- 3 Press the **Trigger Type** softkey; then, turn the Entry knob to select **Pulse Width**.



- 4 Press the **Source** softkey; then, rotate the Entry knob to select a channel source for the trigger.

The channel you select is shown in the upper-right corner of the display next to the polarity symbol.

The source can be any analog channel available on your oscilloscope.

- 5 Adjust the trigger level by turning the Trigger Level knob.

The value of the trigger level is displayed in the upper-right corner of the display.

- 6** Press the pulse polarity softkey to select positive ( $\sqcap$ ) or negative ( $\sqcup$ ) polarity for the pulse width you want to capture.

The selected pulse polarity is displayed in the upper-right corner of the display. A positive pulse is higher than the current trigger level or threshold and a negative pulse is lower than the current trigger level or threshold.

When triggering on a positive pulse, the trigger will occur on the high to low transition of the pulse if the qualifying condition is true. When triggering on a negative pulse, the trigger will occur on the low to high transition of the pulse if the qualifying condition is true.

- 7** Press the qualifier softkey (< > ><) to select the time qualifier.

The Qualifier softkey can set the oscilloscope to trigger on a pulse width that is:

- Less than a time value (<).

For example, for a positive pulse, if you set  $t < 20$  ns:



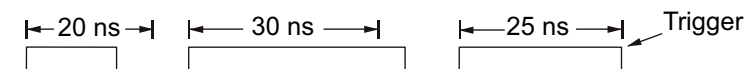
- Greater than a time value (>).

For example, for a positive pulse, if you set  $t > 20$  ns:



- Within a range of time values (><).

For example, for a positive pulse, if you set  $t > 20$  ns and  $t < 30$  ns:



- 8** Select the qualifier time set softkey (< or >), then rotate the Entry knob to set the pulse width qualifier time.

The qualifiers can be set as follows:

- 17 ns to 10 s for > or < qualifier.

## 11 Triggers

- 20 ns to 10 s for >< qualifier, with minimum difference of 5 ns between upper and lower settings.

Pulse width  
trigger < qualifier  
time set softkey

- When the less than (<) qualifier is selected, the Entry knob sets the oscilloscope to trigger on a pulse width less than the time value displayed on the softkey.
- When the time range (><) qualifier is selected, the Entry knob sets the upper time range value.

Pulse width  
trigger > qualifier  
time set softkey

- When the greater than (>) qualifier is selected, the Entry knob sets the oscilloscope to trigger on a pulse width greater than the time value displayed on the softkey.
- When the time range (><) qualifier is selected, the Entry knob sets the lower time range value.

## Pattern Trigger

On DSOX1200-Series oscilloscopes, the Pattern trigger identifies a trigger condition by looking for a specified pattern. This pattern is a logical AND combination of the channels. Each channel can have a value of 0 (low), 1 (high), or don't care (X). A rising or falling edge can be specified for one channel included in the pattern.

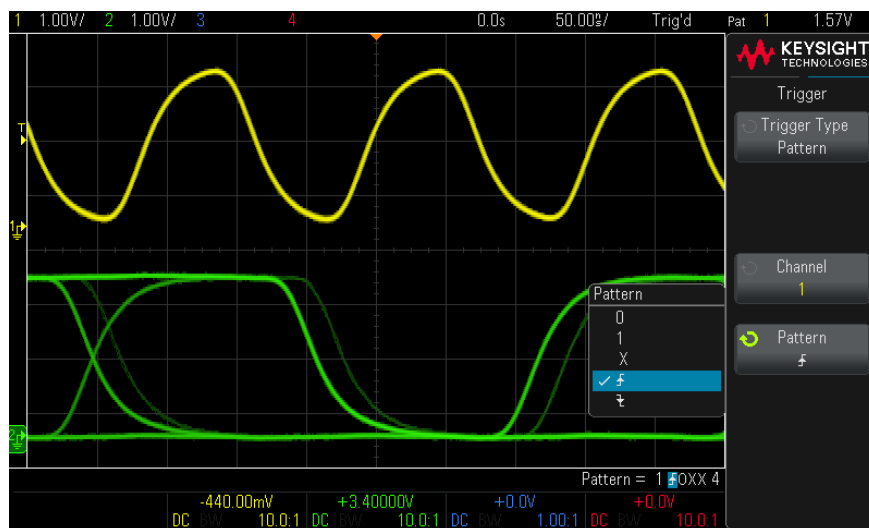
- 1 Press the **[Trigger]** key.
- 2 In the Trigger menu, press the **Trigger Type** softkey.
- 3 Press the **Trigger Type** softkey; then, turn the Entry knob to select **Pattern**.
- 4 For each analog channel you want to include in the desired pattern, press the **Channel** softkey to select the channel.



This is the channel source for the 0, 1, X, or edge condition. As you press the **Channel** softkey (or rotate the Entry knob), the channel you select is highlighted in the "Pattern =" line and in the upper-right corner of the display next to "Pat".

Adjust the trigger level for the selected analog channel by turning the Trigger Level knob. The value of the trigger level is displayed in the upper-right corner of the display.

- 5 For each channel you select, press the **Pattern** softkey; then, turn the Entry knob to set the condition for that channel in the pattern.





- **0** sets the pattern to zero (low) on the selected channel. A low is a voltage level that is less than the channel's trigger level or threshold level.
- **1** sets the pattern to 1 (high) on the selected channel. A high is a voltage level that is greater than the channel's trigger level or threshold level.
- **X** sets the pattern to don't care on the selected channel. Any channel set to don't care is ignored and is not used as part of the pattern. However, if all channels in the pattern are set to don't care, the oscilloscope will not trigger.
- The rising edge () or falling edge () softkey sets the pattern to an edge on the selected channel. Only one rising or falling edge can be specified in the pattern. When an edge is specified, the oscilloscope will trigger at the edge specified if the pattern set for the other channels is true.

If no edge is specified, the oscilloscope will trigger on the last edge that makes the pattern true.

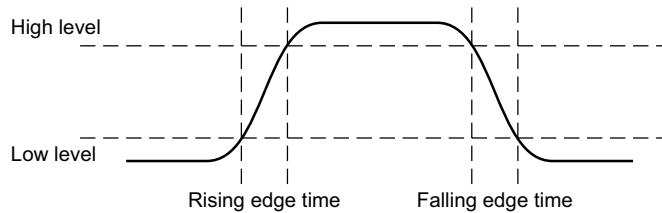
## NOTE

### Specifying an Edge in a Pattern

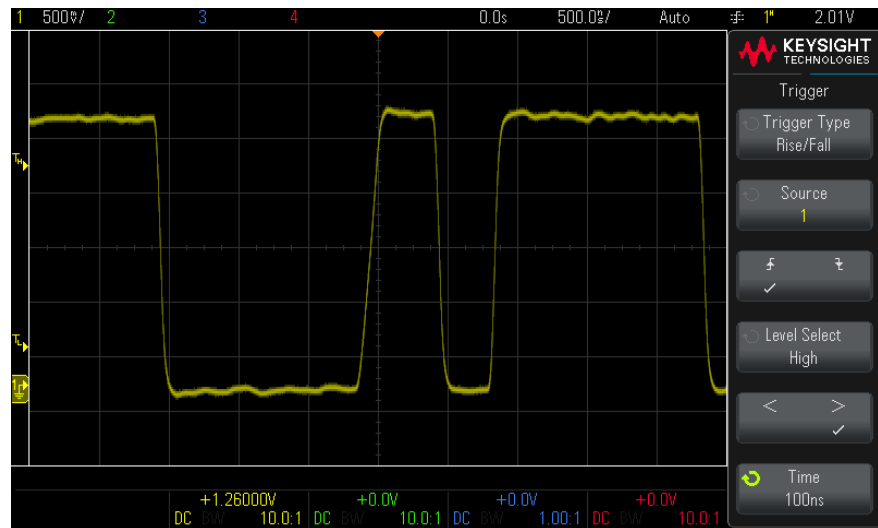
You are allowed to specify only one rising or falling edge term in the pattern. If you define an edge term, then select a different channel in the pattern and define another edge term, the previous edge definition is changed to a don't care.

## Rise/Fall Time Trigger

On DSOX1200-Series oscilloscopes, the Rise/Fall Time trigger looks for a rising or falling transition from one level to another level in greater than or less than a certain amount of time.



- 1 Press the **[Trigger]** key.
- 2 In the Trigger menu, press the **Trigger Type** softkey.
- 3 Press the **Trigger Type** softkey; then, turn the Entry knob to select **Rise/Fall Time**.



- 4 Press the **Source** softkey, and turn the Entry knob to select the input channel source.

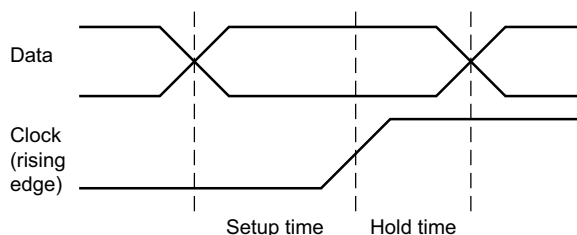
- 5 Press the **Rising Edge or Falling Edge** softkey to toggle between edge types.
- 6 Press the **Level Select** softkey to select **High**; then, turn the Trigger Level knob to adjust the high level.
- 7 Press the **Level Select** softkey to select **Low**; then, turn the Trigger Level knob to adjust the low level.

You can also push the Trigger Level knob to toggle between **High** and **Low** selection.

- 8 Press the **Qualifier** softkey to toggle between "greater than" or "less than".
- 9 Press the **Time** softkey, and turn the Entry knob to select the time.

## Setup and Hold Trigger

On DSOX1200-Series oscilloscopes, the Setup and Hold trigger looks for setup and hold violations.

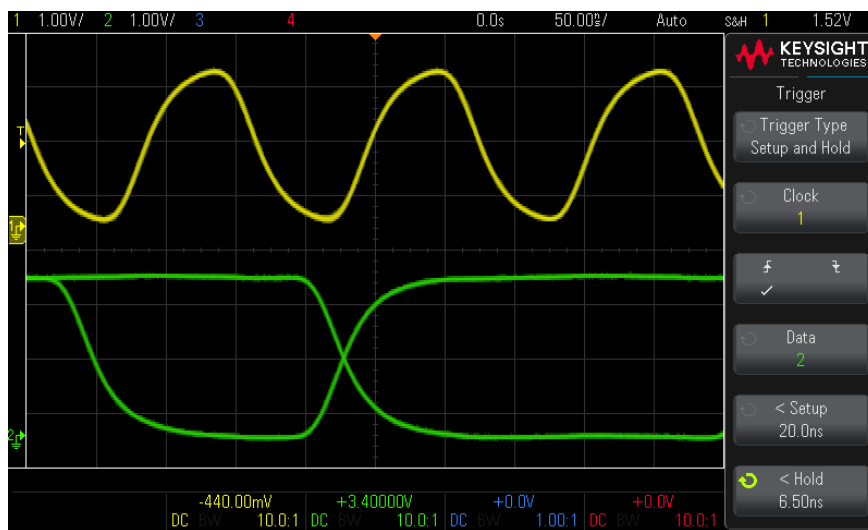


One oscilloscope channel probes the clock signal and another channel probes the data signal.

To trigger on setup & hold violations:

- 1 Press the **[Trigger]** key.
- 2 In the Trigger menu, press the **Trigger Type** softkey.
- 3 Press the **Trigger Type** softkey; then, turn the Entry knob to select **Setup and Hold**.
- 4 Press the **Clock** softkey; then, turn the Entry knob to select the input channel with the clock signal.
- 5 Set the appropriate trigger level for the clock signal using the Trigger Level knob.

- 6 Press the **Rising Edge or Falling Edge** softkey to specify the clock edge being used.
- 7 Press the **Data** softkey; then, turn the Entry knob to select the input channel with the data signal.
- 8 Set the appropriate trigger level for the data signal using the Trigger Level knob.
- 9 Press the **< Setup** softkey, and turn the Entry knob to select the setup time.



- 10 Press the **< Hold** softkey, and turn the Entry knob to select the hold time.

## Video Trigger

Video triggering can be used to capture the complicated waveforms of most standard analog video signals. The trigger circuitry detects the vertical and horizontal interval of the waveform and produces triggers based on the video trigger settings you have selected.

The oscilloscope's MegaZoom IV technology gives you bright, easily viewed displays of any part of the video waveform. Analysis of video waveforms is simplified by the oscilloscope's ability to trigger on any selected line of the video signal.

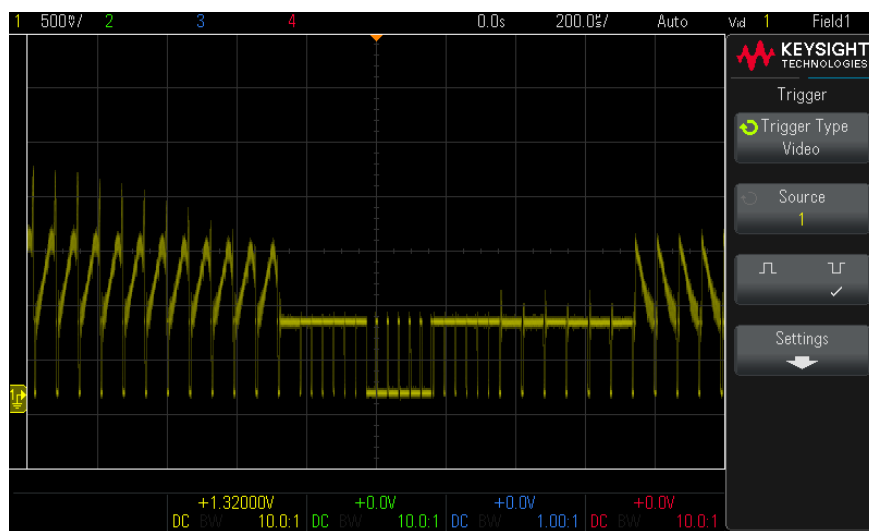
**NOTE**

Video triggering is not available when serial decode is on.

**NOTE**

It is important, when using a 10:1 passive probe, that the probe is correctly compensated. The oscilloscope is sensitive to this and will not trigger if the probe is not properly compensated, especially for progressive formats.

- 1 Press the **[Trigger]** key.
- 2 In the Trigger menu, press the **Trigger Type** softkey.
- 3 Press the **Trigger Type** softkey; then, turn the Entry knob to select **Video**.



- 4 Press the **Source** softkey and select any analog channel as the video trigger source.

The selected trigger source is displayed in the upper-right corner of the display. Turning the Trigger **Level** knob does not change the trigger level because the trigger level is automatically set to the sync pulse. Trigger coupling is automatically set to **TV** in the Trigger menu.

**NOTE****Provide Correct Matching**

Many video signals are produced from 75  $\Omega$  sources. To provide correct matching to these sources, a 75  $\Omega$  terminator (such as a Keysight 11094B) should be connected to the oscilloscope input.

- 5 Press the sync polarity softkey to set the Video trigger to either positive ( $\square$ ) or negative ( $\square$ ) sync polarity.
- 6 Press the **Settings** softkey.



- 7 In the Video Trigger menu, press the **Standard** softkey to set the video standard. The oscilloscope supports triggering on the following television (TV) and video standards.

Standard	Type	Sync Pulse
NTSC	Interlaced	Bi-level
PAL	Interlaced	Bi-level
PAL-M	Interlaced	Bi-level
SECAM	Interlaced	Bi-level

- 8** Press the **Auto Setup** softkey to automatically set up the oscilloscope for the selected **Source** and **Standard**:
- Source channel vertical scaling is set to 140 mV/div.
  - Source channel offset is set to 245 mV.
  - Source channel is turned on.
  - Trigger type is set to **Video**.
  - Video trigger mode is set to **All Lines**.
  - Display **Grid** type is set to **IRE** (when **Standard** is **NTSC**) or **mV** (see "**To select the grid type**" on page 86).
  - Horizontal time/division is set to 10  $\mu$ s/div for NTSC/PAL/SECAM standards.
  - Horizontal delay is set so that trigger is at first horizontal division from the left.

You can also press **[Analyze]> Features** and then select **Video** to quickly access the video triggering automatic set up and display options.

- 9** Press the **Mode** softkey to select the portion of the video signal that you would like to trigger on.

The Video trigger modes available are:

- **Field1** and **Field2** – Trigger on the rising edge of the first serration pulse of field 1 or field 2 (interlaced standards only).
- **All Fields** – Trigger on the rising edge of the first pulse in the vertical sync interval.
- **All Lines** – Trigger on all horizontal sync pulses.
- **Line: Field1** and **Line:Field2** – Trigger on the selected line # in field 1 or field 2 (interlaced standards only).
- **Line: Alternate** – Alternately trigger on the selected line # in field 1 and field 2 (NTSC, PAL, PAL-M, and SECAM only).

**10** If you select a line # mode, press the **Line #** softkey, then rotate the Entry knob to select the line number on which you want to trigger.

The following table lists the line (or count) numbers per field for each video standard.

Video standard	Field 1	Field 2	Alt Field
NTSC	1 to 263	1 to 262	1 to 262
PAL	1 to 313	314 to 625	1 to 312
PAL-M	1 to 263	264 to 525	1 to 262
SECAM	1 to 313	314 to 625	1 to 312

#### Video Triggering Examples

The following are exercises to familiarize you with video triggering. These exercises use the NTSC video standard.

- "To trigger on a specific line of video" on page 112
- "To trigger on all sync pulses" on page 113
- "To trigger on a specific field of the video signal" on page 114
- "To trigger on all fields of the video signal" on page 115
- "To trigger on odd or even fields" on page 116

#### To trigger on a specific line of video

Video triggering requires greater than 1/2 division of sync amplitude with any analog channel as the trigger source. Turning the trigger **Level** knob in Video trigger does not change the trigger level because the trigger level is automatically set to the sync pulse tips.

One example of triggering on a specific line of video is looking at the vertical interval test signals (VITS), which are typically in line 18. Another example is closed captioning, which is typically in line 21.

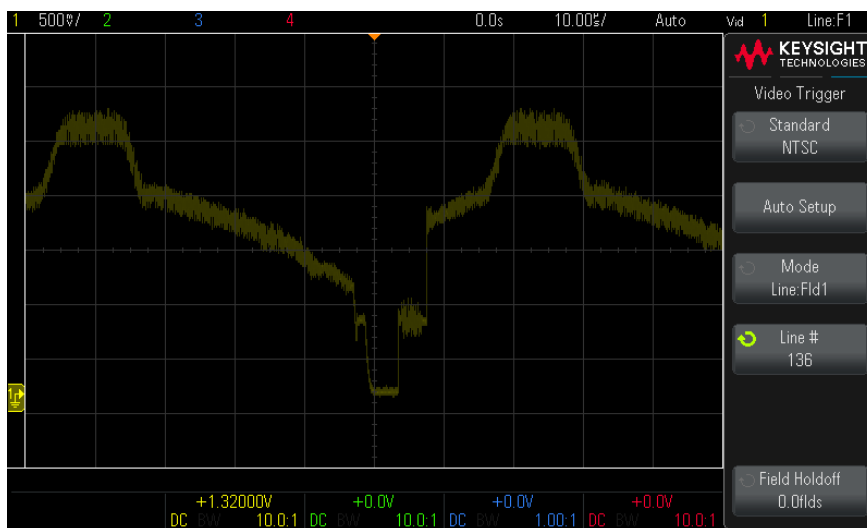
- 1** Press the **[Trigger]** key.
- 2** In the Trigger menu, press the **Trigger Type** softkey.
- 3** Press the **Trigger Type** softkey; then, turn the Entry knob to select **Video**.
- 4** Press the **Settings** softkey, then press the **Standard** softkey to select the appropriate TV standard (NTSC).



- 5 Press the **Mode** softkey and select the TV field of the line you want to trigger on. You can choose **Line:Field1**, **Line:Field2**, or **Line:Alternate**.
- 6 Press the **Line #** softkey and select the number of the line you want to examine.

**NOTE****Alternate Triggering**

If **Line:Alternate** is selected, the oscilloscope will alternately trigger on the selected line number in Field 1 and Field 2. This is a quick way to compare the Field 1 VITS and Field 2 VITS or to check for the correct insertion of the half line at the end of Field 1.



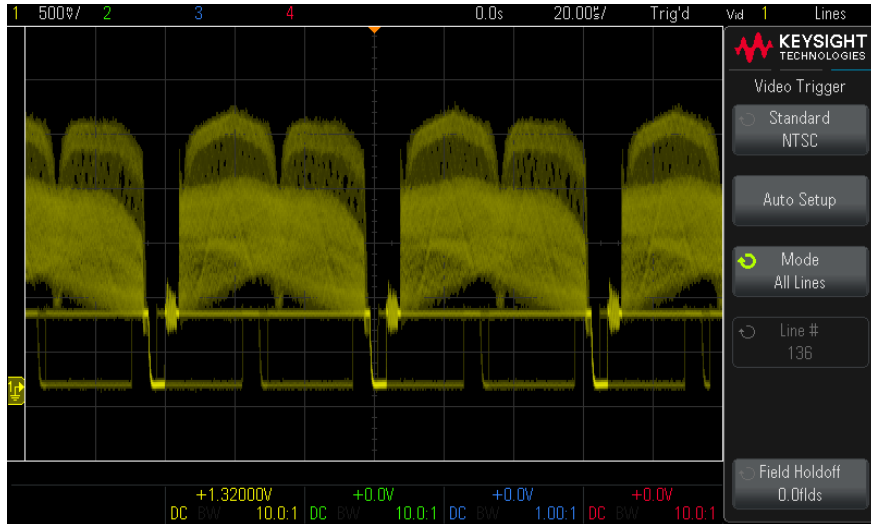
**Figure 15** Example: Triggering on Line 136

### To trigger on all sync pulses

To quickly find maximum video levels, you could trigger on all sync pulses. When **All Lines** is selected as the Video trigger mode, the oscilloscope will trigger on all horizontal sync pulses.

- 1 Press the **[Trigger]** key.
- 2 In the Trigger menu, press the **Trigger Type** softkey.
- 3 Press the **Trigger Type** softkey; then, turn the Entry knob to select **Video**.

- 4 Press the **Settings** softkey, then press the **Standard** softkey to select the appropriate TV standard.
- 5 Press the **Mode** softkey and select **All Lines**.

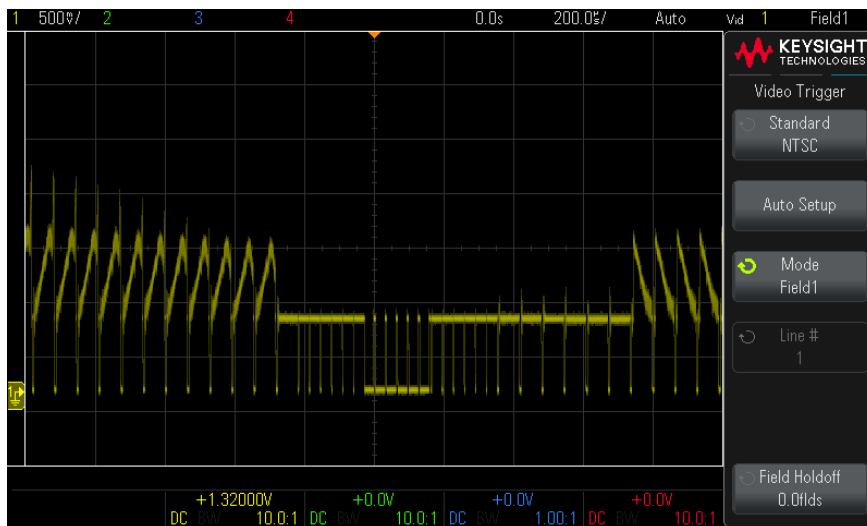


**Figure 16** Triggering on All Lines

To trigger on a specific field of the video signal

To examine the components of a video signal, trigger on either Field 1 or Field 2 (available for interleaved standards). When a specific field is selected, the oscilloscope triggers on the rising edge of the first serration pulse in the vertical sync interval in the specified field (1 or 2).

- 1 Press the **[Trigger]** key.
- 2 In the Trigger menu, press the **Trigger Type** softkey.
- 3 Press the **Trigger Type** softkey; then, turn the Entry knob to select **Video**.
- 4 Press the **Settings** softkey, then press the **Standard** softkey to select the appropriate TV standard.
- 5 Press the **Mode** softkey and select **Field1** or **Field2**.

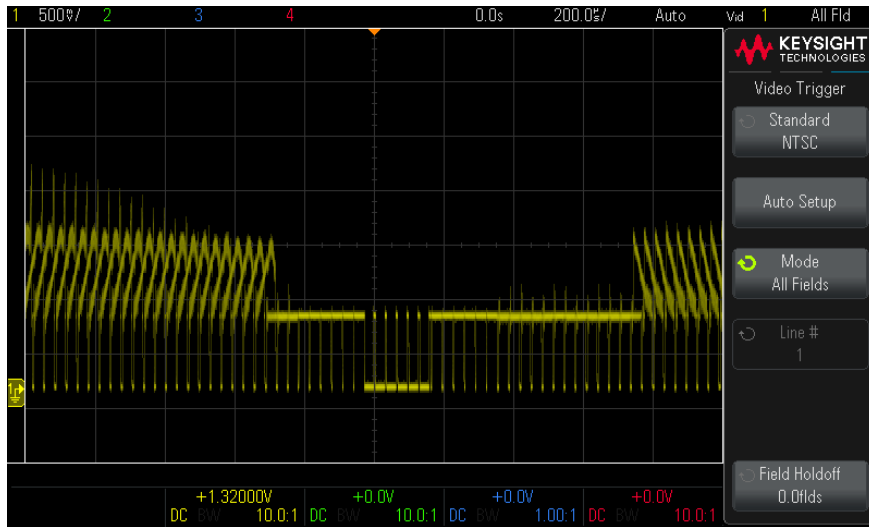


**Figure 17** Triggering on Field 1

To trigger on all fields of the video signal

To quickly and easily view transitions between fields, or to find the amplitude differences between the fields, use the All Fields trigger mode.

- 1 Press the **[Trigger]** key.
- 2 In the Trigger menu, press the **Trigger Type** softkey.
- 3 Press the **Trigger Type** softkey; then, turn the Entry knob to select **Video**.
- 4 Press the **Settings** softkey, then press the **Standard** softkey to select the appropriate TV standard.
- 5 Press the **Mode** softkey and select **All Fields**.



**Figure 18** Triggering on All Fields

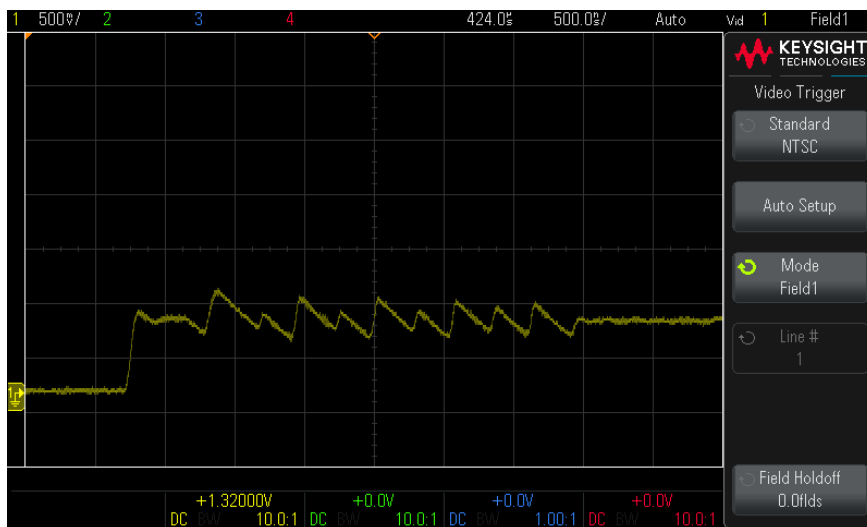
## To trigger on odd or even fields

To check the envelope of your video signals, or to measure worst case distortion, trigger on the odd or even fields. When Field 1 is selected, the oscilloscope triggers on color fields 1 or 3. When Field 2 is selected, the oscilloscope triggers on color fields 2 or 4.

- 1 Press the **[Trigger]** key.
- 2 In the Trigger menu, press the **Trigger Type** softkey.
- 3 Press the **Trigger Type** softkey; then, turn the Entry knob to select **Video**.
- 4 Press the **Settings** softkey, then press the **Standard** softkey to select the appropriate TV standard.
- 5 Press the **Mode** softkey and select **Field1** or **Field2**.

The trigger circuits look for the position of the start of Vertical Sync to determine the field. But this definition of field does not take into consideration the phase of the reference subcarrier. When Field 1 is selected, the trigger system will find any field where the vertical sync starts on Line 4. In the case of NTSC video, the

oscilloscope will trigger on color field 1 alternating with color field 3 (see the following figure). This setup can be used to measure the envelope of the reference burst.



**Figure 19** Triggering on Color Field 1 Alternating with Color Field 3

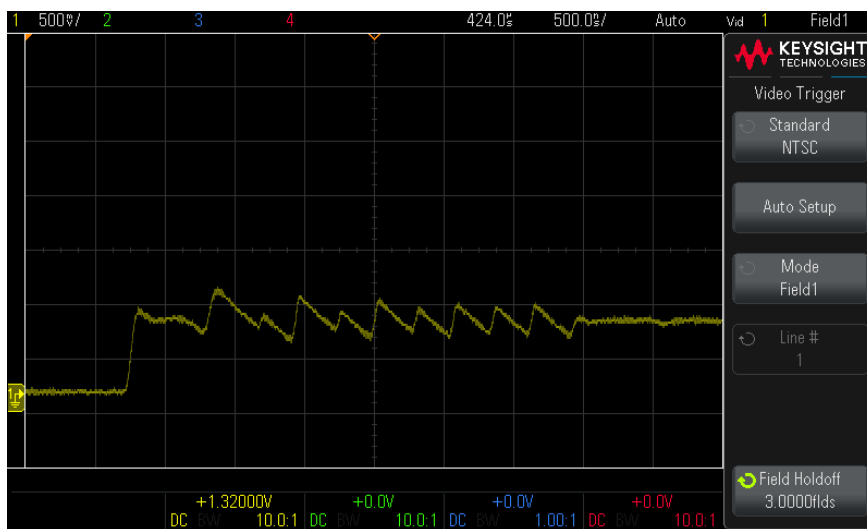
If a more detailed analysis is required, then only one color field should be selected to be the trigger. You can do this by using the **Field Holdoff** softkey in the Video Trigger menu. Press the **Field Holdoff** softkey and use the Entry knob to adjust the holdoff in half-field increments until the oscilloscope triggers on only one phase of the color burst.

A quick way to synchronize to the other phase is to briefly disconnect the signal and then reconnect it. Repeat until the correct phase is displayed.

When holdoff is adjusted using the **Field Holdoff** softkey and the Entry knob, the corresponding holdoff time will be displayed in the Trigger menu.

**Table 2** Half-field holdoff time

Standard	Time
NTSC	8.35 ms
PAL	10 ms
PAL-M	10 ms
SECAM	10 ms

**Figure 20** Using Field Holdoff to Synchronize to Color Field 1 or 3 (Field 1 mode)

## Serial Trigger

With serial decode features (see [Chapter 8](#), “Serial Bus Decode/Trigger,” starting on page 81), you can enable serial trigger types. To set up these triggers, see:

- ["CAN Triggering"](#) on page 279
- ["I2C Triggering"](#) on page 288
- ["LIN Triggering"](#) on page 297

- ["SPI Triggering"](#) on page 309
- ["UART/RS232 Triggering"](#) on page 317

## 11 Triggers



# 12 Trigger Mode/Coupling

To select the Auto or Normal trigger mode / 122

To select the trigger coupling / 124

To enable or disable trigger noise rejection / 125

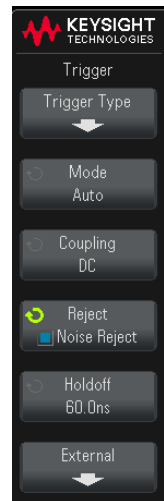
To enable or disable trigger HF Reject / 125

To set the trigger holdoff / 126

External Trigger Input / 127

To access the trigger mode and coupling options:

- In the Trigger section of the front panel, press the **[Trigger]** key.



- Noisy Signals** If the signal you are probing is noisy, you can set up the oscilloscope to reduce the noise in the trigger path and on the displayed waveform. First, stabilize the displayed waveform by removing the noise from the trigger path. Second, reduce the noise on the displayed waveform.
- 1 Connect a signal to the oscilloscope and obtain a stable display.
  - 2 Remove the noise from the trigger path by turning on high-frequency rejection ("**To enable or disable trigger HF Reject**" on page 125), low-frequency rejection ("**To select the trigger coupling**" on page 124), or "**To enable or disable trigger noise rejection**" on page 125.
  - 3 Use "**Averaging Acquisition Mode**" on page 138 to reduce noise on the displayed waveform.

### To select the Auto or Normal trigger mode

When the oscilloscope is running, the trigger mode tells the oscilloscope what to do when triggers are not occurring.

In the **Auto** trigger mode (the default setting), if the specified trigger conditions are not found, triggers are forced and acquisitions are made so that signal activity is displayed on the oscilloscope.

In the **Normal** trigger mode, triggers and acquisitions occur only when the specified trigger conditions are found.

To select the trigger mode:

- 1 Press the **[Trigger]** key.
- 2 In the Trigger menu, press the **Mode** softkey; then select either **Auto** or **Normal**.

See the following "**When to Use Auto Trigger Mode**" on page 123 and "**When to Use Normal Trigger Mode**" on page 123 descriptions.

You can also configure the **[Quick Action]** key to toggle between the Auto and Normal trigger modes. See "**Configuring the [Quick Action] Key**" on page 248.

#### Triggering and the Pre- and Post-Trigger Buffers

After the oscilloscope starts running (after pressing **[Run]** or **[Single]** or changing the trigger condition), the oscilloscope first fills the pre-trigger buffer. Then, after the pre-trigger buffer is filled, the oscilloscope starts searching for a trigger, and sampled data continues to flow data through the pre-trigger buffer in a first-in first-out (FIFO) manner.

When a trigger is found, the pre-trigger buffer contains the events that occurred just before the trigger. Then, the oscilloscope fills the post-trigger buffer and displays the acquisition memory. If the acquisition was initiated by **[Run/Stop]**, the process repeats. If the acquisition was initiated by pressing **[Single]**, the acquisition stops (and you can Pan and Zoom the waveform).

In either Auto or Normal trigger mode, a trigger may be missed if the event occurs while the pre-trigger buffer is being filled. This may be more likely, for example, when the horizontal scale knob is set to a slow time/div setting, such as 500 ms/div.

**Trigger Indicator** The trigger indicator at the top right of the display shows whether triggers are occurring.

In the **Auto** trigger mode, the trigger indicator can show:

- **Auto?** (flashing) – the trigger condition is not found (after the pre-trigger buffer has filled), and forced triggers and acquisitions are occurring.
- **Auto** (not flashing) – the trigger condition is found (or the pre-trigger buffer is being filled).

In the **Normal** trigger mode, the trigger indicator can show:

- **Trig'd?** (flashing) – the trigger condition is not found (after the pre-trigger buffer has filled), and no acquisitions are occurring.
- **Trig'd** (not flashing) – trigger condition is found (or pre-trigger buffer is being filled).

When the oscilloscope is not running, the trigger indicator area shows **Stop**.

**When to Use Auto Trigger Mode** The **Auto** trigger mode is appropriate when:

- Checking DC signals or signals with unknown levels or activity.
- When trigger conditions occur often enough that forced triggers are unnecessary.

**When to Use Normal Trigger Mode** The **Normal** trigger mode is appropriate when:

- You want to acquire only specific events specified by the trigger settings.
- Triggering on an infrequent signal from a serial bus (for example, I2C, SPI, CAN, LIN, etc.) or another signal that arrives in bursts. The **Normal** trigger mode lets you stabilize the display by preventing the oscilloscope from auto-triggering.
- Making single-shot acquisitions with the **[Single]** key.

Often with single-shot acquisitions, you must initiate some action in the device under test, and you don't want the oscilloscope to auto-trigger before that happens. Before initiating the action in the circuit, wait for the trigger condition indicator **Trig'd?** to flash (this tells you the pre-trigger buffer is filled).

- See Also
- **"Forcing a Trigger"** on page 99
  - **"To set the trigger holdoff"** on page 126
  - **"To position the time reference (left, center, right)"** on page 46

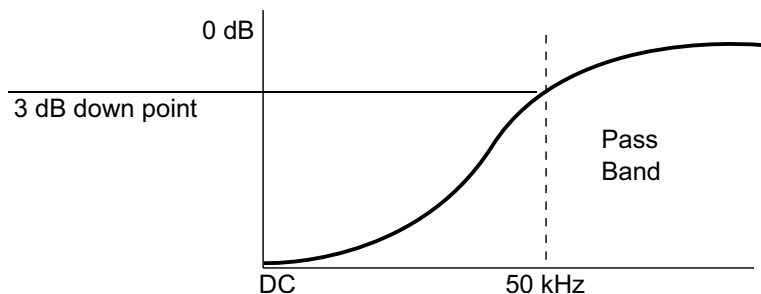
## To select the trigger coupling

- 1 Press the **[Trigger]** key.
- 2 In the Trigger menu, press the **Coupling** softkey; then, turn the Entry knob to select:
  - **DC** coupling – allows DC and AC signals into the trigger path.
  - **AC** coupling – places a 10 Hz high-pass filter in the trigger path removing any DC offset voltage from the trigger waveform.

The high-pass filter in the External Trigger input path is 50 Hz for all models.

Use AC coupling to get a stable edge trigger when your waveform has a large DC offset.

- **LF (low frequency) Reject** coupling – adds a high-pass filter with the 3-dB point at 50 kHz in series with the trigger waveform.



Low frequency reject removes any unwanted low frequency components from a trigger waveform, such as power line frequencies, etc., that can interfere with proper triggering.

Use **LF Reject** coupling to get a stable edge trigger when your waveform has low frequency noise.

- **TV** coupling – is normally grayed-out, but is automatically selected when Video trigger is enabled in the Trigger menu.

Note that Trigger Coupling is independent of Channel Coupling (see "**To specify channel coupling**" on page 50).

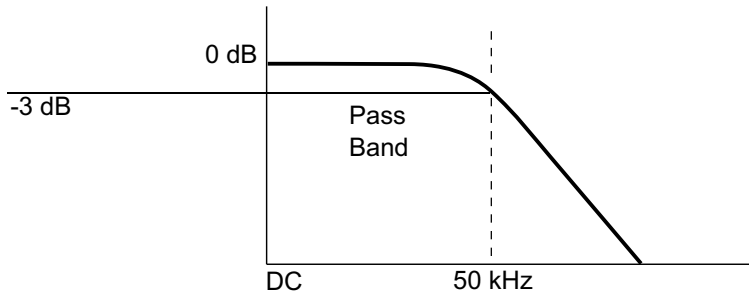
## To enable or disable trigger noise rejection

Noise Rej adds additional hysteresis to the trigger circuitry. By increasing the trigger hysteresis band, you reduce the possibility of triggering on noise. However, this also decreases the trigger sensitivity so that a slightly larger signal is required to trigger the oscilloscope.

- 1** Press the **[Trigger]** key.
- 2** In the Trigger menu, press **Reject**; then, select **Noise Reject**.
- 3** Press **Reject** again (or push the Entry knob) to enable or disable.

## To enable or disable trigger HF Reject

HF Reject adds a 50 kHz low-pass filter in the trigger path to remove high frequency components from the trigger waveform.



You can use HF Reject to remove high-frequency noise, such as AM or FM broadcast stations or noise from fast system clocks, from the trigger path.

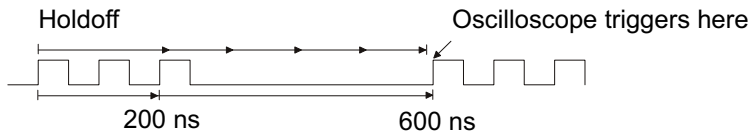
- 1 Press the **[Trigger]** key.
- 2 In the Trigger menu, press **Reject**; then, select **HF Reject**.
- 3 Press **Reject** again (or push the Entry knob) to enable or disable.

## To set the trigger holdoff

Trigger holdoff sets the amount of time the oscilloscope waits after a trigger before re-arming the trigger circuitry.

Use the holdoff to trigger on repetitive waveforms that have multiple edges (or other events) between waveform repetitions. You can also use holdoff to trigger on the first edge of a burst when you know the minimum time between bursts.

For example, to get a stable trigger on the repetitive pulse burst shown below, set the holdoff time to be  $>200$  ns but  $<600$  ns.



To set the trigger holdoff:

- 1 Press the **[Trigger]** key.

- 2 In the Trigger menu, press the **Holdoff** softkey; then, turn the Entry knob to increase or decrease the trigger holdoff time.

### Trigger Holdoff Operating Hints

The correct holdoff setting is typically slightly less than one repetition of the waveform. Set the holdoff to this time to generate a unique trigger point for a repetitive waveform.

Changing the time base settings does not affect the trigger holdoff time.

With Keysight's MegaZoom technology, you can press **[Stop]**, then pan and zoom through the data to find where the waveform repeats. Measure this time using cursors; then, set the holdoff.

## External Trigger Input

The external trigger input can be used as a source in several of the trigger types.

On 4-channel oscilloscopes, the external trigger BNC input is on the rear panel and is labeled **EXT TRIG**.

On 2-channel oscilloscopes, the external trigger BNC input is on the front panel and is labeled **Ext Trig**.

### CAUTION

#### Maximum voltage at oscilloscope external trigger input

30 Vrms, 40 Vpk

The external trigger input impedance is 1M Ohm. This lets you use passive probes for general-purpose measurements. The higher impedance minimizes the loading effect of the oscilloscope on the device under test.

To set the external trigger input options:

- 1 Access the External Trigger menu:
  - On 4-channel oscilloscopes:
    - i Press the **[Trigger]** key in the Trigger section of the front panel.
    - ii In the Trigger menu, press the **External** softkey.
  - On 2-channel oscilloscopes, press the **[External]** key in the Vertical section of the front panel.

The **[External]** key also displays the Ext Trig signal's digital waveform. If the External Trigger menu is already open, pressing **[External]** turns the Ext Trig waveform display off or on.

The Ext Trig signal's digital waveform is based on its threshold voltage level setting.

The external trigger digital waveform view is not available when the XY time mode is selected or when the Averaging or High Resolution acquisition modes are selected. On EDUX1000-Series oscilloscopes, additionally, the external waveform view is not available when the trigger source is not "Ext", when the Roll time mode is selected, or when serial bus decode is enabled.

- 2 In the External Trigger menu, press the **Units** softkey to select between:

- **Volts** – for a voltage probe.
- **Amps** – for a current probe.

Measurement results, channel sensitivity, and the trigger level will reflect the measurement units you have selected.

- 3 Press the **Probe** softkey; then, turn the entry knob to specify the probe attenuation.

The attenuation factor can be set from 0.1:1 to 1000:1 in a 1-2-5 sequence.

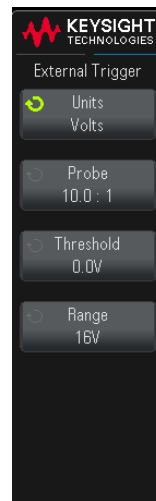
The probe attenuation factor must be set properly for measurements to be made correctly.

- 4 Press the **Threshold** softkey; then, turn the Entry knob to set the threshold voltage for the External Trigger input signal.
- 5 On DSOX1200-Series oscilloscopes, press the **Range** softkey; then, turn the Entry knob to set the External Trigger input signal range. When using a 1:1 probe, the Ext Trig input signal range is either 1.6 V or 8 V.

On EDUX1000-Series oscilloscopes, when using a 1:1 probe, the Ext Trig input signal range is fixed at 8 V (and there is no **Range** softkey).

The range is automatically recalculated when a different External Trigger probe attenuation factor is chosen.

- 6 On 2-channel oscilloscopes, press the **Position** softkey; then, turn the Entry knob to adjust the vertical position of the Ext Trig signal's digital waveform.





# 13 Acquisition Control

Running, Stopping, and Making Single Acquisitions (Run Control) / 129

Overview of Sampling / 130

Selecting the Acquisition Mode / 135

Acquiring to Segmented Memory / 141

This chapter shows how to use the oscilloscope's acquisition and run controls.

## Running, Stopping, and Making Single Acquisitions (Run Control)

There are two front panel keys for starting and stopping the oscilloscope's acquisition system: **[Run/Stop]** and **[Single]**.

- When the **[Run/Stop]** key is green, the oscilloscope is running, that is, acquiring data when trigger conditions are met.

To stop acquiring data, press **[Run/Stop]**. When stopped, the last acquired waveform is displayed.

- When the **[Run/Stop]** key is red, data acquisition is stopped.

"Stop" is displayed next to the trigger type in the status line at the top of the display.

To start acquiring data, press **[Run/Stop]**.

- To capture and display a single acquisition (whether the oscilloscope is running or stopped), press **[Single]**.

The **[Single]** run control lets you view single-shot events without subsequent waveform data overwriting the display. Use **[Single]** when you want maximum memory depth for pan and zoom.

When you press **[Single]**, the display is cleared, the trigger mode is temporarily set to Normal (to keep the oscilloscope from auto-triggering immediately), the trigger circuitry is armed, the **[Single]** key is illuminated, and the oscilloscope waits until a trigger condition occurs before it displays a waveform.

When the oscilloscope triggers, the single acquisition is displayed and the oscilloscope is stopped (the **[Run/Stop]** key is illuminated in red). Press **[Single]** again to acquire another waveform.

If the oscilloscope doesn't trigger, you can press the **[Force]** key to trigger on anything and make a single acquisition.

To display the results of multiple acquisitions, use persistence. See "**To set or clear persistence**" on page 85.

### Single vs. Running and Record Length

The maximum data record length is greater for a single acquisition than when the oscilloscope is running (or when the oscilloscope is stopped after running):

- **Single** – Single acquisitions always use the maximum memory available – at least twice as much memory as acquisitions captured when running – and the oscilloscope stores at least twice as many samples. At slower time/div settings, because there is more memory available for a single acquisition, the acquisition has a higher effective sample rate.
- **Running** – When running (versus taking a single acquisition), the memory is divided in half. This lets the acquisition system acquire one record while processing the previous acquisition, dramatically improving the number of waveforms per second processed by the oscilloscope. When running, a high waveform update rate provides the best representation of your input signal.

To acquire data with the longest possible record length, press the **[Single]** key.

For more information on settings that affect record length, see "**Length Control**" on page 221.

## Overview of Sampling

To understand the oscilloscope's sampling and acquisition modes, it is helpful to understand sampling theory, aliasing, oscilloscope bandwidth and sample rate, oscilloscope rise time, oscilloscope bandwidth required, and how memory depth affects sample rate.

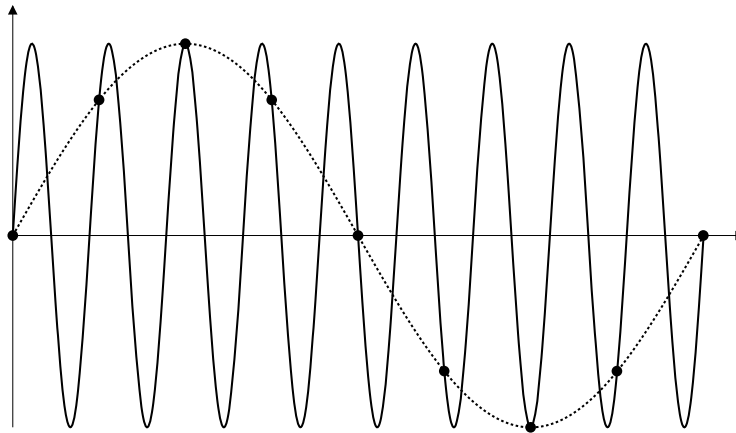
## Sampling Theory

The Nyquist sampling theorem states that for a limited bandwidth (band-limited) signal with maximum frequency  $f_{MAX}$ , the equally spaced sampling frequency  $f_S$  must be greater than twice the maximum frequency  $f_{MAX}$ , in order to have the signal be uniquely reconstructed without aliasing.

$$f_{MAX} = f_S/2 = \text{Nyquist frequency } (f_N) = \text{folding frequency}$$

## Aliasing

Aliasing occurs when signals are under-sampled ( $f_S < 2f_{MAX}$ ). Aliasing is the signal distortion caused by low frequencies falsely reconstructed from an insufficient number of sample points.

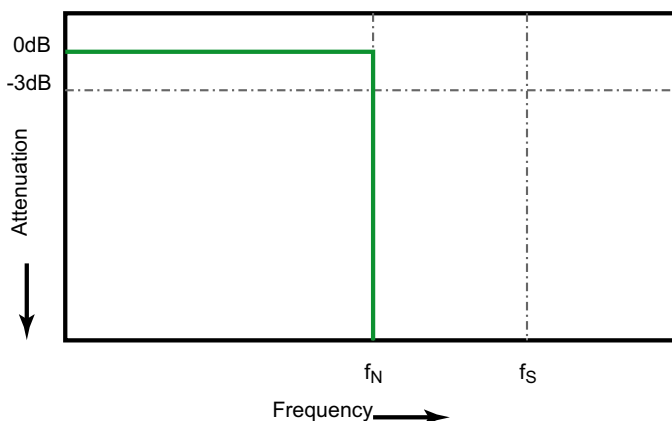


**Figure 21** Aliasing

## Oscilloscope Bandwidth and Sample Rate

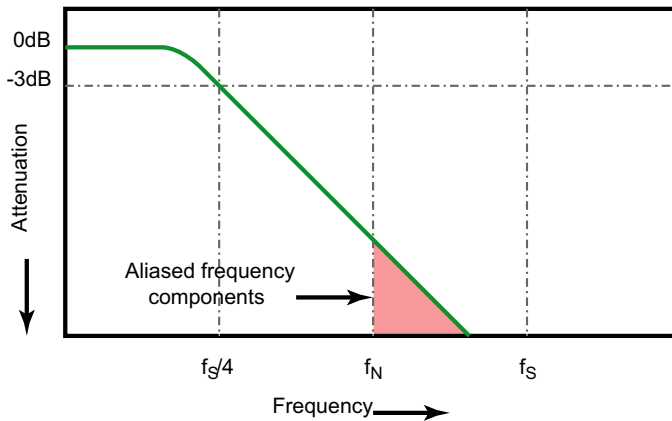
An oscilloscope's bandwidth is typically described as the lowest frequency at which input signal sine waves are attenuated by 3 dB (-30% amplitude error).

At the oscilloscope bandwidth, sampling theory says the required sample rate is  $f_S = 2f_{BW}$ . However, the theory assumes there are no frequency components above  $f_{MAX}$  ( $f_{BW}$  in this case) and it requires a system with an ideal brick-wall frequency response.



**Figure 22** Theoretical Brick-Wall Frequency Response

However, digital signals have frequency components above the fundamental frequency (square waves are made up of sine waves at the fundamental frequency and an infinite number of odd harmonics), and typically, for 500 MHz bandwidths and below, oscilloscopes have a Gaussian frequency response.



Limiting oscilloscope bandwidth (fbw) to 1/4 the sample rate ( $f_s/4$ ) reduces frequency components above the Nyquist frequency ( $f_N$ ).

**Figure 23** Sample Rate and Oscilloscope Bandwidth

So, in practice, an oscilloscope's sample rate should be four or more times its bandwidth:  $f_s = 4f_{BW}$ . This way, there is less aliasing, and aliased frequency components have a greater amount of attenuation.

**See Also** *Evaluating Oscilloscope Sample Rates vs. Sampling Fidelity: How to Make the Most Accurate Digital Measurements*, Keysight Application Note 1587 (<http://literature.cdn.keysight.com/litweb/pdf/5989-5732EN.pdf>)

## Oscilloscope Rise Time

Closely related to an oscilloscope's bandwidth specification is its rise time specification. Oscilloscopes with a Gaussian-type frequency response have an approximate rise time of  $0.35/f_{BW}$  based on a 10% to 90% criterion.

An oscilloscope's rise time is not the fastest edge speed that the oscilloscope can accurately measure. It is the fastest edge speed the oscilloscope can possibly produce.

## Oscilloscope Bandwidth Required

The oscilloscope bandwidth required to accurately measure a signal is primarily determined by the signal's rise time, not the signal's frequency. You can use these steps to calculate the oscilloscope bandwidth required:

- 1 Determine the fastest edge speeds.

You can usually obtain rise time information from published specifications for devices used in your designs.

- 2 Compute the maximum "practical" frequency component.

From Dr. Howard W. Johnson's book, *High-Speed Digital Design – A Handbook of Black Magic*, all fast edges have an infinite spectrum of frequency components. However, there is an inflection (or "knee") in the frequency spectrum of fast edges where frequency components higher than  $f_{\text{knee}}$  are insignificant in determining the shape of the signal.

$$f_{\text{knee}} = 0.5 / \text{signal rise time (based on 10\% - 90\% thresholds)}$$

$$f_{\text{knee}} = 0.4 / \text{signal rise time (based on 20\% - 80\% thresholds)}$$

- 3 Use a multiplication factor for the required accuracy to determine the oscilloscope bandwidth required.

Required accuracy	Oscilloscope bandwidth required
20%	$f_{\text{BW}} = 1.0 \times f_{\text{knee}}$
10%	$f_{\text{BW}} = 1.3 \times f_{\text{knee}}$
3%	$f_{\text{BW}} = 1.9 \times f_{\text{knee}}$

**See Also** *Choosing an Oscilloscope with the Right Bandwidth for your Application*, Keysight Application Note 1588  
<http://literature.cdn.keysight.com/litweb/pdf/5989-5733EN.pdf>

## Memory Depth and Sample Rate

The number of points of oscilloscope memory is fixed, and there is a maximum sample rate associated with oscilloscope's analog-to-digital converter; however, the actual sample rate is determined by the time of the acquisition (which is set according to the oscilloscope's horizontal time/div scale).

sample rate = number of samples / time of acquisition

For example, when storing 50  $\mu$ s of data in 50,000 points of memory, the actual sample rate is 1 GSa/s.

Likewise, when storing 50 ms of data in 50,000 points of memory, the actual sample rate is 1 MSa/s.

The actual sample rate is displayed in the right-side information area when softkey menus are off.

The oscilloscope achieves the actual sample rate by throwing away (decimating) unneeded samples.

## Selecting the Acquisition Mode

When selecting the oscilloscope acquisition mode, keep in mind that samples are normally decimated at slower time/div settings.

At slower time/div settings, the effective sample rate drops (and the effective sample period increases) because the acquisition time increases and the oscilloscope's digitizer is sampling faster than is required to fill memory.

For example, suppose an oscilloscope's digitizer has a sample period of 1 ns (maximum sample rate of 1 GSa/s) and a 1 M memory depth. At that rate, memory is filled in 1 ms. If the acquisition time is 100 ms (10 ms/div), only 1 of every 100 samples is needed to fill memory.

To select the acquisition mode:

- 1 Press the **[Acquire]** key on the front panel.
- 2 In the Acquire menu, press the **Acq Mode** softkey; then, turn the Entry knob to select the acquisition mode.

The InfiniiVision oscilloscopes have the following acquisition modes:

- **Normal** – at slower time/div settings, normal decimation occurs, and there is no averaging. Use this mode for most waveforms. See "**Normal Acquisition Mode**" on page 136.
- **Peak Detect** – at slower time/div settings, the maximum and minimum samples in the effective sample period are stored. Use this mode for displaying narrow pulses that occur infrequently. See "**Peak Detect Acquisition Mode**" on page 136.

- **Averaging** – at all time/div settings, the specified number of triggers are averaged together. Use this mode for reducing noise and increasing resolution of periodic signals without bandwidth or rise time degradation. See "**Averaging Acquisition Mode**" on page 138.
- **High Resolution** – at slower time/div settings, all samples in the effective sample period are averaged and the average value is stored. Use this mode for reducing random noise. See "**High Resolution Acquisition Mode**" on page 140.

## Normal Acquisition Mode

In Normal mode at slower time/div settings, extra samples are decimated (in other words, some are thrown away). This mode yields the best display for most waveforms.

## Peak Detect Acquisition Mode

In Peak Detect mode, at slower time/div settings when decimation would normally occur, minimum and maximum value samples are kept in order to capture infrequent and narrow events (at the expense of exaggerating any noise). This mode displays all pulses that are at least as wide as the sample period.

For InfiniiVision 1200 X-Series oscilloscopes, which have a maximum sample rate of 2 GSa/s, a sample is taken every 500 ps (sample period).

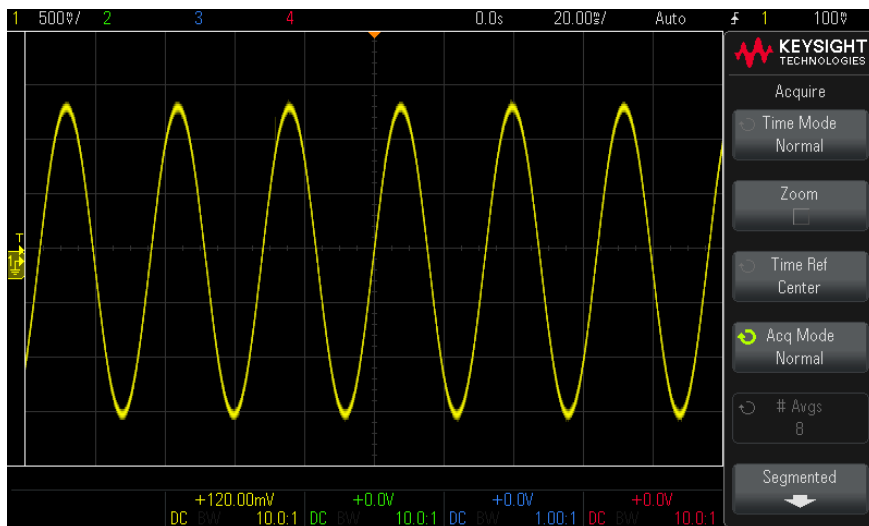
- See Also
- "**Glitch or Narrow Pulse Capture**" on page 136
  - "**Using Peak Detect Mode to Find a Glitch**" on page 138

### Glitch or Narrow Pulse Capture

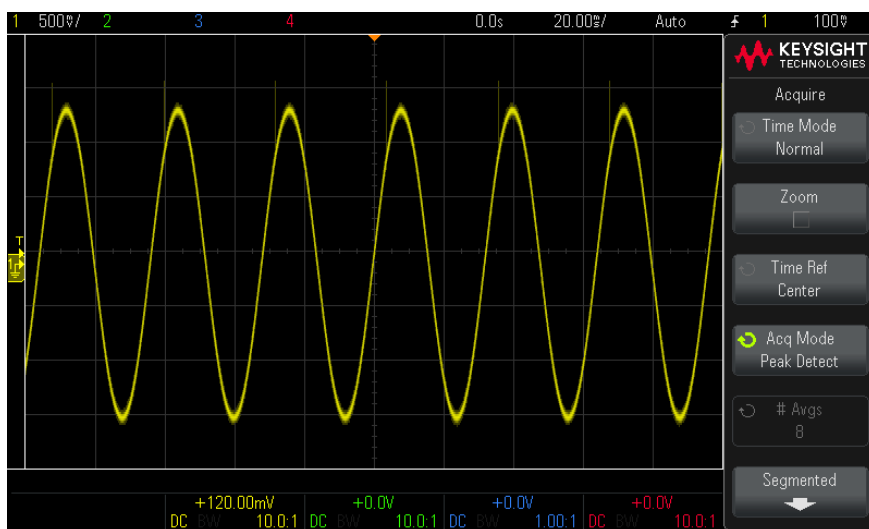
A glitch is a rapid change in the waveform that is usually narrow as compared to the waveform. Peak detect mode can be used to more easily view glitches or narrow pulses. In peak detect mode, narrow glitches and sharp edges are displayed more brightly than when in Normal acquire mode, making them easier to see.

To characterize the glitch, use the cursors or the automatic measurement capabilities of the oscilloscope.





**Figure 24** Sine With Glitch, Normal Mode




**Figure 25** Sine With Glitch, Peak Detect Mode


### Using Peak Detect Mode to Find a Glitch

- 1 Connect a signal to the oscilloscope and obtain a stable display.
- 2 To find the glitch, press the **[Acquire]** key; then, press the **Acq Mode** softkey until **Peak Detect** is selected.
- 3 Press the **[Display]** key then press the  $\infty$  **Persistence** (infinite persistence) softkey.

Infinite persistence updates the display with new acquisitions but does not erase previous acquisitions. New sample points are shown at normal intensity while previous acquisitions are displayed at reduced intensity. Waveform persistence is not kept beyond the display area boundary.

Press the **Clear Display** softkey to erase previously acquired points. The display will accumulate points until  $\infty$  **Persistence** is turned off.

- 4 Characterize the glitch with Zoom mode:
  - a Press the  zoom key (or press the **[Acquire]** key and then the **Zoom** softkey).
  - b To obtain a better resolution of the glitch, expand the time base.

Use the horizontal position knob () to pan through the waveform to set the expanded portion of the normal window around the glitch.

### Averaging Acquisition Mode

The Averaging mode lets you average multiple acquisitions together to reduce noise and increase vertical resolution (at all time/div settings). Averaging requires a stable trigger.

The number of averages can be set from 2 to 65536 in power-of-2 increments.

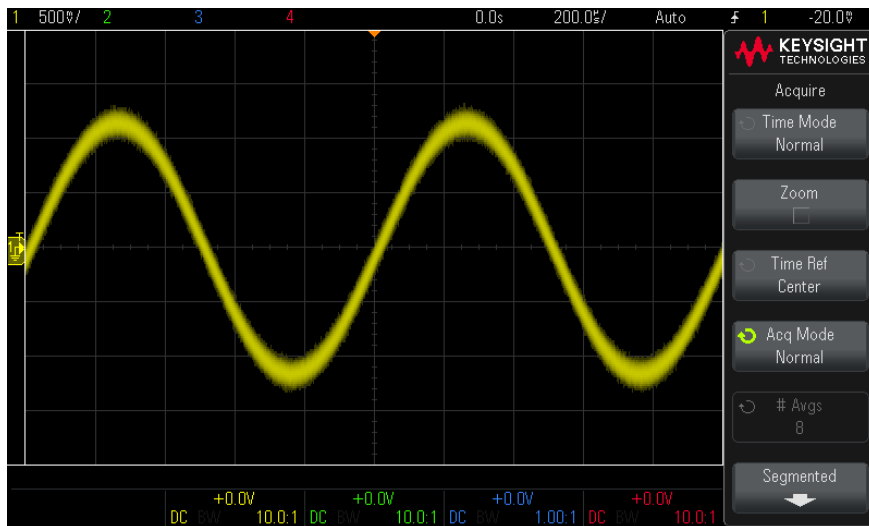
A higher number of averages reduces noise more and increases vertical resolution.

# Avgs	Bits of resolution
2	8
4	9
16	10
64	11
$\geq 256$	12

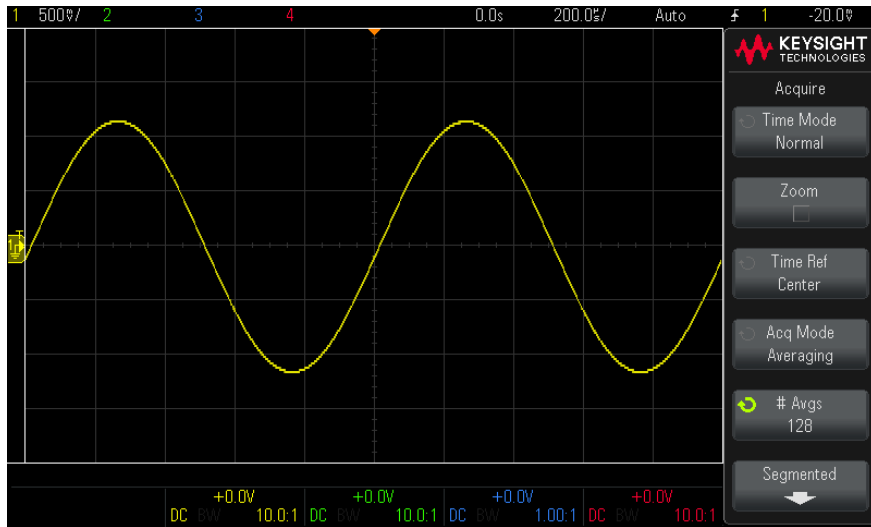
The higher the number of averages, the slower the displayed waveform responds to waveform changes. You must compromise between how quickly the waveform responds to changes and how much you want to reduce the displayed noise on the signal.

To use the Averaging mode:

- 1 Press the **[Acquire]** key, then press the **Acq Mode** softkey until the Averaging mode is selected.
- 2 Press the **#Avg** softkey and turn the Entry knob to set the number of averages that best eliminates the noise from the displayed waveform. The number of acquisitions being averaged is displayed in the **# Avg** softkey.



**Figure 26** Random noise on the displayed waveform



**Figure 27** 128 Averages used to reduce random noise

See Also · [Chapter 12](#), “Trigger Mode/Coupling,” starting on page 121

## High Resolution Acquisition Mode

In High Resolution mode, at slower time/div settings extra samples are averaged in order to reduce random noise, produce a smoother trace on the screen, and effectively increase vertical resolution.

High Resolution mode averages sequential sample points within the same acquisition. An extra bit of vertical resolution is produced for every factor of 2 averages. Random noise is reduced by  $\frac{1}{2}$  for every factor of 4 averages. The number of extra bits of vertical resolution is dependent on the time per division setting (sweep speed) of the oscilloscope.

The slower the time/div setting, the greater the number of samples that are averaged together for each display point.

High Resolution mode can be used on both single-shot and repetitive signals and it does not slow waveform update because the computation is done in the MegaZoom custom ASIC. High Resolution mode limits the oscilloscope's real-time bandwidth because it effectively acts like a low-pass filter.

Sweep speed	Bits of resolution
$\leq 1 \mu\text{s}/\text{div}$	8
$2 \mu\text{s}/\text{div}$	9
$5 \mu\text{s}/\text{div}$	10
$10 \mu\text{s}/\text{div}$	11
$\geq 20 \mu\text{s}/\text{div}$	12

## Acquiring to Segmented Memory

Segmented memory is available on DSOX1200-Series models.

When capturing multiple infrequent trigger events it is advantageous to divide the oscilloscope's memory into segments. This lets you capture signal activity without capturing long periods of signal inactivity.

Each segment is complete with all analog channel and serial decode data.

When using segmented memory, use the Analyze Segments feature (see "[Infinite Persistence with Segmented Memory](#)" on page 142) to show infinite persistence across all acquired segments. See also "[To set or clear persistence](#)" on page 85 for details.

- To acquire to segmented memory
- 1 Set up a trigger condition. (See [Chapter 11](#), "Triggers," starting on page 97 for details.)
  - 2 Press the **[Acquire]** key in the Waveform section of the front panel.
  - 3 Press the **Segmented** softkey.
  - 4 In the Segmented Mem menu, press the **Segmented** softkey to enable segmented memory acquisitions.
  - 5 Press the **# of Segs** softkey and turn the Entry knob to select the number of segments into which you would like to divide the oscilloscope's memory.
 

Memory can be divided into as few as two segments and as many as 500 segments.
  - 6 Press the **[Run]** or **[Single]** key.

The oscilloscope runs and fills a memory segment for each trigger event. When the oscilloscope is busy acquiring multiple segments, the progress is displayed in the upper right area of the display. The oscilloscope continues to trigger until memory is filled, then the oscilloscope stops.

If the signal you are measuring has more than about 1 s of inactivity, consider selecting the **Normal** trigger mode to prevent auto-triggering. See "[To select the Auto or Normal trigger mode](#)" on page 122.

- See Also
- "[Navigating Segments](#)" on page 142
  - "[Infinite Persistence with Segmented Memory](#)" on page 142
  - "[Segmented Memory Re-Arm Time](#)" on page 142
  - "[Saving Data from Segmented Memory](#)" on page 143

## Navigating Segments

- 1 Press the **Current Seg** softkey and turn the Entry knob to display the desired segment along with a time tag indicating the time from the first trigger event.

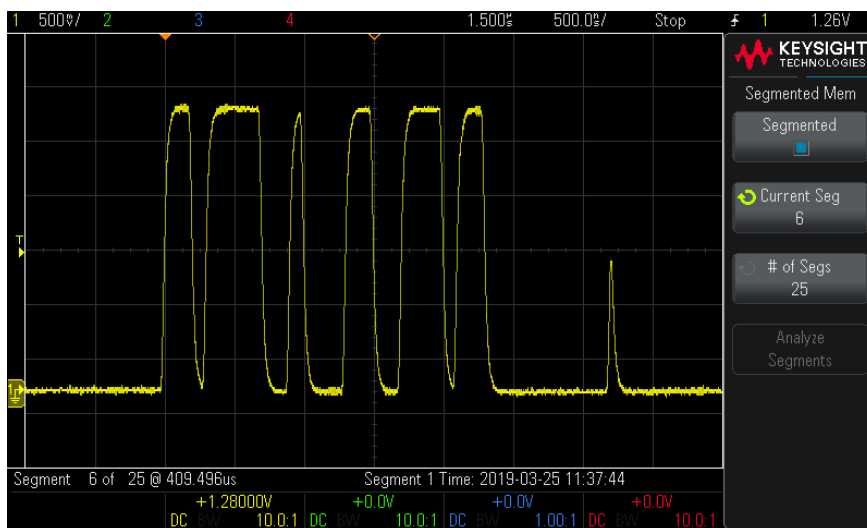
## Infinite Persistence with Segmented Memory

When data has been acquired to segmented memory, you can also turn on infinite persistence (in the Display menu) and press the **Analyze Segments** softkey to create an infinite persistence display. The **Analyze Segments** softkey appears when the acquisition is stopped and the segmented memory feature is on.

## Segmented Memory Re-Arm Time

After each segment fills, the oscilloscope re-arms and is ready to trigger in about 1  $\mu$ s.

Remember though, for example: if the horizontal time per division control is set to 5  $\mu$ s/div, and the Time Reference is set to **Center**, it will take at least 50  $\mu$ s to fill all ten divisions and re-arm. (That is 25  $\mu$ s to capture pre-trigger data and 25  $\mu$ s to capture post-trigger data.)



## Saving Data from Segmented Memory

You can save either the currently displayed segment (**Save Segment - Current**), or all segments (**Save Segment - All**) in the following data formats: CSV, ASCII XY, and BIN.

Be sure to set the Length control to capture enough points to accurately represent the captured data. When the oscilloscope is busy saving multiple segments, progress is displayed in the upper right area of the display.

For more information, see ["To save CSV, ASCII XY, or BIN data files"](#) on page 220.





# 14 Cursors

To make cursor measurements / 146

Cursor Examples / 150

Cursors are horizontal and vertical markers that indicate X-axis values and Y-axis values on a selected waveform source. You can use cursors to make custom voltage, time, phase, or ratio measurements on oscilloscope signals.

Cursor information is displayed in the information area on the bottom of the display.

Cursors are not always limited to the visible display. If you set a cursor, then pan and zoom the waveform until the cursor is off screen, its value will not be changed. It will still be there when you return to its original location.

**X Cursors** X cursors are vertical dashed lines that adjust horizontally and can be used to measure time (s), frequency (1/s), phase ( $^{\circ}$ ), and ratio (%).

The X1 cursor is the short-dashed vertical line, and the X2 cursor is the long-dashed vertical line.

When used with the FFT math function as a source, the X cursors indicate frequency.

In XY horizontal mode, the X cursors display channel 1 values (Volts or Amps).

The X1 and X2 cursor values for the selected waveform source are displayed in the softkey menu area.

The difference between X1 and X2 ( $\Delta X$ ) and  $1/\Delta X$  are displayed in the Cursors box in the bottom information area.

**Y Cursors** Y cursors are horizontal dashed lines that adjust vertically and can be used to measure Volts or Amps, dependent on the channel **Probe Units** setting, or they can measure ratios (%). When math functions are used as a source, the measurement units correspond to that math function.

The Y1 cursor is the short-dashed horizontal line and the Y2 cursor is the long-dashed horizontal line.

The Y cursors adjust vertically and typically indicate values relative to the waveform's ground point, except math FFT where the values are relative to 0 dB.

In XY horizontal mode, the Y cursors display channel 2 values (Volts or Amps).

When active, the Y1 and Y2 cursor values for the selected waveform source are displayed in the softkey menu area.

The difference between Y1 and Y2 ( $\Delta Y$ ) is displayed in the Cursors box in the bottom information area.

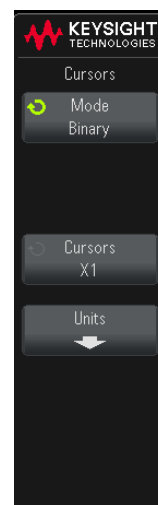
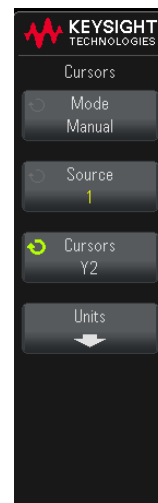
## To make cursor measurements

- 1 Connect a signal to the oscilloscope and obtain a stable display.
- 2 Press the **[Cursors]** key.

The Cursors box in the bottom information area appears, indicating that cursors are "on". (Press the **[Cursors]** key again when you want to turn cursors off.)

- 3 In the Cursors menu, press **Mode**; then, select the desired mode:

- **Manual** –  $\Delta X$ ,  $1/\Delta X$ , and  $\Delta Y$  values are displayed.  $\Delta X$  is the difference between the X1 and X2 cursors and  $\Delta Y$  is the difference between the Y1 and Y2 cursors.
- **Track Waveform** – As you move a marker horizontally, the vertical amplitude of the waveform is tracked and measured. The time and voltage positions are shown for the markers. The vertical (Y) and horizontal (X) differences between the markers are shown as  $\Delta X$  and  $\Delta Y$  values.
- **Binary** – Logic levels of displayed waveforms at the current X1 and X2 cursor positions are displayed in binary. The display is color coded to match the color of the related channel's waveform.



- **Hex** – Logic levels of displayed waveforms at the current X1 and X2 cursor positions are displayed in hexadecimal.

**Manual** and **Track Waveform** modes can be used on waveforms that are displayed on the analog input channels (including math functions).

In **Hex** and **Binary** modes, a level can be displayed as 1 (higher than trigger level), 0 (lower than trigger level), indeterminate state ( $\updownarrow$ ), or X (don't care).

In **Binary** mode, X is displayed if the channel is turned off.

In **Hex** mode, the channel is interpreted as 0 if turned off.

- 4 Press **Source** (or **X1 Source**, **X2 Source** in the **Track Waveform** mode); then, select the input source for cursor values.
- 5 Select the cursor(s) to be adjusted:
  - Push the **Cursors** knob; then, turn the **Cursors** knob. To finalize your selection, either push the **Cursors** knob again or wait about five seconds for the popup menu to disappear.

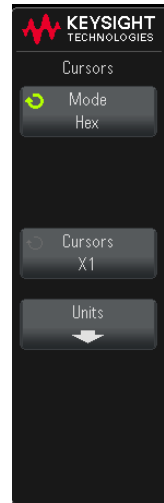
Or:

- Press the **Cursors** softkey; then, turn the **Entry** knob.

The **X1 X2 linked** and **Y1 Y2 linked** selections let you adjust both cursors at the same time, while the delta value remains the same. This can be useful, for example, for checking pulse width variations in a pulse train.

The currently selected cursor(s) display brighter than the other cursors.

- 6 To change the cursor units, press the **Units** softkey.



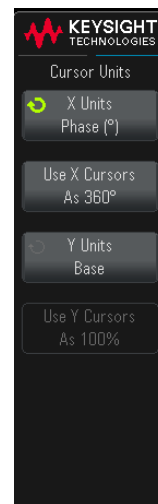
In the Cursor Units menu:

You can press the **X Units** softkey to select:

- **Seconds (s).**
- **Hz (1/s).**
- **Phase (°)** – when selected, use the **Use X Cursors** softkey to set the current X1 location as 0 degrees and the current X2 location as 360 degrees.
- **Ratio (%)** – when selected, use the **Use X Cursors** softkey to set the current X1 location as 0% and the current X2 location as 100%.

You can press the **Y Units** softkey to select:

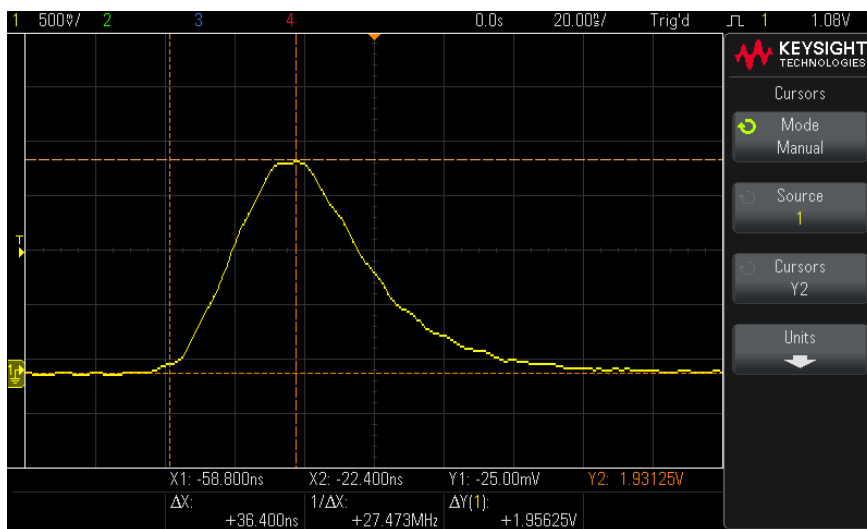
- **Base** – the same units used for the source waveform.
- **Ratio (%)** – when selected, use the **Use Y Cursors** softkey to set the current Y1 location as 0% and the current Y2 location as 100%.



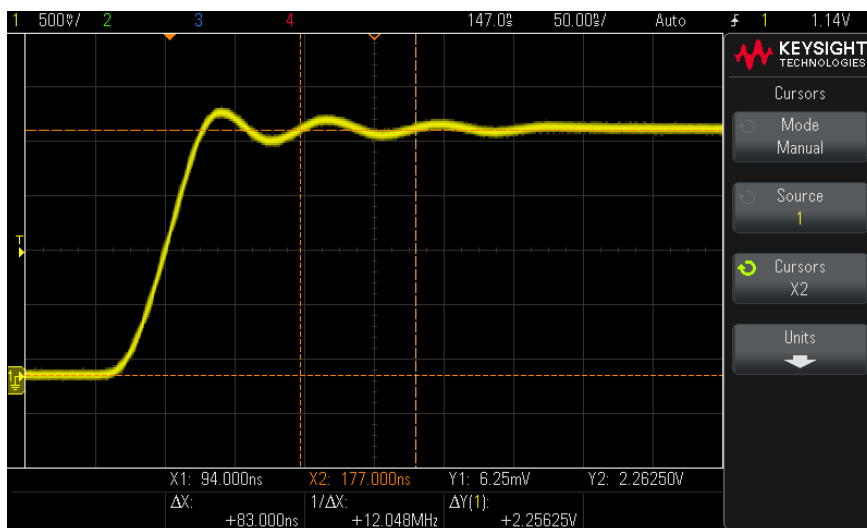
For phase or ratio units, once the 0 and 360 degree or 0 and 100% locations are set, adjusting cursors will display measurements relative to the set locations.

- 7 Adjust the selected cursor(s) by turning the Cursors knob.

## Cursor Examples

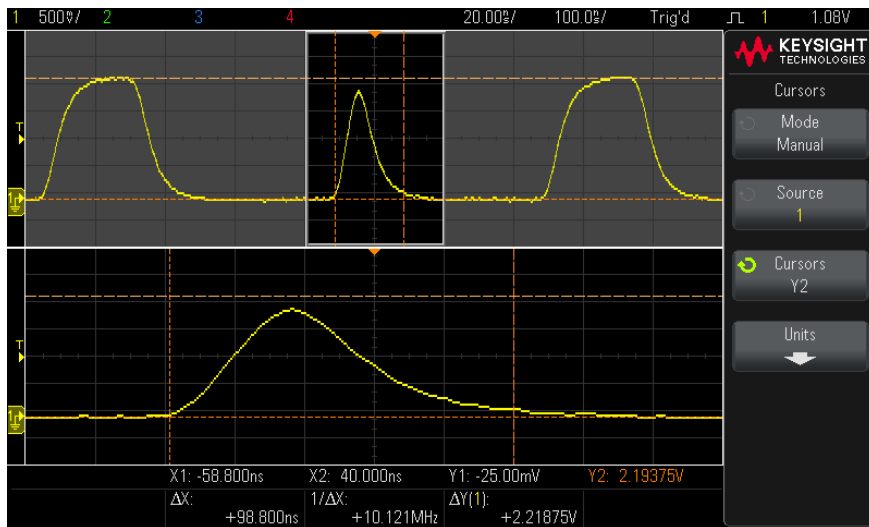


**Figure 28** Cursors used to measure pulse widths other than middle threshold points



**Figure 29** Cursors measure frequency of pulse ringing

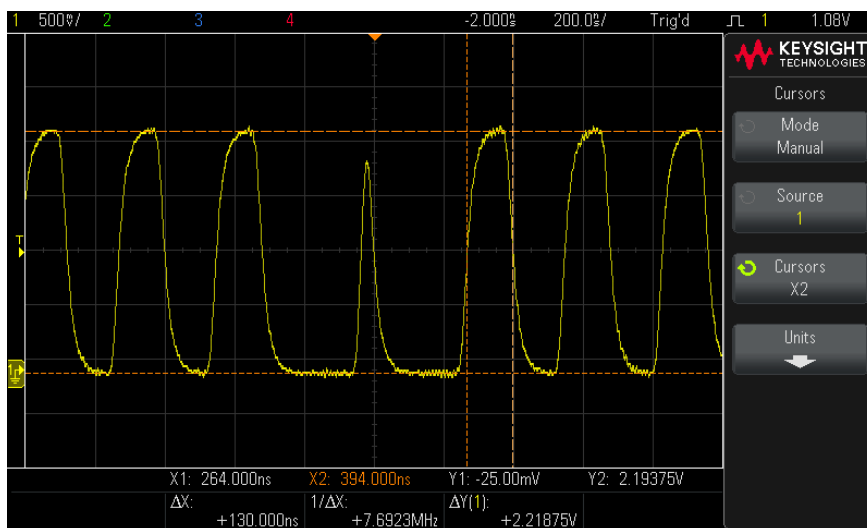
Expand the display with Zoom mode, then characterize the event of interest with the cursors.



**Figure 30** Cursors track Zoom window

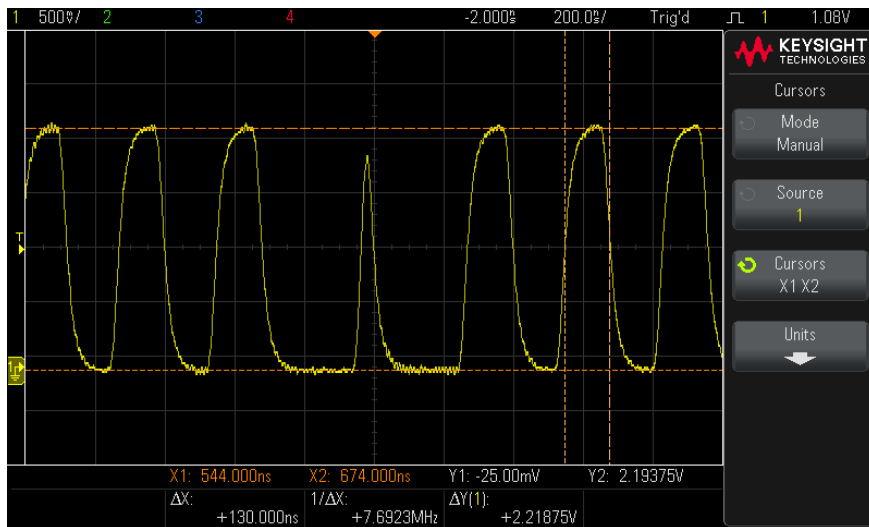
Put the **X1** cursor on one side of a pulse and the **X2** cursor on the other side of the pulse.





**Figure 31** Measuring pulse width with cursors

Press the **X1 X2 linked** softkey and move the cursors together to check for pulse width variations in a pulse train.



**Figure 32** Moving the cursors together to check pulse width variations

# 15 Measurements

- To make automatic measurements / 156
- Measurements Summary / 157
- Voltage Measurements / 160
- Time Measurements / 167
- Count Measurements / 174
- Measurement Thresholds / 175
- Measurement Window with Zoom Display / 177
- Measurement Statistics / 178

The **[Meas]** key lets you make automatic measurements on waveforms. Some measurements can only be made on analog input channels.

The results of the last four selected measurements are displayed in the Measurements information area at the bottom of the screen.

Cursors are turned on to show the portion of the waveform being measured for the most recently added measurement.

## NOTE

### Post Acquisition Processing

In addition to changing display parameters after the acquisition, you can perform all of the measurements and math functions after the acquisition. Measurements and math functions will be recalculated as you pan and zoom and turn channels on and off. As you zoom in and out on a signal using the horizontal scale knob and vertical volts/division knob, you affect the resolution of the display. Because measurements and math functions are performed on displayed data, you affect the resolution of functions and measurements.

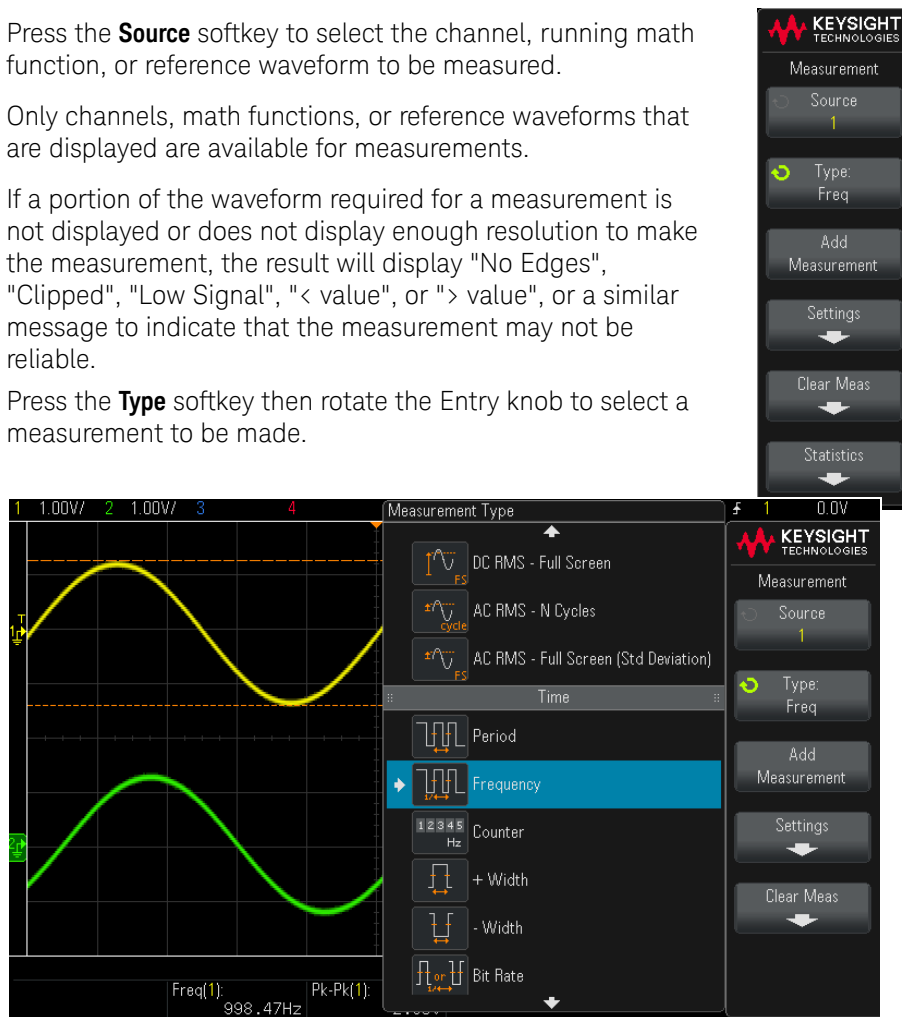
## To make automatic measurements

- 1 Press the **[Meas]** key to display the Measurement menu.
- 2 Press the **Source** softkey to select the channel, running math function, or reference waveform to be measured.

Only channels, math functions, or reference waveforms that are displayed are available for measurements.

If a portion of the waveform required for a measurement is not displayed or does not display enough resolution to make the measurement, the result will display "No Edges", "Clipped", "Low Signal", "< value", or "> value", or a similar message to indicate that the measurement may not be reliable.

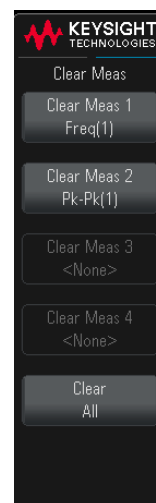
- 3 Press the **Type** softkey then rotate the Entry knob to select a measurement to be made.



For more information on the types of measurements, see "[Measurements Summary](#)" on page 157.

- 4 The **Settings** softkey will be available to make additional measurement settings on some measurements.
- 5 Press the **Add Measurement** softkey or push the Entry knob to display the measurement.
- 6 To turn off measurements, press the **[Meas]** key again.  
Measurements are erased from the display.
- 7 To stop making one or more measurements, press the **Clear Meas** softkey and choose the measurement to clear, or press **Clear All**.

After all measurements have been cleared, when **[Meas]** is pressed again, the default measurements will be Frequency and Peak-Peak.



## Measurements Summary

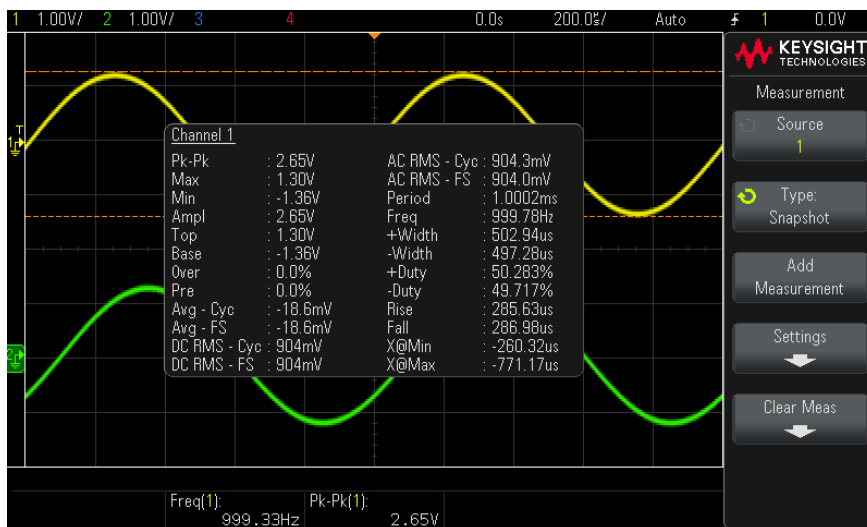
The automatic measurements provided by the oscilloscope are listed in the following table. All measurements are available for analog channel waveforms. All measurements except Counter are available for math waveforms other than FFT. A limited set of measurements is available for math FFT waveforms (as described in the following table).

Measurement	Valid for Math FFT*	Notes
"Snapshot All" on page 159		
"Amplitude" on page 161		
"Average" on page 164	Yes, Full Screen	
"Base" on page 162		
"Bit Rate" on page 169		
"Counter" on page 169		Not valid for math waveforms.
"Delay" on page 170		Measures between two sources. Press <b>Settings</b> to specify the second source.
"Duty Cycle" on page 170		
"Fall Time" on page 170		
"Frequency" on page 168		
"Maximum" on page 160	Yes	
"Minimum" on page 161	Yes	
"Rising Edge Count" on page 175		
"Falling Edges Count" on page 175		
"Positive Pulse Count" on page 174		
"Negative Pulse Count" on page 174		
"Overshoot" on page 162		
"Peak-Peak" on page 160	Yes	
"Period" on page 167		
"Phase" on page 171		Measures between two sources. Press <b>Settings</b> to specify the second source.
"Preshoot" on page 163		
"Rise Time" on page 170		

Measurement	Valid for Math FFT*	Notes
"DC RMS" on page 164		
"AC RMS" on page 165		
"Top" on page 161		
"+ Width" on page 169		
"- Width" on page 169		
"X at Max Y" on page 173	Yes	The resultant units are in Hertz.
"X at Min Y" on page 173	Yes	The resultant units are in Hertz.
* Use the cursors to make other measurements on FFT.		

## Snapshot All

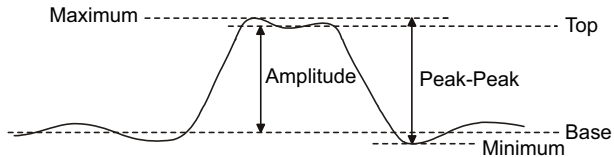
The Snapshot All measurement type displays a popup containing a snapshot of all the single waveform measurements.



You can also configure the **[Quick Action]** key to display the Snapshot All popup. See **"Configuring the [Quick Action] Key"** on page 248.

## Voltage Measurements

The following figure shows the voltage measurement points.



Measurement units for each input channel can be set to Volts or Amps using the channel **Probe Units** softkey. See ["To specify the channel units"](#) on page 52.

The units of math waveforms are described in ["Units for Math Waveforms"](#) on page 67.

- ["Peak-Peak"](#) on page 160
- ["Maximum"](#) on page 160
- ["Minimum"](#) on page 161
- ["Amplitude"](#) on page 161
- ["Top"](#) on page 161
- ["Base"](#) on page 162
- ["Overshoot"](#) on page 162
- ["Preshoot"](#) on page 163
- ["Average"](#) on page 164
- ["DC RMS"](#) on page 164
- ["AC RMS"](#) on page 165

### Peak-Peak

The peak-to-peak value is the difference between Maximum and Minimum values. The Y cursors show the values being measured.

### Maximum

Maximum is the highest value in the waveform display. The Y cursor shows the value being measured.



## Minimum

Minimum is the lowest value in the waveform display. The Y cursor shows the value being measured.

## Amplitude

The Amplitude of a waveform is the difference between its Top and Base values. The Y cursors show the values being measured.

## Top

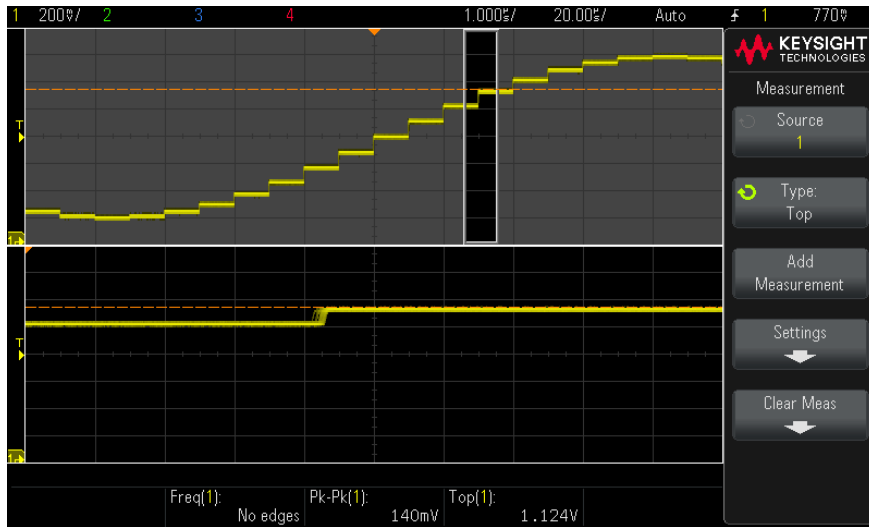
The Top of a waveform is the mode (most common value) of the upper part of the waveform, or if the mode is not well defined, the top is the same as Maximum. The Y cursor shows the value being measured.

**See Also** · ["To isolate a pulse for Top measurement"](#) on page 161

### **To isolate a pulse for Top measurement**

The following figure shows how to use Zoom mode to isolate a pulse for a **Top** measurement.

You may need to change the measurement window setting so that the measurement is made in the lower, Zoom window. See ["Measurement Window with Zoom Display"](#) on page 177.



**Figure 33** Isolating area for Top measurement

## Base

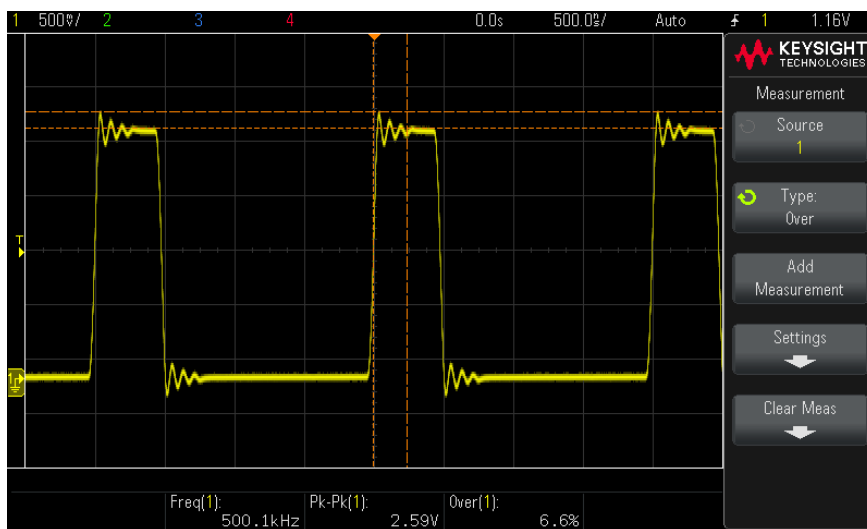
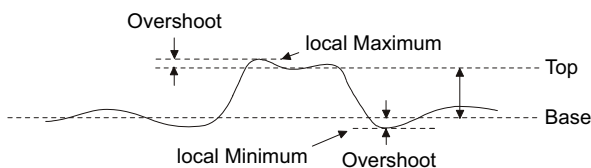
The Base of a waveform is the mode (most common value) of the lower part of the waveform, or if the mode is not well defined, the base is the same as Minimum. The Y cursor shows the value being measured.

## Overshoot

Overshoot is distortion that follows a major edge transition expressed as a percentage of Amplitude. The X cursors show which edge is being measured (edge closest to the trigger reference point).

$$\text{Rising edge overshoot} = \frac{\text{local Maximum} - \text{D Top}}{\text{Amplitude}} \times 100$$

$$\text{Falling edge overshoot} = \frac{\text{Base} - \text{D local Minimum}}{\text{Amplitude}} \times 100$$



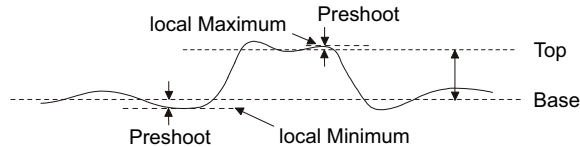
**Figure 34** Automatic Overshoot measurement

## Preshoot

Preshoot is distortion that precedes a major edge transition expressed as a percentage of Amplitude. The X cursors show which edge is being measured (edge closest to the trigger reference point).

$$\text{Rising edge preshoot} = \frac{\text{local Maximum} - D \text{ Top}}{\text{Amplitude}} \times 100$$

$$\text{Falling edge preshoot} = \frac{\text{Base} - \text{D local Minimum}}{\text{Amplitude}} \times 100$$



## Average

Average is the sum of the levels of the waveform samples divided by the number of samples.

$$\text{Average} = \frac{\sum x_i}{n}$$

Where  $x_i$  = value at  $i$ th point being measured,  $n$  = number of points in measurement interval.

The Full Screen measurement interval variation measures the value on all displayed data points.

The N Cycles measurement interval variation measures the value on an integral number of periods of the displayed signal. If less than three edges are present, the measurement shows "No edges".

The X cursors show what interval of the waveform is being measured.

## DC RMS

DC RMS is the root-mean-square value of the waveform over one or more full periods.

$$\text{RMS (dc)} = \sqrt{\frac{\sum_{i=1}^n x_i^2}{n}}$$

Where  $x_i$  = value at  $i$ th point being measured,  $n$  = number of points in measurement interval.

The Full Screen measurement interval variation measures the value on all displayed data points.

The N Cycles measurement interval variation measures the value on an integral number of periods of the displayed signal. If less than three edges are present, the measurement shows "No edges".

The X cursors show the interval of the waveform being measured.

## AC RMS

AC RMS is the root-mean-square value of the waveform, with the DC component removed. It is useful, for example, for measuring power supply noise.

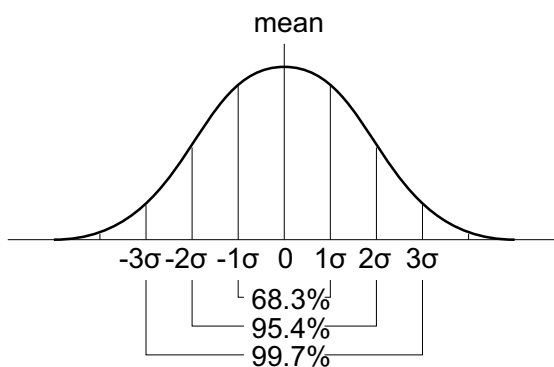
The N Cycles measurement interval measures the value on an integral number of periods of the displayed signal. If less than three edges are present, the measurement shows "No edges".

The X cursors show the interval of the waveform being measured.

The Full Screen (Std Deviation) measurement interval variation is an RMS measurement across the full screen with the DC component removed. It shows the standard deviation of the displayed voltage values.

The standard deviation of a measurement is the amount that a measurement varies from the mean value. The Mean value of a measurement is the statistical average of the measurement.

The following figure graphically shows the mean and standard deviation. Standard deviation is represented by the Greek letter sigma:  $\sigma$ . For a Gaussian distribution, two sigma ( $\pm 1\sigma$ ) from the mean, is where 68.3 percent of the measurement results reside. Six sigma ( $\pm 3\sigma$ ) from is where 99.7 percent of the measurement results reside.



The mean is calculated as follows:

$$\bar{x} = \frac{\sum_{i=1}^N x_i}{N}$$

where:

- $x$  = the mean.
- $N$  = the number of measurements taken.
- $x_i$  = the  $i$ th measurement result.

The standard deviation is calculated as follows:

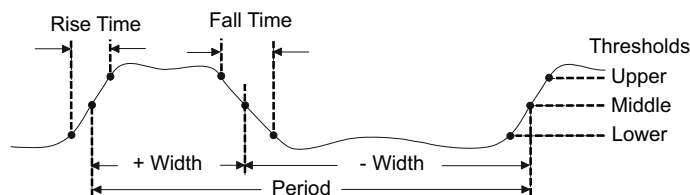
$$\sigma = \sqrt{\frac{\sum_{i=1}^N (x_i - \bar{x})^2}{N}}$$

where:

- $\sigma$  = the standard deviation.
- $N$  = the number of measurements taken.
- $x_i$  = the  $i$ th measurement result.
- $x$  = the mean.

## Time Measurements

The following figure shows time measurement points.



The default lower, middle, and upper measurement thresholds are 10%, 50%, and 90% between Top and Base values. See **"Measurement Thresholds"** on page 175 for other percentage threshold and absolute value threshold settings.

- **"Period"** on page 167
- **"Frequency"** on page 168
- **"Counter"** on page 169
- **" + Width"** on page 169
- **" - Width"** on page 169
- **"Bit Rate"** on page 169
- **"Duty Cycle"** on page 170
- **"Rise Time"** on page 170
- **"Fall Time"** on page 170
- **"Delay"** on page 170
- **"Phase"** on page 171
- **"X at Min Y"** on page 173
- **"X at Max Y"** on page 173

### Period

Period is the time period of the complete waveform cycle. The time is measured between the middle threshold points of two consecutive, like-polarity edges. A middle threshold crossing must also travel through the lower and upper threshold levels which eliminates runt pulses. The X cursors show what portion of the waveform is being measured. The Y cursor shows the middle threshold point.

## Frequency

Frequency is defined as  $1/\text{Period}$ . Period is defined as the time between the middle threshold crossings of two consecutive, like-polarity edges. A middle threshold crossing must also travel through the lower and upper threshold levels which eliminates runt pulses. The X cursors show what portion of the waveform is being measured. The Y cursor shows the middle threshold point.

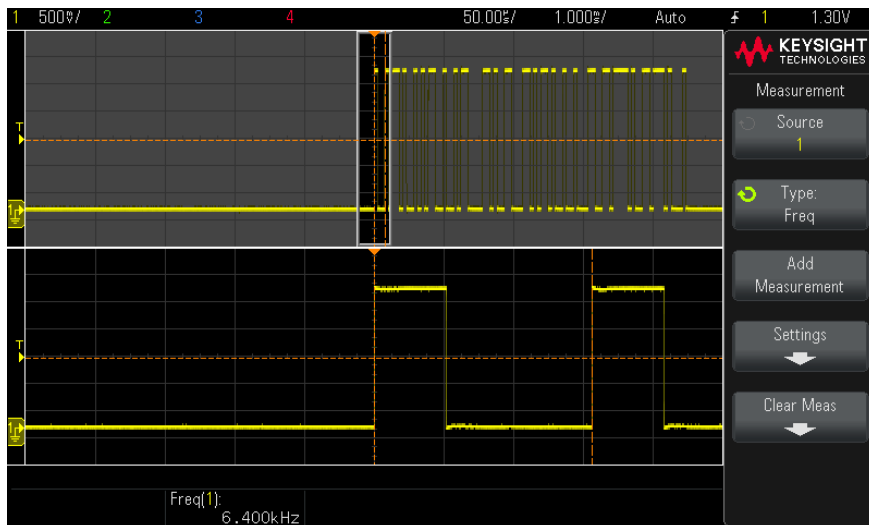
See Also · ["To isolate an event for frequency measurement"](#) on page 168

### To isolate an event for frequency measurement

The following figure shows how to use Zoom mode to isolate an event for a frequency measurement.

You may need to change the measurement window setting so that the measurement is made in the lower, Zoom window. See ["Measurement Window with Zoom Display"](#) on page 177.

If the waveform is clipped, it may not be possible to make the measurement.



**Figure 35** Isolating an event for Frequency measurement



## Counter

The InfiniiVision 1200 X-Series oscilloscopes have an integrated hardware frequency counter which counts the number of cycles that occur within a period of time (known as the gate time) to measure the frequency of a signal.

The gate time for the Counter measurement is automatically adjusted to be 100 ms or twice the current time window, whichever is longer, up to 1 second.

The Counter can measure frequencies up to the bandwidth of the oscilloscope. The minimum frequency supported is  $1/(2 \times \text{gate time})$ .

The hardware counter uses the trigger comparator output. Therefore, the counted channel's trigger level (or threshold for digital channels) must be set correctly. The Y cursor shows the threshold level used in the measurement.

Analog and Ext Trig channels can be selected as the source. On 4-channel oscilloscope models, you must set up an edge trigger on the EXT TRIG input before it can be selected as the counter source.

Only one Counter measurement can be displayed at a time.

### + Width

**+ Width** is the time from the middle threshold of the rising edge to the middle threshold of the next falling edge. The X cursors show the pulse being measured. The Y cursor shows the middle threshold point.

### – Width

**– Width** is the time from the middle threshold of the falling edge to the middle threshold of the next rising edge. The X cursors show the pulse being measured. The Y cursor shows the middle threshold point.

## Bit Rate

The bit rate measurement measures all positive and negative pulse widths on the waveform, takes the minimum value found of either width type and inverts that minimum width to give a value in Hertz.

## Duty Cycle

The duty cycle of a repetitive pulse train is the ratio of the positive pulse width to the period, expressed as a percentage. The X cursors show the time period being measured. The Y cursor shows the middle threshold point.

$$+ \text{ Duty cycle} = \frac{+ \text{ Width}}{\text{Period}} \times 100 \quad - \text{ Duty cycle} = \frac{- \text{ Width}}{\text{Period}} \times 100$$

## Rise Time

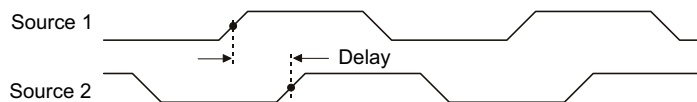
The rise time of a signal is the time difference between the crossing of the lower threshold and the crossing of the upper threshold for a positive-going edge. The X cursor shows the edge being measured. For maximum measurement accuracy, set the horizontal time/div as fast as possible while leaving the complete rising edge of the waveform on the display. The Y cursors show the lower and upper threshold points.

## Fall Time

The fall time of a signal is the time difference between the crossing of the upper threshold and the crossing of the lower threshold for a negative-going edge. The X cursor shows the edge being measured. For maximum measurement accuracy, set the horizontal time/div as fast as possible while leaving the complete falling edge of the waveform on the display. The Y cursors show the lower and upper threshold points.

## Delay

Delay measures the time difference from the selected edge on source 1 and the selected edge on source 2 closest to the timebase reference point at the middle threshold points on the waveforms. Negative delay values indicate that the selected edge of source 1 occurred after the selected edge of source 2.



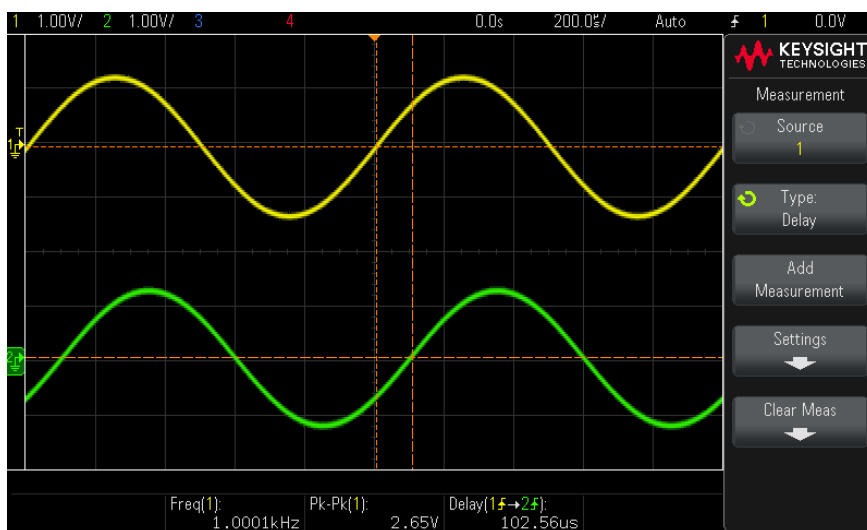
- 1 Press the **[Meas]** key to display the Measurement menu.

- 2 Press the **Source** softkey; then turn the Entry knob to select the first analog channel source.
- 3 Press the **Type:** softkey; then, turn the Entry knob to select **Delay**.
- 4 Press the **Settings** softkey to select the second analog channel source and slope for the delay measurement.

The default Delay settings measure from the rising edge of channel 1 to the rising edge of channel 2.

- 5 Press the **Back** key to return to the Measurement menu.
- 6 Press the **Add Measurement** softkey to make the measurement.

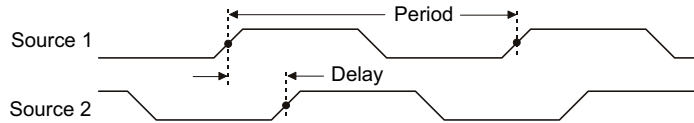
The example below shows a delay measurement between the rising edge of channel 1 and the rising edge of channel 2.



## Phase

Phase is the calculated phase shift from source 1 to source 2, expressed in degrees. Negative phase shift values indicate that the rising edge of source 1 occurred after the rising edge of source 2.

$$\text{Phase} = \frac{\text{Delay}}{\text{Source 1 Period}} \times 360$$

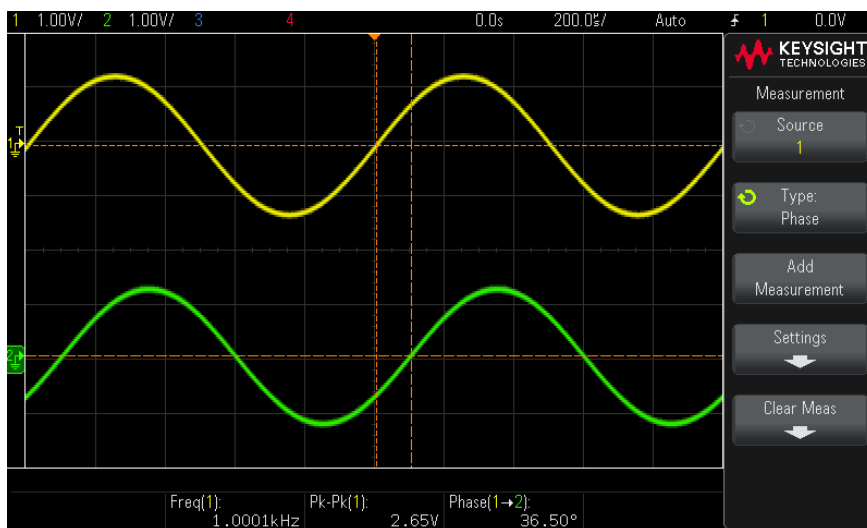


- 1 Press the **[Meas]** key to display the Measurement menu.
- 2 Press the **Source** softkey; then turn the Entry knob to select the first analog channel source.
- 3 Press the **Type:** softkey; then, turn the Entry knob to select **Delay**.
- 4 Press the **Settings** softkey to select the second analog channel source for the phase measurement.

The default Phase settings measure from channel 1 to channel 2.

- 5 Press the **⏪** Back key to return to the Measurement menu.
- 6 Press the **Add Measurement** softkey to make the measurement.

The example below shows a phase measurement between the channel 1 and the math d/dt function on channel 1.



## X at Min Y

X at Min Y is the X axis value (usually time) at the first displayed occurrence of the waveform Minimum, starting from the left-side of the display. For periodic signals, the position of the minimum may vary throughout the waveform. The X cursor shows where the current X at Min Y value is being measured.

## X at Max Y

X at Max Y is the X axis value (usually time) at the first displayed occurrence of the waveform Maximum, starting from the left-side of the display. For periodic signals, the position of the maximum may vary throughout the waveform. The X cursor shows where the current X at Max Y value is being measured.

See Also · ["To measure the peak of an FFT" on page 173](#)

### To measure the peak of an FFT

- 1 Select **FFT** as the Operator in the Waveform Math Menu.
- 2 Choose **Math: f(t)** as the source in the Measurement Menu.
- 3 Choose **Maximum** and **X at Max Y** measurements.

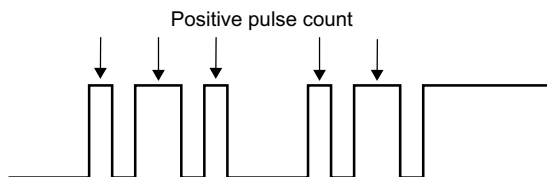
**Maximum** units are in dB and **X at Max Y** units are in Hertz for FFT.

## Count Measurements

- **"Positive Pulse Count"** on page 174
- **"Negative Pulse Count"** on page 174
- **"Rising Edge Count"** on page 175
- **"Falling Edges Count"** on page 175

### Positive Pulse Count

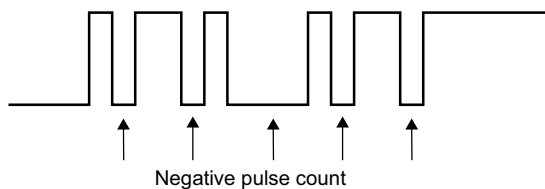
The **Positive Pulse Count** measurement is a pulse count for the selected waveform source.



This measurement is available for analog channels.

### Negative Pulse Count

The **Negative Pulse Count** measurement is a pulse count for the selected waveform source.



This measurement is available for analog channels.

## Rising Edge Count

The **Rising Edge Count** measurement is an edge count for the selected waveform source.

This measurement is available for analog channels.

## Falling Edges Count

The **Falling Edges Count** measurement is an edge count for the selected waveform source.

This measurement is available for analog channels.

## Measurement Thresholds

Setting measurement thresholds defines the vertical levels where measurements will be taken on an analog channel or math waveform.

### NOTE

#### Changing default thresholds may change measurement results

The default lower, middle, and upper threshold values are 10%, 50%, and 90% of the value between Top and Base. Changing these threshold definitions from the default values may change the returned measurement results for Average, Delay, Duty Cycle, Fall Time, Frequency, Overshoot, Period, Phase, Preshoot, Rise Time, +Width, and -Width.

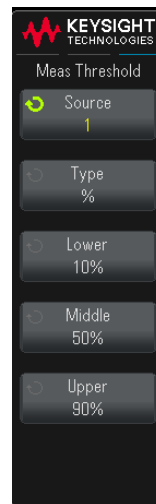
- 1 From the Measurement menu, press the **Settings** softkey; then, press the **Thresholds** softkey to set analog channel measurement thresholds.

You can also open the Meas Threshold menu by pressing **[Analyze] > Features** and then selecting **Measurement Thresholds**.

- 2 Press the **Source** softkey to select the analog channel or math waveform source for which you want to change measurement thresholds.

Each analog channel and the math waveform can be assigned unique threshold values.

- 3 Press the **Type** softkey to set the measurement threshold to **%** (percentage of Top and Base value) or to **Absolute** (absolute value).
  - Percentage thresholds can be set from 5% to 95%.
  - The units for absolute threshold for each channel is set in the channel probe menu.
  - When the **Source** is set to **Math: f(t)**, the threshold **Type** can only be set to **Percent**.



## TIP

### Absolute threshold hints

- Absolute thresholds are dependent on channel scaling, probe attenuation, and probe units. Always set these values first before setting absolute thresholds.
- The minimum and maximum threshold values are limited to on-screen values.
- If any of the absolute threshold values are above or below the minimum or maximum waveform values, the measurement may not be valid.

- 4 Press the **Lower** softkey; then, turn the Entry knob to set the lower measurement threshold value.

Increasing the lower value beyond the set middle value will automatically increase the middle value to be more than the lower value. The default lower threshold is 10% (or 800 mV when absolute thresholds are selected).

If threshold **Type** is set to **%**, the lower threshold value can be set from 5% to 93%.



- 5 Press the **Middle** softkey; then, turn the Entry knob to set the middle measurement threshold value.

The middle value is bounded by the values set for lower and upper thresholds. The default middle threshold is 50% (or 1.20 V when absolute thresholds are selected).

- If threshold **Type** is set to **%**, the middle threshold value can be set from 6% to 94%.

- 6 Press the **Upper** softkey; then, turn the Entry knob to set the upper measurement threshold value.

Decreasing the upper value below the set middle value will automatically decrease the middle value to be less than the upper value. The default upper threshold is 90% (or 1.50 V when absolute thresholds are selected).

- If threshold **Type** is set to **%**, the upper threshold value can be set from 7% to 95%.

## Measurement Window with Zoom Display

When the zoomed time base is displayed, you can choose whether measurements are made in the Main window portion of the display or the Zoom window portion of the display.

- 1 Press the **[Meas]** key.
- 2 In the Measurement menu, press the **Settings** softkey.
- 3 In the Meas Settings menu, press the **Meas Window** softkey; then, turn the Entry knob to select from:
  - **Auto Select** – The measurement is attempted in the lower, Zoom window; if it cannot be made there, the upper, Main window is used.
  - **Main** – The measurement window is the upper, Main window.
  - **Zoom** – The measurement window is the lower, Zoom window.

## Measurement Statistics

Press the **[Meas]** key to enter the Measurement Menu. By default, statistics are displayed, and frequency and voltage are measured on channel 1.

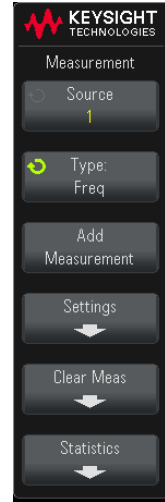
Select the measurements you desire for the channels you are using (see "**Measurements Summary**" on page 157).

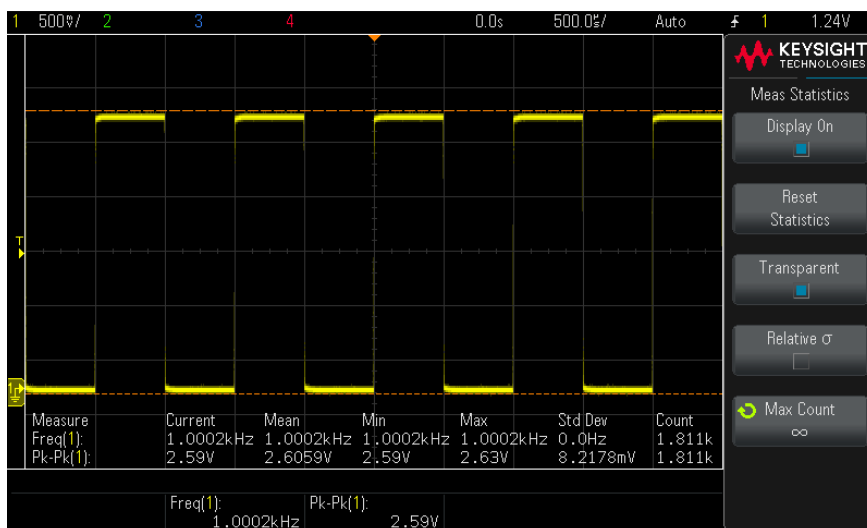
From the Measurement Menu, press the **Statistics** softkey to enter the Statistics Menu.

The following statistics are shown: Name of the measurement, current measured value, mean, minimum measured value, maximum measured value, standard deviation, and the number of times the measurement has been made (count). Statistics are based on the total number of captured waveforms (count).

The standard deviation shown in Statistics is calculated using the same formula used for calculating the standard deviation measurement. The formula is shown in the section titled "**AC RMS**" on page 165.

The source channel of the measurement is shown in parenthesis after the measurement name. For example: "**Freq(1)**" indicates a frequency measurement on channel 1.





You can switch the statistics **Display On** or **Display Off**. Statistics continue to accumulate even when the statistics display is off.

To reset the statistics measurements, press the **Reset Statistics** softkey. This resets all statistics and begins recording statistical data again.

Each time a new measurement (for example: frequency, period, or amplitude) is added the statistics are reset and accumulation of statistical data begins again.

When the **[Single]** key is pressed, statistics are reset and a single measurement is done (count = 1). Successive **[Single]** acquisitions accumulate statistical data (and the count is incremented).

Press the **Transparent** softkey to disable the Transparent mode. This shows statistics with a gray background. Press the **Transparent** softkey again to enable Transparent mode. This writes measurement values, statistics, and cursor values on the screen without a background. The Transparent setting affects measurement statistics, reference waveform information, and the optional Mask test feature's statistics display.

**Relative  $\sigma$**  – When enabled, the standard deviation shown in measurement statistics becomes a relative standard deviation, that is, standard deviation/mean.

**Max Count** – This softkey specifies the number of values used when calculating measurement statistics.

The **Increment Statistics** softkey only appears when the acquisition is stopped and the optional segmented memory feature is off. Press the **[Single]** or **[Run/Stop]** key to stop the acquisition. You can use the horizontal position control (in the Horizontal control section of the front panel) to pan through the waveform. Active measurements will stay on screen, allowing you to measure various aspects of the captured waveforms. Press **Increment Statistics** to add the currently measured waveform to the collected statistical data.

The **Analyze Segments** softkey only appears when the acquisition is stopped and the optional segmented memory feature is on. After an acquisition has completed (and the oscilloscope is stopped), you can press the **Analyze Segments** softkey to accumulate measurement statistics for the acquired segments.

You can also turn on infinite persistence (in the Display Menu) and press the **Analyze Segments** softkey to create an infinite persistence display.

# 16 Mask Testing

To create a mask from a "golden" waveform (Automask) / 181

Mask Test Setup Options / 184

Mask Statistics / 186

To manually modify a mask file / 187

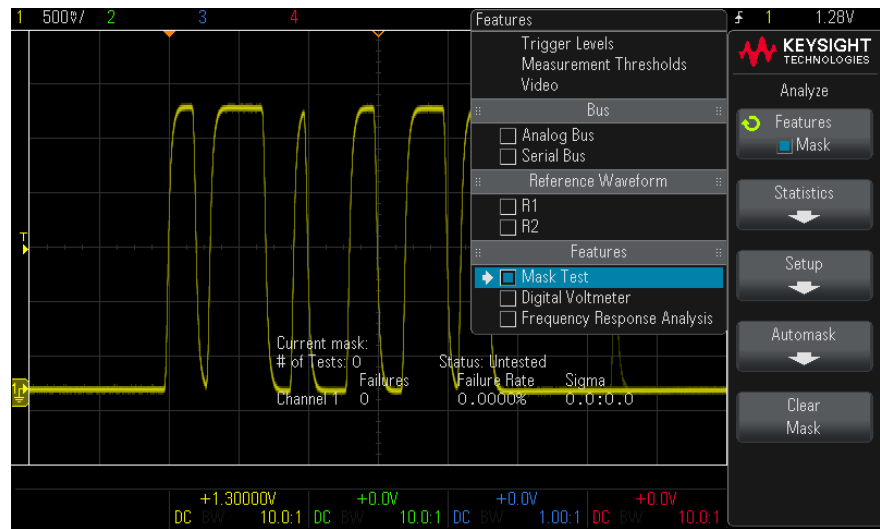
Building a Mask File / 190

On DSOX1200-Series oscilloscopes, one way to verify a waveform's compliance to a particular set of parameters is to use mask testing. A mask defines a region of the oscilloscope's display in which the waveform must remain in order to comply with chosen parameters. Compliance to the mask is verified point-by-point across the display. Mask test operates on displayed analog channels; it does not operate on channels that are not displayed.

## To create a mask from a "golden" waveform (Automask)

A golden waveform meets all chosen parameters, and it is the waveform to which all others will be compared.

- 1 Configure the oscilloscope to display the golden waveform.
- 2 Press the **[Analyze]** key.
- 3 Press **Features**; then, select **Mask Test**.
- 4 Press **Features** again to enable mask testing.

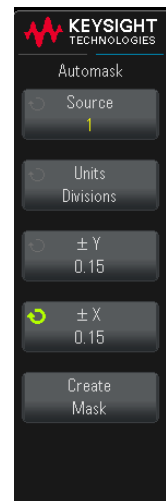


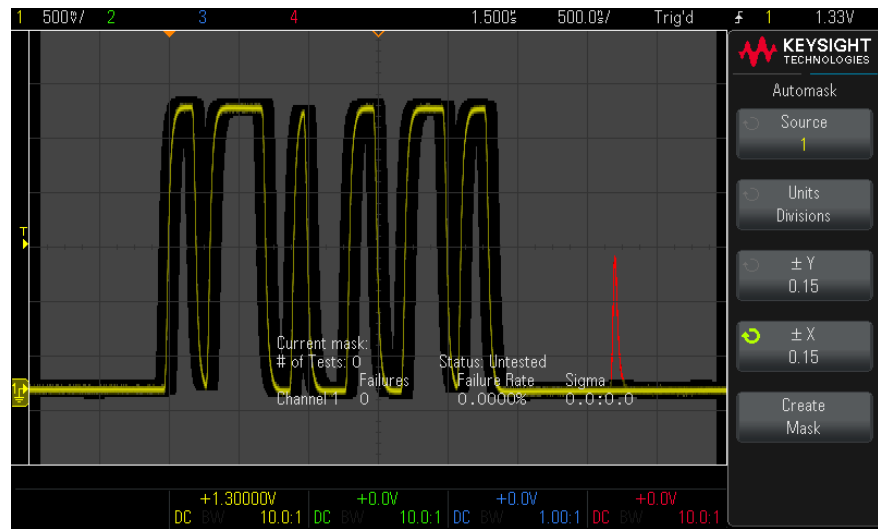
5 Press **Automask**.


- 6 In the Automask menu, press the **Source** softkey and ensure the desired analog channel is selected.
- 7 Adjust the mask's horizontal tolerance ( $\pm Y$ ) and vertical tolerance ( $\pm X$ ). These are adjustable in graticule divisions or in absolute units (volts or seconds), selectable using the **Units** softkey.
- 8 Press the **Create Mask** softkey.

The mask is created and testing begins.

Whenever the **Create Mask** softkey is pressed the old mask is erased and a new mask is created.





- 9 To clear the mask and switch off mask testing, press the  Back key to return to the Analyze menu, then press the **Clear Mask** softkey.

If infinite persistence display mode (see "**To set or clear persistence**" on page 85) is "on" when mask test is enabled, it stays on. If infinite persistence is "off" when mask test is enabled, it is switched on when mask test is switched on, then infinite persistence is switched off when mask test is switched off.

#### Troubleshooting Mask Setup

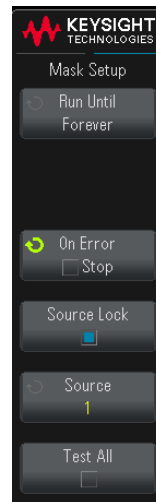
If you press **Create Mask** and the mask appears to cover the entire screen, check the  $\pm Y$  and  $\pm X$  settings in the Automask menu. If these are set to zero the resulting mask will be extremely tight around the waveform.

If you press **Create Mask** and it appears that no mask was created, check the  $\pm Y$  and  $\pm X$  settings. They may be set so large that the mask is not visible.

## Mask Test Setup Options

From the Mask Test menu, press the **Setup** softkey to enter the Mask Setup menu.

- **Run Until** – Lets you specify a condition on which to terminate testing.
  - **Forever** – The oscilloscope runs continuously. However, if an error occurs the action specified using the **On Error** softkey will occur.
  - **Minimum # of Tests** – Choose this option and then use the **# of Tests** softkey to select the number of times the oscilloscope will trigger, display the waveform(s), and compare them to the mask. The oscilloscope will stop after the specified number of tests have been completed. The specified minimum number of tests may be exceeded. If an error occurs the action specified using the **On Error** softkey will occur. The actual number of tests completed is displayed.
  - **Minimum Time** – Choose this option and then use the **Test Time** softkey to select how long the oscilloscope will run. When the selected time has passed the oscilloscope will stop. The specified time may be exceeded. If an error occurs the action specified using the **On Error** softkey will occur. The actual test time is displayed.
  - **Minimum Sigma** – Choose this option and then use the **Sigma** softkey to select a minimum sigma. The mask test runs until enough waveforms are tested to achieve a minimum test sigma. (If an error occurs the oscilloscope will perform the action specified by the **On Error** softkey.) Note that this is a test sigma (the max achievable process sigma, assuming no defects, for a certain number of tested waveforms) as opposed to a process sigma (which is tied to the amount of failures per test). The sigma value may exceed the selected value when a small sigma value is chosen. The actual sigma is displayed.
- **On Error** – Specifies the action(s) to take when the input waveform does not conform to the mask. This setting supersedes the **Run Until** setting.
  - **Stop** – The oscilloscope will stop when the first error is detected (on the first waveform that does not conform to the mask). This setting supersedes the **Minimum # of Tests** and **Minimum Time** settings.





- **Save** – The oscilloscope saves the screen image when an error is detected. In the Save menu (press **[Save/Recall] > Save**), select an image format (\*.bmp or \*.png), destination (on a USB storage device), and file name (which can be auto-incrementing). If errors occur too frequently and the oscilloscope spends all its time saving images, press the **[Stop]** key to stop acquisitions.
- **Print** – The oscilloscope prints the screen image when an error is detected. This option is only available when a printer is connected as described in "**To print the oscilloscope's display**" on page 229.
- **Measure** – Measurements (and measurement statistics if your oscilloscope supports them) run only on waveforms that contain a mask violation. Measurements are not affected by passing waveforms. This mode is not available when the acquisition mode is set to Averaging.

Note that you can choose to **Print** or **Save**, but you cannot select both at the same time. All other actions may be selected at the same time. For example, you can select both **Stop** and **Measure** to cause the oscilloscope to measure and stop on the first error..

On G-suffix oscilloscope models (that have a built-in waveform generator), you can output a signal on the front panel Gen Out connector when there is a mask test failure. See "**Setting the Gen Out Source**" on page 242.

- **Source Lock** – When you turn on Source Lock using the **Source Lock** softkey, the mask is redrawn to match the source whenever you move the waveform. For example, if you change the horizontal timebase or the vertical gain the mask is redrawn with the new settings.

When you turn off Source Lock, the mask is not redrawn when horizontal or vertical settings are changed.

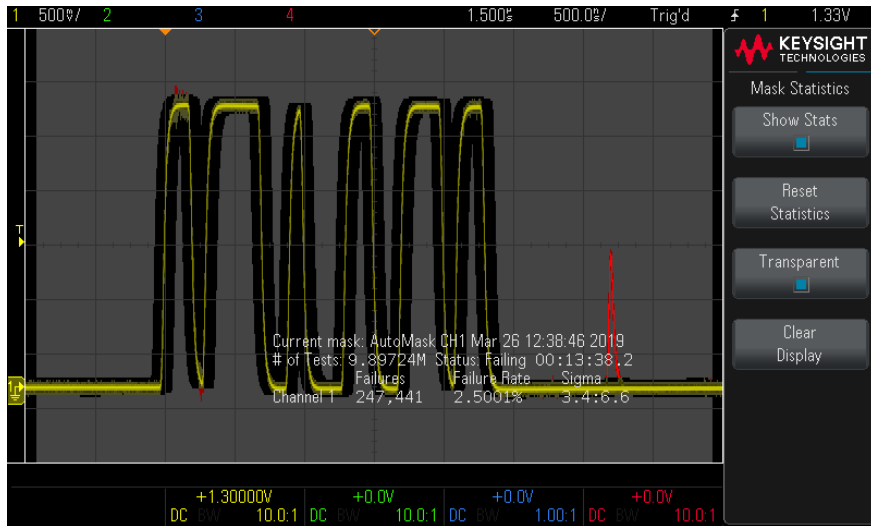
- **Source** – If you change the Source channel, the mask is not erased. It is re-scaled to the vertical gain and offset settings of the channel to which it is assigned. To create a new mask for the selected source channel, go back up in the menu hierarchy; then, press **Automask**, and press **Create Mask**.

The Source softkey in the Mask Setup menu is the same as the Source softkey in the Automask menu.

- **Test All** – When enabled, all displayed analog channels are included in the mask test. When disabled, just the selected source channel is included in the test.

## Mask Statistics

From the Mask Test menu, press the **Statistics** softkey to enter the Mask Statistics menu.



- **Show Stats** – When you enable **Show Statistics** the following information is displayed:
  - Current mask, name of mask, Channel number, date and time.
  - # of Tests (total number of mask tests executed).
  - Status (Passing, Failing, or Untested).
  - Accumulated test time (in hours, minutes, seconds, and tenths of seconds).

And for each analog channel:

- Number of failures (acquisitions in which the signal excursion went beyond the mask).
- Failure rate (percentage of failures).
- Sigma (the ratio of process sigma to maximum achievable sigma, based on number of waveforms tested).
- **Reset Statistics** – Note that statistics are also reset when:

- Mask Test is switched on after being switched off.
- Clear Mask softkey is pressed.
- An Automask is created.

Additionally, the accumulated time counter is reset whenever the oscilloscope is run after the acquisition was stopped.

- **Transparent** – Enable Transparent mode to write measurement values and statistics on the screen without a background. Disable the Transparent mode to show them with a gray background. The Transparent setting affects mask test statistics, measurement statistics, and reference waveform information display.
- **Clear Display** – Clears acquisition data from the oscilloscope display.

## To manually modify a mask file

You can manually modify a mask file that you created using the Automask function.

- 1 Follow the steps 1–7 in "**To create a mask from a "golden" waveform (Automask)**" on page 181. Do not clear the mask after creating it.
- 2 Attach a USB mass storage device to the oscilloscope.
- 3 Press the **[Save/Recall]** key.
- 4 Press the **Save** softkey.
- 5 Press the **Format** softkey and select **Mask**.
- 6 Press the second softkey and select a destination folder on your USB mass storage device.
- 7 Press the **Press to Save** softkey. This creates an ASCII text file that describes the mask.
- 8 Remove the USB mass storage device and connect it to a PC.
- 9 Open the .msk file your created using a text editor (such as Wordpad).
- 10 Edit, save, and close the file.

The mask file contains the following sections:

- Mask File Identifier.
- Mask Title.
- Mask Violation Regions.

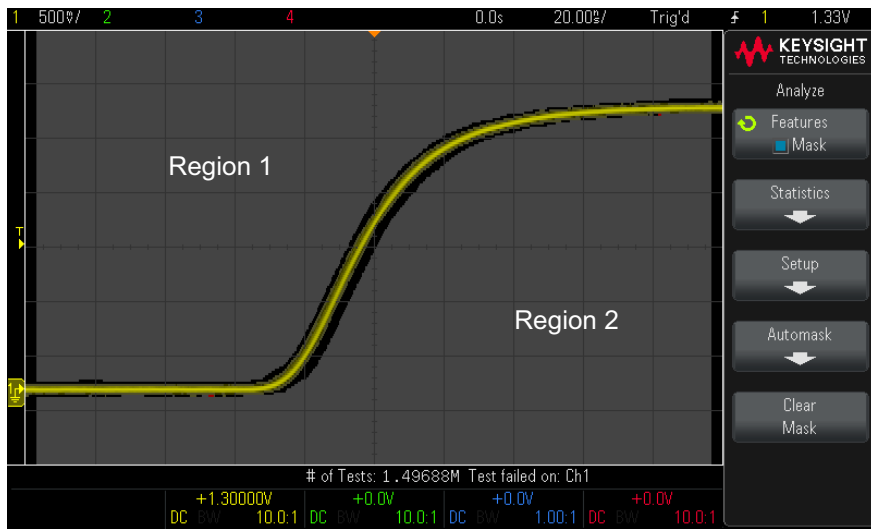
- Oscilloscope Setup Information.

**Mask File Identifier** The Mask File Identifier is MASK\_FILE\_548XX.

**Mask Title** The Mask Title is a string of ASCII characters. Example: autoMask CH1 OCT 03 09:40:26 2008

When a mask file contains the keyword "autoMask" in the title, the edge of the mask is passing by definition. Otherwise, the edge of the mask is defined as a failure.

### Mask Violation Regions



Up to 8 regions can be defined for a mask. They can be numbered 1-8. They can appear in any order in the .msk file. The numbering of the regions must go from top to bottom, left to right.

An Automask file contains two special regions: the region "glued" to the top of the display, and the region that is "glued" to the bottom. The top region is indicated by y-values of "MAX" for the first and last points. The bottom region is indicated by y-values of "MIN" for the first and last points.

The top region must be the lowest numbered region in the file. The bottom region must be the highest numbered region in the file.

Region number 1 is the top mask region. The vertices in Region 1 describe points along a line; that line is the bottom edge of the top portion of the mask.

Similarly, the vertices in Region 2 describe the line that forms the top of the bottom part of the mask.

The vertices in a mask file are normalized. There are four parameters that define how values are normalized:

- X1
- $\Delta X$
- Y1
- Y2

These four parameters are defined in the Oscilloscope Setup portion of the mask file.

The Y-values (normally voltage) are normalized in the file using the following equation:

$$Y_{\text{norm}} = (Y - Y1)/\Delta Y$$

$$\text{where } \Delta Y = Y2 - Y1$$

To convert the normalized Y-values in the mask file to voltage:

$$Y = (Y_{\text{norm}} * \Delta Y) + Y1$$

$$\text{where } \Delta Y = Y2 - Y1$$

The X-values (normally time) are normalized in the file using the following equation:

$$X_{\text{norm}} = (X - X1)/\Delta X$$

To convert the normalized X-values to time:

$$X = (X_{\text{norm}} * \Delta X) + X1$$

### Oscilloscope Setup Information

The keywords "setup" and "end\_setup" (appearing alone on a line) define the beginning and end of the oscilloscope setup region of the mask file. The oscilloscope setup information contains remote programming language commands that the oscilloscope executes when the mask file is loaded.

Any legal remote programming command can be entered in this section.

The mask scaling controls how the normalized vectors are interpreted. This in turn controls how the mask is drawn on the display. The remote programming commands that control mask scaling are:

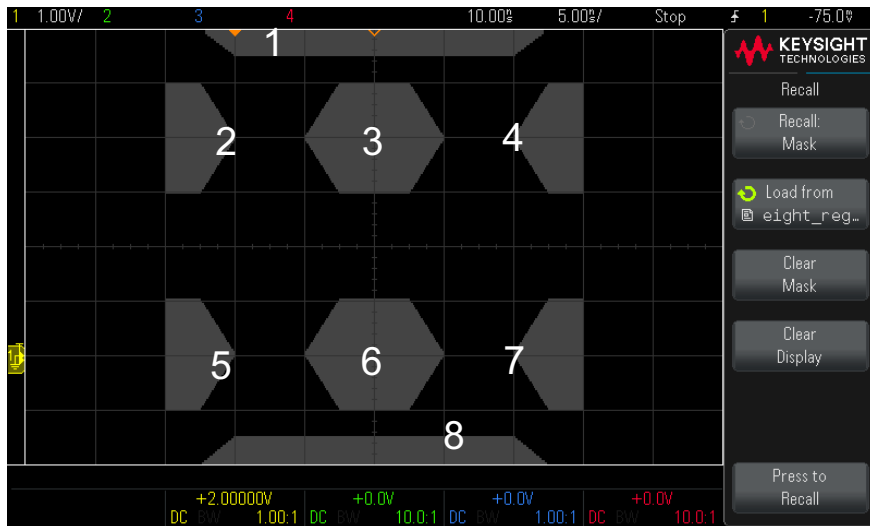
```

:MTES:SCAL:BIND 0
:MTES:SCAL:X1 -400.000E-06
:MTES:SCAL:XDEL +800.000E-06
:MTES:SCAL:Y1 +359.000E-03
:MTES:SCAL:Y2 +2.35900E+00

```

## Building a Mask File

The following mask uses all eight mask regions. The most difficult part of creating a mask file is normalizing the X and Y values from the time and voltage values. This example shows an easy way to convert voltage and time to normalized X and Y values in the mask file.



The following mask file produced the mask shown above:

```

MASK_FILE_548XX

"All Regions"

/* Region Number */ 1
/* Number of vertices */ 4
-12.50,    MAX
-10.00,    1.750
 10.00,    1.750
 12.50,    MAX

/* Region Number */ 2

```

```

/* Number of vertices */ 5
-10.00, 1.000
-12.50, 0.500
-15.00, 0.500
-15.00, 1.500
-12.50, 1.500

/* Region Number */ 3
/* Number of vertices */ 6
-05.00, 1.000
-02.50, 0.500
02.50, 0.500
05.00, 1.000
02.50, 1.500
-02.50, 1.500

/* Region Number */ 4
/* Number of vertices */ 5
10.00, 1.000
12.50, 0.500
15.00, 0.500
15.00, 1.500
12.50, 1.500

/* Region Number */ 5
/* Number of vertices */ 5
-10.00, -1.000
-12.50, -0.500
-15.00, -0.500
-15.00, -1.500
-12.50, -1.500

/* Region Number */ 6
/* Number of vertices */ 6
-05.00, -1.000
-02.50, -0.500
02.50, -0.500
05.00, -1.000
02.50, -1.500
-02.50, -1.500

/* Region Number */ 7
/* Number of vertices */ 5
10.00, -1.000
12.50, -0.500
15.00, -0.500
15.00, -1.500
12.50, -1.500

/* Region Number */ 8
/* Number of vertices */ 4
-12.50, MIN
-10.00, -1.750
10.00, -1.750
12.50, MIN

setup
:MTES:ENAB 1
:CHAN1:RANG +4.00E+00;OFFS +0.0E+00;COUP DC;IMP ONEM;DISP 1;BWL 0;INV 0
:CHAN1:LAB "1";UNIT VOLT;PROB +1.0E+00;PROB:SKEW +0.0E+00;STYP SING
:CHAN2:RANG +16.0E+00;OFFS +1.62400E+00;COUP DC;IMP FIFT;DISP 0;BWL 0;INV
0

```

```

:CHAN2:LAB "2";UNIT VOLT;PROB +1.0E+00;PROB:SKEW +0.0E+00;STYP SING
:CHAN3:RANG +40.0E+00;OFFS +0.0E+00;COUP DC;IMP ONEM;DISP 0;BWL 0;INV 0
:CHAN3:LAB "3";UNIT VOLT;PROB +1.0E+00;PROB:SKEW +0.0E+00;STYP SING
:CHAN4:RANG +40.0E+00;OFFS +0.0E+00;COUP DC;IMP ONEM;DISP 0;BWL 0;INV 0
:CHAN4:LAB "4";UNIT VOLT;PROB +1.0E+00;PROB:SKEW +0.0E+00;STYP SING
:EXT:BWL 0;IMP ONEM;RANG +5E+00;UNIT VOLT;PROB +1.0E+00;PROB:STYP SING
:TIM:MODE MAIN;REF CENT;MAIN:RANG +50.00E-09;POS +0.0E+00
:TRIG:MODE EDGE;SWE AUTO;NREJ 0;HFR 0;HOLD +60E-09
:TRIG:EDGE:SOUR CHAN1;LEV -75.00E-03;SLOP POS;REJ OFF;COUP DC
:ACQ:MODE RTIM;TYPE NORM;COMP 100;COUNT 8;SEGM:COUN 2
:DISP:LAB 0;CONN 1;PERS MIN;SOUR PMEM1
:HARD:APR ";AREA SCR;FACT 0;FFE 0;INKS 1;PAL NONE;LAY PORT
:SAVE:FIL "mask_0"
:SAVE:IMAG:AREA GRAT;FACT 0;FORM NONE;INKS 0;PAL COL
:SAVE:WAV:FORM NONE
:MTES:SOUR CHAN1;ENAB 1;LOCK 1
:MTES:AMAS:SOUR CHAN1;UNIT DIV;XDEL +3.00000000E-001;YDEL +2.00000000E-001
:MTES:SCAL:BIND 0;X1 +0.0E+00;XDEL +1.0000E-09;Y1 +0.0E+00;Y2 +1.00000E+00
:MTES:RMOD FOR;RMOD:TIME +1E+00;WAV 1000;SIGM +6.0E+00
:MTES:RMOD:FACT:STOP 0;PRIN 0;SAVE 0
end_setup

```

In a mask file, all region definitions need to be separated by a blank line.

Mask regions are defined by a number of (x,y) coordinate vertices (as on an ordinary x,y graph). A "y" value of "MAX" specifies the top of the graticule, and a "y" value of "MIN" specifies the bottom of the graticule.

## NOTE

If there are more than 1000 vertices in a mask region, only the first 1000 vertices will be processed.

The mask x,y graph is related to the oscilloscope graticule using the :MTESt:SCALE setup commands.

The oscilloscope's graticule has a time reference location (at the left, center, or right of the screen) and a trigger (t=0) position/delay value relative to the reference. The graticule also has a vertical ground 0 V reference (offset relative to the center of the screen) location.

The X1 and Y1 setup commands relate the mask region's x,y graph origin to the oscilloscope graticule's t=0 and V=0 reference locations, and the XDELt and Y2 setup commands specify the size of the graph's x and y units.

- The X1 setup command specifies the time location of the x,y graph's x origin.
- The Y1 setup command specifies the vertical location of the x,y graph's y origin.



- The XDELta setup command specifies the amount of time associated with each x unit.
- The Y2 setup command is the vertical location of the x,y graph's y=1 value (so in effect,  $Y2 - Y1$  is the YDELta value).

For example:

- With a graticule whose trigger position is 10 ns (before a center screen reference) and whose ground reference (offset) is 2 V below the center of the screen, to place the mask region's x,y graph's origin at center screen, you would set  $X1 = 10$  ns and  $Y1 = 2$  V.
- If the XDELta parameter is set to 5 ns and Y2 is set to 4 V, a mask region whose vertices are (-1, 1), (1, 1), (1, -1), and (-1, -1) goes from 5 ns to 15 ns and from 0 V to 4 V.
- If you move the mask region's x,y graph origin to the  $t=0$  and  $V=0$  location by setting  $X1 = 0$  and  $Y1 = 0$ , the same vertices define a region that goes from -5 ns to 5 ns and from -2 V to 2 V.

## NOTE

Although a mask can have up to 8 regions, in any given vertical column, it is only possible to define 4 regions. When there are 4 regions in a vertical column, one region must be tied to the top (using the MAX y value) and one must be tied to the bottom (using the MIN y value).

## How is mask testing done?

InfiniiVision oscilloscopes start mask testing by creating a database that is 200 x 640 for the waveform viewing area. Each location in the array is designated as either a violation or a pass area. Each time a data point from a waveform occurs in a violation area a failure is logged. If **Test All** was selected, every active analog channel is tested against the mask database for each acquisition. Over 2 billion failures can be logged per-channel. The number of acquisitions tested is also logged and displayed as "# of Tests".

The mask file allows greater resolution than the 200 X 640 database. Some quantization of data occurs to reduce the mask file data for display on-screen.

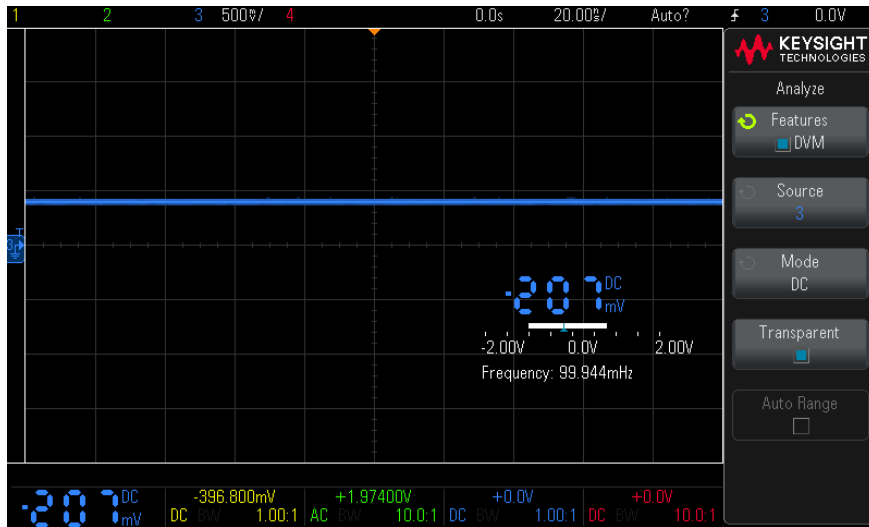


# 17 Digital Voltmeter

The Digital Voltmeter (DVM) analysis feature provides 3-digit voltage and 5-digit frequency measurements using any analog channel. DVM measurements are asynchronous from the oscilloscope's acquisition system and are always acquiring.

The DVM display is a seven-segment readout like you would see on a digital voltmeter. It shows the selected mode as well as the units. Units are selected using the **Units** softkey in the Channel Probe menu.

After pressing the **[Analyze]** key, the DVM display also appears in the graticule along with a scale and the frequency counter value. The DVM scale is determined by the channel's vertical scale and reference level. The scale's blue triangle pointer shows the most recent measurement. The white bar above that shows the measurement extrema over the last 3 seconds.



The DVM makes accurate RMS measurements when the signal frequency is between 20 Hz and 100 kHz. When the signal frequency is outside this range, "<BW Limit?" or ">BW Limit?" appears in the DVM display to caution you about inaccurate RMS measurement results.

To use the digital voltmeter:

- 1 Press the **[Analyze]** key.
- 2 Press **Features**; then, select **Digital Voltmeter**.
- 3 Press **Features** again to enable the DVM measurements.
- 4 Press the **Source** softkey and turn the Entry knob to select the analog channel on which digital voltmeter (DVM) measurements are made.

The selected channel does not have to be on (displaying a waveform) in order for DVM measurements to be made.

- 5 Press the **Mode** softkey and turn the Entry knob to select the digital voltmeter (DVM) mode:
  - **DC** – displays the DC value of the acquired data.
  - **DC RMS** – displays the root-mean-square value of the acquired data.
  - **AC RMS** – displays the root-mean-square value of the acquired data, with the DC component removed.

- **Frequency** – displays the frequency counter measurement.
- 6** Press **Transparent** to toggle between a transparent and shaded background for the DVM display.
  - 7** If the selected source channel is not used in oscilloscope triggering, press **Auto Range** to disable or enable automatic adjustment of the DVM channel's vertical scale, vertical (ground level) position, and trigger (threshold voltage) level (used for the counter frequency measurement).

When enabled, **Auto Range** overrides attempted adjustments of the channel's vertical scale and position knobs.

When disabled, you can use the channel's vertical scale and position knobs normally.



# 18 Frequency Response Analysis

To make connections / 199

To set up and run the analysis / 200

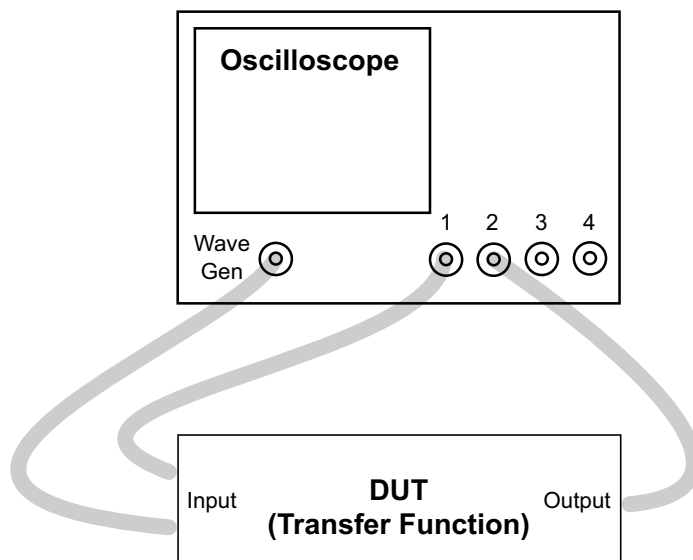
To view and save the analysis results / 202

On G-suffix oscilloscope models (that have a built-in waveform generator), the Frequency Response Analysis (FRA) feature controls the built-in waveform generator to sweep a sine wave across a range of frequencies while measuring the input to and output from a device under test (DUT). At each frequency, gain (A) and phase are measured and plotted on a frequency response Bode chart.

When the frequency response analysis completes, you can move a marker across the chart to see the measured gain and phase values at each frequency point. You can also adjust the chart's scale and offset settings for the gain and phase plots.

## To make connections

The waveform generator output is connected to a device under test (DUT). The input to the device and the output from the device are probed by the oscilloscope's input channels.



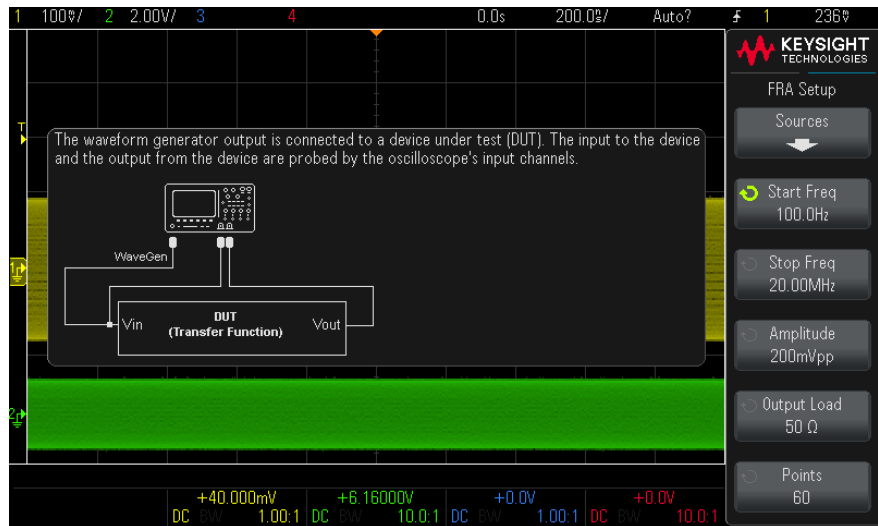
To set up and run the analysis

- 1 Press the **[Analyze]** key.
- 2 Press **Features**; then, select **Frequency Response Analysis**.
- 3 Press **Features** again to enable the feature.





4 Press the **Setup** softkey.



In the FRA Setup menu, these softkeys are present for setting up the frequency response analysis:

- **Sources** – opens a menu for specifying the oscilloscope channels probing the DUT's input and output.
- **Start Freq, Stop Freq** – specifies the start frequency and the stop frequency in the sweep.

To toggle between coarse, fine, and log scale decade adjustment, press this softkey again or push the Entry knob. The "~" character appears in the softkey label when fine adjustment is enabled, and the "10<sup>X</sup>" characters appear when decade adjustment is enabled.


Because the stop frequency value must be greater than the start value, increasing the start value can also cause the stop value to be increased. Likewise, decreasing the stop value can also cause the start value to be decreased.

- **Amplitude** – specifies the waveform generator amplitude.
- **Output Load** – specifies the waveform generator expected output load impedance.

The output impedance of the Gen Out signal is fixed at 50 ohms. However, the output load selection lets the waveform generator display the correct amplitude and offset levels for the expected output load. If the actual load impedance is different than the selected value, the displayed amplitude and offset levels will be incorrect.

- **Points** – sets the total number of points to use for the sweep.

The number of points may be limited depending on the specified frequency range.

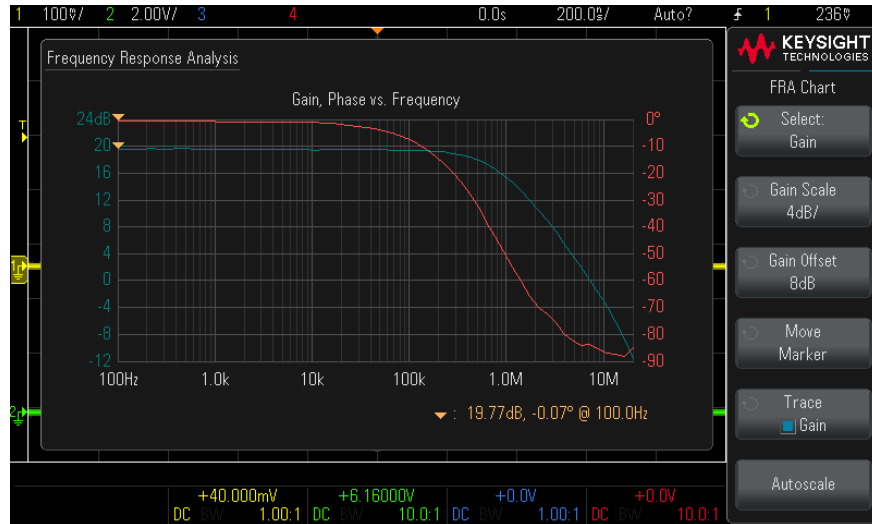
**5** Press the  Back key to return to the Analyze menu.

**6** Press the **Run Analysis** softkey.

## To view and save the analysis results

After the frequency response analysis completes, the results are displayed in a Bode plot chart. You can press the **Move Marker** softkey and turn the Entry knob to move a marker across the chart to see the measured gain and phase values at each frequency point.

To adjust the chart's scale, offset, and frequency range for the gain and phase plots, press the **Chart** softkey. In the FRA Chart menu, these softkeys let you make adjustments:



- **Select:** — Press this softkey or turn the Entry knob to select the chart parameters to adjust:
  - **Gain** — use the **Gain Scale** and **Gain Offset** softkeys to adjust the gain plot's vertical scale and offset.
  - **Phase** — use the **Phase Scale** and **Phase Offset** softkeys to adjust the phase plot's vertical scale and offset.
  - **Frequency** — use the **Start Freq** and **Stop Freq** softkeys to adjust the chart's starting and ending frequency values.

To toggle between coarse, fine, and log scale decade adjustment, press this softkey again or push the Entry knob. The "~" character appears in the softkey label when fine adjustment is enabled, and the "10<sup>X</sup>" characters appear when decade adjustment is enabled.

Because the chart's ending frequency value must be greater than the starting frequency value, increasing the starting value can also cause the ending value to be increased. Likewise, decreasing the ending value can also cause the starting value to be decreased.

- **Move Marker** – lets you turn the Entry knob to move a marker across the chart to see the measured gain and phase values at each frequency point.
- **Trace** – lets you choose the plot(s) that are included in the chart. Press this softkey, then turn the Entry knob to select either gain or phase, then push the knob or press the softkey again to enable or disable the plot.
- **Autoscale** – automatically sets the scale and offset of the gain and phase plots based on the measured values.

You can save the analysis results by choosing **[Save/Recall] > Save > Format** and selecting the **Frequency Response Analysis data (\*.csv)** option.

# 19 Waveform Generator

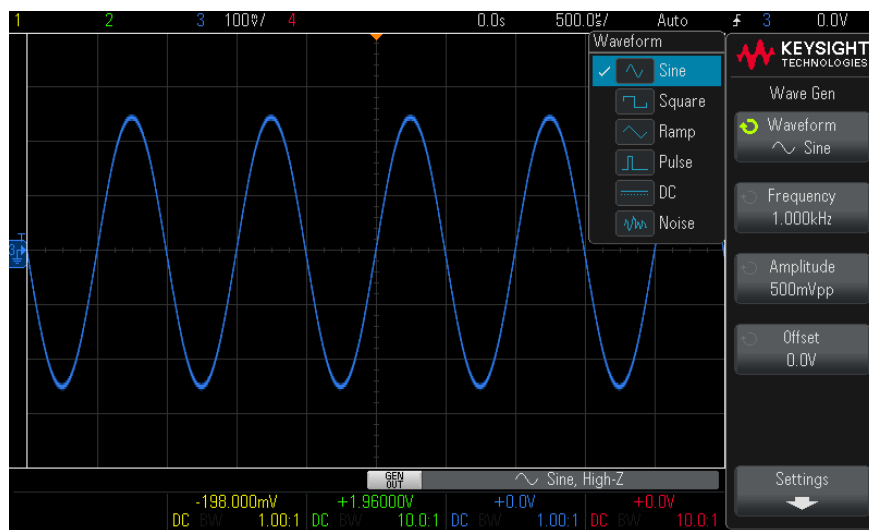
- To select generated waveform types and settings / 205
- To specify the expected output load / 208
- To use waveform generator logic presets / 209
- To add noise to the waveform generator output / 209
- To add modulation to the waveform generator output / 210
- To restore waveform generator defaults / 215

On G-suffix oscilloscope models, a waveform generator is built into the oscilloscope. The waveform generator gives you an easy way to provide input signals when testing circuitry with the oscilloscope.

Waveform generator settings can be saved and recalled with oscilloscope setups. See [Chapter 20](#), "Save/Recall (Setups, Screens, Data)," starting on page 217.

## To select generated waveform types and settings

- 1 To access the Wave Gen menu and enable or disable the waveform generator output on the front panel Gen Out BNC, press the **[Wave Gen]** key.  
  
When waveform generator output is enabled, the **[Wave Gen]** key is illuminated. When waveform generator output is disabled, the **[Wave Gen]** key is off.  
  
The waveform generator output is always disabled when the instrument is first turned on.  
  
The waveform generator output is automatically disabled if excessive voltage is applied to the Gen Out BNC.
- 2 In the Wave Gen menu, press the **Waveform** softkey and turn the Entry knob to select the waveform type.



- 3 Depending on the selected waveform type, use the remaining softkeys and the Entry knob to set the waveform's characteristics.

Waveform Type	Characteristics
Sine	Use the <b>Frequency/Frequency Fine/Period/Period Fine, Amplitude/High-Level, and Offset/Low-Level</b> softkeys to set the sine signal parameters. The frequency can be adjusted from 100 mHz to 20 MHz.
Square	Use the <b>Frequency/Frequency Fine/Period/Period Fine, Amplitude/High-Level, Offset/Low-Level, and Duty Cycle</b> softkeys to set the square wave signal parameters. The frequency can be adjusted from 100 mHz to 10 MHz. The duty cycle can be adjusted from 1% to 99% up to 500 kHz. At higher frequencies, the adjustment range narrows to not allow pulse widths less than 20 ns. For example: <ul style="list-style-type: none"> <li>▪ At 1 MHz, the duty cycle can be adjusted from 2% to 98%.</li> <li>▪ At 5 MHz, the duty cycle can be adjusted from 10% to 90%.</li> <li>▪ At 10 MHz, the duty cycle can be adjusted from 20% to 80%.</li> </ul>
Ramp	Use the <b>Frequency/Frequency Fine/Period/Period Fine, Amplitude/High-Level, Offset/Low-Level, and Symmetry</b> softkeys to set the ramp signal parameters. The frequency can be adjusted from 100 mHz to 100 kHz. Symmetry represents the amount of time per cycle that the ramp waveform is rising and can be adjusted from 0% to 100%.
Pulse	Use the <b>Frequency/Frequency Fine/Period/Period Fine, Amplitude/High-Level, Offset/Low-Level, and Width/Width Fine</b> softkeys to set the pulse signal parameters. The frequency can be adjusted from 100 mHz to 10 MHz. The pulse width can be adjusted from 20 ns to the period minus 20 ns.
DC	Use the <b>Offset</b> softkey to set the DC level.
Noise	Use the <b>Amplitude/High-Level</b> and <b>Offset/Low-Level</b> to set the noise signal parameters.

For all waveform types, the output amplitude, into 50  $\Omega$ , can be adjusted from 10 mVpp to 2.5 Vpp (or from 20 mVpp to 5 Vpp into an open-circuit load).

Pressing a signal parameter softkey can open a menu for selecting the type of adjustment. For example, you can choose to enter amplitude and offset values, or you can choose to enter high-level and low-level values. Or, you can choose to enter frequency values or period values. Keep pressing the softkey to select the type of adjustment. Turn the Entry knob to adjust the value.

Notice that you can select between coarse and fine adjustments for frequency, period, and width. Also, pushing the Entry knob is a quick way to toggle between coarse and fine adjustments.

The **Settings** softkey opens the Wave Gen Settings menu which lets you make other settings related to the waveform generator.

See:

- "To specify the expected output load" on page 208
- "To use waveform generator logic presets" on page 209
- "To restore waveform generator defaults" on page 215



## To specify the expected output load

- 1 If the Wave Gen menu is not currently displayed on the oscilloscope's softkeys, press the **[Wave Gen]** key.
- 2 In the Wave Gen menu, press the **Settings** softkey.
- 3 In the Wave Gen Settings menu, press the **Out Load** softkey and turn the Entry knob to select:
  - **50 Ω**



### High-Z

The output impedance of the Gen Out BNC is fixed at 50 ohms. However, the output load selection lets the waveform generator display the correct amplitude and offset levels for the expected output load.

If the actual load impedance is different than the selected value, the displayed amplitude and offset levels will be incorrect.

## To use waveform generator logic presets

With logic level presets, you can easily set the output voltage to TTL, CMOS (5.0V), CMOS (3.3V), CMOS (2.5V), or ECL compatible Low and High levels.

- 1 If the Wave Gen menu is not currently displayed on the oscilloscope's softkeys, press the **[Wave Gen]** key.
- 2 In the Wave Gen menu, press the **Settings** softkey.
- 3 In the Wave Gen Settings menu, press the **Logic Presets** softkey.
- 4 In the Wave Gen Presets menu, press one of the softkeys to set the generated signal's Low and High voltages to logic compatible levels:

Softkey (logic levels)	Low level	High level, 50 ohm expected output load	High level, high-Z expected output load
TTL	0 V	+2.5 V (TTL compatible)	+5 V
CMOS (5.0V)	0 V	Not Available	+5 V
CMOS (3.3V)	0 V	+2.5 V (CMOS compatible)	+3.3 V
CMOS (2.5V)	0 V	+2.5 V	+2.5 V
ECL	-1.7 V	-0.8 V (ECL compatible)	-0.9 V

## To add noise to the waveform generator output

- 1 If the Wave Gen menu is not currently displayed on the oscilloscope's softkeys, press the **[Wave Gen]** key.

- 2 In the Wave Gen menu, press the **Settings** softkey.
- 3 In the Wave Gen Settings menu, press the **Add Noise** softkey and turn the Entry knob to select the amount of white noise to add to the waveform generator output.

Note that adding noise affects edge triggering on the waveform generator source (see "**Edge Trigger**" on page 99). This is because the trigger comparator is located after the noise source.

## To add modulation to the waveform generator output

Modulation is where an original carrier signal is modified according to the amplitude of a second modulating signal. The modulation type (AM, FM, or FSK) specifies how the carrier signal is modified.

To enable and set up modulation for the waveform generator output:

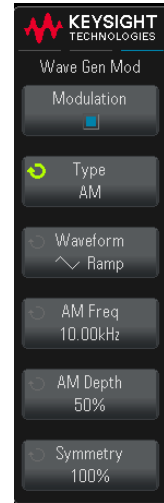
- 1 If the Wave Gen menu is not currently displayed on the oscilloscope's softkeys, press the **[Wave Gen]** key.
- 2 In the Wave Gen menu, press the **Settings** softkey.
- 3 In the Wave Gen Settings menu, press the **Modulation** softkey.

#### 4 In the Wave Gen Mod menu:

- Press the **Modulation** softkey to enable or disable modulated waveform generator output.

You can enable modulation for all waveform generator function types except pulse, DC, and noise.

- Press the **Type** softkey and turn the Entry knob to select the modulation type:
  - **Amplitude Modulation (AM)** – the amplitude of the original carrier signal is modified according to the amplitude of the modulating signal. See "[To set up Amplitude Modulation \(AM\)](#)" on page 211.
  - **Frequency Modulation (FM)** – the frequency of the original carrier signal is modified according to the amplitude of the modulating signal. See "[To set up Frequency Modulation \(FM\)](#)" on page 212.
  - **Frequency-Shift Keying Modulation (FSK)** – the output frequency "shifts" between the original carrier frequency and a "hop frequency" at the specified FSK rate. The FSK rate specifies a digital square wave modulating signal. See "[To set up Frequency-Shift Keying Modulation \(FSK\)](#)" on page 214.



### To set up Amplitude Modulation (AM)

In the Wave Gen Mod menu (under **[Wave Gen] > Settings > Modulation**):

- 1 Press the **Type** softkey and turn the Entry knob to select **Amplitude Modulation (AM)**.
- 2 Press the **Waveform** softkey and turn the Entry knob to select the shape of the modulating signal:
  - **Sine**
  - **Square**
  - **Ramp**

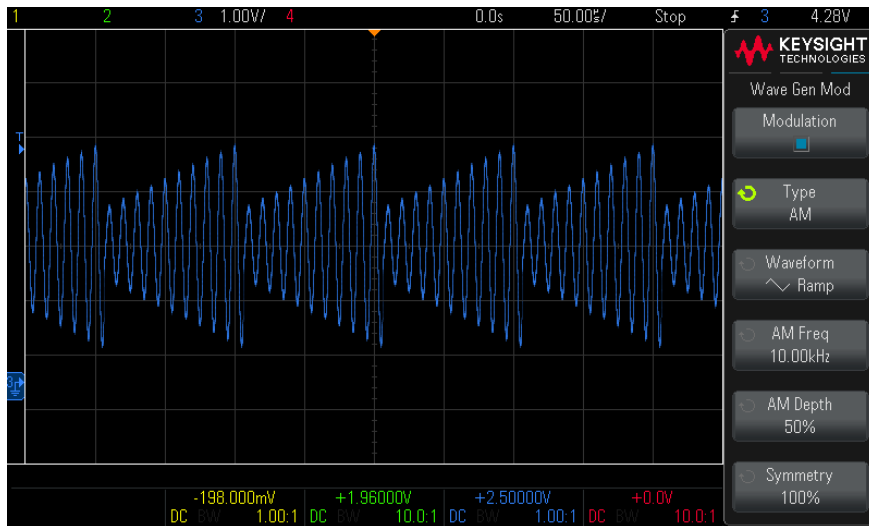
When the **Ramp** shape is selected, a **Symmetry** softkey appears so that you can specify the amount of time per cycle that the ramp waveform is rising.

- 3 Press the **AM Freq** softkey and turn the Entry knob to specify the frequency of the modulating signal.

- 4 Press the **AM Depth** softkey and turn the Entry knob to specify the amount of amplitude modulation.

AM Depth refers to the portion of the amplitude range that will be used by the modulation. For example, a depth setting of 80% causes the output amplitude to vary from 10% to 90% ( $90\% - 10\% = 80\%$ ) of the original amplitude as the modulating signal goes from its minimum to maximum amplitude.

The following screen shows an AM modulation of a 100 kHz sine wave carrier signal.



## To set up Frequency Modulation (FM)

In the Wave Gen Mod menu (under **[Wave Gen] > Settings > Modulation**):

- 1 Press the **Type** softkey and turn the Entry knob to select **Frequency Modulation (FM)**.
- 2 Press the **Waveform** softkey and turn the Entry knob to select the shape of the modulating signal:
  - **Sine**
  - **Square**
  - **Ramp**

When the **Ramp** shape is selected, a **Symmetry** softkey appears so that you can specify the amount of time per cycle that the ramp waveform is rising.

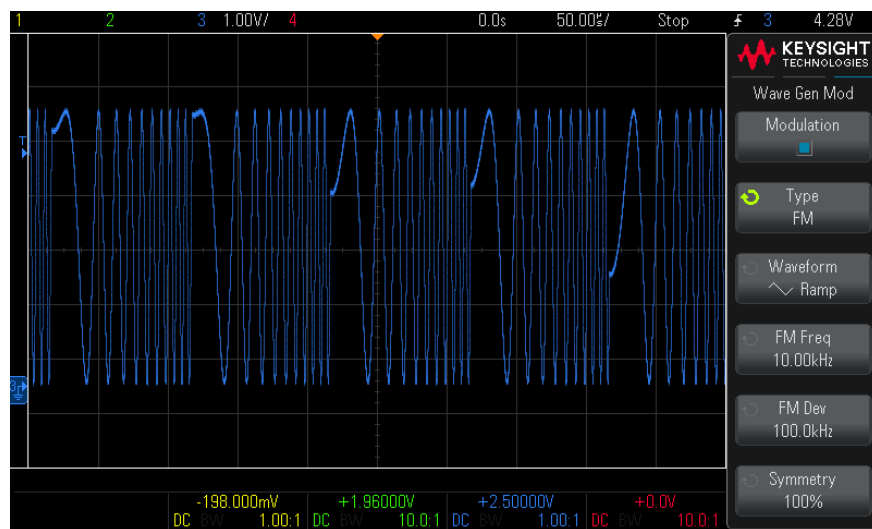
- 3 Press the **FM Freq** softkey and turn the Entry knob to specify the frequency of the modulating signal.
- 4 Press the **FM Dev** softkey and turn the Entry knob to specify the frequency deviation from the original carrier signal frequency.

When the modulating signal is at its maximum amplitude, the output frequency is the carrier signal frequency plus the deviation amount, and when the modulating signal is at its minimum amplitude, the output frequency is the carrier signal frequency minus the deviation amount.

The frequency deviation cannot be greater than the original carrier signal frequency.

Also, the sum of the original carrier signal frequency and the frequency deviation must be less than or equal to the maximum frequency for the selected waveform generator function plus 100 kHz.

The following screen shows an FM modulation of a 100 kHz sine wave carrier signal.



## To set up Frequency-Shift Keying Modulation (FSK)

In the Wave Gen Mod menu (under **[Wave Gen] > Settings > Modulation**):

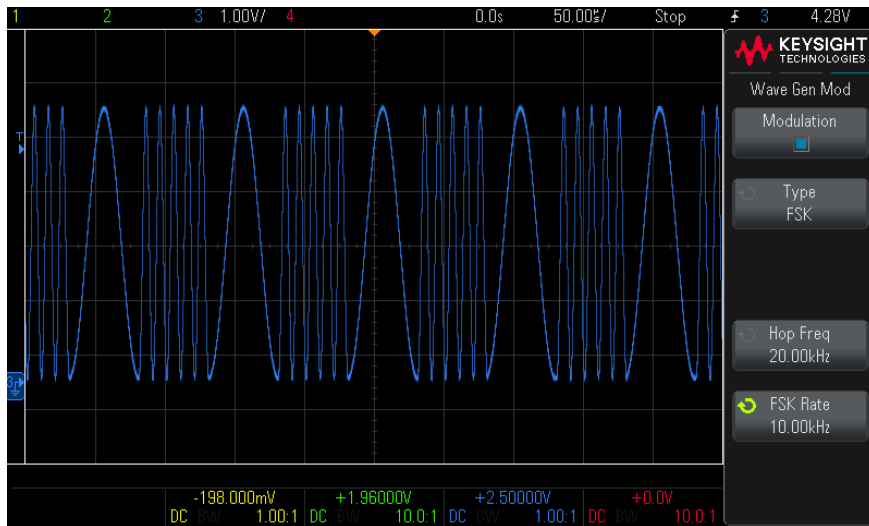
- 1 Press the **Type** softkey and turn the Entry knob to select **Frequency-Shift Keying Modulation (FSK)**.
- 2 Press the **Hop Freq** softkey and turn the Entry knob to specify the "hop frequency".

The output frequency "shifts" between the original carrier frequency and this "hop frequency".

- 3 Press the **FSK Rate** softkey and turn the Entry knob to specify the rate at which the output frequency "shifts".

The FSK rate specifies a digital square wave modulating signal.

The following screen shows an FSK modulation of a 100 kHz sine wave carrier signal.



## To restore waveform generator defaults

- 1** If the Wave Gen menu is not currently displayed on the oscilloscope's softkeys, press the **[Wave Gen]** key.
- 2** In the Wave Gen menu, press the **Settings** softkey.
- 3** In the Wave Gen Settings menu, press the **Default Wave Gen** softkey.

The waveform generator factory default settings (1 kHz sine wave, 500 mVpp, 0 V offset, High-Z output load) are restored.





## 20 Save/Recall (Setups, Screens, Data)

Saving Setups, Screen Images, or Data / 217

Recalling Setups, Masks, or Reference Waveforms / 224

Recalling Default Setups / 226

Performing a Secure Erase / 226

Oscilloscope setups, reference waveforms, and mask files can be saved to internal oscilloscope memory or to a USB storage device and recalled later. You can also recall default or factory default setups.

Oscilloscope screen images can be saved to a USB storage device in BMP or PNG formats.

Acquired waveform data can be saved to a USB storage device in comma-separated value (CSV), ASCII XY, and binary (BIN) formats.

There is also a command to securely erase all the oscilloscope's non-volatile internal memory.

### Saving Setups, Screen Images, or Data

- 1 Press the **[Save/Recall]** key.
- 2 In the Save/Recall menu, press **Save**.
- 3 In the Save menu, press **Format**, then, turn the Entry knob to select the type of file you want to save:

- **Setup (\*.scp)** – The oscilloscope's horizontal timebase, vertical sensitivity, trigger mode, trigger level, measurements, cursors, and math function settings that tell the oscilloscope how to make a particular measurement. See ["To save setup files"](#) on page 219.
- **8-bit Bitmap image (\*.bmp)** – The complete screen image in a reduced color (8-bit) bitmap format. See ["To save BMP or PNG image files"](#) on page 219.
- **24-bit Bitmap image (\*.bmp)** – The complete screen image in a 24-bit color bitmap format. See ["To save BMP or PNG image files"](#) on page 219.
- **PNG 24-bit image (\*.png)** – The complete screen image in a 24-bit color PNG format that uses lossless compression. Files are much smaller than the BMP format. See ["To save BMP or PNG image files"](#) on page 219.
- **CSV data (\*.csv)** – This creates a file of comma-separated values of all displayed channels and math waveforms. This format is suitable for spreadsheet analysis. See ["To save CSV, ASCII XY, or BIN data files"](#) on page 220.
- **ASCII XY data (\*.csv)** – This creates separate files of comma-separated values for each displayed channel. This format is also suitable for spreadsheets. See ["To save CSV, ASCII XY, or BIN data files"](#) on page 220.
- **Reference Waveform data (\*.h5)** – Saves waveform data in a format that can be recalled to one of the oscilloscope's reference waveform locations. See ["To save reference waveform files to a USB storage device"](#) on page 222.
- **Multi Channel Waveform data (\*.h5)** – Saves multiple channels of waveform data in a format that can be opened by the N8900A Infiniium Offline oscilloscope analysis software. You can recall the first Analog or Math channel from a multi channel waveform data file.
- **Binary data (\*.bin)** – This creates a binary file, with a header, and data in the form of time and voltage pairs. This file is much smaller than the ASCII XY data file. See ["To save CSV, ASCII XY, or BIN data files"](#) on page 220.
- **Lister data (\*.csv)** – This is a CSV format file containing serial decode row information with commas separating the columns. See ["To save Lister data files"](#) on page 222.
- **Mask (\*.msk)** – This creates a mask file in a Keysight proprietary format that can be read by Keysight InfiniiVision oscilloscopes. A mask data file includes some oscilloscope setup information, but not all setup information. To save all setup information including the mask data file, choose "Setup (\*.scp)" format instead. See ["To save masks"](#) on page 223.

- **Frequency Response Analysis data (\*.csv)** – This creates a file of comma-separated values for the Frequency Response Analysis results table values. In the saved file, there are three data columns: frequency (Hz), gain (dB), and phase (degrees). See **"To view and save the analysis results"** on page 202.

You can also configure the **[Quick Action]** key to save setups, screen images, or data. See **"Configuring the [Quick Action] Key"** on page 248.

## To save setup files

Setup files can be saved to one of 10 internal (/User Files) locations or to an external USB storage device.

- 1 Press **[Save/Recall] > Save > Format**; then, turn the Entry knob to select **Setup (\*.scp)**.
- 2 Press the softkey in the second position and use the Entry knob to navigate to the save location. See **"To navigate storage locations"** on page 223.
- 3 Finally, press the **Press to Save** softkey.

A message indicating whether the save was successful is displayed.

Setup files have the extension SCP. These extensions appear when using the File Explorer (see **"File Explorer"** on page 236), but they do not appear when using the Recall menu.

## To save BMP or PNG image files

Image files can be saved to an external USB storage device.

- 1 Press **[Save/Recall] > Save > Format**; then, turn the Entry knob to select **8-bit Bitmap image (\*.bmp), 24-bit Bitmap image (\*.bmp), or PNG 24-bit image (\*.png)**.
- 2 Press the softkey in the second position and use the Entry knob to navigate to the save location. See **"To navigate storage locations"** on page 223.
- 3 Press the **Settings** softkey.

In the File Settings menu, you have these softkeys and options:

- **Setup Info** – setup information (vertical, horizontal, trigger, acquisition, math, and display settings) is also saved in a separate file with a TXT extension.
- **Invert Graticule** – the graticule in the image file has a white background instead of the black background that appears on-screen.
- **Palette** – lets you choose between **Color** or **Grayscale** images.

- 4 Finally, press the **Press to Save** softkey.

A message indicating whether the save was successful is displayed.

**NOTE**

When saving screen images, the oscilloscope uses the last menu visited before pressing the **[Save/Recall]** key. This lets you save any relevant information within the softkey menu area.

To save a screen image showing the Save/Recall menu at the bottom, press the **[Save/Recall]** key twice before saving the image.

**NOTE**

You can also save the oscilloscope's display image using a web browser. See **"Get Image"** on page 256 for details.

See Also · **"To add an annotation"** on page 87

## To save CSV, ASCII XY, or BIN data files

Data files can be saved to an external USB storage device.

- 1 Press **[Save/Recall] > Save > Format**; then, turn the Entry knob to select **CSV data (\*.csv)**, **ASCII XY data (\*.csv)**, or **Binary data (\*.bin)**.
- 2 Press the softkey in the second position and use the Entry knob to navigate to the save location. See **"To navigate storage locations"** on page 223.
- 3 Press the **Settings** softkey.

In the File Settings menu, you have these softkeys and options:

- **Setup Info** – when enabled, setup information (vertical, horizontal, trigger, acquisition, math, and display settings) is also saved in a separate file with a TXT extension.
  - **Length** – sets the number of data points that will be output to the file. For more information, see **"Length Control"** on page 221.
  - **Save Seg** – when data is acquired to segmented memory, you can specify whether the currently displayed segment is saved or all acquired segments are saved. (See also **"Saving Data from Segmented Memory"** on page 143.)
- 4 Finally, press the **Press to Save** softkey.

A message indicating whether the save was successful is displayed.

- See Also
- ["Binary Data \(.bin\) Format"](#) on page 266
  - ["CSV and ASCII XY files"](#) on page 273
  - ["Minimum and Maximum Values in CSV Files"](#) on page 274

## Length Control

The **Length** control is available when saving data to CSV, ASCII XY, or BIN format files. It sets the number of data points that will be output to the file. Only displayed data points are saved.

The maximum number of data points depends on these things:

- Whether acquisitions are running. When stopped, data comes from the raw acquisition record. When running, data comes from the smaller measurement record.
- Whether the oscilloscope was stopped using **[Stop]** or **[Single]**. Running acquisitions split memory to provide fast waveform update rates. Single acquisitions use full memory.
- Whether only one channel of a pair is turned on. (Channels 1 and 2 are one pair, channels 3 and 4 are the other.) Acquisition memory is divided among the channels in a pair.
- On 2-channel oscilloscope models, whether the external trigger input channel is on. The displayed external channel consumes acquisition memory.
- Whether reference waveforms are on. Displayed reference waveforms consume acquisition memory.
- Whether segmented memory (available on DSOX1200-Series models) is on. Acquisition memory is divided by the number of segments.
- The horizontal time/div (sweep speed) setting. At faster settings, fewer data points appear on the display.
- When saving to a CSV format file, the maximum number of data points is 50,000.

When necessary, the Length control performs a "1 of n" decimation of the data. For example: if the **Length** is set to 1000, and you are displaying a record that is 5000 data points in length, four of each five data points will be decimated, creating an output file 1000 data points in length.

When saving waveform data, the save times depend on the chosen format:

Data File Format	Save Times
BIN	fastest
ASCII XY	medium
CSV	slowest

- See Also
- ["Binary Data \(.bin\) Format"](#) on page 266
  - ["CSV and ASCII XY files"](#) on page 273
  - ["Minimum and Maximum Values in CSV Files"](#) on page 274

### To save Lister data files

Lister data files can be saved to an external USB storage device.

- 1 Press **[Save/Recall]** > **Save** > **Format**; then, turn the Entry knob to select **Lister data (\*.csv)**.
- 2 Press the softkey in the second position and use the Entry knob to navigate to the save location. See ["To navigate storage locations"](#) on page 223.
- 3 Press the **Settings** softkey.

In the File Settings Menu, you have these softkeys and options:

- **Setup Info** – when enabled, setup information (vertical, horizontal, trigger, acquisition, math, and display settings) is also saved in a separate file with a TXT extension.

- 4 Finally, press the **Press to Save** softkey.

A message indicating whether the save was successful is displayed.

### To save reference waveform files to a USB storage device

- 1 Press the **[Save/Recall]** key.
- 2 In the Save/Recall menu, press the **Save** softkey.
- 3 In the Save menu, press the **Format** softkey and turn the Entry knob to select **Reference Waveform data (\*.h5)**.
- 4 Press the **Source** softkey and turn the Entry knob to select the source waveform.
- 5 Press the softkey in the second position and use the Entry knob to navigate to the save location. See ["To navigate storage locations"](#) on page 223.

- 6 Finally, press the **Press to Save** softkey.

A message indicating whether the save was successful is displayed.

## To save masks

Mask files can be saved to one of four internal (/User Files) locations or to an external USB storage device.

- 1 Press [**Save/Recall**] > **Save** > **Format**; then, turn the Entry knob to select **Mask (\*.msk)**.
- 2 Press the softkey in the second position and use the Entry knob to navigate to the save location. See "**To navigate storage locations**" on page 223.
- 3 Finally, press the **Press to Save** softkey.

A message indicating whether the save was successful is displayed.

Mask files have the extension MSK.

### NOTE

Masks are also saved as part of setup files. See "**To save setup files**" on page 219.

---

**See Also** • **Chapter 16**, "Mask Testing," starting on page 181

## To navigate storage locations

When saving or recalling files, the softkey in the second position of the Save menu or Recall menu, along with the Entry knob, are used to navigate to storage locations. The storage locations can be internal oscilloscope storage locations (for setup files or mask files) or they can be external storage locations on a connected USB storage device.

The softkey in the second position can have these labels:

- **Press to go** – when you can push the Entry knob to navigate to a new folder or storage location.
- **Location** – when you have navigated to the current folder location (and are not saving files).
- **Save to** – when you can save to the selected location.
- **Load from** – when you can recall from the selected file.

When saving files:

- The proposed file name is shown in the **Save to file =** line.
- To overwrite an existing file, browse to that file and select it. To create a new file name, see **"To enter file names"** on page 224.

## To enter file names

To create new file names when saving files to a USB storage device:

- 1 In the Save menu, press the **File Name** softkey.

You must have a USB storage device connected to the oscilloscope for this softkey to be active.

- 2 In the File Name menu, use the **Spell**, **Enter**, and **Delete Character** softkeys to enter the file name:
  - **Spell** – press this softkey and turn the Entry knob to select the character at the current position.
  - **Enter** – press this softkey to enter characters and move the cursor to the next character position. Pushing the Entry knob is the same as pressing the **Enter** softkey.
  - **Delete Character** – press this softkey to delete the character at the current position.

### NOTE

You can use a connected USB keyboard instead of using the **Spell** (and other) character editing softkeys.

---

When available, the **Increment** softkey can be used to enable or disable automatically incremented file names. Auto increment adds a numeric suffix to your file name and increments the number with each successive save. It will truncate characters as necessary when the file name length is at maximum and more digits are required for the numeric portion of the file name.

## Recalling Setups, Masks, or Reference Waveforms

- 1 Press the **[Save/Recall]** key.
- 2 In the Save/Recall menu, press **Recall**.



- 3 In the Recall menu, press **Recall**; then, turn the Entry knob to select the type of file you want to recall:
  - **Setup (\*.scp)** – See "To recall setup files" on page 225.
  - **Mask (\*.msk)** – See "To recall mask files" on page 225.
  - **Reference Waveform data (\*.h5)** – See "To recall reference waveform files from a USB storage device" on page 226.

You can also recall setups and mask files by loading them using the File Explorer. See "File Explorer" on page 236.

You can also configure the [Quick Action] key to recall setups, masks, or reference waveforms. See "Configuring the [Quick Action] Key" on page 248.

## To recall setup files

Setup files can be recalled from one of 10 internal (/User Files) locations or from an external USB storage device.

- 1 Press [**Save/Recall**] > **Recall** > **Recall**; then, turn the Entry knob to select **Setup (\*.scp)**.
- 2 Press the softkey in the second position and use the Entry knob to navigate to the file to recall. See "To navigate storage locations" on page 223.
- 3 Press the **Press to Recall** softkey.  
A message indicating whether the recall was successful is displayed.
- 4 If you would like to clear the display, press **Clear Display**.

## To recall mask files

Mask files can be recalled from one of four internal (/User Files) locations or from an external USB storage device.

- 1 Press [**Save/Recall**] > **Recall** > **Recall**; then, turn the Entry knob to select **Mask (\*.msk)**.
- 2 Press the softkey in the second position and use the Entry knob to navigate to the file to recall. See "To navigate storage locations" on page 223.
- 3 Press the **Press to Recall** softkey.  
A message indicating whether the recall was successful is displayed.
- 4 If you would like to clear the display or clear the recalled mask, press **Clear Display** or **Clear Mask**.

To recall reference waveform files from a USB storage device

- 1 Press the **[Save/Recall]** key.
- 2 In the Save/Recall menu, press the **Recall** softkey.
- 3 In the Recall menu, press the **Recall** softkey and turn the Entry knob to select **Reference Waveform data (\*.h5)**.
- 4 Press the **To Ref:** softkey and turn the Entry knob to select the desired reference waveform location.
- 5 Press the softkey in the second position and use the Entry knob to navigate to the file to recall. See "**To navigate storage locations**" on page 223.
- 6 Press the **Press to Recall** softkey.  
A message indicating whether the recall was successful is displayed.
- 7 If you would like to clear the display of everything except the reference waveform, press **Clear Display**.

## Recalling Default Setups

- 1 Press the **[Save/Recall]** key.
- 2 In the Save/Recall menu, press **Default/Erase**.
- 3 In the Default menu, press one of these softkeys:
  - **Default Setup**— recalls the oscilloscope's default setup. This is the same as pressing the front panel **[Default Setup]** key. See "**Recall the Default Oscilloscope Setup**" on page 24.  
Some user settings are not changed when recalling the default setup.
  - **Factory Default**— recalls the oscilloscope's factory default settings.  
You must confirm the recall because there are no user settings that are left unchanged.

## Performing a Secure Erase

- 1 Press the **[Save/Recall]** key.
- 2 In the Save/Recall menu, press **Default/Erase**.

**3** In the Default menu, press **Secure Erase**.

This performs a secure erase of all non-volatile memory in compliance with National Industrial Security Program Operation Manual (NISPOM) Chapter 8 requirements.

You must confirm the secure erase, and the oscilloscope will reboot when finished.



# 21 Print (Screens)

- To print the oscilloscope's display / 229
- To set up network printer connections / 231
- To specify the print options / 232
- To specify the palette option / 232

You can print the complete display, including the status line and softkeys, to a USB printer or a network printer when the oscilloscope is set up on a network.

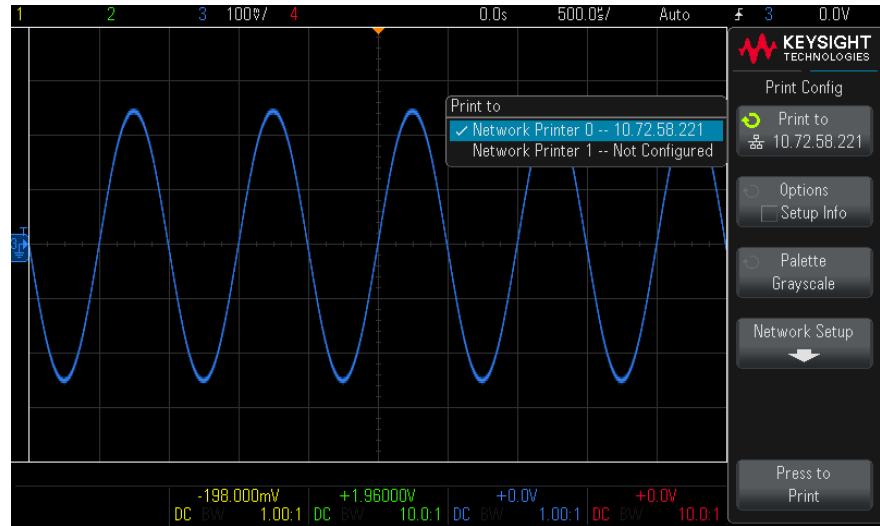
## To print the oscilloscope's display

- 1 Connect a printer. You can:
  - Connect a USB printer to the rectangular USB host port on the front panel.  
For the most up-to-date information on printers that are compatible with the InfiniiVision oscilloscopes, please visit [www.keysight.com/find/InfiniiVision-printers](http://www.keysight.com/find/InfiniiVision-printers).
  - Set up a network printer connection. See "**To set up network printer connections**" on page 231.
- 2 To open the Print Config menu:
  - Press **[Save/Recall] > Print**.
  - Select the **Quick Print** quick action (**[Utility] > Quick Action > Action, Quick Print**); then, press **Settings**.

Some softkeys in the Print Config menu are ghosted (not available) until a printer is connected.

- 3 In the Print Config menu, press the **Print to** softkey; then, turn the Entry knob to select the desired printer.

- 4 Press the **Options** softkey to select the print options.



See ["To specify the print options"](#) on page 232.

- 5 Press the **Palette** softkey to select the print palette. See ["To specify the palette option"](#) on page 232.
- 6 Press the **Press to Print** softkey.

You can stop printing by pressing the **Cancel Print** softkey.

## NOTE

The oscilloscope will print the last menu visited before you opened the Print Config menu. Therefore, if you have measurements (Amplitude, Frequency, etc.) showing on the display before you open the Print Config menu, the measurements will be shown on the printout.

To print the display showing the Print Config menu at the bottom, open the Print Config menu twice; then, press the **Press to Print** softkey.

You can also configure the **[Quick Action]** key to print the display. See ["Configuring the \[Quick Action\] Key"](#) on page 248.

See Also · ["To add an annotation"](#) on page 87

## To set up network printer connections

You can set up network printer connections. A *network printer* is a printer attached to the network or a print server on the network.

- 1 Press [**Save/Recall**] > **Print**.
- 2 In the Print Config menu, press the **Print to** softkey; then, turn the Entry knob to select the network printer you want to configure (either #0 or #1).
- 3 Press the **Network Setup** softkey.
- 4 In the Network Printer Setup menu, press the **Modify** softkey; then, turn the Entry knob to select the network parameter you want to enter.

The setting that must be entered is:

- **Printer Address** – this is the printer or print server's address in one of the following formats:
    - IP address of a network-enabled printer (for example: 192.168.1.100 or 192.168.1.100:650). Optionally, a non-standard port number can be specified following a colon.
    - IP address of a print server followed by the path to the printer (for example: 192.168.1.100/printers/printer-name or 192.168.1.100:650/printers/printer-name).
- 5 Use the **Spell**, **Enter**, and **Delete Character** softkeys to enter the network printer settings:
    - **Spell** – press this softkey and turn the entry knob to select the character at the current position.
    - **Enter** – press this softkey to enter characters and move the cursor to the next character position.
    - **Delete Character** – press the **Enter** softkey until the desired character is highlighted; then, press this softkey to delete the character.

### NOTE

You can use a connected USB keyboard instead of using the **Spell** (and other) character editing softkeys.

- 6 Press the **Apply** softkey to make the printer connection.

A message appears to tell you whether the connection was successful.

## To specify the print options

In the Print Config menu, press the **Options** softkey to change the following options:

- **Setup Information** – Select this to print oscilloscope setup information on your printout, including vertical, horizontal, trigger, acquisition, math, and display settings.
- **Invert Graticule Colors** – Select this to reduce the amount of black ink it takes to print oscilloscope images by changing the black background to white. **Invert Graticule Colors** is the default mode.
- **Form Feed** – Select this to send a form feed command to the printer after the waveform is printed and before the setup information is printed. Switch **Form Feed** off if you want setup information printed on the same sheet of paper with the waveform. This option only has an effect when the **Setup Information** option is selected. Also, if the amount of setup information will not fit on the same page with the waveform, it will be printed on a new page regardless of the **Form Feed** setting.
- **Landscape** – Select this to print horizontally on the page instead of vertically (portrait mode).

## To specify the palette option

In the Print Config menu, press the **Palette** softkey to change the following options.

- **Color** – Select this to print the screen in color.  
The oscilloscope's print driver cannot print color images to color laser printers, so the **Color** option is not available when connected to laser printers.
- **Grayscale** – Select this to print the screen in shades of gray rather than in color.



## 22 Utility Settings

I/O Interface Settings /	233
Setting up the Oscilloscope's LAN Connection /	234
File Explorer /	236
Setting Oscilloscope Preferences /	238
Setting the Oscilloscope's Clock /	242
Setting the Gen Out Source /	242
Enabling Remote Command Logging /	243
Performing Service Tasks /	245
Configuring the [Quick Action] Key /	248

This chapter explains oscilloscope utility functions.

### I/O Interface Settings

The oscilloscope can be accessed and/or controlled remotely via these I/O interfaces:

- USB device port on the rear panel (square shaped USB port).

Connect the USB device port to a computer only when the oscilloscope is turned off or when the oscilloscope is fully booted up and running. If you make this connection while the oscilloscope is booting up, you will likely get a "USB device not recognized" error.

- LAN interface on the rear panel.

To configure the I/O interfaces:

- 1 On the oscilloscope's front panel, press **[Utility]**.

- 2 In the Utility menu, press **I/O**.
- 3 In the I/O menu, press **Configure**.
  - **LAN** – When connected to a LAN, you can use the **LAN Settings** and **LAN Reset** softkeys to configure the LAN interface. See "**Setting up the Oscilloscope's LAN Connection**" on page 234.
  - **USB** – You can enable **Compatibility Mode** if you are experiencing connectivity issues when using the oscilloscope as a USB device. This mode provides maximum compatibility with USB host controllers at the cost of I/O performance.

When an I/O interface is present, remote control over that interface is always enabled. Also, the oscilloscope can be controlled via multiple I/O interfaces (for example, USB and LAN) at the same time.

- See Also**
- **Chapter 23**, "Web Interface," starting on page 251 (when the oscilloscope is connected to a LAN).
  - The oscilloscope's *Programmer's Guide*.

## Setting up the Oscilloscope's LAN Connection

You can place the oscilloscope on the network and set up its LAN connection. Once that is done, you can use the oscilloscope's web interface or remotely control the oscilloscope via the LAN interface.

The oscilloscope supports methods for automated LAN configuration or manual LAN configuration (see "**To establish a LAN connection**" on page 235). It is also possible to set up a point-to-point LAN connection between a PC and the oscilloscope (see "**Stand-alone (Point-to-Point) Connection to a PC**" on page 236).

Once the oscilloscope is set up on the network, you can use the oscilloscope's web page to view or change its network configuration and access additional settings (like the network password). See **Chapter 23**, "Web Interface," starting on page 251.

### NOTE

Any time you modify the oscilloscope's hostname, it breaks the connection between the oscilloscope and the LAN. You need to re-establish communication to the oscilloscope using the new hostname.

## To establish a LAN connection

- Automatic Configuration**
- 1 Press **[Utility] > I/O**.
  - 2 Press the **LAN Settings** softkey.
  - 3 Press the **Config** softkey; then, turn the Entry knob to select **Automatic**, and press the softkey again to enable it.
 

If your network supports DHCP or AutoIP, enabling **Automatic** lets the oscilloscope use those services to get its LAN configuration settings
  - 4 You can enable the **Multicast DNS** option to let the oscilloscope use Multicast DNS for name resolution on small networks without a conventional DNS server.
  - 5 Connect the oscilloscope to the local area network (LAN) by inserting the LAN cable into the "LAN" port on the rear panel of the oscilloscope.
 

In a few moments the oscilloscope will connect to the network automatically.

If the oscilloscope does not automatically connect to the network, press **[Utility] > I/O > LAN Reset**. In a few moments the oscilloscope will connect to the network.
- Manual Configuration**
- 1 Get the oscilloscope's network parameters (host name, IP address, subnet mask, gateway IP, DNS IP, etc.) from your network administrator.
  - 2 Press **[Utility] > I/O**.
  - 3 Press the **LAN Settings** softkey.
  - 4 Press the **Config** softkey; then, turn the Entry knob to select **Automatic**, and press the softkey again to disable it.
 

If Automatic is not enabled, the oscilloscope's LAN configuration must be set up manually using the **Addresses** and **Host name** softkeys
  - 5 Configure the oscilloscope's LAN interface:
    - a Press the **Addresses** softkey.
    - b Use the **Modify** softkey (and the other softkeys and the Entry knob) to enter the IP Address, Subnet Mask, Gateway IP, and DNS IP values. When you are done, go back up in the menu hierarchy.
    - c Press the **Host name** softkey. Use the softkeys and the Entry knob to enter the Host name. When you are done, go back up in the menu hierarchy.
    - d Press the **Apply** softkey.
  - 6 Connect the oscilloscope to the local area network (LAN) by inserting the LAN cable into the "LAN" port on the rear panel of the oscilloscope.

## Stand-alone (Point-to-Point) Connection to a PC

The following procedure describes how to establish a point-to-point (stand alone) connection to the oscilloscope. This is useful if you want to control the oscilloscope using a laptop computer or a stand-alone computer.

- 1 Press **[Utility] > I/O**.
- 2 Press the **LAN Settings** softkey.
- 3 Press the **Config** softkey; then, turn the Entry knob to select **Automatic**, and press the softkey again to enable it.

If your network supports DHCP or AutoIP, enabling **Automatic** lets the oscilloscope use those services to get its LAN configuration settings

- 4 Connect your PC to the oscilloscope using a cross-over LAN cable such as Keysight part number 5061-0701, available on the web at [www.keysight.com/find/parts](http://www.keysight.com/find/parts).
- 5 Cycle power on the oscilloscope. Wait until the LAN connection is configured:
  - Press **[Utility] > I/O** and wait until the LAN status shows "configured".

This may take a few minutes.

Now, the instrument is connected, and the instrument's web interface or remote control via LAN may be used.

## File Explorer

The File Explorer lets you navigate the oscilloscope's internal file system and the file systems of connected USB storage devices.

From the internal file system, you can load oscilloscope setup files or mask files.

From a connected USB storage device, you can load setup files, mask files, license files, firmware update (\*.cab) files, label files, etc. Also, you can delete files on a connected USB storage device.

### NOTE

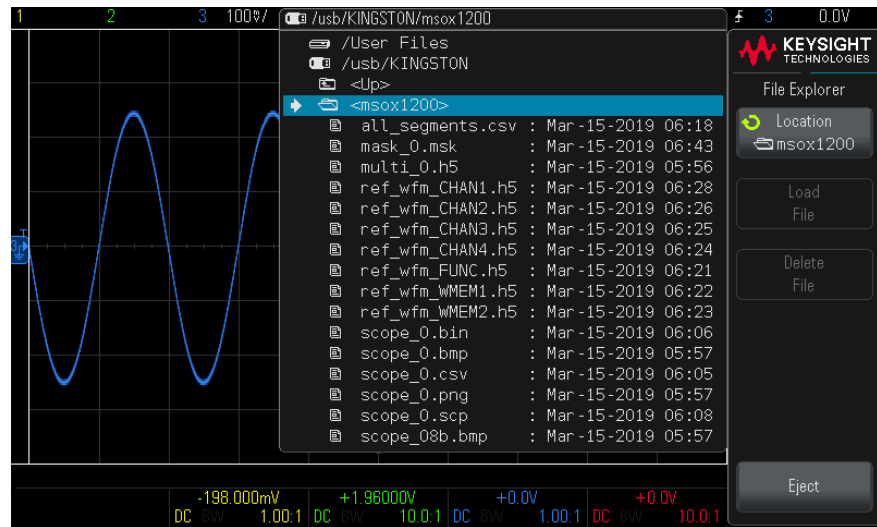
The rectangular USB port on the front panel is a USB Series A receptacle to which you can connect USB mass storage devices and printers.

The square receptacle on the rear panel labeled "DEVICE" is provided for controlling the oscilloscope over USB. See the *Programmer's Guide* for more information.

The oscilloscope's internal file system, under "/User Files", consists of 10 locations for oscilloscope setup files, and four locations for mask files.

To use the File Explorer:

- 1 Press **[Utility] > File Explorer**.
- 2 In the File Explorer menu, press the softkey in the first position and use the Entry knob to navigate.



The softkey in the first position can have these labels:

- **Press to go** – when you can push the Entry knob to navigate to a new folder or storage location.
- **Location** – when pointing to a directory that is currently selected.
- **Selected** – when pointing to a file that can be loaded or deleted.

When this label appears, you can press the **Load File** or **Delete File** softkeys to take the action.

Pushing the Entry knob is the same as pressing the **Load File** softkey.

A file that has been deleted from a USB storage device cannot be recovered by the oscilloscope.

- **Eject** – press this softkey to properly unmount a USB storage device before removal.

If you remove the device without pressing the **Eject** softkey first, the device will be marked as needing repair when connecting to a computer with the Windows operating system (even though there are no harmful effects to the device).

### USB Storage Devices

Use your PC to create directories on a USB storage device.

Most USB mass storage devices are compatible with the oscilloscope. However, certain devices may be incompatible, and may not be able to be read or written to. USB storage devices must be formatted with the FAT/FAT16, FAT32, NTFS, EXT2, EXT3, or EXT4 file system format. The exFAT format is not supported. Any given storage device may not support all of these formats.

When the USB mass storage device is connected to the oscilloscope's USB host port, a small four-color circle icon may be displayed briefly as the USB storage device is read.

You must "eject" a USB mass storage device before unplugging it; otherwise, the device will be marked as needing repair when connecting to a computer with the Windows operating system (even though there are no harmful effects to the device).

Do not connect USB storage devices that identify themselves as hardware type "CD" because these devices are not compatible with the InfiniiVision X-Series oscilloscopes.

**See Also** • **Chapter 20**, "Save/Recall (Setups, Screens, Data)," starting on page 217

## Setting Oscilloscope Preferences

The User Preferences menu (under **[Utility] > Options > Preferences**) lets you specify oscilloscope preferences.

- **"To choose "expand about" center or ground"** on page 239
- **"To disable/enable transparent backgrounds"** on page 239
- **"To load the default label library"** on page 239
- **"To set up the screen saver"** on page 239
- **"To set Autoscale preferences"** on page 241

## To choose "expand about" center or ground

When you change a channel's volts/division setting, the waveform display can be set to expand (or compress) about the signal ground level or the center of the display.

To set the waveform expansion reference point:

**1** Press **[Utility] > Options > Preferences > Expand** and select:

- **Ground**— The displayed waveform will expand about the position of the channel's ground. This is the default setting.

The ground level of the signal is identified by the position of the ground level (⚡) icon at the far-left side of the display.

The ground level will not move when you adjust the vertical sensitivity (volts/division) control.

If the ground level is off screen, the waveform will expand about the top or bottom edge of the screen based on where the ground is off screen.

- **Center**— The displayed waveform will expand about the center of the display.

## To disable/enable transparent backgrounds

There is a preference setting for whether measurements, statistics, reference waveform information, and other text displays have transparent or solid backgrounds.

**1** Press **[Utility] > Options > Preferences**.

**2** Press **Transparent** to toggle between transparent and solid text display backgrounds.

## To load the default label library

See "[To reset the label library to the factory default](#)" on page 95.

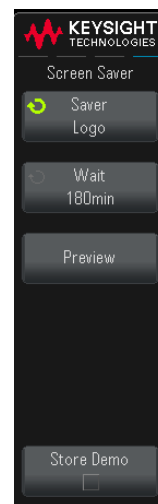
## To set up the screen saver

The oscilloscope can be configured to turn on a display screen saver when the oscilloscope has been idle for a specified length of time.

- 1 Press **[Utility] > Options > Preferences > Screen Saver** to display the Screen Saver menu.
- 2 Press the **Saver** softkey to select the screen saver type.

The screen saver can be set to **Off**, to display any of the images shown in the list, or can display a user-defined text string.

If **User** is selected, press the **Spell** softkey to select the first character of the text string. Use the Entry knob to choose a character. Then press the **Enter** softkey to advance to the next character and repeat the process.



#### NOTE

You can use a connected USB keyboard instead of using the **Spell** (and other) character editing softkeys.

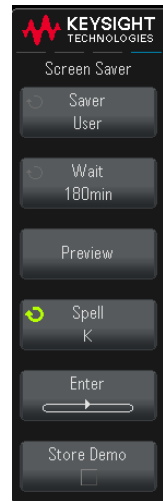


The resultant string is displayed in the "Text =" line.

- 3 Press the **Wait** softkey; then, turn the Entry knob to select the number of minutes to wait before the selected screen saver activates.

When you turn the Entry knob, the number of minutes is displayed on the **Wait** softkey. The default time is 180 minutes (3 hours).

- 4 Press the **Preview** softkey to preview the screen saver you have selected with the **Saver** softkey.
- 5 To view the normal display after the screen saver has started, press any key or turn any knob.



## To set Autoscale preferences

- 1 Press **[Utility] > Options > Preferences > Autoscale**.
- 2 In the Autoscale Pref menu, you can:
  - Press the **Fast Debug** softkey enable/disable this type of autoscale.

When fast debug is enabled, autoscale lets you make quick visual comparisons to determine whether the signal being probed is a DC voltage, ground, or an active AC signal.

Channel coupling is maintained to allow easy viewing of oscillating signals.

- Press the **Channels** softkey and turn the Entry knob to specify the channels to be autoscaled:
  - **All Channels** – The next time you press **[Auto Scale]**, all channels that meet the requirements of Autoscale will be displayed.
  - **Only Displayed Channels** – The next time you press **[Auto Scale]**, only the channels that are turned on will be examined for signal activity. This is useful if you only want to view specific active channels after pressing **[Auto Scale]**.
- Press the **Acq Mode** softkey and turn the Entry knob to select whether the acquisition mode should be preserved during autoscale:

- **Normal** – to make the oscilloscope switch to Normal acquisition mode whenever the **[Auto Scale]** key is pressed. This is the default mode.
- **Preserve** – to make the oscilloscope remain in the acquisition mode you have chosen when the **[Auto Scale]** key is pressed.

## Setting the Oscilloscope's Clock

The Clock menu lets you set the current date and time of day (24-hour format). This time/date stamp will appear on hardcopy prints and directory information on the USB mass storage device.

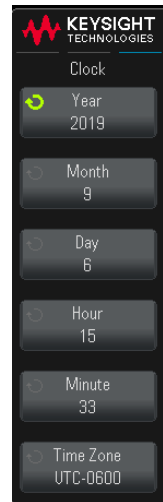
To set the date and time, or to view the current date and time:

- 1 Press **[Utility] > Options > Clock**.
- 2 Press the **Year, Month, Day, Hour** or **Minute** softkey; then, rotate the Entry knob to set to the appropriate number.
- 3 Press the **Time Zone** softkey; then, rotate the Entry knob to select your time zone.

Because licenses are based on Coordinated Universal Time (UTC), the proper time zone setting allows licenses to work immediately after they are generated.

The hours are shown in the 24-hour format. So 1:00 PM is hour 13.

The real-time clock allows selection of valid dates only. If a day is selected and the month or year is changed so the day is invalid, the day is automatically adjusted.



## Setting the Gen Out Source

On G-suffix oscilloscope models (that have a built-in waveform generator), you can choose the source of the Gen Out connector on the front panel of the oscilloscope:

- 1 Press **[Utility] > Options > Auxiliary**.
- 2 In the Auxiliary menu, press **Gen Out**; then, turn the Entry knob to select from:
  - **WaveGen**— The waveform generator output. See **Chapter 19**, “Waveform Generator,” starting on page 205.
  - **Triggers**— The trigger output. Each time the oscilloscope triggers, a rising edge occurs. The signal is 0–5 V. See **Chapter 11**, “Triggers,” starting on page 97.
  - **Mask**— The mask test failure output. A 5 volt pulse occurs when the mask test fails. When the mask test passes, no pulse occurs, and the signal remains at 0 volts. See **Chapter 16**, “Mask Testing,” starting on page 181.

The output impedance of the Gen Out connector is 50 ohms.

## Enabling Remote Command Logging

When remote command logging is enabled, remote commands sent to the instrument (and results returned by the instrument) can be logged to the screen, to a text file on a USB storage device, or to both the screen and a text file.

To enable remote command logging:

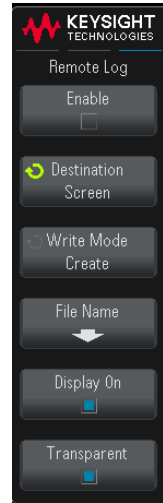
1 Press **[Utility] > Options > Remote Log** to open the Remote Log menu:

2 Press **Enable** to enable or disable the remote command logging feature.

When remote logging is enabled, additional debug information can be included in the returned error string. If the error is detected by the SCPI command parser, such as a header error or other syntax error, the extra debug information is generated and included. But if the error is detected by the oscilloscope system, such as when an out-of-range value is sent, then no extra debug information is included.

3 Press **Destination** to select whether remote commands are logged to a text file (on a connected USB storage device), logged to the screen, or both.

4 Press **Write Mode** to specify whether logged commands will be created in a new list or appended to existing logged commands.



Your selection takes effect when remote command logging is enabled.

This option applies to both screen and file logging.

5 Press **File Name** to open the Log Filename menu where you can specify the name of the file (on the USB storage device) to which remote commands are logged.

6 Press **Display On** to enable or disable the screen display of logged remote commands and their return values (if applicable).

7 Press **Transparent** to disable or enable a transparent background for the remote command logging screen display.

Enable to make the background transparent. This lets you view underlying waveforms.

Disable for a solid background which makes the logged remote commands easier to read.

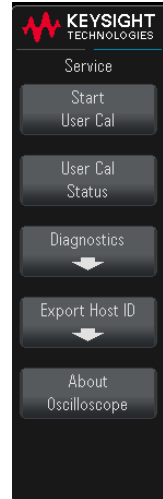
## Performing Service Tasks

The Service menu (under **[Utility] > Service**) lets you perform service-related tasks:

- "To perform user calibration" on page 245
- "To perform hardware self test" on page 246
- "To perform front panel self test" on page 246
- "To export crash log files" on page 246
- "To display oscilloscope information" on page 247
- "To display the user calibration status" on page 247

For other information related to oscilloscope maintenance and service, see:

- "To clean the oscilloscope" on page 247
- "To check warranty and extended services status" on page 247
- "To contact Keysight" on page 248
- "To return the instrument" on page 248



### To perform user calibration

User Calibration performs an internal self-alignment routine to optimize the signal path in the oscilloscope. The routine uses internally generated signals to optimize circuits that affect channel sensitivity, offset, and trigger parameters.

User Cal should be performed:

- Every five years or after 10000 hours of operation.
- When the ambient temperature of the oscilloscope is >10 °C different than when the last User Cal was performed.
- When you want to maximize the measurement accuracy.

Performing User Cal will invalidate your Certificate of Calibration. If NIST (National Institute of Standards and Technology) traceability is required, perform the "Performance Verification" procedure in the *Keysight InfiniiVision 1200 X-Series Oscilloscopes Service Guide* using traceable sources.

To perform user calibration:

- 1 Disconnect all inputs and waveform generator output (if available). No cables are needed. Allow the oscilloscope to warm up before performing this procedure.
- 2 Disable user calibration protection by pressing **[Utility] > Options > Auxiliary > Cal Protect**.
- 3 Press **[Utility] > Service**.
- 4 In the Service menu, begin the user calibration by pressing the **Start User Cal** softkey.

### To perform hardware self test

Pressing **[Utility] > Service > Diagnostics > Hardware Self Test** performs a series of internal procedures to verify that the oscilloscope is operating properly.

It is recommended you run Hardware Self Test:

- After experiencing abnormal operation.
- For additional information to better describe an oscilloscope failure.
- To verify proper operation after the oscilloscope has been repaired.

Successfully passing Hardware Self Test does not guarantee 100% of the oscilloscope's functionality. Hardware Self Test is designed to provide an 80% confidence level that the oscilloscope is operating properly.

### To perform front panel self test

Pressing **[Utility] > Service > Diagnostics > Front Panel Self Test** lets you test the front panel keys and knobs as well as the oscilloscope display.

Follow the on-screen instructions.

### To export crash log files

Pressing **[Utility] > Service > Diagnostics > Export Logs** opens the Log Export menu where you can save crash log files to a connected USB storage device.

Crash log files are used by Keysight Technical Support when debugging oscilloscope problems.

When there is no crash log data available to export, this softkey is ghosted (unavailable).

A secure erase (see "**Performing a Secure Erase**" on page 226) will remove crash log data along with other non-volatile memory.

### To display oscilloscope information

Press **[Help] > About Oscilloscope** to display information about your oscilloscope:

- Model number.
- Serial number.
- Bandwidth.
- Host ID.
- Software version.
- Installed licenses.

### To display the user calibration status

Pressing **[Utility] > Service > User Cal Status** displays the summary results of the previous User Cal, and the status of probe calibrations for probes that can be calibrated. Note that passive probes do not need to be calibrated.

```
Results:
User Cal date:
Change in temperature since last User Cal:
Failure:
Comments:
Probe Cal Status:
```

### To clean the oscilloscope

- 1 Remove power from the instrument.
- 2 Clean the external surfaces of the oscilloscope with a soft cloth dampened with a mixture of mild detergent and water.
- 3 Make sure that the instrument is completely dry before reconnecting it to a power source.

### To check warranty and extended services status

To learn the warranty status of your oscilloscope:

- 1 Point your web browser to: [www.keysight.com/find/warrantystatus](http://www.keysight.com/find/warrantystatus)
- 2 Enter your product's model number and serial number. The system will search for the warranty status of your product and display the results. If the system

cannot find your product's warranty status, select **Contact Us** and speak with a Keysight Technologies representative.

### To contact Keysight

Information on contacting Keysight Technologies can be found at:  
[www.keysight.com/find/contactus](http://www.keysight.com/find/contactus)

### To return the instrument

Before shipping the oscilloscope to Keysight Technologies, contact your nearest Keysight Technologies sales or service office for additional details. Information on contacting Keysight Technologies can be found at:

[www.keysight.com/find/contactus](http://www.keysight.com/find/contactus)

- 1 Write the following information on a tag and attach it to the oscilloscope.
  - Name and address of owner.
  - Model number.
  - Serial number.
  - Description of service required or failure indication.
- 2 Remove accessories from the oscilloscope.

Only return accessories to Keysight Technologies if they are associated with the failure symptoms.
- 3 Package the oscilloscope.

You can use the original shipping container, or provide your own materials sufficient to protect the instrument during shipping.
- 4 Seal the shipping container securely, and mark it FRAGILE.

## Configuring the [Quick Action] Key

The **[Quick Action]** key lets you perform common, repetitive actions by pressing a single key.

To configure the **[Quick Action]** key:

- 1 Press **[Utility] > Quick Action > Action**; then, select the action that should be performed:



- **Off** – disables the **[Quick Action]** key.
- **Quick Measure All** – displays a popup containing a snapshot of all the single waveform measurements. The **Source** softkey lets you select the waveform source (which also becomes the source selection in the Measurement menu). See **Chapter 15**, “Measurements,” starting on page 155.
- **Quick Mask Statistics Reset** – resets mask testing statistics. For more information, see **"Mask Statistics"** on page 186.
- **Quick Print** – prints the current screen image. Press **Settings** to set up the printing options. See **Chapter 21**, “Print (Screens),” starting on page 229.
- **Quick Save** – saves the current image, waveform data, or setup. Press **Settings** to set up the save options. See **Chapter 20**, “Save/Recall (Setups, Screens, Data),” starting on page 217.
- **Quick Recall** – recalls a setup, mask, or reference waveform. Press **Settings** to set up the recall options. See **Chapter 20**, “Save/Recall (Setups, Screens, Data),” starting on page 217.
- **Quick Freeze Display** – freezes the display without stopping running acquisitions or un-freezes the display if currently frozen. For more information, see **"To freeze the display"** on page 89.
- **Quick Trigger Mode** – toggles the trigger mode between Auto and Normal, see **"To select the Auto or Normal trigger mode"** on page 122.
- **Quick Clear Display** – clears the display, see **"To clear the display"** on page 86.

Once the **[Quick Action]** key is configured, you simply press it to perform the selected action.



## 23 Web Interface

Accessing the Web Interface / 252

Control Instrument / 253

Get Image / 256

Save/Recall / 257

Identification Function / 259

Instrument Utilities / 260

Setting a Password / 261

When Keysight InfiniiVision 1200 X-Series and EDUX1052A/G oscilloscopes are set up on the LAN, you can access the oscilloscope's built-in web server using a web browser. The oscilloscope's web interface lets you:

- View information about the oscilloscope like its model number, serial number, host name, IP address, and VISA (address) connect string.
- Control the oscilloscope using the Remote Front Panel.
- Send SCPI (Standard Commands for Programmable Instrumentation) remote programming commands via the SCPI Commands applet window.
- Get screen images and save or print them from the browser.
- Save setups, screen images, waveform data, and mask files.
- Recall setup files, reference waveform data files, or mask files.
- Activate the Identification function to identify a particular instrument by causing a message to be displayed or a front panel light to blink.
- View installed options, firmware versions, and calibration status (via the Instrument Utilities page).
- View and modify the oscilloscope's network configuration.

The web interface for InfiniiVision X-Series oscilloscopes also provides help for each of its pages.

Before you can use the web interface, you must place the oscilloscope on the network and set up its LAN connection.

## Accessing the Web Interface


To access the oscilloscope's web interface:

- 1 Connect the oscilloscope to your LAN (see **"To establish a LAN connection"** on page 235) or establish a point-to-point connection (see **"Stand-alone (Point-to-Point) Connection to a PC"** on page 236).


It is possible to use a point-to-point connection, but using a normal LAN connection is the preferred method.

- 2 Type the oscilloscope's hostname or IP address in the web browser.


The oscilloscope's web interface Welcome Page is displayed.




**DSOX1204G Oscilloscope**  
Serial number: CN58027117

Log in 


---

Home
Control Instrument
Get Image
Instrument Utilities
Configure LAN 



Enable front panel identification indicator

Connected to DSOX1204G Oscilloscope  
at IP address 141.121.229.200



---

**Description**

Model number	DSOX1204G
Manufacturer	Keysight Technologies
Serial number	CN58027117
Firmware revision	01.99.2018082531
Description	Keysight InfiniiVision Oscilloscope 0 - 0

**VISA instrument addresses**

HiSLIP LAN protocol	TCPIP::141.121.229.200::hislip0::INSTR
TCP/IP SOCKET protocol	TCPIP::141.121.229.200::5025::SOCKET
TCP/IP TELNET protocol	TCPIP::141.121.229.200::5024::SOCKET
USB (USBTMC/488)	USB0::10893::918::CN58027117::0::INSTR

**▼ More Information**

© Keysight Technologies 2006 - 2018
Support
Product
Keysight

## Control Instrument

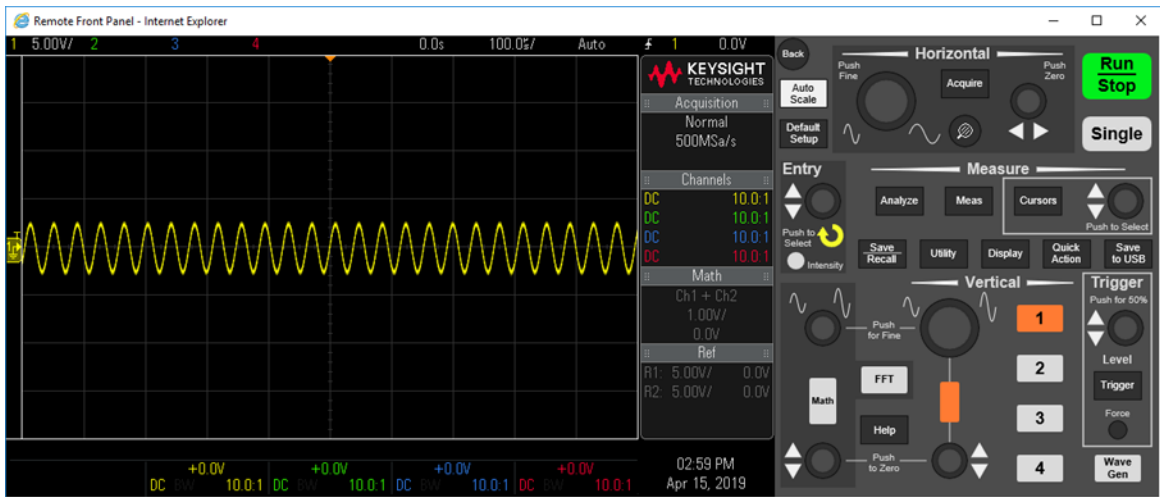
The web interface's Browser Web Control page gives you access to:

- The Browser-Based Remote Front Panel (see **"Remote Front Panel"** on page 254).
- The SCPI Command window applet for Remote Programming (see **"Remote Programming via the Web Interface"** on page 254).

## Remote Front Panel

To operate the oscilloscope using the web interface's browser-based Remote Front Panel:

- 1 Access the oscilloscope's web interface (see "[Accessing the Web Interface](#)" on page 252).
- 2 When the oscilloscope's web interface is displayed, select **Control Instrument**, then select **Use Remote Front Panel**. After a few seconds the Remote Front Panel appears.
- 3 Click keys or knobs that you would normally press on the oscilloscope's front panel. Buttons have been added for turning knobs.



## Remote Programming via the Web Interface

### NOTE

If Java is not installed on your PC, you will be prompted to install the Java Plug-in. This plug-in must be installed on the controlling PC for the web interface's Remote Programming operations.

The SCPI Command window is useful for testing commands or entering a few commands interactively. When creating automated programs for controlling the oscilloscope, you will typically use the Keysight IO Libraries from within a programming environment like Microsoft Visual Studio (see "[Remote Programming with Keysight IO Libraries](#)" on page 256).

To send remote programming commands to the oscilloscope via the SCPI Commands applet window:

- 1 Access the oscilloscope's web interface (see "[Accessing the Web Interface](#)" on page 252).
- 2 When the oscilloscope's web interface is displayed, select the **Control Instrument** tab, then select **Use Instrument IO**.

The SCPI Commands applet appears within the browser web page.

The screenshot displays the Keysight DSOX1204G Oscilloscope web interface. At the top, the logo and model name are shown, along with the serial number CN58027117. A navigation bar includes links for Home, Control Instrument, Get Image, Save, Recall, Instrument Utilities, and Configure LAN. The main content area is titled "Instrument IO" and contains the following elements:

- A description: "Send remote programming (SCPI) commands and queries to the instrument and view the responses returned by the instrument."
- A "Command" section with a text input field containing "\*IDN?", an "Execute" button, and a "Commands" dropdown menu.
- A "Response history" section with a scrollable area showing the following text:
 

```
SENT: *IDN?
READ: KEYSIGHT TECHNOLOGIES,DSOX1204G,CN58027117,02.10.2019090631
-----
```
- Buttons for "Device clear", "Copy history", and "Clear history".
- An "Options" section with a dropdown arrow.

The footer contains copyright information: © Keysight Technologies 2006 - 2019 | Support | Product | Keysight

## Remote Programming with Keysight IO Libraries

While the SCPI Commands applet window lets you enter and remote programming commands, remote programming for automated test and data acquisition is typically done using the Keysight IO Libraries, which are separate from the instrument's web interface.

The Keysight IO Libraries let a controller PC communicate with Keysight InfiniiVision X-Series oscilloscopes via their USB, LAN, or GPIB interfaces (if available).

The Keysight IO Libraries Suite connectivity software to enables communication over these interfaces. You can download the Keysight IO Libraries Suite from [www.keysight.com/find/iolib](http://www.keysight.com/find/iolib).

Information about controlling the oscilloscope through remote commands is contained in the *Programmer's Guide*. You can access this document on the Keysight web site.

For more information about connecting to the oscilloscope, refer to the *Keysight Technologies USB/LAN/GPIB Interfaces Connectivity Guide*. For a printable electronic copy of the *Connectivity Guide*, direct your Web browser to [www.keysight.com](http://www.keysight.com) and search for "Connectivity Guide".

## Get Image

To save (or print) the oscilloscope's display from the web interface:

- 1 Access the oscilloscope's web interface (see "[Accessing the Web Interface](#)" on page 252).
- 2 When the oscilloscope's web interface is displayed, select the **Get Image** tab from the left side of the Welcome screen. After a delay of several seconds, the oscilloscope's screen image will be displayed.
- 3 Right-click on the image and select **Save Picture As...** (or **Print Picture...**).
- 4 Select a storage location for the image file and click **Save**.



## Save/Recall

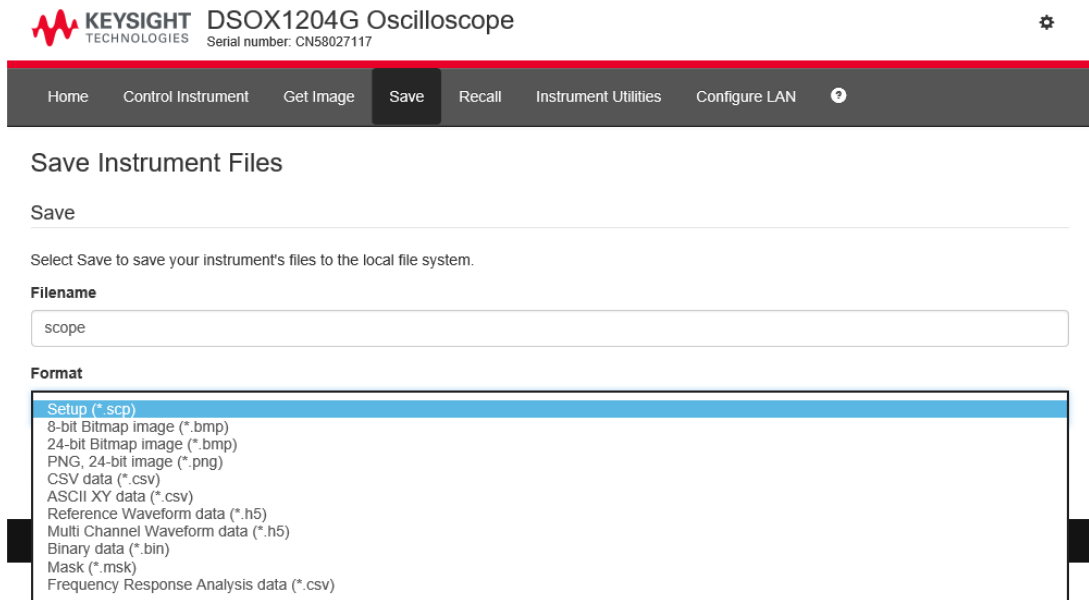
You can save setup files, screen images, waveform data files, or mask files to your PC via the oscilloscope's web interface (see "[Saving Files via the Web Interface](#)" on page 257).

You can recall setup files, reference waveform data files, or mask files from your PC via the oscilloscope's web interface (see "[Recalling Files via the Web Interface](#)" on page 258).

### Saving Files via the Web Interface

To save setup files, screen images, waveform data, Lister data, or mask files to your PC via the oscilloscope's web interface:

- 1** Access the oscilloscope's web interface (see "[Accessing the Web Interface](#)" on page 252).
- 2** When the oscilloscope's web interface is displayed, select the **Save** tab.
- 3** On the Save page:
  - a** Enter the name of the file you are saving to.
  - b** Select the format.



You can click **Preview** to view the oscilloscope's current screen image.

With some formats, you can click **Save Setup Info** to save setup information to an ASCII .txt format file.

**c** Click **Save**.

The current acquisition is saved.

**d** In the File Download dialog, click **Save**.

**e** In the Save As dialog, navigate to the folder where you want to save the file; then, click **Save**.

## Recalling Files via the Web Interface

To recall setup files, reference waveform data files, or mask files from your PC via the oscilloscope's web interface:

- 1 Access the oscilloscope's web interface (see "[Accessing the Web Interface](#)" on page 252).
- 2 When the oscilloscope's web interface is displayed, select the **Recall** tab.

- 3 On the Recall page:
  - a Click **Browse...**
  - b In the "Choose file" dialog, select the file you want to recall; then, click **Open**.
  - c When recalling reference waveform data files, select the **Recall to Reference Waveform** option.

KEYSIGHT TECHNOLOGIES DSOX1204G Oscilloscope  
Serial number: CN58027117

Home Control Instrument Get Image Save **Recall** Instrument Utilities Configure LAN

## Recall Instrument Files

Recall

Select Recall to recall previously saved files to your instrument.

**Filename**

C:\Temp\web\_interface\scope.h5

**Recall to Reference Waveform**

R1

© Keysight Technologies 2006 - 2019 | [Support](#) | [Product](#) | [Keysight](#)

- d Click **Recall**.

## Identification Function

The Identification web interface feature is useful when trying to locate a specific instrument in a rack of equipment.

- 1 Access the oscilloscope's web interface (see "[Accessing the Web Interface](#)" on page 252).
- 2 When the oscilloscope's web interface Home tab is displayed, select the **Enable front panel identification indicator** check box.

An "Identify" message is displayed on the oscilloscope.

You can either clear the **Enable front panel identification indicator** check box or press the **OK** softkey on the oscilloscope to continue.

KEYSIGHT TECHNOLOGIES DSOX1204G Oscilloscope Serial number: CN58027117 Log in ⚙

Home Control Instrument Get Image Instrument Utilities Configure LAN ⓘ

Connected to DSOX1204G Oscilloscope at IP address 141.121.229.6

Enable front panel identification indicator Identification option

## Instrument Utilities

The Instrument Utilities page of the web interface lets you:

- View installed options.
- View firmware versions.
- View calibration status.

You can select these capabilities via a drop-down menu.

KEYSIGHT TECHNOLOGIES DSOX1204G Oscilloscope Serial number: CN58027117 Log in ⚙️

Home Control Instrument Get Image **Instrument Utilities** Configure LAN

### Instrument Utilities

Installed Options		
Firmware Version		
Calibration Status		

Host ID: DSOX1204G,CN58027117,G147ETCDNUZSMYNG

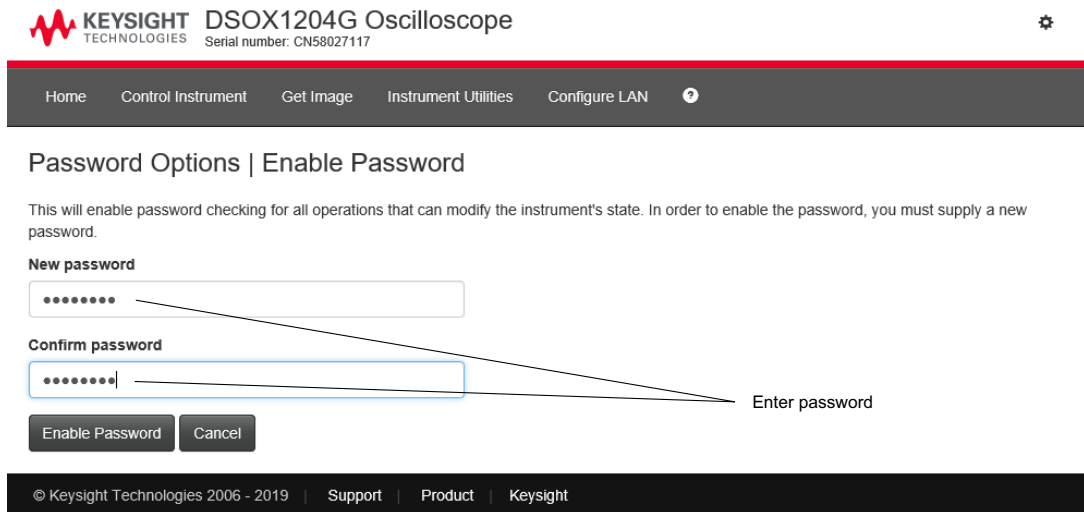
License	Description	Installed
EMBD	Embedded serial decode and trigger	Yes
AUTO	Automotive serial decode and trigger	Yes

## Setting a Password

Whenever you connect the oscilloscope to a LAN, it is good practice to set a password. The password prevents someone from remotely accessing the oscilloscope via a Web browser and modifying its settings. Remote users can still view the Welcome screen, view network status, etc., but they cannot modify instrument settings without the password.

To set a password:

- 1 Access the oscilloscope's web interface (see "[Accessing the Web Interface](#)" on page 252).
- 2 When the oscilloscope's web interface is displayed, select the gear icon in the upper-right corner of the web page.
- 3 Click the **Enable password** button.
- 4 Enter your desired password in the **New Password** field. Enter the password again in the **Confirm Password** field. Click **Enable Password**.



When a password is enabled for the web interface, **Log out** or **Log in** appears in the upper-right corner next to the gear icon.

### To change or disable the password

Do one of these things:

- Select the gear icon in the upper-right corner of the web page. In the Password Options page, click **Change Password** or **Disable Password**.
- Another way to disable the password is to reset the oscilloscope's LAN settings. To do this, select the **Configure LAN** tab, select **Advanced options**, and select **LAN Reset**.
- You can also reset the oscilloscope's LAN settings using the keys on the front panel of the oscilloscope: press **[Utility] > I/O > LAN Reset**.

## 24 Reference

Specifications and Characteristics /	263
Measurement Category /	263
Environmental Conditions /	265
Probes and Accessories /	265
Software and Firmware Updates /	266
Binary Data (.bin) Format /	266
CSV and ASCII XY files /	273
Acknowledgements /	275
Product Markings and Regulatory Information /	275

### Specifications and Characteristics

For up-to-date specifications and characteristics on the 1200 X-Series oscilloscopes, see the data sheet at: [www.keysight.com/find/1200X-Series](http://www.keysight.com/find/1200X-Series)

### Measurement Category

- "[Oscilloscope Measurement Category](#)" on page 263
- "[Measurement Category Definitions](#)" on page 264
- "[Maximum Input Voltages](#)" on page 264

### Oscilloscope Measurement Category

The InfiniiVision oscilloscopes are not intended to be used for measurements in Measurement Category II, III, or IV.

**WARNING**

**Use this instrument only for measurements within its specified measurement category (not rated for CAT II, III, IV). No transient overvoltages allowed.**

---

## Measurement Category Definitions

The "Not rated for CAT II, III, IV" measurement category is for measurements performed on circuits not directly connected to MAINS. Examples are measurements on circuits not derived from MAINS, and specially protected (internal) MAINS derived circuits. In the latter case, transient stresses are variable; for that reason, the transient withstand capability of the equipment is made known to the user.


Measurement category II is for measurements performed on circuits directly connected to the low voltage installation. Examples are measurements on household appliances, portable tools and similar equipment.

Measurement category III is for measurements performed in the building installation. Examples are measurements on distribution boards, circuit-breakers, wiring, including cables, bus-bars, junction boxes, switches, socket-outlets in the fixed installation, and equipment for industrial use and some other equipment, for example, stationary motors with permanent connection to the fixed installation.

Measurement category IV is for measurements performed at the source of the low-voltage installation. Examples are electricity meters and measurements on primary overcurrent protection devices and ripple control units.

## Maximum Input Voltages

**CAUTION**

 **Maximum input voltage at analog inputs**  
150 Vrms, 200 Vpk

---



## Environmental Conditions

Environment	Indoor use only.
Ambient temperature	Operating: 0 °C to +50 °C Non-operating: -10 °C to +70 °C
Humidity	Operating: Up to 95% RH, non-condensing to temperatures up to +40 °C decreasing linearly to 50% RH at +50 °C Non-operating: Up to 90% RH up to +65 °C (non condensing)
Altitude	Operating: to 3,000 m Non-operating to 15,300 m
Overvoltage Category	This product is intended to be powered by MAINS that comply to Overvoltage Category II, which is typical of cord-and-plug connected equipment.
Pollution Degree	The InfiniiVision 1200 X-Series and EDUX1052A/G oscilloscopes may be operated in environments of Pollution Degree 2 (or Pollution Degree 1).
Pollution Degree Definitions	<p>Pollution Degree 1: No pollution or only dry, non-conductive pollution occurs. The pollution has no influence. Example: A clean room or climate controlled office environment.</p> <p>Pollution Degree 2. Normally only dry non-conductive pollution occurs. Occasionally a temporary conductivity caused by condensation may occur. Example: General indoor environment.</p> <p>Pollution Degree 3: Conductive pollution occurs, or dry, non-conductive pollution occurs which becomes conductive due to condensation which is expected. Example: Sheltered outdoor environment.</p>

## Declaration of Conformity

For Declarations of Conformity for Keysight products, go to:  
[www.keysight.com/go/conformity](http://www.keysight.com/go/conformity)

## Probes and Accessories

For a list of the probes and accessories that are compatible with the 1200 X-Series oscilloscopes, see the data sheet at: [www.keysight.com/find/1200X-Series](http://www.keysight.com/find/1200X-Series)

Because the 1200 X-Series oscilloscopes do not have a ring around the BNC connector for identifying probes, you must set the probe attenuation factor manually. See "[Setting Analog Channel Probe Options](#)" on page 51.

- See Also** For more information on probes and accessories, see [www.keysight.com](http://www.keysight.com) for:
- [Probes and Accessories Selection Guide \(5989-6162EN\)](#)
  - [InfiniiVision Oscilloscope Probes and Accessories Selection Guide Data Sheet \(5968-8153EN\)](#)
  - For compatibility information, manuals, application notes, data sheets, selection guides, SPICE models, and more for oscilloscope probes, see the Probe Resource Center at: [www.keysight.com/find/PRC](http://www.keysight.com/find/PRC)

## Software and Firmware Updates

From time to time Keysight Technologies releases software and firmware updates for its products. To search for firmware updates for your oscilloscope, direct your web browser to [www.keysight.com/find/1200X-Series-sw](http://www.keysight.com/find/1200X-Series-sw).

To view the currently installed software and firmware press **[Help] > About Oscilloscope**.

Once you have downloaded a firmware update file, you can place it on a USB storage device and load the file using File Explorer (see [Chapter 22](#), "Utility Settings," starting on page 233).

## Binary Data (.bin) Format

The binary data format stores waveform data in binary format and provides data headers that describe that data.

Because the data is in binary format, the size of the file is approximately 5 times smaller than the ASCII XY format.

If more than one source is on, all displayed sources will be saved, except math functions.

When using segmented memory, each segment is treated as a separate waveform. All segments for a channel are saved, then all segments of the next (higher numbered) channel are saved. This continues until all displayed channels are saved.

When the oscilloscope is in the Peak Detect acquisition mode, the minimum and maximum value waveform data points are saved to the file in separate waveform buffers. The minimum value data points are saved first; then, the maximum value data points are saved.

#### **BIN data - using segmented memory**

When saving all segments, each segment has its own waveform header (see "**Binary Header Format**" on page 267).

In BIN file format, data are presented as follows:

- Channel 1 data (all segments)
- Channel 2 data (all segments)
- Channel 3 data (all segments)
- Channel 4 data (all segments)
- Digital channel data (all segments)
- Math waveform data (all segments)

When not saving all segments, the number of waveforms is equivalent to the number of active channels (including math and digital channels, with up to seven waveforms for each digital pod). When saving all segments, the number of waveforms is equal to the number of active channels multiplied by the number of segments acquired.

## Binary Data in MATLAB

Binary data from an InfiniiVision oscilloscope can be imported to The MathWorks MATLAB. You can download the appropriate MATLAB functions from the Keysight Technologies web site at [www.keysight.com/find/1200X-Series-examples](http://www.keysight.com/find/1200X-Series-examples).

Keysight provides the .m files, which need to be copied into the work directory for MATLAB. The default work directory is C:\MATLAB7\work.

## Binary Header Format

**File Header** There is only one file header in a binary file. The file header consists of the following information.

Cookie	Two byte characters, AG, that indicate the file is in the Keysight Binary Data file format.
Version	Two bytes that represent the file version.
File Size	A 32-bit integer that is the number of bytes that are in the file.
Number of Waveforms	A 32-bit integer that is the number of waveforms that are stored in the file.

**Waveform Header**

It is possible to store more than one waveform in the file, and each waveform stored will have a waveform header. When using segmented memory, each segment is treated as a separate waveform. The waveform header contains information about the type of waveform data that is stored following the waveform data header.

Header Size	A 32-bit integer that is the number of bytes in the header.
Waveform Type	A 32-bit integer that is the type of waveform stored in the file: <ul style="list-style-type: none"> <li>▪ 0 = Unknown.</li> <li>▪ 1 = Normal.</li> <li>▪ 2 = Peak Detect.</li> <li>▪ 3 = Average.</li> <li>▪ 4 = Not used in InfiniiVision oscilloscopes.</li> <li>▪ 5 = Not used in InfiniiVision oscilloscopes.</li> <li>▪ 6 = Logic.</li> </ul>
Number of Waveform Buffers	A 32-bit integer that is the number of waveform buffers required to read the data.
Points	A 32-bit integer that is the number of waveform points in the data.
Count	A 32-bit integer that is the number of hits at each time bucket in the waveform record when the waveform was created using an acquisition mode like averaging. For example, when averaging, a count of four would mean every waveform data point in the waveform record has been averaged at least four times. The default value is 0.
X Display Range	A 32-bit float that is the X-axis duration of the waveform that is displayed. For time domain waveforms, it is the duration of time across the display. If the value is zero then no data has been acquired.

X Display Origin	A 64-bit double that is the X-axis value at the left edge of the display. For time domain waveforms, it is the time at the start of the display. This value is treated as a double precision 64-bit floating point number. If the value is zero then no data has been acquired.
X Increment	A 64-bit double that is the duration between data points on the X axis. For time domain waveforms, this is the time between points. If the value is zero then no data has been acquired.
X Origin	A 64-bit double that is the X-axis value of the first data point in the data record. For time domain waveforms, it is the time of the first point. This value is treated as a double precision 64-bit floating point number. If the value is zero then no data has been acquired.
X Units	A 32-bit integer that identifies the unit of measure for X values in the acquired data: <ul style="list-style-type: none"> <li>▪ 0 = Unknown.</li> <li>▪ 1 = Volts.</li> <li>▪ 2 = Seconds.</li> <li>▪ 3 = Constant.</li> <li>▪ 4 = Amps.</li> <li>▪ 5 = dB.</li> <li>▪ 6 = Hz.</li> </ul>
Y Units	A 32-bit integer that identifies the unit of measure for Y values in the acquired data. The possible values are listed above under X Units.
Date	A 16-byte character array, left blank in InfiniiVision oscilloscopes.
Time	A 16-byte character array, left blank in the InfiniiVision oscilloscopes.
Frame	A 24 byte character array that is the model number and serial number of the oscilloscope in the format of: MODEL#:SERIAL#.
Waveform Label	A 16 byte character array that contains the label assigned to the waveform.
Time Tags	A 64-bit double, only used when saving multiple segments (requires segmented memory option). This is the time (in seconds) since the first trigger.
Segment Index	A 32-bit unsigned integer. This is the segment number. Only used when saving multiple segments.

**Waveform Data Header** A waveform may have more than one data set. Each waveform data set will have a waveform data header. The waveform data header consists of information about the waveform data set. This header is stored immediately before the data set.

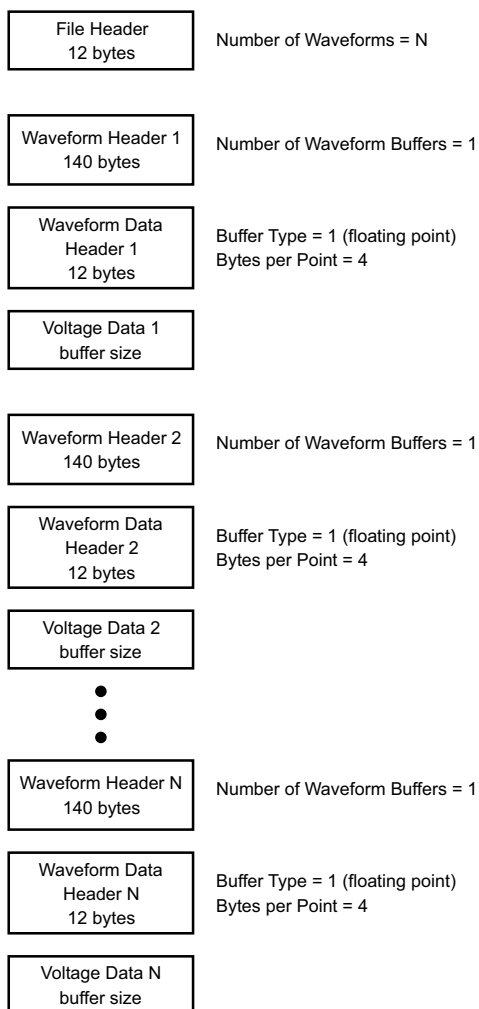
Waveform Data Header Size	A 32-bit integer that is the size of the waveform data header.
Buffer Type	A 16-bit short that is the type of waveform data stored in the file: <ul style="list-style-type: none"> <li>▪ 0 = Unknown data.</li> <li>▪ 1 = Normal 32-bit float data.</li> <li>▪ 2 = Maximum float data.</li> <li>▪ 3 = Minimum float data.</li> <li>▪ 4 = Not used in InfiniiVision oscilloscopes.</li> <li>▪ 5 = Not used in InfiniiVision oscilloscopes.</li> <li>▪ 6 = Digital unsigned 8-bit char data (for digital channels).</li> </ul>
Bytes Per Point	A 16-bit short that is the number of bytes per data point.
Buffer Size	A 32-bit integer that is the size of the buffer required to hold the data points.

## Example Program for Reading Binary Data

To find an example program for reading binary data, direct your web browser to [www.keysight.com/find/1200X-Series-examples](http://www.keysight.com/find/1200X-Series-examples), and select "Example Program for Reading Binary Data".

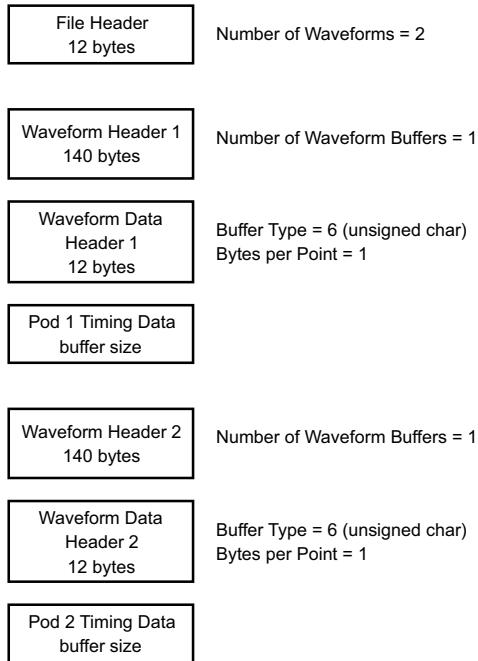
## Examples of Binary Files

**Single Acquisition Multiple Analog Channels** The following picture shows a binary file of a single acquisition with multiple analog channels.



### Single Acquisition All Pods Logic Channels

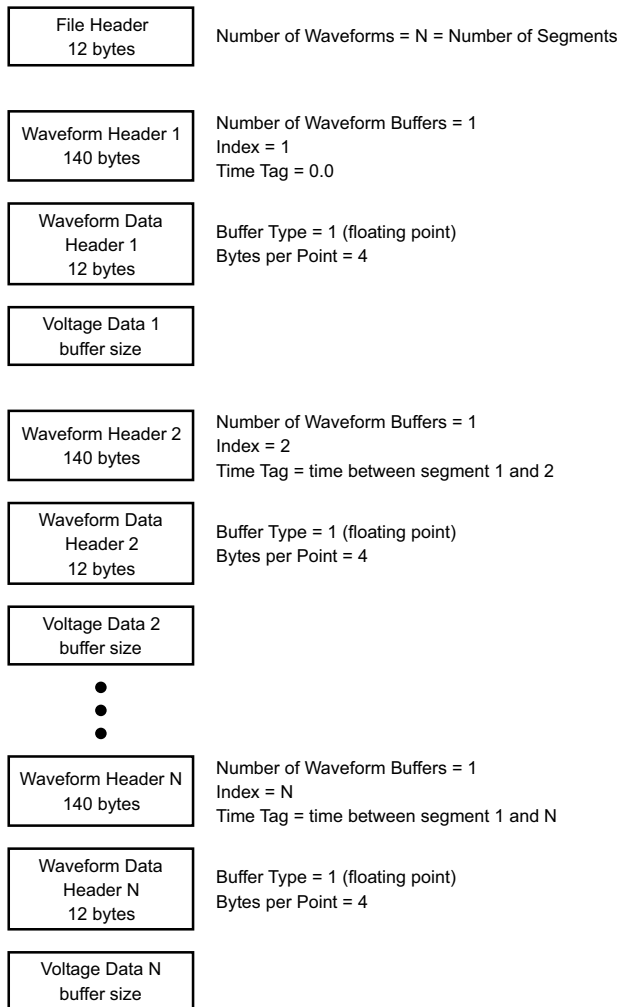
The following picture shows a binary file of a single acquisition with all pods for the logic channels saved.



**Segmented  
Memory  
Acquisition on One  
Analog Channel**

The following picture shows a binary file of a segmented memory acquisition on one analog channel.





## CSV and ASCII XY files

- ["CSV and ASCII XY file structure"](#) on page 274
- ["Minimum and Maximum Values in CSV Files"](#) on page 274

## CSV and ASCII XY file structure

In CSV or ASCII XY format the **Length** control selects the number of points per segment. All segments are contained in the CSV file or in each ASCII XY data file.

For example: If the Length control is set to 1000 points, there will be 1000 points (rows in the spreadsheet) per segment. When saving all segments there are three header rows, so the data for the first segment starts at row 4. The second segment's data starts at row 1004. The time column shows the time since the trigger on the first segment. The top row shows the selected number of points per segment.

BIN files are a more efficient data transfer format than CSV or ASCII XY. Use this file format for fastest data transfer.

## Minimum and Maximum Values in CSV Files

If you are running a Minimum or Maximum measurement, the minimum and maximum values shown in the measurement display may not appear in the CSV file.

**Explanation:** When the oscilloscope's sample rate is 2 GSa/s, a sample will be taken every 500 ps. If the horizontal scale is set to 10 us/div, there will be 100 us of data displayed (because there are ten divisions across the screen). To find the total number of samples the oscilloscope will take:

$$100 \text{ us} \times 2 \text{ GSa/s} = 200\text{K samples}$$

The oscilloscope is required to display those 200K samples using 640 pixel columns. The oscilloscope will decimate the 200K samples to 640 pixel columns, and this decimation keeps track of the min and max values of all the points that are represented by any given column. Those min and max values will be displayed in that screen column.

A similar process is used to reduce the acquired data to produce a record usable for various analysis needs such as measurements and CSV data. This analysis record (or *measurement record*) is much larger than 640 and may in fact contain up to 65536 points. Still, once the # of acquired points > 65536, some form of decimation is required. The decimator used to produce a CSV record is configured to provide a best-estimate of all the samples that each point in the record represents. Therefore, the min and max values may not appear in the CSV file.

## Acknowledgements







Third party software acknowledgements and licenses for the InfiniiVision 1200 X-Series and EDUX1052A/G oscilloscopes with the embedded Linux operating system are located at



[www.keysight.com/find/1200X-Series-third-party-software](http://www.keysight.com/find/1200X-Series-third-party-software).

You can also find a link to this list on the Keysight InfiniiVision oscilloscopes manuals website at [www.keysight.com/find/1200X-Series-manual](http://www.keysight.com/find/1200X-Series-manual).

## Product Markings and Regulatory Information

These symbols are used on the 1200 X-Series oscilloscopes.

Symbol	Description
	Caution, risk of electric shock
	Caution, refer to accompanying documentation
	This symbol indicates separate collection for electrical and electronic equipment mandated under EU law as of August 13, 2005. All electric and electronic equipment are required to be separated from normal waste for disposal (Reference WEEE Directive 2002/96/EC).
	Indicates the time period during which no hazardous or toxic substance elements are expected to leak or deteriorate during normal use. Forty years is the expected useful life of the product.
	The RCM mark is a registered trademark of the Australian Communications and Media Authority.
	The CE mark is a registered trademark of the European Community. ICES / NMB-001 Cet appareil ISM est conforme a la norme NMB du Canada. This is a marking to indicate product compliance with the Industry Canadian Interference-Causing Equipment Standard (ICES-001). This is also a symbol of an Industrial Scientific and Medical Group 1 Class A product (CISPR 11, Clause 4).

Symbol	Description
	<p>The CSA mark is a registered trademark of the CSA International.</p>
	<p>South Korean Certification (KC) mark; includes the marking's identifier code which follows this format: MSIP-REM-YYY-<u>ZZZZZZZZZZZZZZZZ</u>.</p>

# 25 CAN Triggering and Serial Decode

Setup for CAN Signals / 277

CAN Triggering / 279

CAN Serial Decode / 281

CAN triggering and serial decode is available on DSOX1200-Series oscilloscopes.

## Setup for CAN Signals

Setup consists of connecting the oscilloscope to a CAN signal, using the CAN Signals menu to specify the signal source, threshold voltage level, baud rate, and sample point.

To set up the oscilloscope to capture CAN signals, use the **Signals** softkey which appears in the Analyze menu:

- 1 Press **[Display]** > **Labels** > **Display** to turn on labels.
- 2 Press the **[Analyze]** key.
- 3 Press **Features**; then, select **Serial Bus**.
- 4 Press **Features** again (or push the Entry knob) to enable the serial bus display.
- 5 Press the **Mode** softkey; then, select **CAN**.

6 Press the **Signals** softkey to open the CAN Signals menu.

7 Press **Source**; then, select the channel for the CAN signal.

The label for the CAN source channel is automatically set.

8 Press the **Threshold** softkey; then, turn the Entry knob to select the CAN signal threshold voltage level.

The threshold voltage level is used in decoding, and it will become the trigger level when the trigger type is set to the selected serial decode slot.

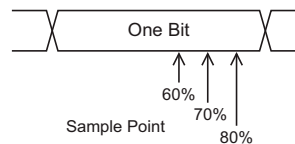
9 Press the **Baud** softkey; then, turn the Entry knob to select the baud rate that matches your CAN bus signal.

The CAN baud rate can be set to predefined baud rates from 10 kb/s up to 5 Mb/s or a user-defined baud rate from 10.0 kb/s to 4 Mb/s in increments of 100 b/s. Fractional user-defined baud rates between 4 Mb/s and 5 Mb/s are not allowed.

The default baud rate is 125 kb/s

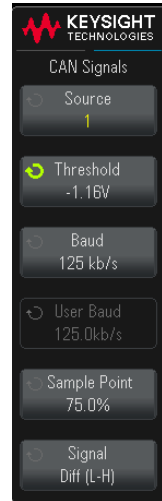
If none of the pre-defined selections match your CAN bus signal, select **User Defined**; then, press the **User Baud** softkey and turn the Entry knob to enter the baud rate.

10 Press the **Sample Point** softkey; then, turn the Entry knob to select the point between phase segments 1 and 2 where the state of the bus is measured. This controls the point within the bit's time where the bit value is captured.



11 Press the **Signal** softkey and select the type and polarity of the CAN signal. This also automatically sets the channel label for the source channel.

- **CAN\_H** – The actual CAN\_H differential bus.



- **Differential (H-L)** – The CAN differential bus signals connected to an analog source channel using a differential probe. Connect the probe's positive lead to the dominant-high CAN signal (CAN\_H) and connect the negative lead to the dominant-low CAN signal (CAN\_L).

Dominant low signals:

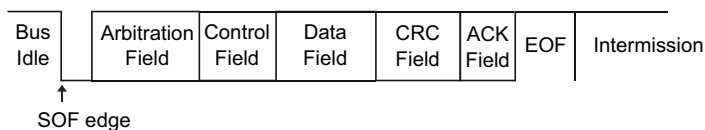
- **Rx** – The Receive signal from the CAN bus transceiver.
- **Tx** – The Transmit signal from the CAN bus transceiver.
- **CAN\_L** – The actual CAN\_L differential bus signal.
- **Differential (L-H)** – The CAN differential bus signals connected to an analog source channel using a differential probe. Connect the probe's positive lead to the dominant-low CAN signal (CAN\_L) and connect the negative lead to the dominant-high CAN signal (CAN\_H).

## CAN Triggering

To set up the oscilloscope to capture a CAN signal, see "[Setup for CAN Signals](#)" on page 277.

The Controller Area Network (CAN) trigger allows triggering on CAN version 2.0A and 2.0B signals.

A CAN message frame in CAN\_L signal type is shown below:



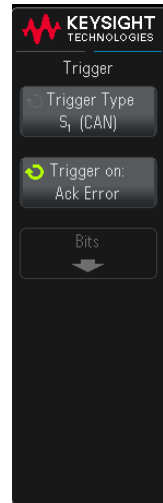
After setting up the oscilloscope to capture a CAN signal:

- 1 Press **[Trigger]**.
- 2 In the Trigger menu, press the **Trigger Type** softkey.

- 3 Press the **Trigger Type** softkey; then, turn the Entry knob to select the serial slot (Serial 1) on which the CAN signal is being decoded.
  
- 4 Press the **Trigger on:** softkey; then, turn the Entry knob to select the trigger condition:
  - **SOF - Start of Frame** – The oscilloscope triggers at the start of a frame.
  - **Remote Frame ID (RTR)** – The oscilloscope triggers on remote frames with the specified ID. Press the **Bits** softkey to select the ID.
  - **Data Frame ID (~RTR)** – The oscilloscope will trigger on data frames matching the specified ID. Press the **Bits** softkey to select the ID.
  - **Remote or Data Frame ID** – The oscilloscope will trigger on remote or data frames matching the specified ID. Press the **Bits** softkey to select the ID.
  - **Data Frame ID and Data** – The oscilloscope will trigger on data frames matching the specified ID and data. Press the **Bits** softkey to select the ID and set up the number of data bytes and values.
  - **Error Frame** – The oscilloscope will trigger on CAN active error frames.
  - **All Errors** – The oscilloscope will trigger when any form error or active error is encountered.
  - **Acknowledge Error** – The oscilloscope will trigger when the acknowledge bit is recessive (high).
  - **Overload Frame** – The oscilloscope will trigger on CAN overload frames.
  
- 5 If you select a condition that lets you trigger on ID or data values, use the **Bits** softkey and the CAN Bits menu to specify those values.

For details about using the CAN Bits menu softkeys, press and hold the softkey in question to display the built-in help.

You can use the **Zoom** mode for easier navigation of the decoded data.



## NOTE

If the setup does not produce a stable trigger, the CAN signal may be slow enough that the oscilloscope is auto-triggering. Press the **[Trigger]** key, then press the **Mode** softkey to set the trigger mode from **Auto** to **Normal**.



To display CAN serial decode, see "[CAN Serial Decode](#)" on page 281.

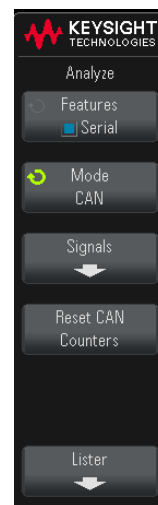
## CAN Serial Decode

To set up the oscilloscope to capture CAN signals, see "[Setup for CAN Signals](#)" on page 277.

For CAN triggering set up see "[CAN Triggering](#)" on page 279.

To set up CAN serial decode:

- 1 Press the **[Analyze]** key.
- 2 Press **Features**; then, select **Serial Bus**.
- 3 Press **Features** again (or push the Entry knob) to enable the serial bus display.
- 4 Press the **Mode** softkey; then, select **CAN**.
- 5 If the oscilloscope is stopped, press the **[Run/Stop]** key to acquire and decode data.



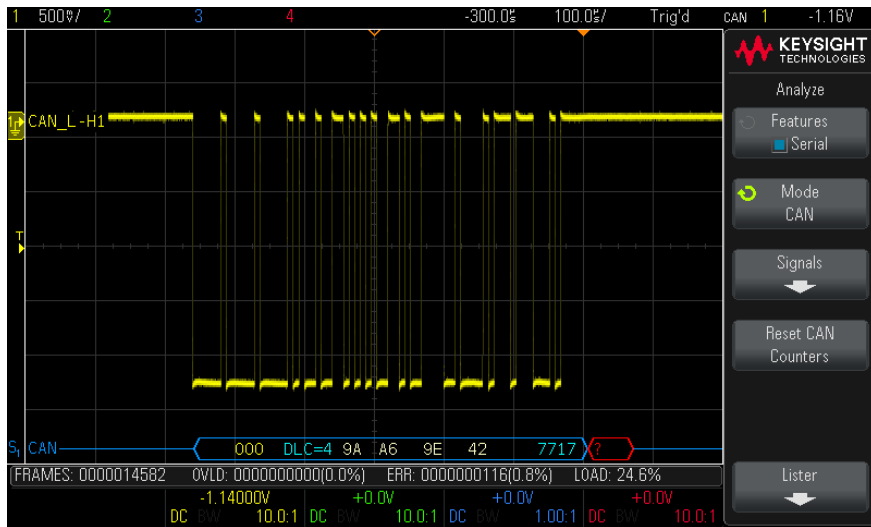
### NOTE

If the setup does not produce a stable trigger, the CAN signal may be slow enough that the oscilloscope is auto-triggering. Press the **[Trigger]** key, then press the **Mode** softkey to set the trigger mode from **Auto** to **Normal**.

You can use the horizontal **Zoom** window for easier navigation of the decoded data.

- See Also
- ["Interpreting CAN Decode"](#) on page 282
  - ["CAN Totalizer"](#) on page 283
  - ["Interpreting CAN Lister Data"](#) on page 284

## Interpreting CAN Decode

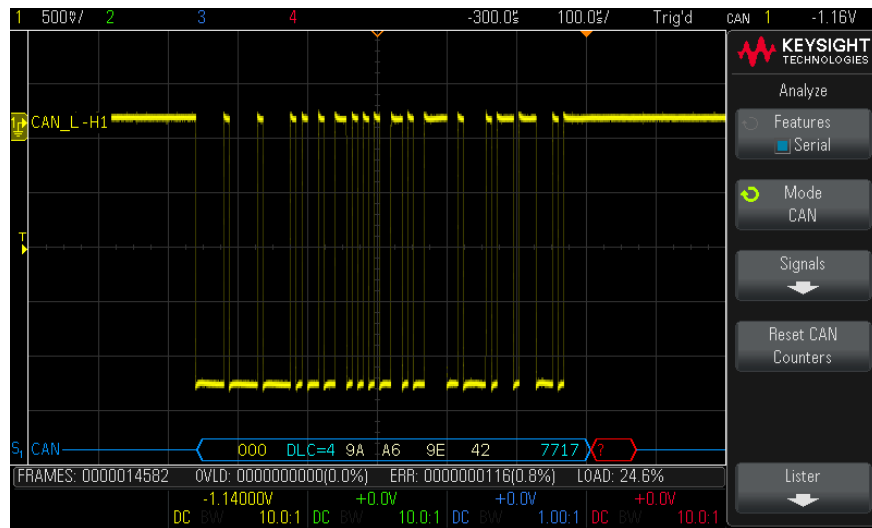


- Frame ID appears in hex digits in yellow. Frames of 11 or 29 bits are automatically detected.
- Remote frame (RMT) appears in green.
- Data length code (DLC) appears in blue for data frames and green for remote frames.
- Data bytes appear in hex digits in white for data frames.
- Cyclic redundancy check (CRC) appears in hex digits in blue when valid, or in red to indicate that the oscilloscope's hardware decode calculated a CRC that is different from the incoming CRC data stream.
- Angled waveforms show an active bus (inside a packet/frame).
- Mid-level blue lines show an idle bus.
- Decoded text is truncated at the end of the associated frame when there is insufficient space within frame boundaries.

- Pink vertical bars indicate you need to expand the horizontal scale (and run again) to see decode.
- Red dots in the decode line indicate that there is data that is not being displayed. Scroll or expand the horizontal scale to view the information.
- Aliased bus values (undersampled or indeterminate) are drawn in pink.
- Unknown bus values (undefined or error conditions) are drawn in red with a "?" label.
- Flagged error frames are drawn in red with an "ERR" label.

## CAN Totalizer

The CAN totalizer provides a direct measure of bus quality and efficiency. The CAN totalizer measures total CAN frames, flagged error frames, overload frames, and bus utilization.

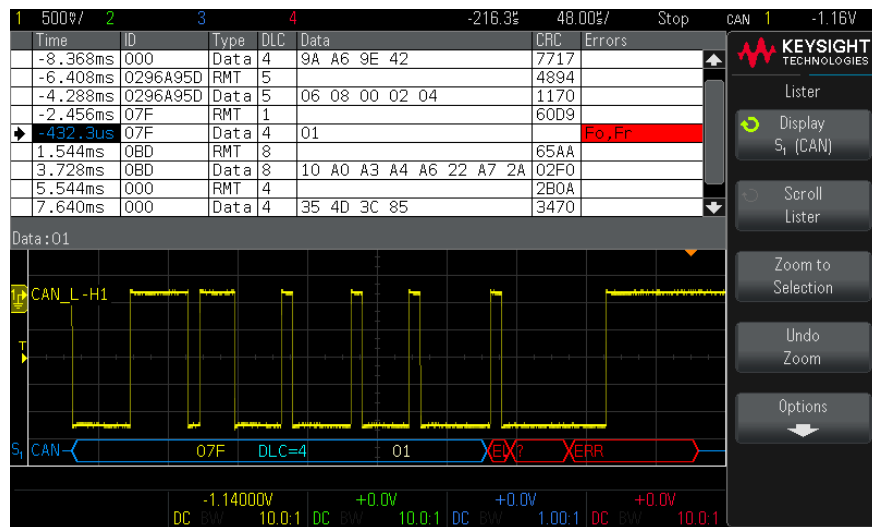


The totalizer is always running (counting frames and calculating percentages) and is displayed whenever CAN decode is displayed. The totalizer counts even when the oscilloscope is stopped (not acquiring data). Pressing the **[Run/Stop]** key does not affect the totalizer. When an overflow condition occurs, the counter displays **OVERFLOW**. The counters can be reset to zero by pressing the **Reset CAN Counters** softkey.

- Types of Frames**
- Active error frames are CAN frames in which a CAN node recognizes an error condition during a data or remote frame and issues an active error flag.
  - A partial frame occurs when the oscilloscope detects any error condition during a frame that is not followed by an active error flag. Partial frames are not counted.
- Counters**
- The FRAMES counter gives the total number of completed remote, data, overload, and active error frames.
  - The OVLD counter gives the total number of completed overload frames and their percentage of the total number of frames.
  - The ERR counter gives the total number of completed active error frames and their percentage of the total number of frames.
  - The LOAD (bus load) indicator measures the percentage of time the bus is active. The calculation is done on 330 ms periods, approximately every 400 ms.

Example: If a data frame contains an active error flag, both the FRAMES counter and the ERR counter will be incremented. If a data frame contains an error that is not an active error it is considered a partial frame and no counters are incremented.

### Interpreting CAN Lister Data



In addition to the standard Time column, the CAN Lister contains these columns:

- ID – frame ID.
- Type – frame type (RMT remote frame or Data).
- DLC – data length code.
- Data – data bytes.
- CRC – cyclic redundancy check.
- Errors – highlighted in red. Errors can be Acknowledge (Ack, A), Form (Fo), or Frame (Fr). Different kinds of errors can be combined like "Fo,Fr" in the above example.

Aliased data is highlighted in pink. When this happens, decrease the horizontal time/div setting and run again.



# 26 I2C Triggering and Serial Decode

Setup for I2C Signals / 287

I2C Triggering / 288

I2C Serial Decode / 292

I2C triggering and serial decode is available on DSOX1200-Series and EDUX1052A/G oscilloscopes.

## Setup for I2C Signals

I<sup>2</sup>C (Inter-IC bus) signals setup consists of connecting the oscilloscope to the serial data (SDA) line and the serial clock (SCL) line and then specifying the input signal threshold voltage levels.

To set up the oscilloscope to capture I<sup>2</sup>C signals, use the **Signals** softkey which appears in the Analyze menu:

- 1 Press **[Display]** > **Labels** > **Display** to turn on labels.
- 2 Press the **[Analyze]** key.
- 3 Press **Features**; then, select **Serial Bus**.
- 4 Press **Features** again (or push the Entry knob) to enable the serial bus display.
- 5 Press the **Mode** softkey; then, select **I2C**.

- 6 Press the **Signals** softkey to open the I<sup>2</sup>C Signals menu.
- 7 For both the SCL (serial clock) and SDA (serial data) signals:
  - a Connect an oscilloscope channel to the signal in the device under test.
  - b Press the **SCL** or **SDA** softkey; then, turn the Entry knob to select the channel for the signal.
  - c Press the corresponding **Threshold** softkey; then, turn the Entry knob to select the signal threshold voltage level.

The threshold voltage level is used in decoding, and it will become the trigger level when the trigger type is set to the selected serial decode slot.

Data must be stable during the whole high clock cycle or it will be interpreted as a start or stop condition (data transitioning while the clock is high).

The SCL and SDA labels for the source channels are automatically set.



## I2C Triggering

To set up the oscilloscope to capture I2C signals, see "[Setup for I2C Signals](#)" on page 287.

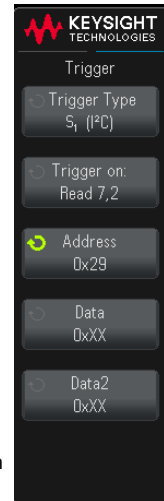
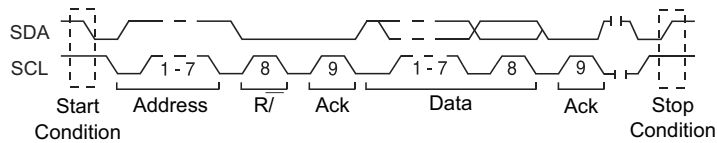
After the oscilloscope has been set up to capture I2C signals, you can trigger on a stop/start condition, a restart, a missing acknowledge, an EEPROM data read, or on a read/write frame with a specific device address and data value.

- 1 Press **[Trigger]**.
- 2 In the Trigger menu, press the **Trigger Type** softkey.

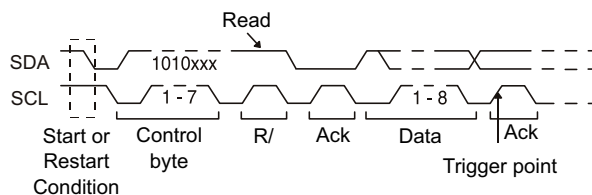


- 3 Press the **Trigger Type** softkey; then, turn the Entry knob to select the serial slot (Serial 1) on which the I<sup>2</sup>C signals are being decoded.
- 4 Press the **Trigger:** softkey; then, turn the Entry knob to select the trigger condition:

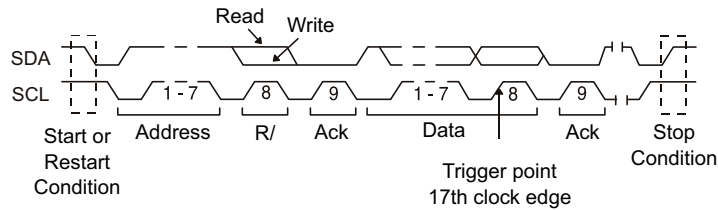
- **Start Condition**— The oscilloscope triggers when SDA data transitions from high to low while the SCL clock is high. For triggering purposes (including frame triggers), a restart is treated as a start condition.
- **Stop Condition**— The oscilloscope triggers when data (SDA) transitions from low to high while the clock (SCL) is high.



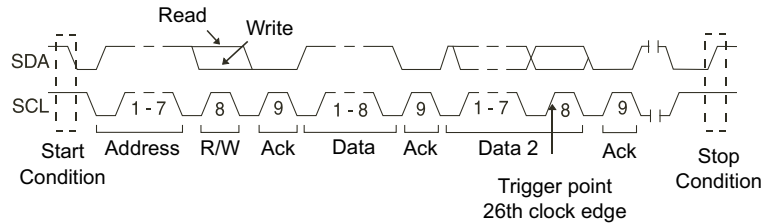
- **Missing Acknowledge**— The oscilloscope triggers when SDA data is high during any Ack SCL clock bit.
- **Address with no Ack**— The oscilloscope triggers when the acknowledge of the selected address field is false. The R/W bit is ignored.
- **Restart**— The oscilloscope triggers when another start condition occurs before a stop condition.
- **EEPROM Data Read**— The trigger looks for EEPROM control byte value 1010xxx on the SDA line, followed by a Read bit and an Ack bit. It then looks for the data value and qualifier set by the **Data** softkey and the **Data is** softkey. When this event occurs, the oscilloscope will trigger on the clock edge for the Ack bit after the data byte. This data byte does not need to occur directly after the control byte.



- **Frame (Start: Addr7: Read: Ack: Data) or Frame (Start: Addr7: Write: Ack: Data)**— The oscilloscope triggers on a read or write frame in 7-bit addressing mode on the 17th clock edge if all bits in the pattern match. For triggering purposes, a restart is treated as a start condition.



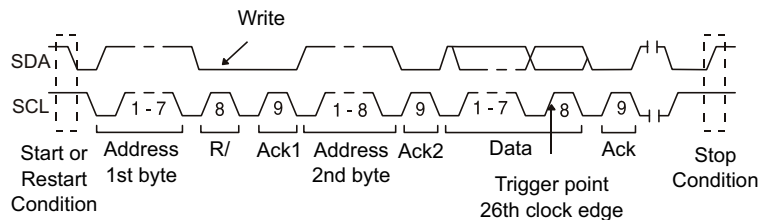
- **Frame (Start: Addr7: Read: Ack: Data: Ack: Data2) or Frame (Start: Addr7: Write: Ack: Data: Ack: Data2)**— The oscilloscope triggers on a read or write frame in 7-bit addressing mode on the 26th clock edge if all bits in the pattern match. For triggering purposes, a restart is treated as a start condition.



- **10-bit Write** – The oscilloscope triggers on a 10-bit write frame on the 26th clock edge if all bits in the pattern match. The frame is in the format:

Frame (Start: Address byte 1: Write: Address byte 2: Ack: Data)

For triggering purposes, a restart is treated as a start condition.



**5** If you have set the oscilloscope to trigger on an EEPROM Data Read condition:

Press the **Data is** softkey to set the oscilloscope to trigger when data is = (equal to),  $\neq$  (not equal to),  $<$  (less than), or  $>$  (greater than) the data value set in the **Data** softkey.

The oscilloscope will trigger on the clock edge for the Ack bit after the trigger event is found. This data byte does not need to occur directly after the control byte. The oscilloscope will trigger on any data byte that meets the criteria defined by the **Data is** and **Data** softkeys during a current address read or a random read or a sequential read cycle.

**6** If you have set the oscilloscope to trigger on a 7-bit address read or write frame condition or a 10-bit write frame condition:

- a** Press the **Address** softkey and turn the Entry knob to select the 7-bit or 10-bit device address.

You can select from an address range of 0x00 to 0x7F (7-bit) or 0x3FF (10-bit) hexadecimal. When triggering on a read/write frame, the oscilloscope will trigger after the start, address, read/write, acknowledge, and data events occur.

If don't care is selected (0xXX or 0xFFFF) for the address, the address will be ignored. The trigger will always occur on the 17th clock for 7-bit addressing or 26th clock for 10-bit addressing.

- b** Press the **Data** value softkey and turn the Entry knob to select the 8-bit data pattern on which to trigger.

You can select a data value in the range of 0x00 to 0xFF (hexadecimal). The oscilloscope will trigger after the start, address, read/write, acknowledge, and data events occur.

If don't care (0xFF) is selected for data, the data will be ignored. The trigger will always occur on the 17th clock for 7-bit addressing or 26th clock for 10-bit addressing.

- c** If you have selected a three-byte trigger, press the **Data2** value softkey and turn the Entry knob to select the 8-bit data pattern on which to trigger.

To display I2C serial decode, see "**I2C Serial Decode**" on page 292.

## I2C Serial Decode

To set up the oscilloscope to capture I2C signals, see "[Setup for I2C Signals](#)" on page 287.

For I2C triggering setup see "[I2C Triggering](#)" on page 288.

To set up I2C serial decode:

- 1 Press the **[Analyze]** key.
- 2 Press **Features**; then, select **Serial Bus**.
- 3 Press **Features** again (or push the Entry knob) to enable the serial bus display.
- 4 Press the **Mode** softkey; then, select **I2C**.
- 5 Choose 7-bit or 8-bit address size. Use 8-bit address size to include the R/W bit as part of the address value, or choose 7-bit address size to exclude the R/W bit from the address value.
- 6 If the oscilloscope is stopped, press the **[Run/Stop]** key to acquire and decode data.



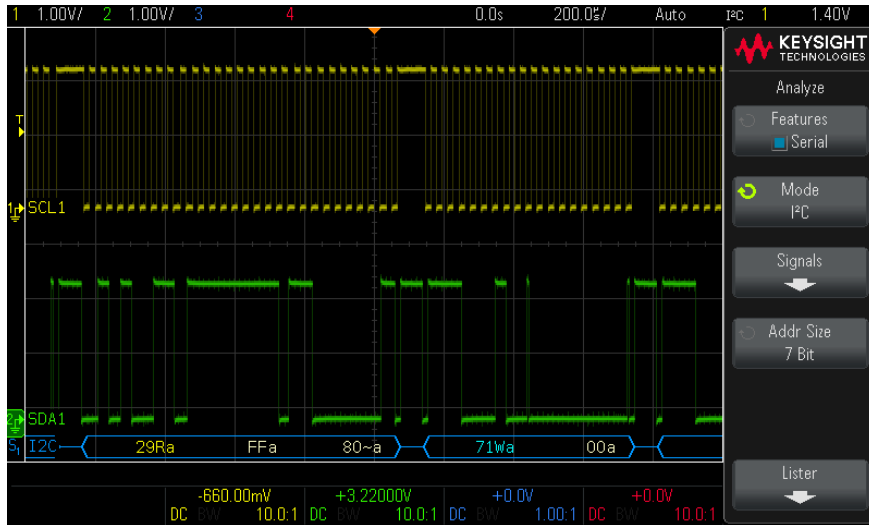
### NOTE

If the setup does not produce a stable trigger, the I2C signals may be slow enough that the oscilloscope is auto-triggering. Press the **[Trigger]** key, then press the **Mode** softkey to set the trigger mode from **Auto** to **Normal**.

You can use the horizontal **Zoom** window for easier navigation of the acquired data.

- See Also
- "[Interpreting I2C Decode](#)" on page 293
  - "[Interpreting I2C Lister Data](#)" on page 294

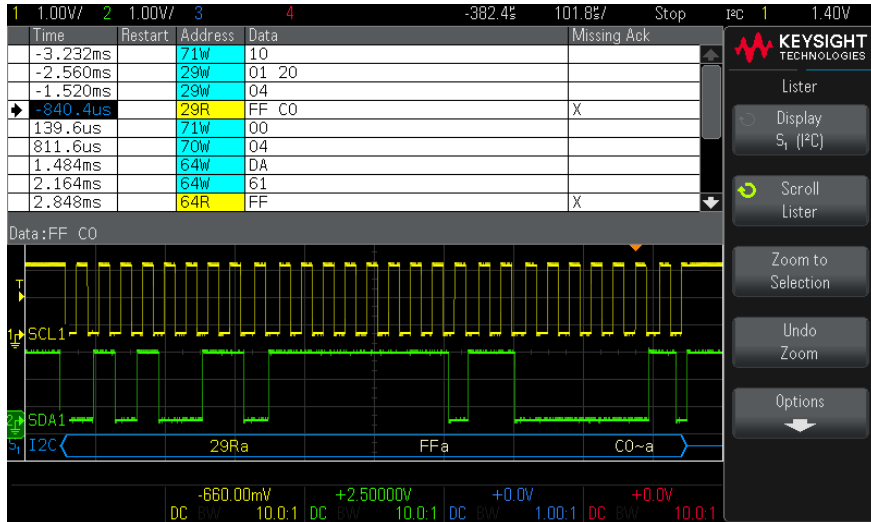
## Interpreting I2C Decode



- Angled waveforms show an active bus (inside a packet/frame).
- Mid-level blue lines show an idle bus.
- In the decoded hexadecimal data:
  - Address values appear at the start of a frame.
  - Write addresses appear in light-blue along with the "W" character.
  - Read addresses appear in yellow along with the "R" character.
  - Restart addresses appear in green along with the "S" character.
  - Data values appear in white.
  - "A" indicates Ack (low), "~A" indicates No Ack (high).
  - Decoded text is truncated at the end of the associated frame when there is insufficient space within frame boundaries.
- Pink vertical bars indicate you need to expand the horizontal scale (and run again) to see decode.
- Red dots in the decode line indicate that more data can be displayed. Scroll or expand the horizontal scale to view the data.
- Aliased bus values (undersampled or indeterminate) are drawn in pink.

- Unknown bus values (undefined or error conditions) are drawn in red.

## Interpreting I2C Lister Data



In addition to the standard Time column, the I2C Lister contains these columns:

- Restart – indicated with an "X".
- Address – colored blue for writes, yellow for reads.
- Data – data bytes.
- Missing Ack – indicated by an "X", highlighted in red if an error.

Aliased data is highlighted in pink. When this happens, decrease the horizontal time/div setting and run again.

# 27 LIN Triggering and Serial Decode

Setup for LIN Signals / 295

LIN Triggering / 297

LIN Serial Decode / 299

LIN triggering and serial decode is available on DSOX1200-Series oscilloscopes.

## Setup for LIN Signals

LIN (Local Interconnect Network) signal setup consists of connecting the oscilloscope to a serial LIN signal, specifying the signal source, threshold voltage level, baud rate, sample point, and other LIN signal parameters.

To set up the oscilloscope to capture LIN signals:

- 1 Press **[Display]** > **Labels** > **Display** to turn on labels.
- 2 Press the **[Analyze]** key.
- 3 Press **Features**; then, select **Serial Bus**.
- 4 Press **Features** again (or push the Entry knob) to enable the serial bus display.
- 5 Press the **Mode** softkey; then, select **LIN**.

6 Press the **Signals** softkey to open the LIN Signals menu.

7 Press the **Source** softkey to select the channel connected to the LIN signal line.

The label for the LIN source channel is automatically set.

8 Press the **Threshold** softkey; then, turn the Entry knob to set the LIN signal threshold voltage level to the middle of the LIN signal.

The threshold voltage level is used in decoding, and it will become the trigger level when the trigger type is set to the selected serial decode slot.


9 Press the **Baud Rate** softkey to open the LIN Baud Rate menu.

10 Press the **Baud** softkey; then, turn the Entry knob to select the baud rate that matches your LIN bus signal.

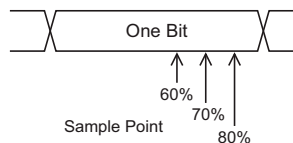
The default baud rate is 19.2 kb/s.

If none of the pre-defined selections match your LIN bus signal, select **User Defined**; then, press the **User Baud** softkey and turn the Entry knob to enter the baud rate.

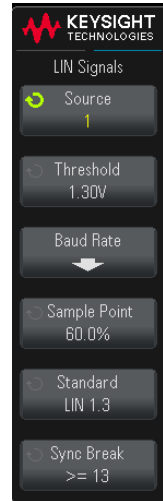
You can set the LIN baud rate from 2.4 kb/s to 625 kb/s in increments of 100 b/s.

11 Press the  Back key to return to the LIN Signals menu.

12 Press the **Sample Point** softkey; then, turn the Entry knob to select the sample point at which the oscilloscope will sample the bit value.



13 Press the **Standard** softkey; then, turn the Entry knob to select the LIN standard you are measuring (LIN 1.3 or LIN 2.0).





For LIN 1.2 signals, use the LIN 1.3 setting. The LIN 1.3 setting assumes the signal follows the "Table of Valid ID Values" as shown in section A.2 of the LIN Specification dated December 12, 2002. If your signal does not comply with the table, use the LIN 2.0 setting.

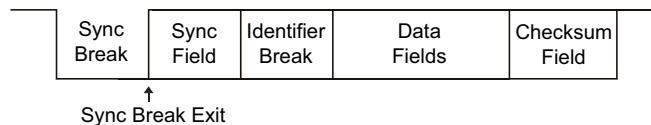
- 14 Press the **Sync Break** softkey and select the minimum number of clocks that define a sync break in your LIN signal.

## LIN Triggering

To set up the oscilloscope to capture a LIN signal, see "**Setup for LIN Signals**" on page 295.

LIN triggering can trigger on the rising edge at the Sync Break exit of the LIN single-wire bus signal (that marks the beginning of the message frame), the Frame ID, or the Frame ID and Data.

A LIN signal message frame is shown below:



- 1 Press **[Trigger]**.
- 2 In the Trigger menu, press the **Trigger Type** softkey.

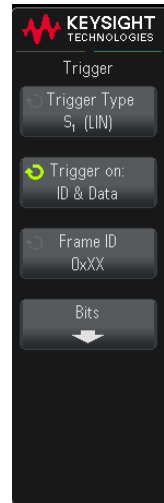
3 Press the **Trigger Type** softkey; then, turn the Entry knob to select the serial slot (Serial 1) on which the LIN signal is being decoded.

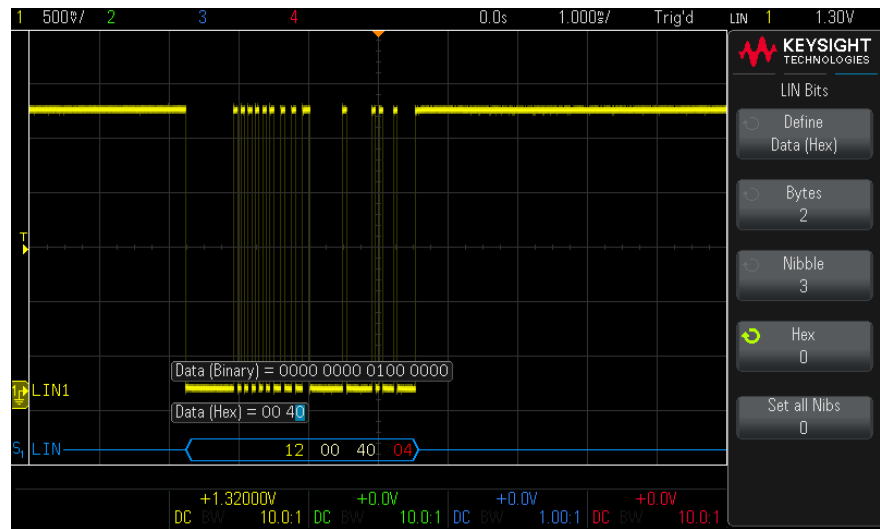
4 Press the **Trigger on:** softkey; then, turn the Entry knob to select the trigger condition:

- **Sync** (Sync Break) – The oscilloscope triggers on the rising edge at the Sync Break exit of the LIN single-wire bus signal that marks the beginning the message frame.
- **ID** (Frame ID) – The oscilloscope triggers when a frame with an ID equal to the selected value is detected. Use the **Entry** knob to select the value for the Frame ID.
- **ID & Data** (Frame ID and Data) – The oscilloscope triggers when a frame with an ID and data equal to the selected values is detected. When triggering on a frame ID and data:
  - To select the frame ID value, press the **Frame ID** softkey, and use the **Entry** knob.

Note that you can enter a "don't care" value for the frame ID and trigger on data values only.

- To set up the number of data bytes and enter their values (in hexadecimal or binary), press the **Bits** softkey to open the LIN Bits menu.



**NOTE**

For details about using the LIN Bits menu softkeys, press and hold the softkey in question to display the built-in help.

For LIN decode information see "[LIN Serial Decode](#)" on page 299.

## LIN Serial Decode

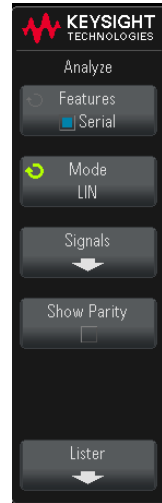
To set up the oscilloscope to capture LIN signals, see "[Setup for LIN Signals](#)" on page 295.

For LIN triggering setup see "[LIN Triggering](#)" on page 297.

To set up LIN serial decode:

- 1 Press the **[Analyze]** key.
- 2 Press **Features**; then, select **Serial Bus**.
- 3 Press **Features** again (or push the Entry knob) to enable the serial bus display.

- 4 Press the **Mode** softkey; then, select **LIN**.
- 5 Choose whether to include the parity bits in the identifier field.
  - a If you want to mask the upper two parity bits, ensure that the box under the **Show Parity** softkey is not selected.
  - b If you want to include the parity bits in the identifier field, ensure that the box under the **Show Parity** softkey is selected.
- 6 If the oscilloscope is stopped, press the **[Run/Stop]** key to acquire and decode data.

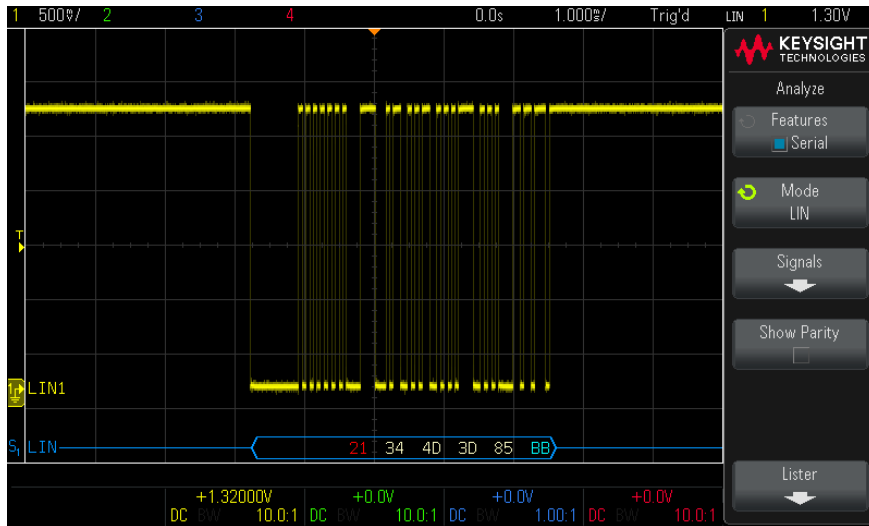
**NOTE**

If the setup does not produce a stable trigger, the LIN signal may be slow enough that the oscilloscope is auto-triggering. Press the **[Trigger]** key, then press the **Mode** softkey to set the trigger mode from **Auto** to **Normal**.

You can use the horizontal **Zoom** window for easier navigation of the decoded data.

- See Also
- ["Interpreting LIN Decode"](#) on page 301
  - ["Interpreting LIN Lister Data"](#) on page 302

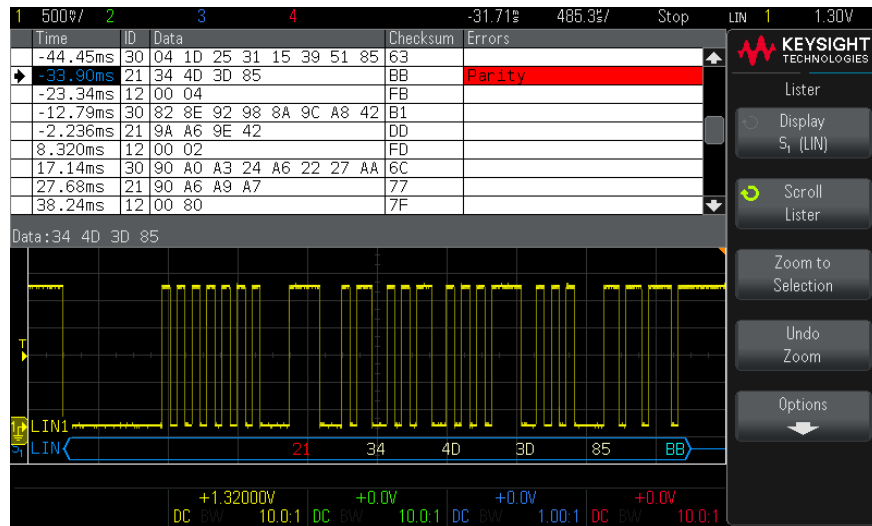
## Interpreting LIN Decode



- Angled waveforms show an active bus (inside a packet/frame).
- Mid-level blue lines show an idle bus (LIN 1.3 only).
- The hexadecimal ID and parity bits (if enabled) appear in yellow. If a parity error is detected the hexadecimal ID and parity bits (if enabled) appear in red.
- Decoded hexadecimal data values appear in white.
- For LIN 1.3, the checksum appears in blue if correct, or red if incorrect. The checksum always appears in white for LIN 2.0.
- Decoded text is truncated at the end of the associated frame when there is insufficient space within frame boundaries.
- Pink vertical bars indicate you need to expand the horizontal scale (and run again) to see decode.
- Red dots in the decode line indicate that there is data that is not being displayed. Scroll or expand the horizontal scale to view the information.
- Unknown bus values (undefined or error conditions) are drawn in red.
- If there is an error in the synch field, SYNC will appear in red.
- If the header exceeds the length specified in the standard, THM will appear red.

- If the total frame count exceeds the length specified in the standard, TFM will appear red (LIN 1.3 only).
- For LIN 1.3 a wakeup signal is indicated by WAKE in blue. If the wakeup signal is not followed by a valid wakeup delimiter a wakeup error is detected and displayed as WUP in red.

## Interpreting LIN Lister Data



In addition to the standard Time column, the LIN Lister contains these columns:

- ID – frame ID.
- Data – (LIN 1.3 only) data bytes.
- Checksum – (LIN 1.3 only).
- Data and Checksum – (LIN 2.0 only).
- Errors – highlighted in red.

Aliased data is highlighted in pink. When this happens, decrease the horizontal time/div setting and run again.

# 28 SPI Triggering and Serial Decode

Setup for SPI Signals / 303

SPI Triggering / 309

SPI Serial Decode / 311

SPI triggering and serial decode is available on DSOX1200-Series oscilloscopes. The 2-channel DSOX1200-Series oscilloscopes support 3-wire SPI (Clock, Data, and CS). The 4-channel DSOX1200-Series oscilloscopes support 4-wire SPI (Clock, MOSI, MISO, and CS).

## NOTE

Only one SPI serial bus can be decoded at a time.

---

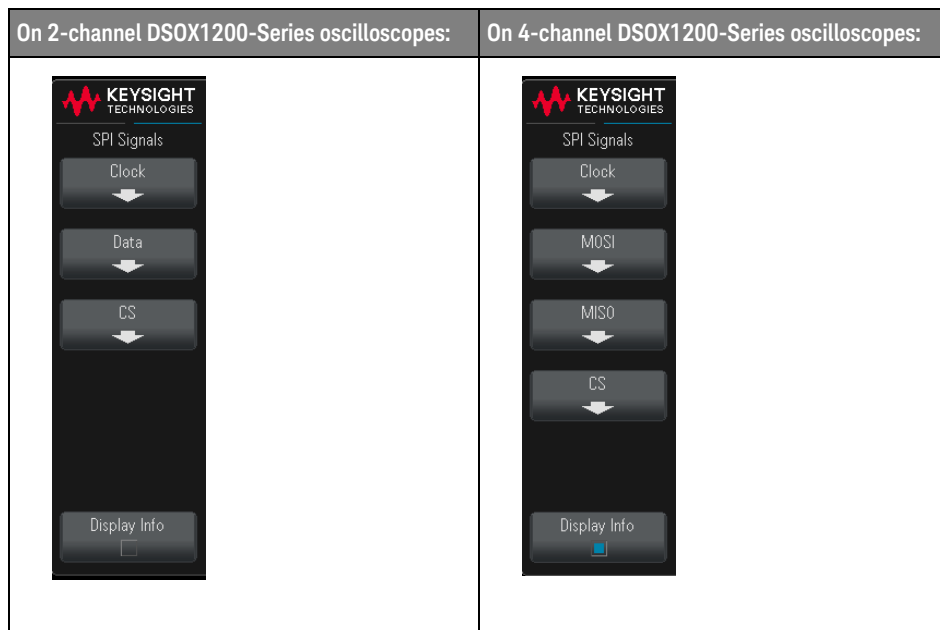
## Setup for SPI Signals

Serial Peripheral Interface (SPI) signals setup consists of connecting the oscilloscope to a clock, MOSI data, MISO data, and framing signal, then setting the threshold voltage level for each input channel, and finally specifying any other signal parameters.

To set up the oscilloscope to capture SPI signals, use the **Signals** softkey which appears in the Analyze menu:

- 1 Press **[Display]** > **Labels** > **Display** to turn on labels.
- 2 Press the **[Analyze]** key.

- 3 Press **Features**; then, select **Serial Bus**.
- 4 Press **Features** again (or push the Entry knob) to enable the serial bus display.
- 5 Press the **Mode** softkey; then, select **SPI**.
- 6 Press the **Signals** softkey to open the SPI Signals menu.





- 7 Press the **Clock** softkey to open the SPI Clock menu.

In the SPI Clock menu:

- a Press the **Clock** softkey; then, turn the Entry knob to select the channel connected to the SPI serial clock line.

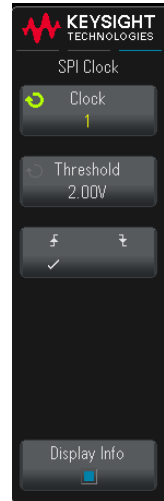
The CLK label for the source channel is automatically set.

- b Press the **Threshold** softkey; then, turn the Entry knob to select the clock signal threshold voltage level.

The threshold voltage level is used in decoding, and it will become the trigger level when the trigger type is set to the selected serial decode slot.

- c Press the slope softkey ( $\uparrow$   $\downarrow$ ) to select rising edge or falling edge for the selected Clock source.

This determines which clock edge the oscilloscope will use to latch the serial data. When **Display Info** is enabled, the graphic changes to show the current state of the clock signal.



- 8 On 2-channel DSOX1200-Series oscilloscopes (that support 3-wire SPI), press the **Data** softkey to open the SPI Data menu.

In the SPI Data menu:

- a Press the **Data** softkey; then, turn the Entry knob to select the channel that is connected to a SPI serial data line. (If the channel you selected is off, switch it on.)

The Data label for the source channel is automatically set.

- b Press the **Threshold** softkey; then, turn the Entry knob to select the data signal threshold voltage level.

The threshold voltage level is used in decoding, and it will become the trigger level when the trigger type is set to the selected serial decode slot.

- 9 On 4-channel DSOX1200-Series oscilloscopes (that support 4-wire SPI), press the **MOSI** softkey to open the SPI MOSI menu.

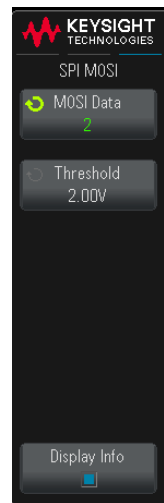
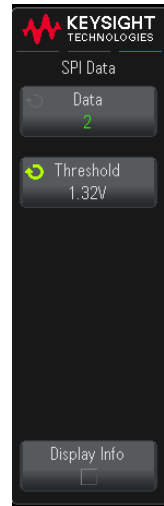
In the SPI MOSI menu:

- a Press the **MOSI Data** softkey; then, turn the Entry knob to select the channel that is connected to a SPI serial data line. (If the channel you selected is off, switch it on.)

The MOSI label for the source channel is automatically set.

- b Press the **Threshold** softkey; then, turn the Entry knob to select the MOSI signal threshold voltage level.

The threshold voltage level is used in decoding, and it will become the trigger level when the trigger type is set to the selected serial decode slot.



- 10 On 4-channel DSOX1200-Series oscilloscopes (that support 4-wire SPI), (optional) press the **MISO** softkey to open the SPI MISO menu.

In the SPI MISO menu:

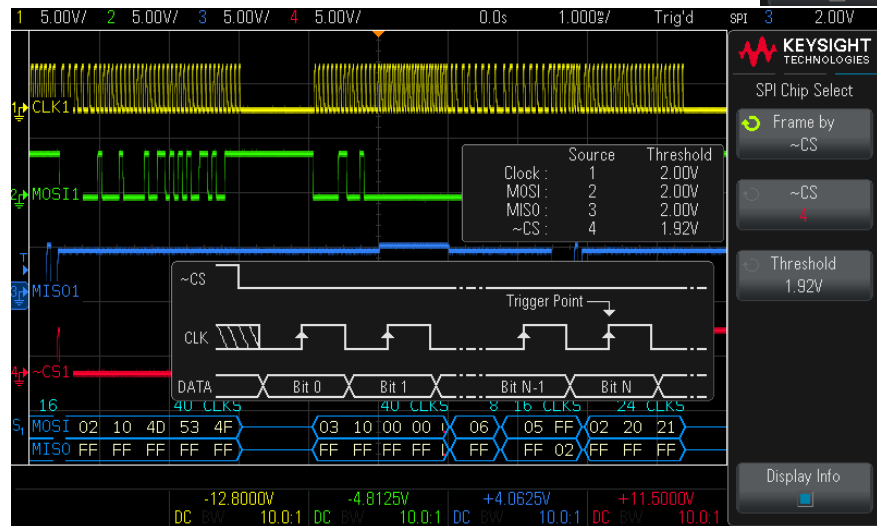
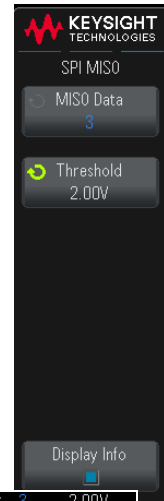
- a Press the **MISO Data** softkey; then, turn the Entry knob to select the channel that is connected to a second SPI serial data line. (If the channel you selected is off, switch it on.)

The MISO label for the source channel is automatically set.

- b Press the **Threshold** softkey; then, turn the Entry knob to select the MISO signal threshold voltage level.

The threshold voltage level is used in decoding, and it will become the trigger level when the trigger type is set to the selected serial decode slot.

- 11 Press the **CS** softkey to open the SPI Chip Select menu.



In the SPI Chip Select menu:

- a** Press the **Frame by** softkey to select a framing signal that the oscilloscope will use for determining which clock edge is the first clock edge in the serial stream.

You can set the oscilloscope to trigger during a high chip select (**CS**), a low chip select (**~CS**), or after a **Timeout** period during which the clock signal has been idle.

- If the framing signal is set to **CS** (or **~CS**), the first clock edge as defined, rising or falling, seen after the **CS** (or **~CS**) signal transitions from low to high (or high to low) is the first clock in the serial stream.

**Chip Select** – Press the **CS** or **~CS** softkey; then, turn the Entry knob to select the channel that is connected to the SPI frame line. The label (**~CS** or **CS**) for the source channel is automatically set. The data pattern and the clock transition must occur during the time when the framing signal is valid. The framing signal must be valid for the entire data pattern.

- If the framing signal is set to **Timeout**, the oscilloscope generates it's own internal framing signal after it sees inactivity on the serial clock line.

**Clock Timeout** – Select **Clock Timeout** in the **Frame by** softkey, then select the **Timeout** softkey and turn the Entry knob to set the minimum time that the Clock signal must be idle (not transitioning) before the oscilloscope will search for the Data pattern on which to trigger.

The Timeout value can be set anywhere from 100 ns to 10 s.

When you press the **Frame by** softkey, the **Display Info** graphic changes to show timeout selection or the current state of the chip select signal.

- b** Press the **Threshold** softkey; then, turn the Entry knob to select the chip select signal threshold voltage level.

The threshold voltage level is used in decoding, and it will become the trigger level when the trigger type is set to the selected serial decode slot.

When **Display Info** is enabled, information about the selected signal sources and their threshold voltage levels, as well as a waveform diagram, appears on the screen.

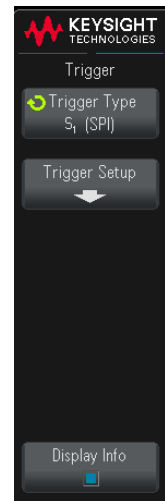
## SPI Triggering

To set up the oscilloscope to capture SPI signals, see "[Setup for SPI Signals](#)" on page 303.

After the oscilloscope has been set up to capture SPI signals, you can then trigger on a data pattern that occurs at the start of a frame. The serial data string can be specified to be from 4 to 32 bits long.

When you select the SPI trigger type and **Display Info** is enabled, a graphic is displayed showing the current state of the frame signal, clock slope, number of data bits, and data bit values.

- 1 Press **[Trigger]**.
- 2 In the Trigger menu, press the **Trigger Type** softkey.
- 3 Press the **Trigger Type** softkey; then, turn the Entry knob to select the serial slot (Serial 1) on which the SPI signals are being decoded.



4 Press the **Trigger Setup** softkey to open the SPI Trigger Setup menu.

5 Press the **Trigger Type** softkey; then, turn the Entry knob to select the trigger condition:

- **Master-Out, Slave-In (MOSI) Data** – for triggering on the MOSI data signal.
- **Master-In, Slave-Out (MISO) Data** – for triggering on the MISO data signal.

6 Press the **#Bits** softkey, and turn the Entry knob to set the number of bits (**#Bits**) in the serial data string.

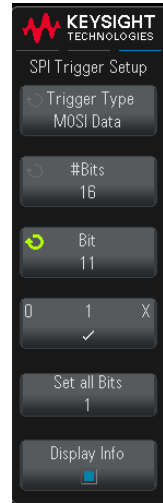
The number of bits in the string can be set anywhere from 4 bits to 64 bits. The data values for the serial string are displayed in the MOSI/MISO Data string in the waveform area.

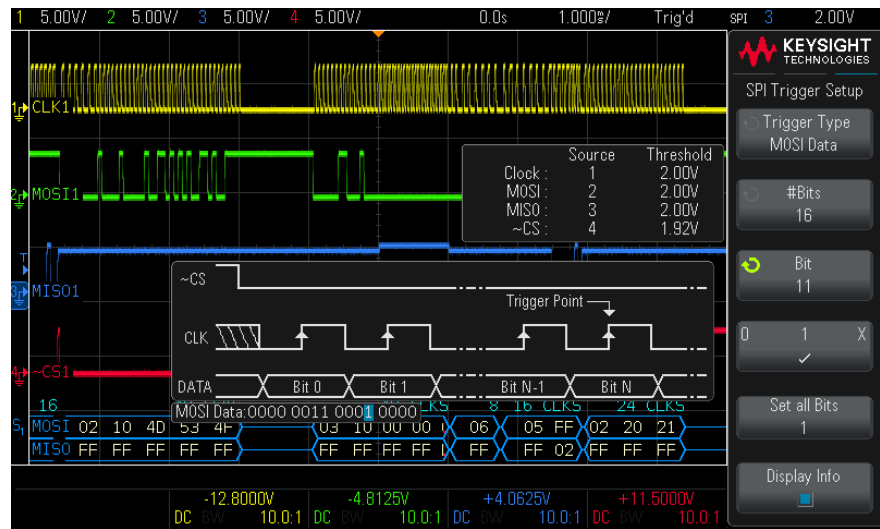
7 For each bit in the MOSI/MISO Data string:

a Press the **Bit** softkey; then, turn the Entry knob to select the bit location.

As you rotate the Entry knob, the bit is highlighted in the Data string shown in the waveform area.

b Press the **0 1 X** softkey to set the bit selected in the **Bit** softkey to **0** (low), **1** (high), or **X** (don't care).





The **Set all Bits** softkey will set all bits in the data string to the value of the **0 1 X** softkey.

For SPI decode information see "[SPI Serial Decode](#)" on page 311.

## SPI Serial Decode

To set up the oscilloscope to capture SPI signals, see "[Setup for SPI Signals](#)" on page 303.

For SPI triggering setup see "[SPI Triggering](#)" on page 309.

To set up SPI serial decode:

- 1 Press the **[Analyze]** key.
- 2 Press **Features**; then, select **Serial Bus**.
- 3 Press **Features** again (or push the Entry knob) to enable the serial bus display.

- 4 Press the **Mode** softkey; then, select **SPI**.
- 5 Press the **Word Size** softkey; then, turn the Entry knob to select the number of bits in a word.
- 6 Press the **Bit Order** softkey; then turn the Entry knob to select the bit order, most significant bit first (MSB) or least significant bit first (LSB), used when displaying data in the serial decode waveform.
- 7 If the oscilloscope is stopped, press the **[Run/Stop]** key to acquire and decode data.

**NOTE**

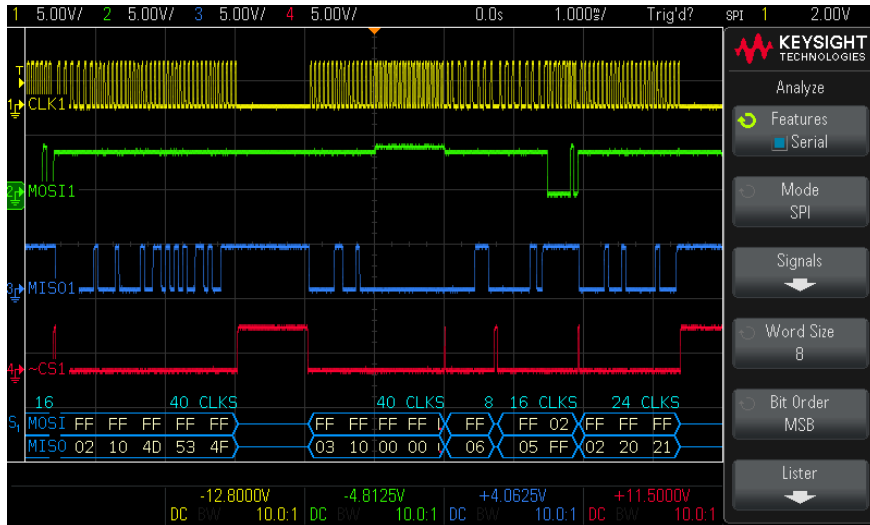
If the setup does not produce a stable trigger, the SPI signal may be slow enough that the oscilloscope is auto-triggering. Press the **[Trigger]** key, then press the **Mode** softkey to set the trigger mode from **Auto** to **Normal**.

You can use the horizontal **Zoom** window for easier navigation of the acquired data.

- See Also
- ["Interpreting SPI Decode"](#) on page 313
  - ["Interpreting SPI Lister Data"](#) on page 314

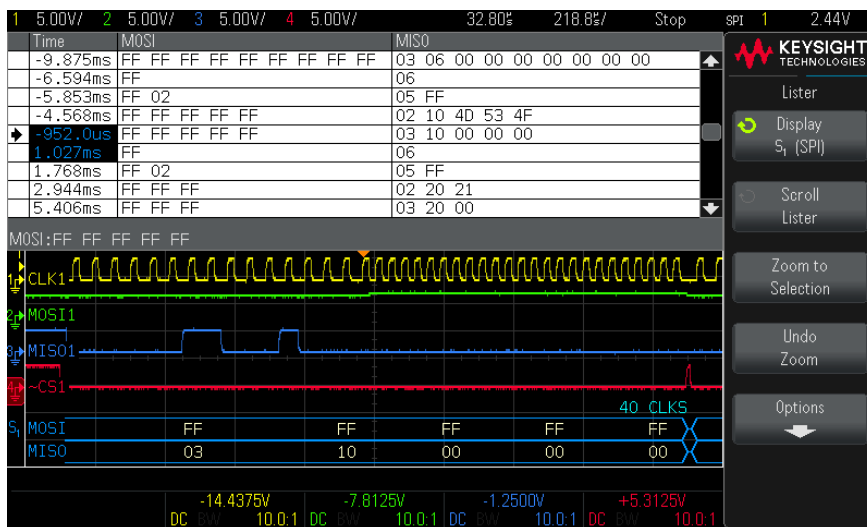


## Interpreting SPI Decode



- Angled waveforms show an active bus (inside a packet/frame).
- Mid-level blue lines show an idle bus.
- The number of clocks in a frame appears in light-blue above the frame, to the right.
- Decoded hexadecimal data values appear in white.
- Decoded text is truncated at the end of the associated frame when there is insufficient space within frame boundaries.
- Pink vertical bars indicate you need to expand the horizontal scale (and run again) to see decode.
- Red dots in the decode line indicate that there is data that is not being displayed. Scroll or expand the horizontal scale to view the information.
- Aliased bus values (undersampled or indeterminate) are drawn in pink.
- Unknown bus values (undefined or error conditions) are drawn in red.

## Interpreting SPI Lister Data



In addition to the standard Time column, the SPI Lister contains these columns:

- Data – data bytes (MOSI and MISO).

Aliased data is highlighted in pink. When this happens, decrease the horizontal time/div setting and run again.

# 29 UART/RS232 Triggering and Serial Decode

Setup for UART/RS232 Signals / 315

UART/RS232 Triggering / 317

UART/RS232 Serial Decode / 320

UART/RS232 triggering and serial decode is available on DSOX1200-Series and EDUX1052A/G oscilloscopes.

## Setup for UART/RS232 Signals

To set up the oscilloscope to capture UART/RS232 signals:

- 1 Press **[Display]** > **Labels** > **Display** to turn on labels.
- 2 Press the **[Analyze]** key.
- 3 Press **Features**; then, select **Serial Bus**.
- 4 Press **Features** again (or push the Entry knob) to enable the serial bus display.
- 5 Press the **Mode** softkey; then, select **UART/RS232**.

6 Press the **Signals** softkey to open the UART Signals menu.

7 For both the Rx and Tx signals:

- a Connect an oscilloscope channel to the signal in the device under test.
- b Press the **Rx** or **Tx** softkey; then, turn the Entry knob to select the channel for the signal.
- c Press the corresponding **Threshold** softkey; then, turn the Entry knob to select the signal threshold voltage level.

The threshold voltage level is used in decoding, and it will become the trigger level when the trigger type is set to the selected serial decode slot.

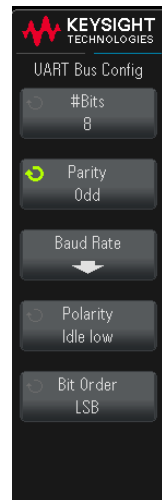
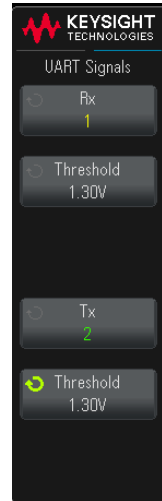
The RX and TX labels for the source channels are automatically set.

8 Press the  Back key to return to the Analyze menu.

9 Press the **Bus Config** softkey to open the UART Bus Config menu.

Set the following parameters.

- a **#Bits** – Set the number of bits in the UART/RS232 words to match your device under test (selectable from 5-9 bits).
- b **Parity** – Choose odd, even, or none, based on your device under test.
- c **Baud** – Press the **Baud Rate** softkey, then press the **Baud** softkey and select a baud rate to match the signal in your device under test. If the desired baud rate is not listed, select **User Defined** on the Baud softkey; then, select the desired baud rate using the **User Baud** softkey.



You can set the UART baud rate from 1.2 kb/s to 10.0000 Mb/s in increments of 100 b/s.

- d Polarity** – Select idle low or idle high to match your device under test's state when at idle. For RS232 select idle low.
- e Bit Order** – Select whether the most significant bit (MSB) or the least significant bit (LSB) is presented after the start bit in the signal from your device under test. For RS232 select LSB.

**NOTE**

In the serial decode display, the most significant bit is always displayed on the left regardless of how Bit Order is set.

---

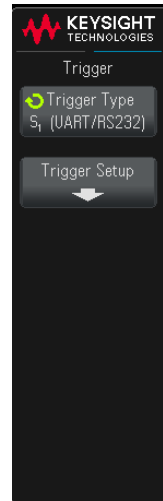
## UART/RS232 Triggering

To set up the oscilloscope to capture UART/RS-232 signals, see "[Setup for UART/RS232 Signals](#)" on page 315.

To trigger on a UART (Universal Asynchronous Receiver/Transmitter) signal connect the oscilloscope to the Rx and Tx lines and set up a trigger condition. RS232 (Recommended Standard 232) is one example of a UART protocol.

- 1** Press **[Trigger]**.
- 2** In the Trigger menu, press the **Trigger Type** softkey.

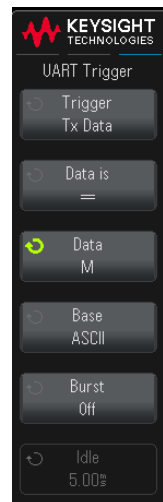
- 3 Press the **Trigger Type** softkey; then, turn the Entry knob to select the serial slot (Serial 1) on which the UART/RS232 signals are being decoded.
- 4 Press the **Trigger Setup** softkey to open the UART Trigger menu.



- 5 Press the **Base** softkey to select Hex or ASCII as the base displayed on the Data softkey in the UART Trigger menu.

Note that the setting of this softkey does not affect the selected base of the decode display.

- 6 Press the **Trigger** softkey and set up the desired trigger condition:
  - **Rx Start Bit** – The oscilloscope triggers when a start bit occurs on Rx.
  - **Rx Stop Bit** – Triggers when a stop bit occurs on Rx. The trigger will occur on the first stop bit. This is done automatically whether the device under test uses 1, 1.5, or 2 stop bits. You do not need to specify the number of stop bits used by the device Under test.
  - **Rx Data** – Triggers on a data byte that you specify. For use when the device under test data words are from 5 to 8 bits in length (no 9th (alert) bit).



- **Rx 1:Data** – For use when the device under test data words are 9 bits in length including the alert bit (the 9th bit). Triggers only when the 9th (alert) bit is 1. The specified data byte applies to the least significant 8 bits (excludes the 9th (alert) bit).
  - **Rx 0:Data** – For use when the device under test data words are 9 bits in length including the alert bit (the 9th bit). Triggers only when the 9th (alert) bit is 0. The specified data byte applies to the least significant 8 bits (excludes the 9th (alert) bit).
  - **Rx X:Data** – For use when the device under test data words are 9 bits in length including the alert bit (the 9th bit). Triggers on a data byte that you specify regardless of the value of the 9th (alert) bit. The specified data byte applies to the least significant 8 bits (excludes the 9th (alert) bit).
  - Similar choices are available for Tx.
  - **Rx or Tx Parity Error** – Triggers on a parity error based on the parity you have set in the UART Bus Config menu.
- 7 If you choose a trigger condition that includes "**Data**" in its description (for example: **Rx Data**), then press the **Data is** softkey, and choose an equality qualifier. You can choose equal to, not equal to, less than, or greater than a specific data value.
  - 8 Use the **Data** softkey to choose the data value for your trigger comparison. This works in conjunction with the **Data is** softkey.
  - 9 Optional: The **Burst** softkey lets you trigger on the Nth frame (1-4096) after an idle time you select. All trigger conditions must be met for the trigger to occur.
  - 10 If **Burst** is selected, an idle time (1  $\mu$ s to 10 s) can be specified so that the oscilloscope will look for a trigger condition only after the idle time has past. Press the **Idle** softkey and rotate the Entry knob to set an idle time.

**NOTE**

If the setup does not produce a stable trigger, the UART/RS232 signals may be slow enough that the oscilloscope is auto-triggering. Press the **[Trigger]** key, then press the **Mode** softkey to set the trigger mode from **Auto** to **Normal**.

To display UART/RS232 serial decode, see "**UART/RS232 Serial Decode**" on page 320.

## UART/RS232 Serial Decode

To set up the oscilloscope to capture UART/RS232 signals, see "[Setup for UART/RS232 Signals](#)" on page 315.

For UART/RS232 triggering setup see "[UART/RS232 Triggering](#)" on page 317.

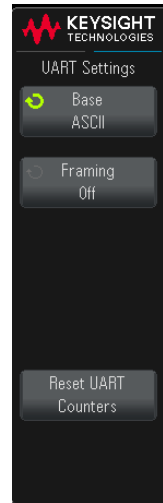
To set up UART/RS232 serial decode:

- 1 Press the **[Analyze]** key.
- 2 Press **Features**; then, select **Serial Bus**.
- 3 Press **Features** again (or push the Entry knob) to enable the serial bus display.
- 4 Press the **Mode** softkey; then, select **UART/RS232**.
- 5 Press **Settings**.





- 6 In the UART Settings menu, press the **Base** softkey to select the base (hex, binary, or ASCII) in which decoded words are displayed.
- When displaying words in ASCII, the 7-bit ASCII format is used. Valid ASCII characters are between 0x00 and 0x7F. To display in ASCII you must select at least 7 bits in the Bus Configuration. If ASCII is selected and the data exceeds 0x7F, the data is displayed in hex.
  - When **#Bits** is set to 9 in the UART Bus Config menu, the 9th (alert) bit is displayed directly to the left of the ASCII value (which is derived from the lower 8 bits).
- 7 Optional: Press the **Framing** softkey and select a value. In the decode display, the chosen value will be displayed in light blue. However, if a parity error occurs the data will be displayed in red.
- 8 If the oscilloscope is stopped, press the **[Run/Stop]** key to acquire and decode data.



## NOTE

If the setup does not produce a stable trigger, the UART/RS232 signals may be slow enough that the oscilloscope is auto-triggering. Press the **[Trigger]** key, then press the **Mode** softkey to set the trigger mode from **Auto** to **Normal**.

You can use the horizontal **Zoom** window for easier navigation of the acquired data.

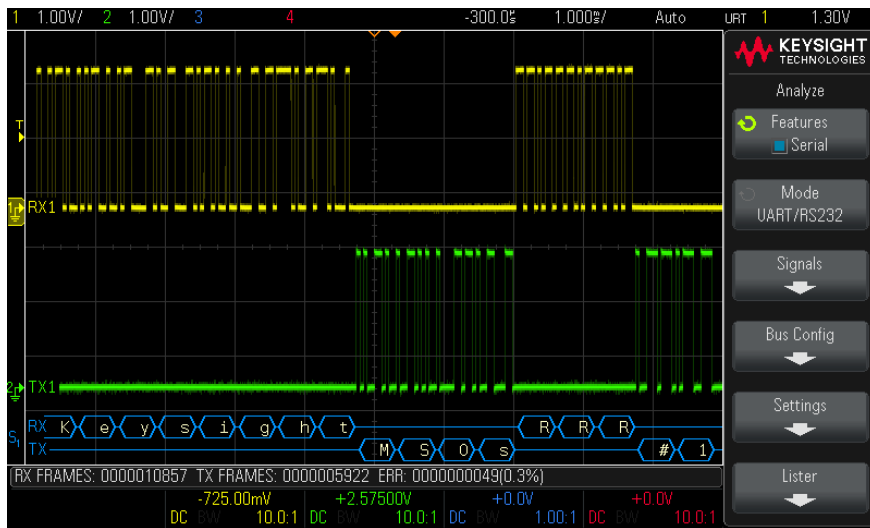
- See Also
- ["Interpreting UART/RS232 Decode"](#) on page 322
  - ["UART/RS232 Totalizer"](#) on page 323
  - ["Interpreting UART/RS232 Lister Data"](#) on page 324



- A parity error will cause the associated data word to be shown in red, which includes the 5-8 data bits and the optional 9th bit.

## UART/RS232 Totalizer

The UART/RS232 totalizer consists of counters that provide a direct measure of bus quality and efficiency. The totalizer appears on screen whenever UART/RS232 Decode is ON in the Analyze menu.

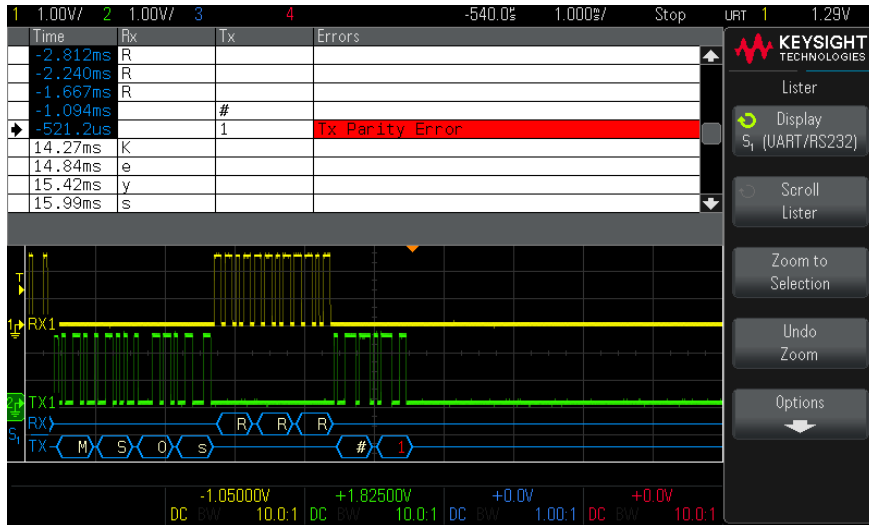


The totalizer is running, counting frames and calculating the percentage of error frames, even when the oscilloscope is stopped (not acquiring data).

The ERR (error) counter is a count of Rx and Tx frames with parity errors. The TX FRAMES and RX FRAMES counts include both normal frames and frames with parity errors. When an overflow condition occurs, the counter displays **OVERFLOW**.

The counters can be reset to zero by pressing the **Reset UART Counters** softkey in the UART Settings menu.

## Interpreting UART/RS232 Lister Data



In addition to the standard Time column, the UART/RS232 Lister contains these columns:

- Rx – receive data.
- Tx – transmit data.
- Errors – highlighted in red, Parity Error or Unknown Error.

Aliased data is highlighted in pink. When this happens, decrease the horizontal time/div setting and run again.

# Index

## Symbols

- (-) Width measurement, 169
- (+) Width measurement, 169

## A

- About Oscilloscope, 247
- AC channel coupling, 50
- AC RMS - Full Screen measurement, 165
- AC RMS - N Cycles measurement, 165
- accessories, 21, 265, 266
- acquire, 129, 139
- Acquire key, 29, 37, 42, 44, 138
- Acquisition controls, 29
- acquisition memory, 98
- acquisition memory, saving, 221
- acquisition mode, 135
- acquisition mode, averaging, 138, 139
- acquisition mode, high resolution, 140
- acquisition mode, normal, 136
- acquisition mode, peak detect, 136
- acquisition mode, preserve during Autoscale, 241
- acquisition modes, 129
- active serial bus, 282, 293, 301, 313, 322
- actual sample rate, 134
- addition math function, 68
- address with no ack condition, I2C trigger, 289
- Addresses softkey, 235
- aliasing, 131
- aliasing, FFT, 62
- alternating edge trigger, 101
- altitude (environmental conditions), 265
- AM (amplitude modulation), waveform generator output, 211
- Amplitude measurement, 161

- amplitude modulation (AM), waveform generator output, 211
- analog bus display, 55
- analog channel, probe attenuation, 52
- analog channel, setup, 47
- analog filters, adjusting, 57, 71
- Analyze key, 30
- Analyze Segments, 141, 142, 180
- annotation, adding, 87
- ASCII file format, 218
- attenuation, probe, 52
- attenuation, probe, external trigger, 128
- Auto Increment, 224
- Auto Scale key, 29
- Auto Setup, FFT, 58, 71, 73
- Auto trigger mode, 122
- Auto? trigger indicator, 123
- AutoIP, 235, 236
- automatic measurements, 155, 157
- Autoscale, 24
- Autoscale preferences, 241
- Autoscale, undo, 25
- Average - Full Screen measurement, 164
- Average - N Cycles measurement, 164
- averaging acquire mode, 135, 138, 139

## B

- Back key, 28
- bandwidth, 247
- bandwidth limit, 50
- bandwidth required, oscilloscope, 134
- bandwidth, oscilloscope, 131
- Base measurement, 162
- BIN file format, 218
- binary data (.bin), 266
- binary data file examples, 270
- binary data in MATLAB, 267

- binary data, example program for reading, 270
- bit rate measurement, 169
- bits, SPI trigger, 310
- Blackman Harris FFT window, 58, 72
- blanking, 43
- BMP file format, 218
- Bode plot, frequency response analysis, 202
- brick-wall frequency response, 132
- brightness of waveforms, 28
- Browser Web Control, 254, 255
- built-in help, 36
- burst, capture signal bursts, 141
- Bus key, 55
- buttons (keys), front panel, 26
- BW Limit? in DVM display, 196

## C

- calibration, 245
- calibration protect button, 33
- calibration status, 260
- CAN decode, source channels, 278
- CAN frame counter, 283
- CAN serial decode, 281
- CAN totalizer, 283
- CAN trigger, 279
- capture signal bursts, 141
- Center, FFT, 57, 72
- change network password, 262
- channel labels, 91
- channel, analog, 47
- channel, bandwidth limit, 50
- channel, coupling, 50
- channel, invert, 51
- channel, on/off keys, 31
- channel, position, 49
- channel, probe units, 52
- channel, skew, 53
- channel, vernier, 31, 51
- channel, vertical sensitivity, 49

- characteristics, 263
  - choosing values, 28
  - cleaning, 247
  - clear display, 138
  - clear display, Quick Clear Display, 249
  - clear persistence, 85
  - clock, 242
  - compensate passive probes, 25, 32
  - Config softkey, 235, 236
  - Conformity, Declaration of, 265
  - connection, to a PC, 236
  - connections for frequency response analysis (FRA), 199
  - connectors, rear panel, 33
  - Control Instrument, 253
  - control, remote, 233
  - controls, front panel, 26
  - copyright, 2
  - Counter measurement, 169
  - counter, CAN frame, 283
  - counter, UART/RS232 frame, 323
  - coupling, channel, 50
  - coupling, trigger, 124
  - crash log files, export, 246
  - crosstalk between input channels, minimizing, 48
  - crosstalk problems, 57, 71
  - CSV file format, 218
  - CSV files, minimum and maximum values, 274
  - cursor measurements, 145
  - cursor units, 149
  - Cursors key, 30
  - Cursors knob, 30
  - cursors, binary, 147
  - cursors, hex, 148
  - cursors, manual, 147
  - cursors, track waveform, 147
- D**
- damage, shipping, 21
  - data sheet, 263
  - DC channel coupling, 50
  - DC RMS - Full Screen measurement, 165
  - DC RMS - N Cycles measurement, 165
  - DC signals, checking, 123
  - DC waveform generator output, 207
- E**
- dead time (re-arm), 142
  - decibels, FFT vertical units, 58, 72
  - decimating samples, 135
  - decimation, for measurement record, 274
  - decimation, for screen, 274
  - Declaration of Conformity, 265
  - default configuration, 24
  - default label library, 95
  - default setup, 24, 226
  - Default Setup key, 29
  - defaults, waveform generator, 215
  - delay knob, 39
  - Delay measurement, 158, 170
  - delay time indicator, 46
  - delayed sweep, 44
  - delete character, 224
  - delete file, 236
  - Demo terminal, 32
  - depth, AM modulation, 212
  - deviation, FM modulation, 213
  - DHCP, 235, 236
  - digital voltmeter (DVM), 195
  - digital waveform, external trigger input, 128
  - disable network password, 262
  - Display key, 30
  - display multiple acquisitions, 130
  - display, area, 35
  - display, interpreting, 34
  - display, persistence, 85
  - display, signal detail, 83
  - display, softkey labels, 36
  - display, status line, 35
  - displayed channels Autoscale, 241
  - distortion problems, 57, 71
  - Divide math function, 69
  - DNS IP, 235
  - Duty cycle measurement, 170
  - DVM (digital voltmeter), 195
- E**
- edge speeds, 134
  - edge triggering, 99
  - EEPROM data read, I2C trigger, 289
  - either edge trigger, 101
  - eject USB storage device, 238
  - Entry knob, 28
- F**
- Entry knob, push to select, 28
  - environmental conditions, 265
  - erase, secure, 226
  - exFAT file system format not supported, 238
  - expand about, 31, 49, 239
  - expand about center, 239
  - expand about ground, 239
  - exporting waveform, 217
  - EXT TRIG input as Z-axis input, 43
  - EXT TRIG input connector, 34
  - Ext Trig input connector, 33
  - EXT2 file system format, 238
  - EXT3 file system format, 238
  - EXT4 file system format, 238
  - External key, 33
  - external memory device, 33
  - external trigger, 127
  - external trigger, digital waveform, 128
  - external trigger, input impedance, 127
  - external trigger, input signal range, 128
  - external trigger, input signal threshold, 128
  - external trigger, probe attenuation, 128
  - external trigger, probe units, 128
- F**
- f(t), 67
  - factory default settings, 226
  - Fall time measurement, 170
  - falling edges count measurements, 175
  - fast debug Autoscale, 241
  - FAT file system format, 238
  - FAT16 file system format, 238
  - FAT32 file system format, 238
  - FFT aliasing, 62
  - FFT DC value, 61
  - FFT key, 31
  - FFT magnitude math function, 70
  - FFT math function, 57
  - FFT measurement hints, 60
  - FFT phase math function, 70
  - FFT resolution, 60
  - FFT spectral leakage, 63
  - FFT units, 61

FFT vertical units, [58, 72](#)  
 FFT window, [58, 72](#)  
 file explorer, [236](#)  
 file format, ASCII, [218](#)  
 file format, BIN, [218](#)  
 file format, BMP, [218](#)  
 file format, CSV, [218](#)  
 file format, PNG, [218](#)  
 file name, new, [224](#)  
 file, save, recall, load, [236](#)  
 filter math function, low pass, [74](#)  
 filters, math, [74](#)  
 fine adjustment, horizontal scale, [45](#)  
 firmware updates, [266](#)  
 firmware version information, [251](#)  
 firmware versions, [260](#)  
 flash drive, [33](#)  
 Flat top FFT window, [58, 72](#)  
 FM (frequency modulation), waveform generator output, [212](#)  
 folding frequency, [131](#)  
 Force key, [31](#)  
 forcing a trigger, [99](#)  
 FRA (frequency response analysis), [199](#)  
 frame trigger, I2C, [290](#)  
 freeze display, [249](#)  
 freeze display, Quick Freeze Display, [249](#)  
 frequency deviation, FM modulation, [213](#)  
 Frequency measurement, [168](#)  
 frequency modulation (FM), waveform generator output, [212](#)  
 frequency requirements, power source, [22](#)  
 frequency response analysis (FRA), [199](#)  
 frequency response analysis data, save, [204](#)  
 frequency, Nyquist, [131](#)  
 frequency-shift keying modulation (FSK), waveform generator output, [214](#)  
 front panel controls and connectors, [26](#)  
 front panel self test, [246](#)  
 front panel, language overlay, [33](#)  
 front panel, remote, [254](#)  
 FSK (frequency-shift keying modulation), waveform generator output, [214](#)

## G

g(t), [67](#)  
 gateway IP, [235](#)  
 Gaussian frequency response, [132](#)  
 Gen Out connector, [242](#)  
 glitch capture, [136](#)  
 glitch trigger, [102](#)  
 golden waveform test, [181](#)  
 graphical user interface language, [36](#)  
 graticule intensity, [87](#)  
 graticule type, [86](#)  
 grid intensity, [87](#)  
 grid type, [86](#)  
 ground level, [48](#)  
 Ground terminal, [32](#)

## H

Hanning FFT window, [58, 72](#)  
 hardware self test, [246](#)  
 Help key, [32](#)  
 help, built-in, [36](#)  
 HF Reject, [125](#)  
 high-frequency noise rejection, [125](#)  
 high-resolution mode, [135, 140](#)  
 holdoff, [126](#)  
 hop frequency, FSK modulation, [214](#)  
 Horizontal controls, [29, 37, 40](#)  
 Horizontal knobs and keys, [37](#)  
 horizontal position control, [29](#)  
 horizontal position knob, [39](#)  
 horizontal scale fine adjustment, [45](#)  
 horizontal time/div control, [29](#)  
 horizontal Zoom key, [29](#)  
 Host ID, [247](#)  
 host name, [235, 251](#)  
 Host name softkey, [235](#)  
 humidity (environmental conditions), [265](#)

## I

I/O interface settings, [233](#)  
 I2C serial decode, [292](#)  
 I2C trigger, [288](#)  
 identification function, web interface, [259](#)

idle serial bus, [282, 293, 301, 313, 322](#)  
 increment statistics, [180](#)  
 indeterminate state, [148](#)  
 infinite persistence, [85, 130, 136](#)  
 information area, [36](#)  
 installed licenses, [247](#)  
 installed options, [260](#)  
 Instrument Utilities web page, [260](#)  
 intensity control, [83](#)  
 Intensity key, [28](#)  
 invert graticule colors, [219](#)  
 invert waveform, [51](#)  
 IP address, [235, 251](#)

## K

keyboard, USB, [88, 94, 224, 231, 240](#)  
 keys, front panel, [26](#)  
 Keysight IO Libraries Suite, [256](#)  
 knobs, front panel, [26](#)

## L

label list, [95](#)  
 label list, loading from text file, [94](#)  
 labels, [91](#)  
 labels, auto-increment, [94](#)  
 labels, default library, [95](#)  
 LAN connection, [235](#)  
 LAN interface, remote control, [233](#)  
 LAN port, [34](#)  
 LAN Settings softkey, [235, 236](#)  
 landscape mode, [232](#)  
 language, user interface and Quick Help, [36](#)  
 length control, [221](#)  
 length softkey, [220](#)  
 Level knob, [31](#)  
 level, trigger, [99](#)  
 LF Reject, [124](#)  
 library, labels, [93](#)  
 LIN serial decode, [299](#)  
 LIN trigger, [297](#)  
 line voltage, [22](#)  
 load file, [236](#)  
 Load from, [223](#)  
 localized front panel overlay, [33](#)  
 Location, [223, 237](#)

logging remote commands, 243  
 logic presets, waveform generator, 209  
 low pass filter math function, 74  
 low-frequency noise rejection, 124

## M

markings, product, 275  
 mask files, recall, 225  
 Mask Statistics Reset, 249  
 mask statistics reset, Quick Mask Statistics Reset, 249  
 mask test, trigger output, 185, 243  
 mask testing, 181  
 mask, Gen Out signal, 243  
 math filters, 74  
 Math function controls, 32  
 Math key, 32  
 math operators, 68  
 math transforms, 70  
 math, 1\*2, 69  
 math, 1/2, 69  
 math, addition, 68  
 math, divide, 69  
 math, FFT, 57  
 math, FFT magnitude/phase, 70  
 math, functions, 65  
 math, multiply, 69  
 math, offset, 67  
 math, scale, 67  
 math, subtract, 68  
 math, transform functions on arithmetic operations, 67  
 math, units, 67  
 math, using waveform math, 66  
 MATLAB binary data, 267  
 maximum input voltages, 264  
 Maximum measurement, 160  
 maximum sample rate, 134  
 Meas key, 30, 155  
 Measure controls, 30  
 measure, Quick Measure All, 249  
 measurement category, definitions, 264  
 measurement definitions, 157  
 measurement record, 221  
 measurement statistics, 178  
 measurement thresholds, 175

measurement window with zoom display, 177  
 measurements, 157  
 measurements area, 36  
 measurements, automatic, 155  
 measurements, delay, 158  
 measurements, overshoot, 158  
 measurements, phase, 158  
 measurements, preshoot, 158  
 measurements, time, 167  
 measurements, voltage, 160  
 memory depth and sample rate, 134  
 memory, segmented, 141  
 menu name, 36  
 menu timeout, softkey, 36  
 Minimum measurement, 161  
 missing acknowledge condition, I2C trigger, 289  
 model number, 247, 251  
 Modify softkey, 235  
 modulation, waveform generator output, 210  
 Multicast DNS, 235  
 Multiply math function, 69

## N

N8900A Infiniium Offline oscilloscope analysis software, 218  
 navigate files, 236  
 network configuration parameters, 251  
 network printer connection, 231  
 network, connecting to, 235  
 new label, 93  
 noise rejection, 125  
 noise waveform generator output, 207  
 noise, adding to waveform generator output, 209  
 noise, high-frequency, 125  
 noise, low-frequency, 124  
 noisy signals, 122  
 non-volatile memory, secure erase, 226  
 normal acquire mode, 136  
 normal mode, 135, 136  
 Normal trigger mode, 122  
 notices, 2  
 NTFS file system format, 238

number of negative pulses measurements, 174  
 number of positive pulses measurements, 174  
 Nyquist frequency, 62  
 Nyquist sampling theory, 131

## O

operators, math, 68  
 options, print, 232  
 oscilloscope bandwidth, 131  
 oscilloscope bandwidth required, 134  
 oscilloscope rise time, 133  
 oscilloscope sample rate, 133  
 output load expected, waveform generator, 208  
 output, trigger, 242  
 overdrive on input channels, avoiding, 48  
 overlay, localized, 33  
 Overshoot measurement, 158, 162  
 overvoltage category, 265

## P

palette, 219  
 pan and zoom, 38  
 passive probes, compensating, 25  
 password (network), change or disable, 262  
 password (network), setting, 261  
 pattern trigger, 104  
 pattern, SPI trigger, 310  
 PC connection, 236  
 peak detect mode, 135, 136  
 Peak-peak measurement, 160  
 Period measurement, 167  
 persistence, 85  
 persistence, clearing, 85  
 persistence, infinite, 130  
 Phase measurement, 158, 171  
 phase X cursor units, 149  
 PNG file format, 218  
 point-to-point connection, 236  
 pollution degree, 265  
 pollution degree, definitions, 265  
 position, analog, 49  
 post-processing, 155



post-trigger information, 39  
 power consumption, 22  
 power cord connector, 34  
 power requirements, 22  
 power supply, 34  
 power switch, 22, 28  
 power-on, 22  
 predefined labels, 92  
 Preshoot measurement, 158, 163  
 Press to go, 223, 237  
 pre-trigger information, 39  
 print, 249  
 print options, 232  
 print screen, 229  
 print, landscape, 232  
 print, Quick Print, 249  
 printer, USB, 33, 229  
 printing the display, 229  
 probe attenuation, 52  
 probe attenuation, external  
   trigger, 128  
 probe check, 52  
 probe compensation, 32  
 probe compensation, 10:1 setting  
   required, 26  
 probe units, 52  
 probes, 265, 266  
 probes, connecting to oscilloscope, 23  
 probes, passive, compensating, 25  
 programmer's guide, 256  
 pulse polarity, 103  
 pulse waveform generator output, 207  
 pulse width trigger, 102

## Q

qualifier, pulse width, 103  
 Quick Action key, 30, 248  
 Quick Clear Display, 249  
 Quick Freeze Display, 249  
 Quick Help, 36  
 Quick Help language, 36  
 Quick Measure All, 249  
 Quick Print, 249  
 Quick Print quick action, 229  
 Quick Recall, 249  
 Quick Save, 249  
 Quick Trigger Mode, 249

## R

ramp waveform generator output, 207  
 random noise, 122  
 range, external trigger input, 128  
 ratio X cursor units, 149  
 ratio Y cursor units, 149  
 raw acquisition record, 221  
 rear panel connectors, 33  
 re-arm time, 142  
 recall, 249  
 recall files via web interface, 258  
 recall mask files, 225  
 recall setups, 225  
 recall, Quick Recall, 249  
 Rectangular FFT window, 58, 72  
 reference point, waveform, 239  
 reference waveforms, 77  
 regulatory information, 275  
 remote commands, logging, 243  
 remote control, 233  
 Remote Front Panel, 254, 255  
 remote programming, Keysight IO  
   Libraries, 256  
 remote programming, web  
   interface, 254  
 required oscilloscope bandwidth, 134  
 restart condition, I2C trigger, 289  
 results, frequency response analysis  
   (FRA), 202  
 return instrument for service, 248  
 Rise time measurement, 170  
 rise time, oscilloscope, 133  
 rise time, signal, 134  
 rise/fall time triggering, 106  
 rising edge count measurements, 175  
 roll mode, 41  
 RS232 trigger, 317  
 Run Control keys, 29  
 runt pulses, 167

## S

safety warning, 23  
 sample rate, 5  
 sample rate and memory depth, 134  
 sample rate, current rate displayed, 38  
 sample rate, oscilloscope, 132, 133  
 sampling theory, 131

sampling, overview, 130  
 save, 249  
 save file, 236  
 save files via web interface, 257  
 save segment, 220  
 save setup files, 219  
 save times, data, 221  
 Save to, 223  
 Save to USB key, 30  
 save, Quick Save, 249  
 save/recall from web interface, 257  
 Save/Recall key, 30  
 saver, screen, 239  
 saving data, 217  
 SCL, I2C trigger, 288  
 SCPI Commands window, 255  
 screen image via web interface, 256  
 screen saver, 239  
 SDA, 287  
 SDA, I2C trigger, 288  
 secure erase, 226  
 segmented memory, 141  
 segmented memory, re-arm time, 142  
 segmented memory, saving  
   segments, 220  
 Selected, 237  
 selecting, values, 28  
 self test, front panel, 246  
 self test, hardware, 246  
 serial clock, I2C trigger, 288  
 serial data, 287  
 serial data, I2C trigger, 288  
 serial decode controls, 30  
 serial number, 247, 251  
 service functions, 245  
 setup and hold triggering, 107  
 setup files, saving, 219  
 setup, default, 24  
 setup, frequency response analysis  
   (FRA), 200  
 setups, recall, 225  
 shipping damage, 21  
 shipping precautions, 248  
 Sigma, minimum, 184  
 sine waveform generator output, 207  
 single acquisition, 29  
 Single key, 129  
 single-shot acquisitions, 123  
 single-shot events, 129

skew, analog channel, **53**  
 slope trigger, **99**  
 Snapshot All measurements, **159**  
 snapshot all, quick action, **249**  
 softkey labels, **36**  
 softkeys, **8, 28**  
 software updates, **266**  
 software version, **247**  
 Span, FFT, **57, 72**  
 specifications, **263**  
 spectral leakage, FFT, **63**  
 SPI serial decode, **311**  
 SPI trigger, **309**  
 square waveform generator  
   output, **207**  
 square waves, **132**  
 stand-alone connection, **236**  
 start acquisition, **29**  
 start condition, I2C, **289**  
 statistics, increment, **180**  
 statistics, mask test, **186**  
 statistics, measurement, **178**  
 status line, **35**  
 status, User Cal, **247**  
 Std Deviation measurement, **165**  
 stop acquisition, **29**  
 stop condition, I2C, **289**  
 storage locations, navigate, **223**  
 subnet mask, **235**  
 subtract math function, **68**  
 sweep frequencies, frequency response  
   analysis, **202**

## T

temperature (environmental  
 conditions), **265**  
 template, front panel, **33**  
 test, mask, **181**  
 theory, sampling, **131**  
 threshold voltage, external trigger  
   input, **128**  
 threshold, analog channel  
   measurements, **175**  
 thumb drive, **33**  
 time measurements, **167**  
 time reference indicator, **46**  
 time, re-arm, **142**  
 timebase, **40**

timeout, softkey menu, **36**  
 times for saving data, **221**  
 Tools keys, **30**  
 Top measurement, **161**  
 totalizer, CAN, **283**  
 totalizer, UART/rs232, **323**  
 tracking cursors, **147**  
 transforms, math, **70**  
 Transparent backgrounds, **239**  
 Trig'd trigger indicator, **123**  
 Trig'd? trigger indicator, **123**  
 Trigger controls, **31**  
 trigger coupling, **124**  
 trigger indicator, Auto?, **123**  
 trigger indicator, Trig'd, **123**  
 trigger indicator, Trig'd?, **123**  
 Trigger key, **31**  
 Trigger key, trigger, **121**  
 trigger level, **99**  
 trigger mode, auto or normal, **122**  
 trigger mode, Quick Trigger Mode, **249**  
 trigger output, **242**  
 trigger output, mask test, **185, 243**  
 trigger type, CAN, **279**  
 trigger type, edge, **99**  
 trigger type, glitch, **102**  
 trigger type, I2C, **288**  
 trigger type, LIN, **297**  
 trigger type, pattern, **104**  
 trigger type, pulse width, **102**  
 trigger type, rise/fall time, **106**  
 trigger type, RS232, **317**  
 trigger type, setup and hold, **107**  
 trigger type, slope, **99**  
 trigger type, SPI, **309**  
 trigger type, UART, **317**  
 trigger type, video, **108**  
 trigger types, **31, 97**  
 trigger, definition, **98**  
 trigger, external, **127**  
 trigger, forcing a, **99**  
 trigger, general information, **98**  
 trigger, holdoff, **126**  
 trigger, mode/coupling, **121**  
 trigger, source, **100**  
 triggers, Gen Out signal, **243**  
 turn channel on, **31**

## U

UART totalizer, **323**  
 UART trigger, **317**  
 UART/RS232 frame counter, **323**  
 UART/RS232 serial decode, **320**  
 under-sampled signals, **131**  
 units, cursor, **149**  
 units, external trigger probe, **128**  
 units, math, **67**  
 units, probe, **52**  
 updating software and firmware, **266**  
 USB compatibility mode, **234**  
 USB device not recognized, **233**  
 USB device port, remote control, **34,**  
   **233**  
 USB host port, **33, 229**  
 USB printer, **229**  
 USB printers, supported, **229**  
 USB storage device, **33**  
 USB, CD device, **238**  
 USB, eject device, **33**  
 user cal, **245**  
 user calibration, **245**  
 user interface language, **36**  
 utilities, **233**  
 Utility key, **30**

## V

V RMS, FFT vertical units, **58, 72**  
 values, choosing, **28**  
 variable persistence, **85**  
 ventilation requirements, **22**  
 vernier, channel, **31, 51**  
 Vertical controls, **31**  
 vertical expansion, **31, 49**  
 Vertical knobs and keys, **47**  
 vertical position, **49**  
 vertical position knob, **31, 32**  
 vertical scale knob, **31, 32**  
 vertical sensitivity, **31, 32, 49**  
 Vertical Units, FFT, **58, 72**  
 video trigger, **108**  
 VISA connect string, **251**  
 voltage measurements, **160**

## W

- warranted specifications, 263
- warranty, 2, 247
- Wave Gen key, 31, 32
- waveform generator, 205
- waveform generator amplitude, frequency response analysis, 202
- waveform generator defaults, restoring, 215
- waveform generator expected output load, 208
- waveform generator logic presets, 209
- waveform generator output, 243
- waveform generator, waveform type, 205
- waveform type, waveform generator, 205
- waveform, cursor tracking, 147
- waveform, intensity, 83
- waveform, printing, 229
- waveform, reference point, 239
- waveform, saving/exporting, 217
- web interface, 251
- web interface, accessing, 252
- white noise, adding to waveform generator output, 209
- Width - measurement, 169
- Width + measurement, 169
- Window, FFT, 58, 72

## X

- X at Max Y measurement, 173
- X at Max Y on FFT, 159
- X at Min Y measurement, 173
- X at Min Y on FFT, 159
- XY mode, 41

## Z

- Z-axis blanking, 43
- zoom and pan, 38
- zoom display, measurement window with, 177
- Zoom key, 29

