

HCMD-10-S-03.00-01

(2.54 mm) .100"

IDC SOCKET & TERMINAL CABLE

Mates with:

TSW, MTSW, TST, EW, BST, ZST, MTLW, TSM, EJH-02 (HCSD only)

SPECIFICATIONS

For complete specifications and recommended PCB layouts see www.samtec.com?HCSD or www.samtec.com?HCSS

HCSD, HCSS

Insulator Material: Black Liquid Crystal Polymer
Flammability Rating: UL 94V-0
Insulation Resistance: 5000 MΩ
Temperature Range: -20 °C to +105 °C (Rainbow Cable)
 -40 °C to +105 °C (Gray Cable)
Voltage Rating: 425 VAC/600 VDC
Contact: Phosphor Bronze
Plating: 10 μ" (0.25 μm) Au on contact area, 150 μ" (3.81 μm) Sn on balance over 50 μ" (1.27 μm) Ni.
Lead Size Range: .024" (0.61 mm) SQ to .026" (0.66 mm) SQ
Lead Insertion Depth: .185" (4.70 mm) to .250" (6.35 mm)
Wire: 28 AWG 7/36 stranded Tinned Copper
RoHS Compliant: Yes

SPECIFICATIONS

For complete specifications and recommended PCB layouts see www.samtec.com?HCMD or www.samtec.com?HCMS

HCMD, HCMS

Insulator Material: Black Liquid Crystal Polymer
Flammability Rating: UL 94V-0
Insulation Resistance: 5000 MΩ
Temperature Range: -20 °C to +105 °C (Rainbow Cable)
 -40 °C to +105 °C (Gray Cable)
Voltage Rating: 425 VAC/600 VDC
Terminal: Phosphor Bronze
Plating: Sn over 50 μ" (1.27 μm) Ni
Wire: 28 AWG 7/36 stranded Tinned Copper
RoHS Compliant: Yes

Note: IDC assemblies are non-standard, non-returnable.

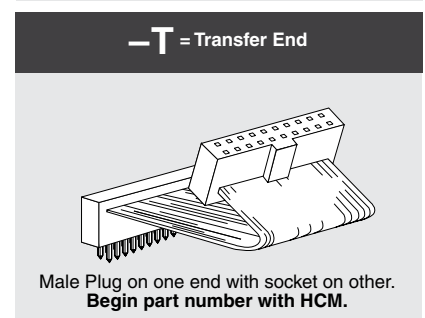
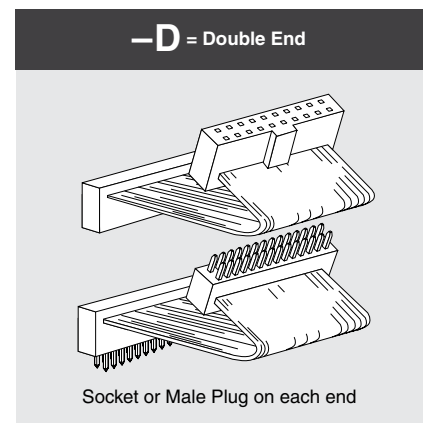
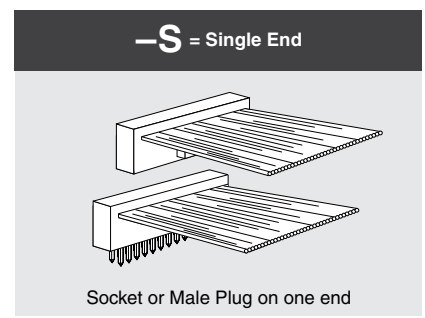
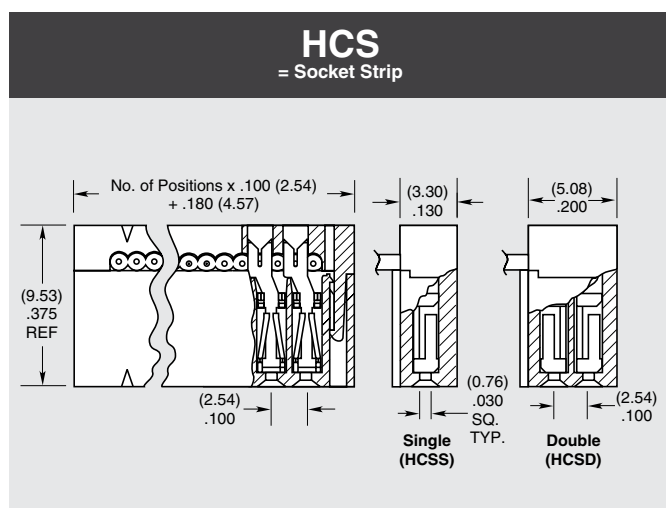
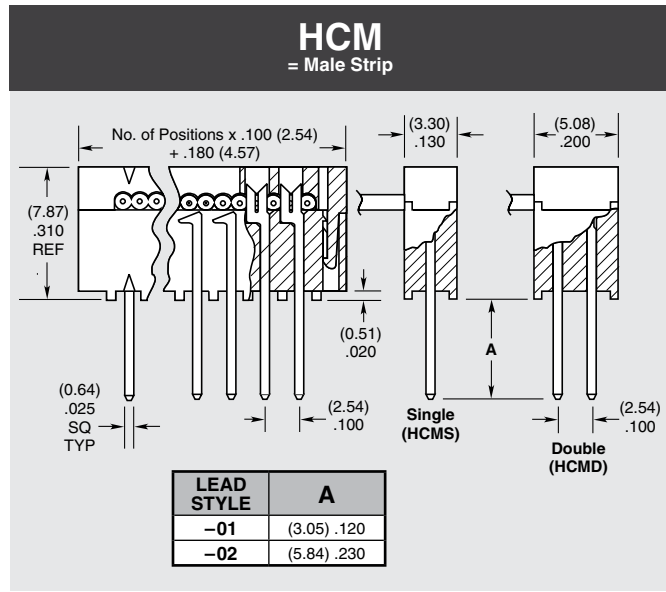
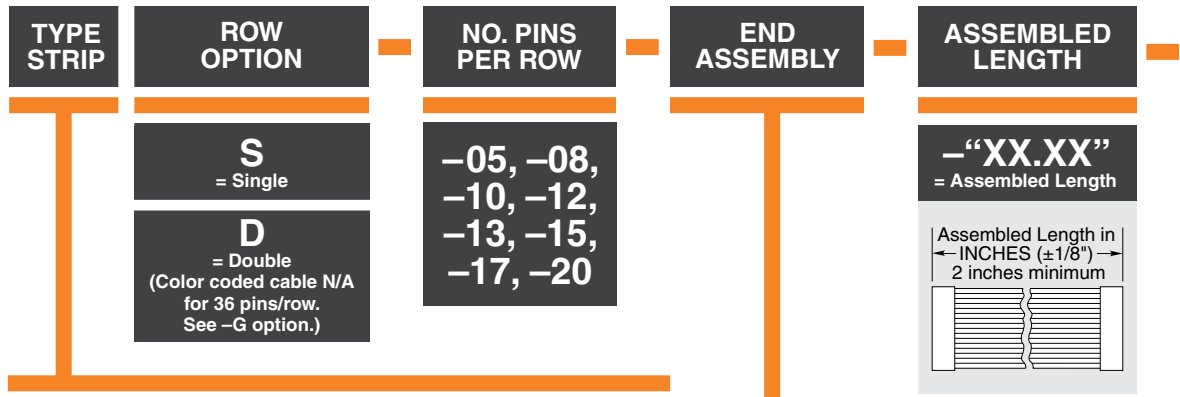

Due to technical progress, all designs, specifications and components are subject to change without notice.

HCSS-15-S-03.00-01-G

HCSD-10-S-03.00-01-T-G

HCMD, HCMS, HCSD, HCSS SERIES

LEAD STYLE

-01
= HCSS/HCSD or
(3.05 mm) .120" tail for
HCMS/HCMD

-02
= (5.84 mm) .230" tail
HCMS/HCMD only

PLATING OPTION

-S
= 10 μ " (0.25 μ m) Gold on contact area or tail,
Tin on balance
(Standard on HCSS & HCSD. Leave blank)

-T
= Tin
(Standard on HCMS & HCMD. Leave blank)

NOTCH POLARIZATION

-N = Notch Polarization

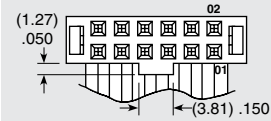

Required for HCSS and HCSD.
(Not available on HCMS or HCMD,
unless Transfer, then only the
socket is polarized.)

OTHER OPTIONS

-P "XX"
= Position Polarization

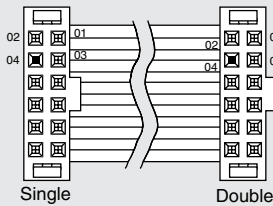

Specify "XX" as position. For Double the same position will be polarized on both ends. (Not available on HCM, unless Transfer, then only the socket is polarized)

-G
= Gray Cable

Standard cable is color coded. Specify -G for Gray cable with one red edge.

-ST "X"
= Stripped & Tinned

Specify Suffix from table. All dimensions are $\pm 1/16$ " (1.59 mm). Not available in 28 positions and higher.

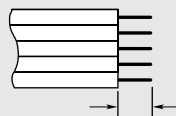

-ST8	1/8" (3.18)
-ST4	1/4" (6.35)
-ST2	1/2" (12.70)
-ST3	3/8" (9.53)

-B "XX"
= Breakout

Specify "XX" as number of conductors to be broken out.

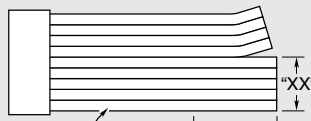

Breakout starts with Number 1 lead indicated by brown wire or red stripe. Shown on top side.

-RW
= Reversed Wiring

#1 wire opposite position #1

-S "XX"
= Daisy Chain Single

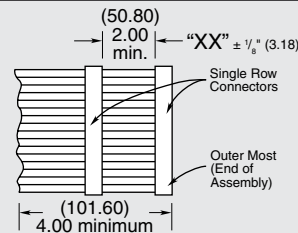

When mating double row connector with two single row connectors, the outer most single will be connected to Conductor #1 and the inside single to Conductor #2.

-D "XX"
= Daisy Chain, Double

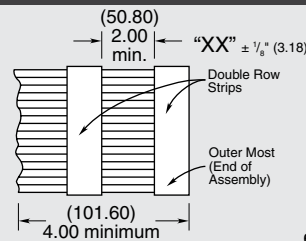

-W "XX"
= Wiring Reversed Daisy Chain, Single

Same as -S "XX" except outer strip connected to conductor #2 and inside strip connected to conductor #1.

-R
= Reversed

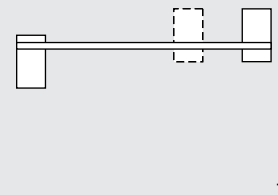

-M
= Middle Reversed

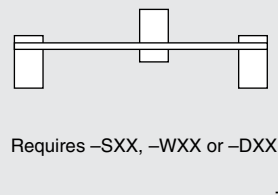

Requires -SXX, -WXX or -DXX

-O
= Outside Reversed

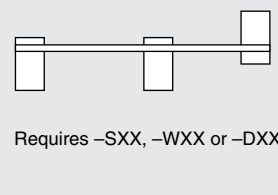

Requires -SXX, -WXX or -DXX

Due to technical progress, all designs, specifications and components are subject to change without notice.

WWW.SAMTEC.COM

All parts within this catalog are built to Samtec's specifications.
Customer specific requirements must be approved by Samtec and identified in a Samtec customer-specific drawing to apply.

Mouser Electronics

Authorized Distributor

Click to View Pricing, Inventory, Delivery & Lifecycle Information:

Samtec:

[HCSD-10-01-N](#) [HCSD-15-01-N](#) [HCSD-17-D-12.00-01-N](#) [HCSD-13-01-N](#) [HCSD-05-D-11.40-01-N-G-R](#) [HCSD-05-D-06.00-01-N](#) [HCSD-05-01-N](#) [HCSD-05-D-10.00-01-N](#) [HCSD-08-01-N](#) [HCSD-20-01-N](#) [HCSD-02-S-06.00-01-ST8](#) [HCSD-02-S-03.00-01-ST8](#) [HCSD-32-01-N](#) [HCSD-32-01-T-N](#) [HCSD-33-01](#) [HCSD-36-01](#) [HCSD-05-D-16.00-01-G-RW](#) [HCSD-08-D-11.00-01-N-R](#) [HCSD-13-D-36.00-01-T](#) [HCSD-30-01-N](#) [HCSD-30-01-T](#) [HCSD-36-01-T-N](#) [HCSD-05-S-12.00-01-T-N-ST8](#) [HCSD-20-S-04.00-01-T-N-G-RW](#) [HCSD-20-D-04.00-01-T-N-G-RW](#) [HCSD-10-D-06.00-01-T-G-RW](#) [HCSD-15-D-50.00-01-N-G](#) [HCSD-17-D-02.00-01-G-RW](#) [HCSD-17-D-08.00-01-T-G-RW](#) [HCSD-17-D-02.00-01-T-N-G-RW](#) [HCSD-20-D-02.00-01-N-R](#) [HCSD-13-S-36.00-01-T-N](#) [HCSD-10-S-20.00-01-N-G-ST4](#) [HCSD-13-S-03.00-01-T](#) [HCSD-17-D-13.78-01-N-G](#) [HCSD-08-D-60.00-01-N-G](#) [HCSD-10-D-16.00-01-N-B10](#) [HCSD-12-D-36.00-01-N-G-R](#) [HCSD-20-D-15.00-01-G](#) [HCSD-20-S-05.00-01](#) [HCSD-20-S-20.00-01](#) [HCSD-24-01-N](#) [HCSD-30-01](#) [HCSD-32-01-T](#) [HCSD-15-D-03.00-01-N-G](#) [HCSD-17-D-02.00-01-T-G](#) [HCSD-05-D-12.00-01-G](#) [HCSD-05-S-10.00-01-T](#) [HCSD-20-D-07.80-01](#) [HCSD-08-D-36.00-01-T](#) [HCSD-13-D-02.00-01-G-R](#) [HCSD-13-D-06.00-01-G-R](#) [HCSD-13-D-06.00-01-T-N](#) [HCSD-15-01](#) [HCSD-15-D-04.50-01-T-G](#) [HCSD-15-D-12.50-01-N](#) [HCSD-17-01-T](#) [HCSD-17-D-18.00-01-N](#) [HCSD-20-D-04.50-01-N-R](#) [HCSD-20-D-12.00-01-N-G](#) [HCSD-20-D-36.00-01-N-G-R](#) [HCSD-20-S-11.00-01-G-ST8](#) [HCSD-20-S-12.00-01-N](#) [HCSD-20-S-16.00-01](#) [HCSD-21-01-T](#) [HCSD-36-01-T](#) [HCSD-15-D-20.00-01-N-G](#) [HCSD-15-D-23.00-01-N](#) [HCSD-15-S-72.00-01-N](#) [HCSD-17-D-04.00-01-R](#) [HCSD-17-D-12.00-01](#) [HCSD-17-D-12.00-01-N-G](#) [HCSD-18-D-17.00-01](#) [HCSD-18-D-24.00-01-G-S02](#) [HCSD-20-D-03.00-01](#) [HCSD-20-D-08.00-01-D02-R](#) [HCSD-20-D-18.00-01-N](#) [HCSD-20-S-24.00-01-N](#) [HCSD-20-S-32.00-01](#) [HCSD-28-01-N](#) [HCSD-28-01-T](#) [HCSD-32-01](#) [HCSD-15-D-36.00-01-N-G](#) [HCSD-17-01](#) [HCSD-17-D-06.00-01](#) [HCSD-17-D-06.00-01-N-G](#) [HCSD-17-D-09.50-01](#) [HCSD-17-D-16.25-01](#) [HCSD-17-S-14.00-01](#) [HCSD-18-01-N](#) [HCSD-20-D-48.00-01-N](#) [HCSD-20-S-10.00-01](#) [HCSD-25-01-N](#) [HCSD-33-01-N](#) [HCSD-36-01-N](#) [HCSD-15-S-12.00-01-ST4](#) [HCSD-17-D-06.00-01-N](#) [HCSD-18-01-T](#) [HCSD-20-D-02.50-01-N-R](#) [HCSD-20-D-06.00-01](#)