

Trench gate field-stop IGBT, M series 650 V, 4 A low loss

Datasheet - production data

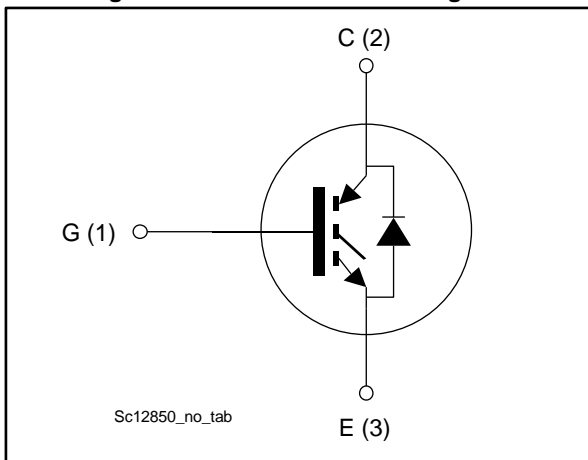

Figure 1: Internal schematic diagram



Features

- 6 μ s of short-circuit withstand time
- $V_{CE(sat)} = 1.6$ V (typ.) @ $I_C = 4$ A
- Tight parameter distribution
- Safer paralleling
- Low thermal resistance
- Soft and very fast recovery antiparallel diode

Applications

- Motor control
- UPS
- PFC

Description

This device is an IGBT developed using an advanced proprietary trench gate field-stop structure. The device is part of the M series IGBTs, which represent an optimal balance between inverter system performance and efficiency where low-loss and short-circuit functionality are essential. Furthermore, the positive $V_{CE(sat)}$ temperature coefficient and tight parameter distribution result in safer paralleling operation.

Table 1: Device summary

Order code	Marking	Package	Packing
STGF4M65DF2	G4M65DF2	TO-220FP	Tube

Contents

1	Electrical ratings	3
2	Electrical characteristics	4
	2.1 Electrical characteristics (curves).....	6
3	Test circuits	11
4	Package information	12
	4.1 TO-220FP package information	13
5	Revision history	15

1 Electrical ratings

Table 2: Absolute maximum ratings

Symbol	Parameter	Value	Unit
V_{CES}	Collector-emitter voltage ($V_{GE} = 0$ V)	650	V
$I_C^{(1)}$	Continuous collector current at $T_C = 25$ °C	8	A
	Continuous collector current at $T_C = 100$ °C	4	A
$I_{CP}^{(2)}$	Pulsed collector current	16	A
V_{GE}	Gate-emitter voltage	±20	V
$I_F^{(1)}$	Continuous forward current at $T_C = 25$ °C	8	A
	Continuous forward current at $T_C = 100$ °C	4	A
$I_{FP}^{(2)}$	Pulsed forward current	16	A
V_{ISO}	Insulation withstand voltage (RMS) from all three leads to external heat sink ($t=1$ s, $T_C= 25$ °C)	2.5	kV
P_{TOT}	Total dissipation at $T_C = 25$ °C	23	W
T_{STG}	Storage temperature range	- 55 to 150	°C
T_J	Operating junction temperature range	- 55 to 175	°C

Notes:

(1)Limited by maximum junction temperature.

(2)Pulse width limited by maximum junction temperature.

Table 3: Thermal data

Symbol	Parameter	Value	Unit
R_{thJC}	Thermal resistance junction-case IGBT	6.5	°C/W
R_{thJC}	Thermal resistance junction-case diode	7	°C/W
R_{thJA}	Thermal resistance junction-ambient	62.5	°C/W

2 Electrical characteristics

$T_C = 25\text{ °C}$ unless otherwise specified

Table 4: Static characteristics

Symbol	Parameter	Test conditions	Min.	Typ.	Max.	Unit
$V_{(BR)CES}$	Collector-emitter breakdown voltage	$V_{GE} = 0\text{ V}$, $I_C = 250\text{ }\mu\text{A}$	650			V
$V_{CE(sat)}$	Collector-emitter saturation voltage	$V_{GE} = 15\text{ V}$, $I_C = 4\text{ A}$		1.6	2.1	V
		$V_{GE} = 15\text{ V}$, $I_C = 4\text{ A}$, $T_J = 125\text{ °C}$		1.9		
		$V_{GE} = 15\text{ V}$, $I_C = 4\text{ A}$, $T_J = 175\text{ °C}$		2.1		
V_F	Forward on-voltage	$I_F = 4\text{ A}$		1.9		V
		$I_F = 4\text{ A}$, $T_J = 125\text{ °C}$		1.7		
		$I_F = 4\text{ A}$, $T_J = 175\text{ °C}$		1.6		
$V_{GE(th)}$	Gate threshold voltage	$V_{CE} = V_{GE}$, $I_C = 250\text{ }\mu\text{A}$	5	6	7	V
I_{CES}	Collector cut-off current	$V_{GE} = 0\text{ V}$, $V_{CE} = 650\text{ V}$			25	μA
I_{GES}	Gate-emitter leakage current	$V_{CE} = 0\text{ V}$, $V_{GE} = \pm 20\text{ V}$			± 250	μA

Table 5: Dynamic characteristics

Symbol	Parameter	Test conditions	Min.	Typ.	Max.	Unit
C_{ies}	Input capacitance	$V_{CE} = 25\text{ V}$, $f = 1\text{ MHz}$, $V_{GE} = 0\text{ V}$	-	369	-	pF
C_{oes}	Output capacitance		-	24.8	-	
C_{res}	Reverse transfer capacitance		-	8	-	
Q_g	Total gate charge	$V_{CC} = 520\text{ V}$, $I_C = 4\text{ A}$, $V_{GE} = 15\text{ V}$ (see Figure 30: "Gate charge test circuit")	-	15.2	-	nC
Q_{ge}	Gate-emitter charge		-	3	-	
Q_{gc}	Gate-collector charge		-	7	-	

Table 6: IGBT switching characteristics (inductive load)

Symbol	Parameter	Test conditions	Min.	Typ.	Max.	Unit
$t_{d(on)}$	Turn-on delay time	$V_{CE} = 400\text{ V}$, $I_C = 4\text{ A}$, $V_{GE} = 15\text{ V}$, $R_G = 47\ \Omega$ (see Figure 29: "Test circuit for inductive load switching")		12	-	ns
t_r	Current rise time			6.9	-	ns
$(di/dt)_{on}$	Turn-on current slope			480	-	A/ μ s
$t_{d(off)}$	Turn-off-delay time			86	-	ns
t_f	Current fall time			120	-	ns
$E_{on(1)}$	Turn-on switching energy			0.040	-	mJ
$E_{off(2)}$	Turn-off switching energy			0.136	-	mJ
E_{ts}	Total switching energy			0.176	-	mJ
$t_{d(on)}$	Turn-on delay time	$V_{CE} = 400\text{ V}$, $I_C = 4\text{ A}$, $V_{GE} = 15\text{ V}$, $R_G = 47\ \Omega$, $T_J = 175\text{ }^\circ\text{C}$ (see Figure 29: "Test circuit for inductive load switching")		11.6	-	ns
t_r	Current rise time			8	-	ns
$(di/dt)_{on}$	Turn-on current slope			410	-	A/ μ s
$t_{d(off)}$	Turn-off-delay time			85	-	ns
t_f	Current fall time			211	-	ns
$E_{on(1)}$	Turn-on switching energy			0.067	-	mJ
$E_{off(2)}$	Turn-off switching energy			0.210	-	mJ
E_{ts}	Total switching energy			0.277	-	mJ
t_{sc}	Short-circuit withstand time	$V_{CC} \leq 400\text{ V}$, $V_{GE} = 15\text{ V}$, $T_{Jstart} = 150\text{ }^\circ\text{C}$	6		-	μ s
		$V_{CC} \leq 400\text{ V}$, $V_{GE} = 13\text{ V}$, $T_{Jstart} = 150\text{ }^\circ\text{C}$	10		-	μ s

Notes:

(1)Including the reverse recovery of the diode.

(2)Including the tail of the collector current.

Table 7: Diode switching characteristics (inductive load)

Symbol	Parameter	Test conditions	Min.	Typ.	Max.	Unit
t_{rr}	Reverse recovery time	$I_F = 4\text{ A}$, $V_R = 400\text{ V}$, $V_{GE} = 15\text{ V}$, $di/dt = 800\text{ A}/\mu\text{s}$ (see Figure 29: "Test circuit for inductive load switching")	-	133	-	ns
Q_{rr}	Reverse recovery charge		-	140	-	nC
I_{rrm}	Reverse recovery current		-	5	-	A
dl_{rr}/dt	Peak rate of fall of reverse recovery current during t_b		-	520	-	A/ μ s
E_{rr}	Reverse recovery energy		-	15	-	μ J
t_{rr}	Reverse recovery time	$I_F = 4\text{ A}$, $V_R = 400\text{ V}$, $V_{GE} = 15\text{ V}$, $T_J = 175\text{ }^\circ\text{C}$, $di/dt = 800\text{ A}/\mu\text{s}$ (see Figure 29: "Test circuit for inductive load switching")	-	236	-	ns
Q_{rr}	Reverse recovery charge		-	370	-	nC
I_{rrm}	Reverse recovery current		-	6.6	-	A
dl_{rr}/dt	Peak rate of fall of reverse recovery current during t_b		-	378	-	A/ μ s
E_{rr}	Reverse recovery energy		-	32	-	μ J

2.1 Electrical characteristics (curves)

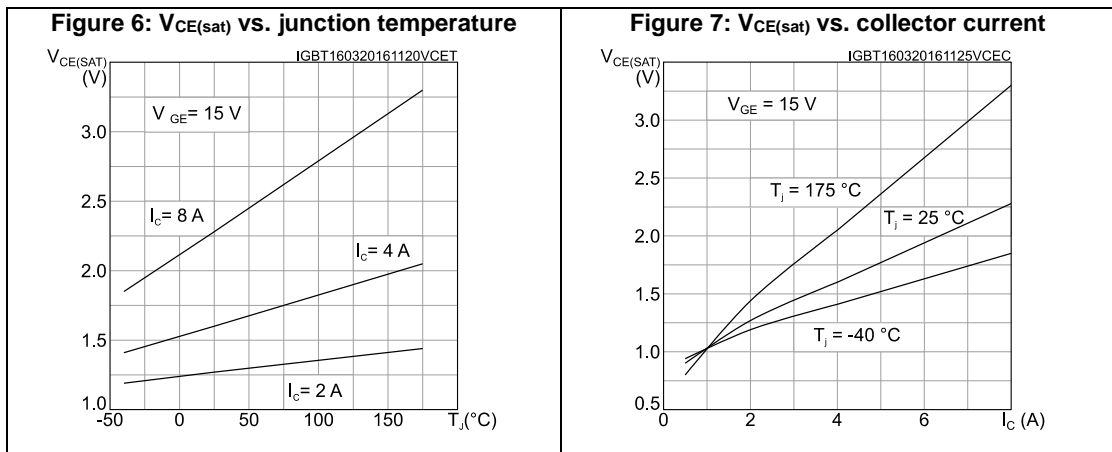
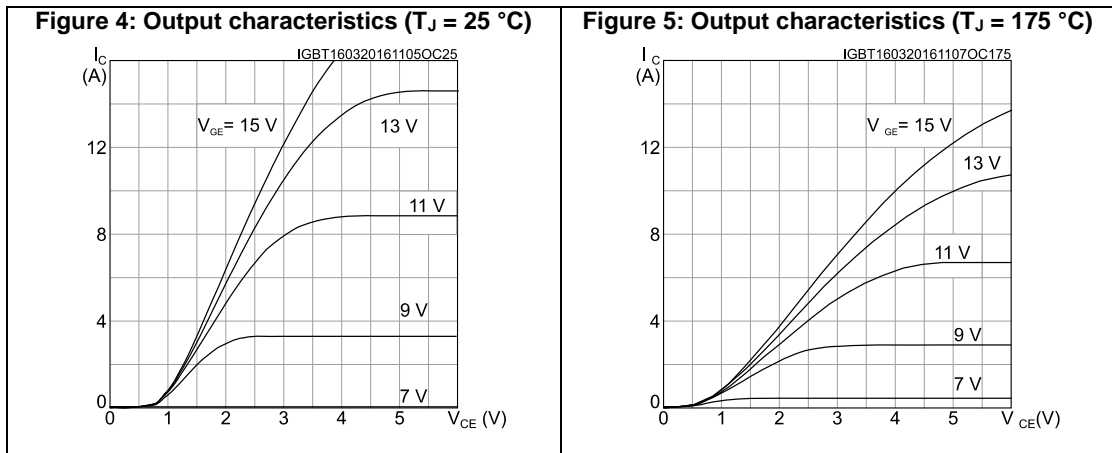
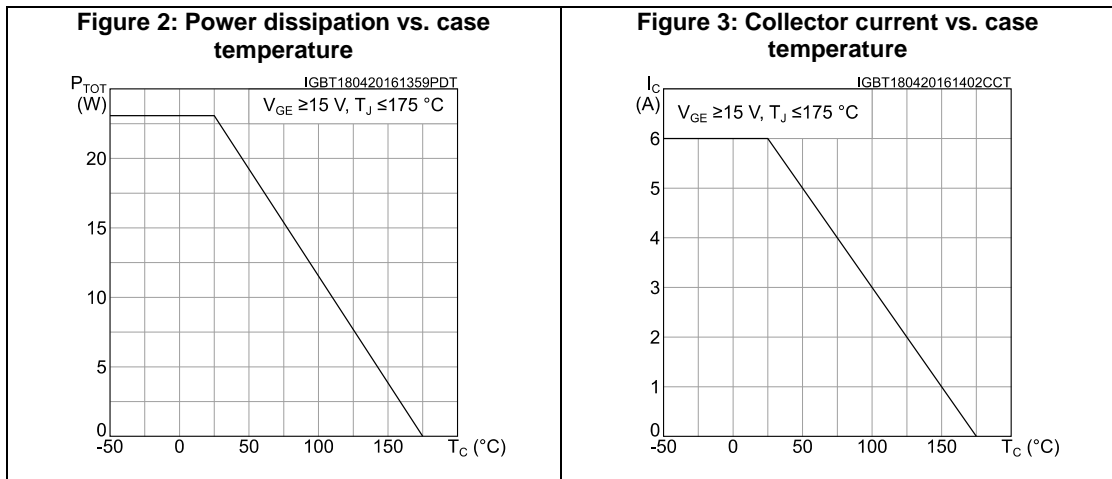

Figure 8: Collector current vs. switching frequency

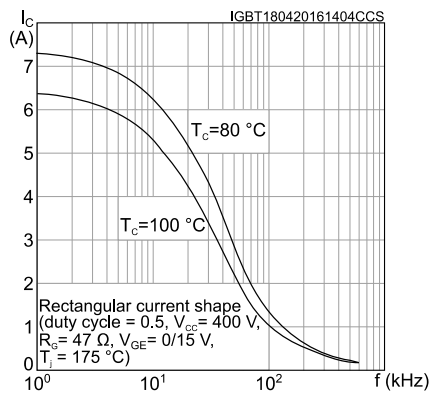

Figure 9: Forward bias safe operating area

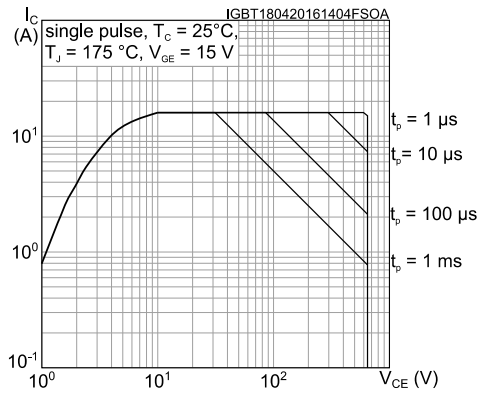

Figure 10: Transfer characteristics

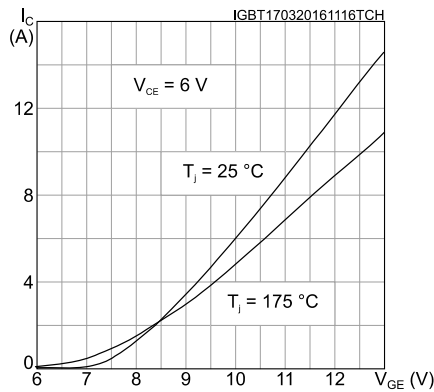

Figure 11: Diode V_F vs. forward current

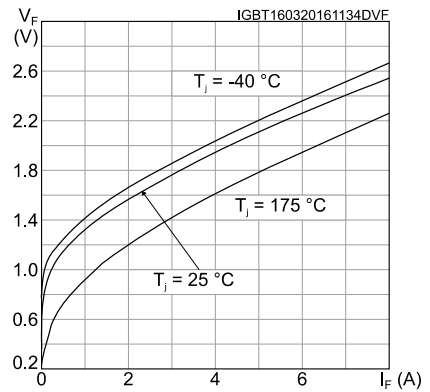

Figure 12: Normalized V_GE(th) vs. junction temperature

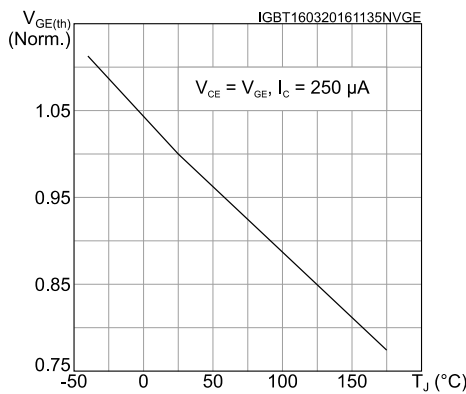
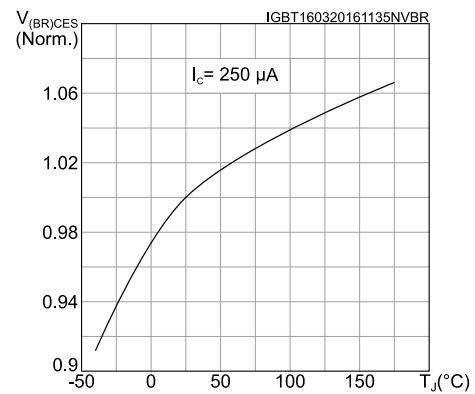

Figure 13: Normalized V_(BR)CES vs. junction temperature



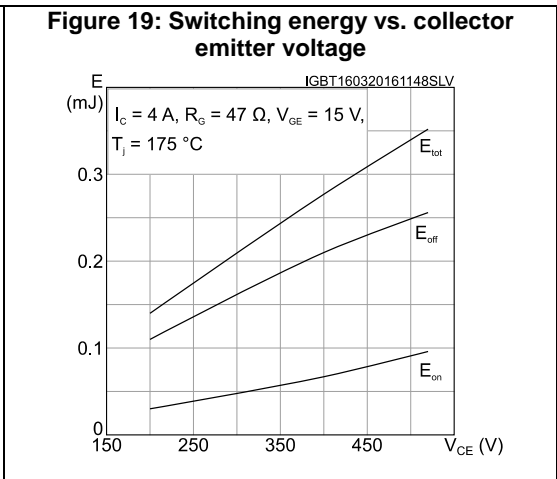
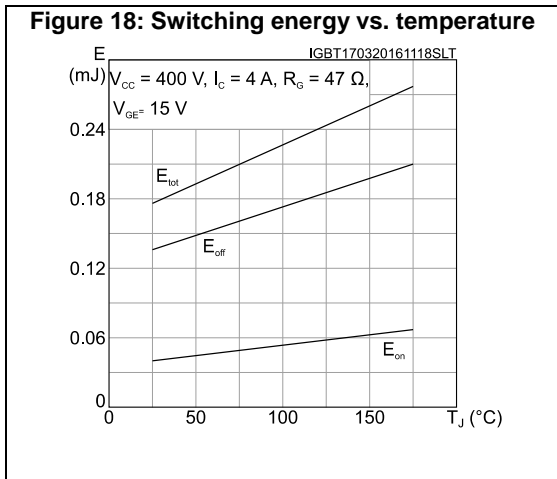
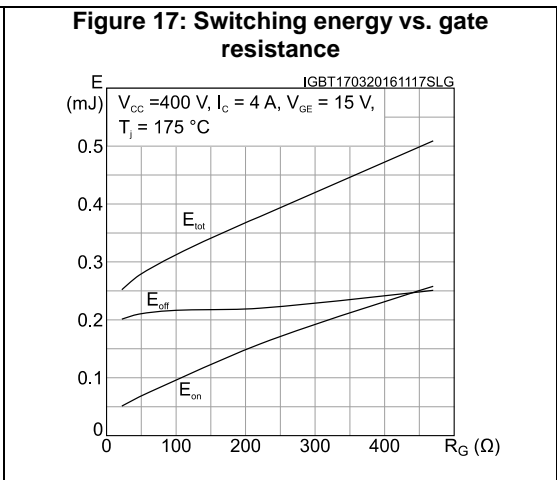
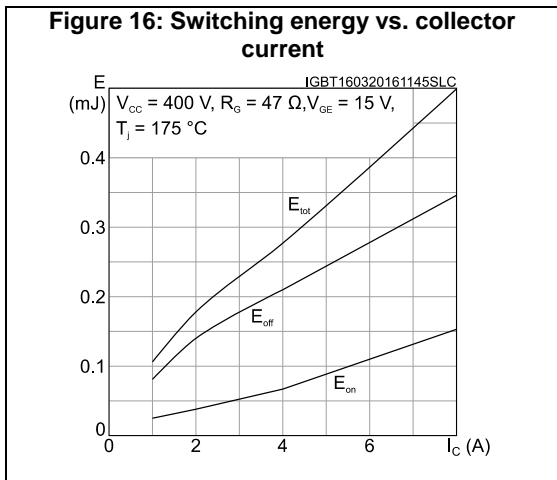
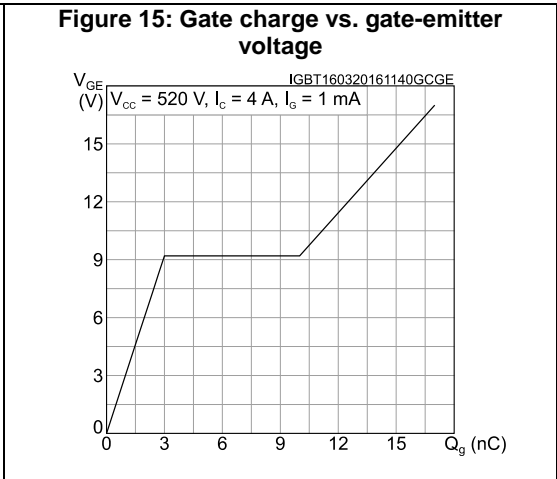
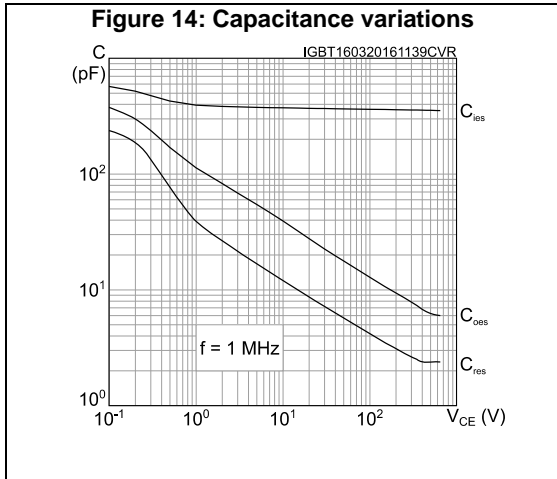

Figure 20: Short-circuit time and current vs. V_{GE}

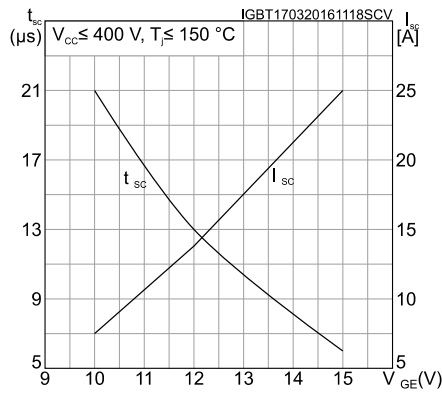

Figure 21: Switching times vs. collector current

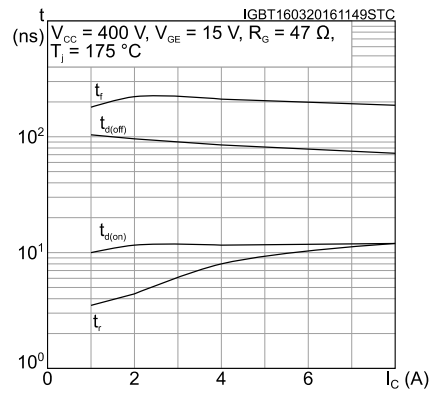

Figure 22: Switching times vs. gate resistance

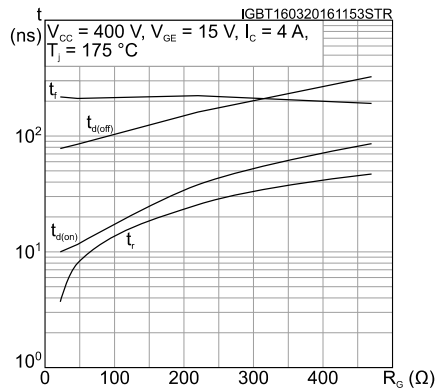

Figure 23: Reverse recovery current vs. diode current slope

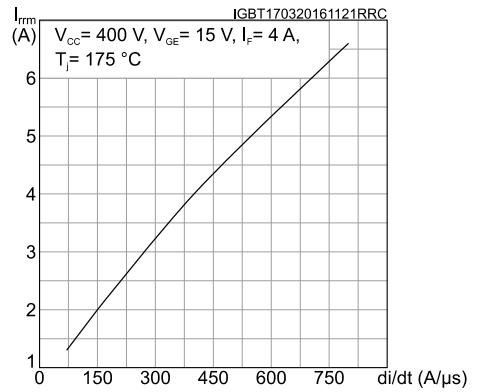

Figure 24: Reverse recovery time vs. diode current slope

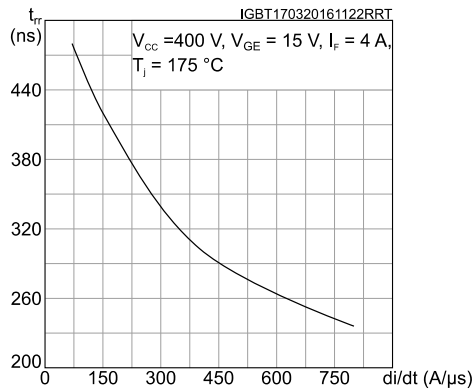

Figure 25: Reverse recovery charge vs. diode current slope

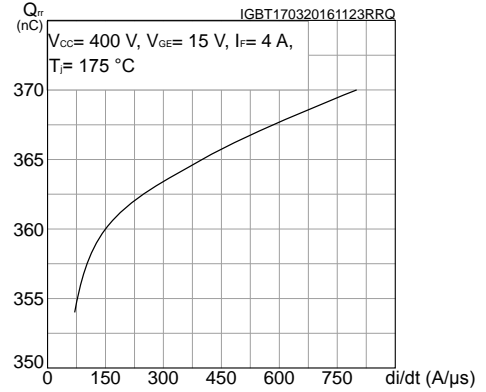

Figure 26: Reverse recovery energy vs. diode current slope

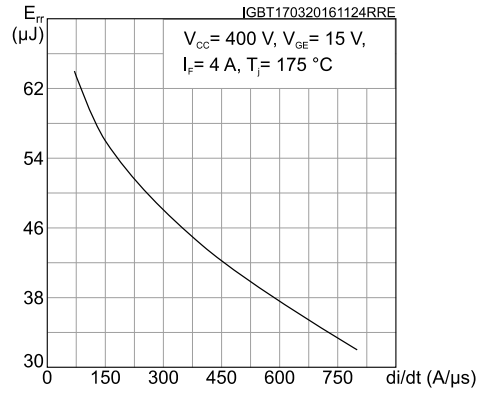

Figure 27: Thermal impedance for IGBT

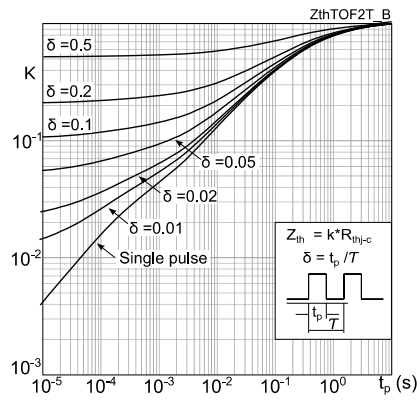
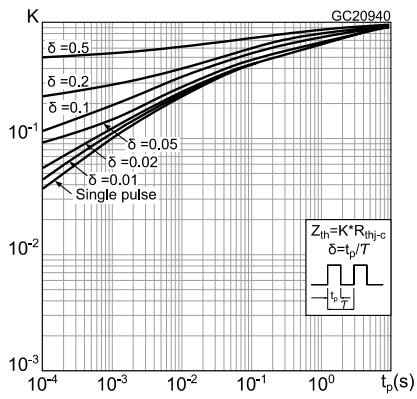
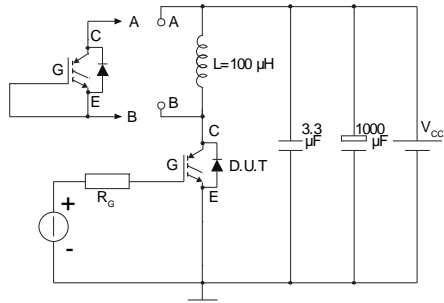

Figure 28: Thermal impedance for diode



3 Test circuits

Figure 29: Test circuit for inductive load switching



AM01504v1

Figure 30: Gate charge test circuit

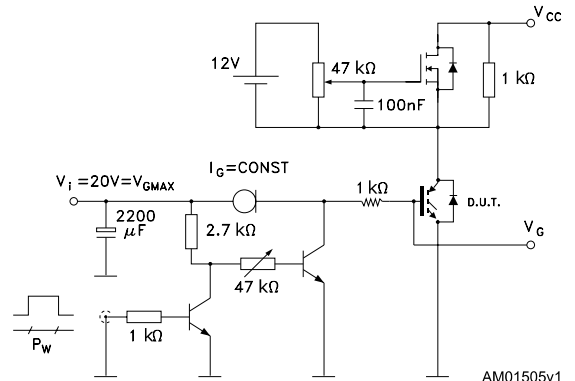

AM01505v1

Figure 31: Switching waveform

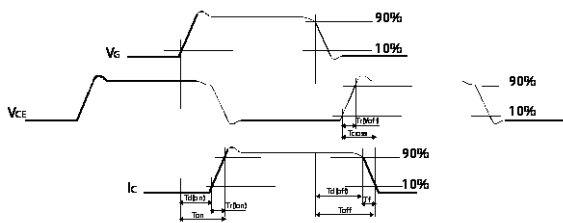

AM01506v1

Figure 32: Diode reverse recovery waveform

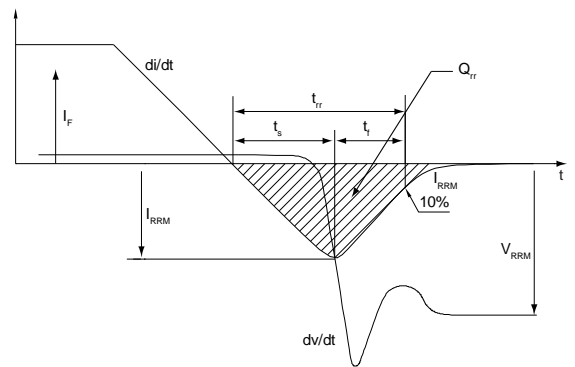

AM01507v1

4 Package information

In order to meet environmental requirements, ST offers these devices in different grades of ECOPACK® packages, depending on their level of environmental compliance. ECOPACK® specifications, grade definitions and product status are available at: www.st.com. ECOPACK® is an ST trademark.

4.1 TO-220FP package information

Figure 33: TO-220FP package outline

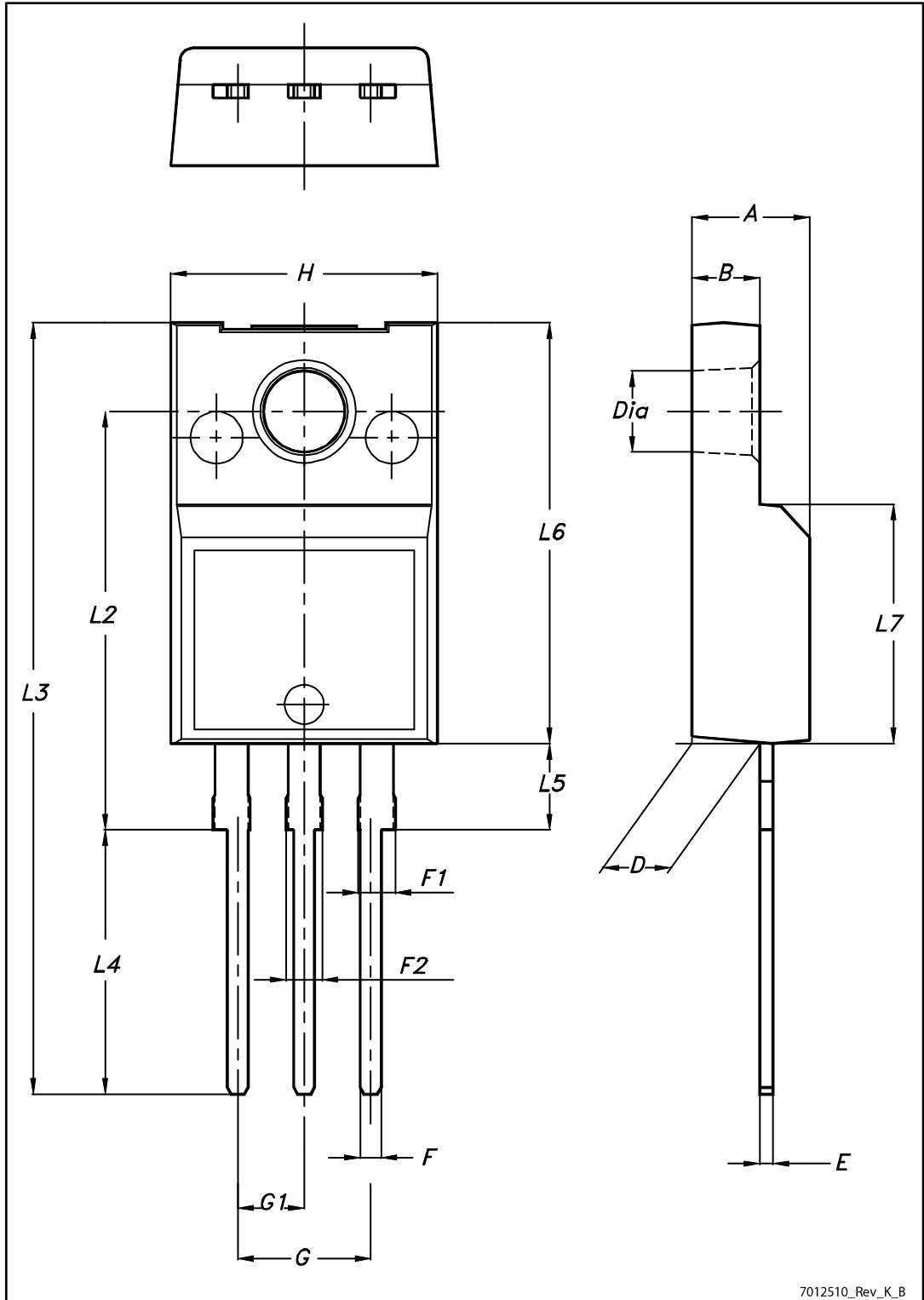

7012510_Rev_K_B

Table 8: TO-220FP package mechanical data

Dim.	mm		
	Min.	Typ.	Max.
A	4.4		4.6
B	2.5		2.7
D	2.5		2.75
E	0.45		0.7
F	0.75		1
F1	1.15		1.70
F2	1.15		1.70
G	4.95		5.2
G1	2.4		2.7
H	10		10.4
L2		16	
L3	28.6		30.6
L4	9.8		10.6
L5	2.9		3.6
L6	15.9		16.4
L7	9		9.3
Dia	3		3.2

5 Revision history

Table 9: Document revision history

Date	Revision	Changes
25-Nov-2015	1	First release.
18-Apr-2016	2	Modified: features in cover page. Modified: <i>Table 2: "Absolute maximum ratings"</i> , <i>Table 3: "Thermal data"</i> , <i>Table 4: "Static characteristics"</i> , <i>Table 5: "Dynamic characteristics"</i> , <i>Table 6: "IGBT switching characteristics (inductive load)"</i> and <i>Table 7: "Diode switching characteristics (inductive load)"</i> Added: <i>Section 2.1: "Electrical characteristics (curves)"</i> . Minor text changes
13-Jul-2016	3	Document status promoted from preliminary to production data.
21-Nov-2016	4	Updated <i>Figure 1: "Internal schematic diagram"</i> Updated <i>Table 2: "Absolute maximum ratings"</i> Updated <i>Figure 25: "Reverse recovery charge vs. diode current slope"</i> Minor text changes

IMPORTANT NOTICE – PLEASE READ CAREFULLY

STMicroelectronics NV and its subsidiaries ("ST") reserve the right to make changes, corrections, enhancements, modifications, and improvements to ST products and/or to this document at any time without notice. Purchasers should obtain the latest relevant information on ST products before placing orders. ST products are sold pursuant to ST's terms and conditions of sale in place at the time of order acknowledgement.

Purchasers are solely responsible for the choice, selection, and use of ST products and ST assumes no liability for application assistance or the design of Purchasers' products.

No license, express or implied, to any intellectual property right is granted by ST herein.

Resale of ST products with provisions different from the information set forth herein shall void any warranty granted by ST for such product.

ST and the ST logo are trademarks of ST. All other product or service names are the property of their respective owners.

Information in this document supersedes and replaces information previously supplied in any prior versions of this document.

© 2016 STMicroelectronics – All rights reserved

Mouser Electronics

Authorized Distributor

Click to View Pricing, Inventory, Delivery & Lifecycle Information:

[STMicroelectronics:](#)

[STGF4M65DF2](#)