

977 Series, 5×20mm, Time-Lag Fuse



Description

450Vdc/500Vac rated, 5×20mm, Time-Lag, surge withstand, ceramic body, cartridge fuse.



Features

- Designed to International (IEC) Standards for use globally
- Follow the IEC 60127-2, Sheet 5 specification for Time-Lag Fuses
- Available in Cartridge and Axial lead Form
- Rohs compliant and Pb-free

Applications

Inverter in LCD backlight unit, DC side of air-conditioners, 3-phase power supplies, Higher Energy and Power Efficient applications.

Agency Approvals

Agency	Agency File Number	Ampere Range
	Cartridge: NBK040609-JP1021A	2A – 5A
	NBK040609-JP1021C	6.3A – 12A
	NBK100408-JP1021A	16A
	Leaded: NBK040609-JP1021B	2A – 5A
	NBK040609-JP1021D	6.3A – 12A
	NBK100408-JP1021B	16A
	1410854	0.5A-8A
	N/A	0.5A-8A

Electrical Characteristics for Series

% of Ampere Rating	Ampere Rating	Opening Time
150%	0.5A – 8A	60 minutes, Minimum
	2A – 3.15A	60 minutes, Minimum
	4A – 6.3A	60 minutes, Minimum
	8A – 16A	30 minutes, Minimum
210%	0.5A – 8A	30 minutes, Maximum
	2A – 3.15A	30 minutes, Maximum
	4A – 6.3A	30 minutes, Maximum
	8A – 16A	30 minutes, Maximum
275%	0.5A – 8A	250 ms. Min.; 80 secs. Max.
	2A – 3.15A	750 ms. Min.; 80 secs. Max.
	4A – 6.3A	750 ms. Min.; 80 secs. Max.
	8A – 16A	750 ms. Min.; 80 secs. Max.
400%	0.5A – 8A	50 ms, Min.; 5 secs. Max.
	2A – 3.15A	95 ms, Min.; 5 secs. Max.
	4A – 6.3A	150 ms, Min.; 5 secs. Max.
	8A – 16A	150 ms, Min.; 5 secs. Max.
1000%	0.5A – 8A	5 ms, Min.; .150 ms, Max.
	2A – 3.15A	10 ms, Min.; .150 ms, Max.
	4A – 6.3A	10 ms, Min.; .150 ms, Max.
	8A – 16A	10 ms, Min.; .150 ms, Max.

Additional Information



Datasheet



Resources



Samples

Electrical Characteristic

Amp Code	Amp Rating	Voltage Rating		Interrupting Rating	Nominal Cold Resistance (milli-ohms)	Nominal Melting I ² t (A ² sec.)	Agency Approvals	
		AC	DC				PS E	S
.500	0.5	500	450	100A @ 500Vac 200A @ 450Vdc	945.0	0.3		x
.800	0.8	500	450		417.0	0.8		x
002.	2	500	450		44.5	17	x	x
3.15	3.15	500	450		27.5	58	x	x
004.	4	500	450		18.4	124	x	x
005.	5	500	450		11.9	91	x	x
06.3	6.3	500	450		9.1	188	x	x
008.	8	500	450		8.0	233	x	x
010.	10	500	450		7.2	249	x	
012.	12	500	450		5.8	388	x	
016.	16	500	450		3.9	725	x	

I²t test at 10x rated current.

Temperature Re-rating Curve

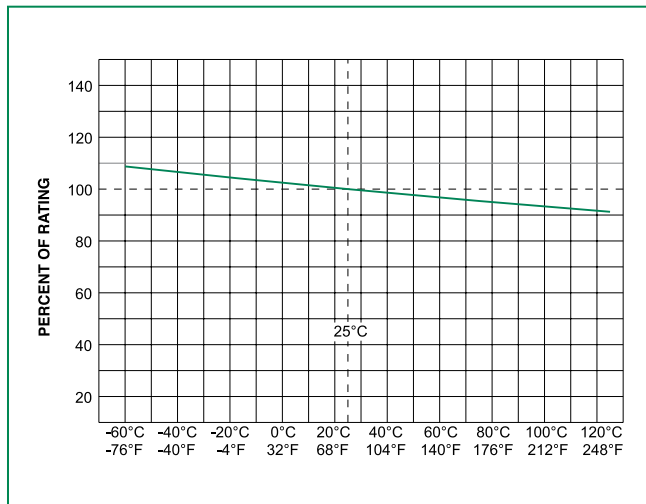

Average Time Current Curves

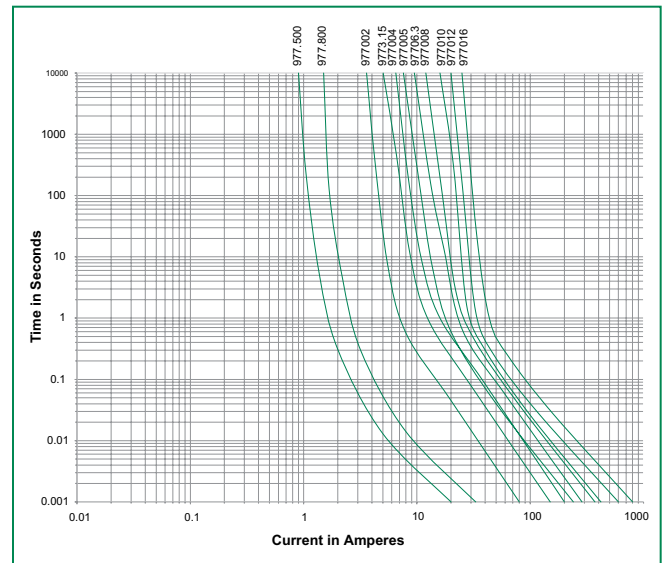

Soldering Parameters - Wave Soldering

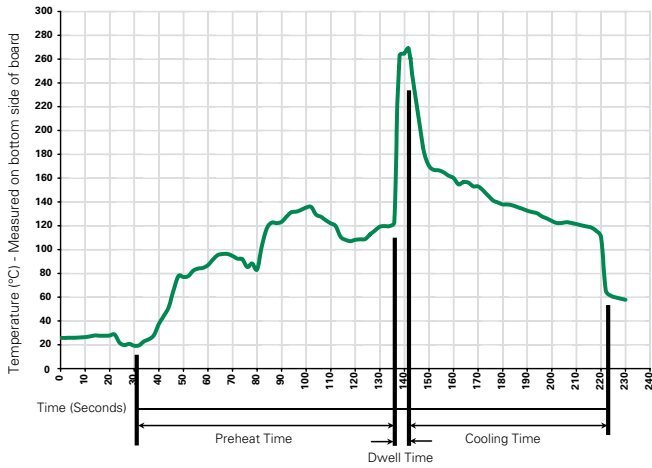

Recommended Process Parameters:

Wave Parameter	Lead-Free Recommendation
Preheat: (Depends on Flux Activation Temperature) (Typical Industry Recommendation)	
Temperature Minimum:	100°C
Temperature Maximum:	150°C
Preheat Time:	60-180 seconds
Solder Pot Temperature:	260°C Maximum
Solder Dwell Time:	2-5 seconds

Recommended Hand-Solder Parameters:

Solder Iron Temperature: 350°C +/- 5°C
 Heating Time: 5 seconds max.

Note: These devices are not recommended for IR or Convection Reflow process.

Product Characteristics

Materials	Body: Ceramic Cap: Nickel-plated Brass Leads: Tin-plated Copper
Terminal Strength	MIL-STD-202, Method 211, Test Condition A
Solderability	MIL-STD-202 Method 208
Product Marking	Cap 1: Brand logo, current and voltage ratings Cap 2: Series and agency approval markings

Operating Temperature	-55°C to +125°C
Thermal Shock	MIL-STD-202, Method 107, Test Condition B (5 cycles, -65°C to +125°C)
Vibration	MIL-STD-202, Method 201
Humidity	MIL-STD-202, Method 103, Test Condition A (High RH (95%) and elevated temp (40°C) for 240 hours)
Salt Spray	MIL-STD-202, Method 101, Test Condition B

Axial Lead & Cartridge Fuses

5x20mm > Time-Lag > 977 Series

Dimensions

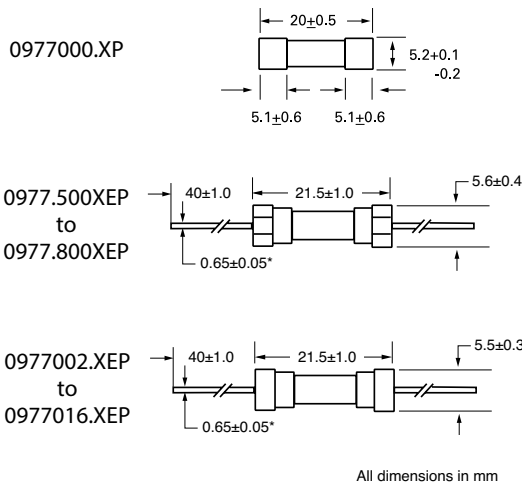

Notes:
 * Ratings above 5A 1.0±0.05 diameter lead.
 * For 977 16A 1.2±0.05 diameter lead.

Part Numbering System

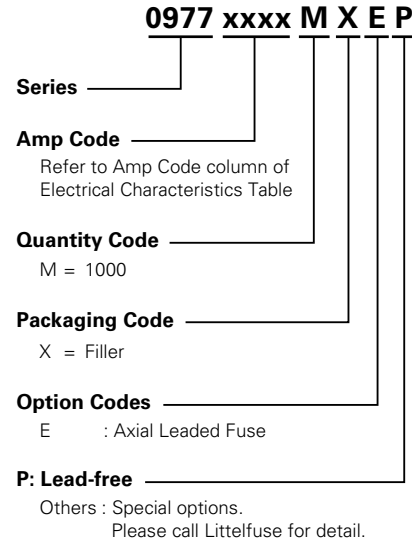

Packaging

Packaging Option	Packaging Specification	Quantity	Quantity & Packaging Code	Reel Size
977 Series				
Bulk	N/A	1000	MX	N/A
Bulk	N/A	1000	MXE	N/A

Disclaimer Notice - Information furnished is believed to be accurate and reliable. However, users should independently evaluate the suitability of and test each product selected for their own applications. Littelfuse products are not designed for, and may not be used in, all applications. Read complete Disclaimer Notice at www.littelfuse.com/disclaimer-electronics.

Mouser Electronics

Authorized Distributor

Click to View Pricing, Inventory, Delivery & Lifecycle Information:

Littelfuse:

[0977.500MXEP](#) [0977.500MXP](#) [0977.800MXEP](#) [0977.800MXP](#) [0977002.MXEP](#) [0977002.MXP](#) [0977004.MXEP](#)
[0977004.MXP](#) [0977005.MXEP](#) [0977005.MXP](#) [0977008.MXEP](#) [0977008.MXP](#) [0977010.MXEP](#) [0977010.MXP](#)
[0977012.MXEP](#) [0977012.MXP](#) [0977016.MXEP](#) [0977016.MXP](#) [097706.3MXEP](#) [097706.3MXP](#) [09773.15MXEP](#)
[09773.15MXP](#)