

# Reference Only

Spec.No.JENF243A-0038K-01

P1/10

## Chip Ferrite Bead BLM02□X□□□SN1□ Reference Specification

### 1.Scope

This reference specification applies to Chip Ferrite Bead BLM02□X\_SN Series.

### 2.Part Numbering

(ex.) 

BL	M	02	AX	121	S	N	1	D
(1)	(2)	(3)	(4)	(5)	(6)	(7)	(8)	(9)

(1)Product ID (2)Type (3)Dimension(L×W) (4)Characteristics (5)Typical Impedance at 100MHz  
(6)Performance (7)Category (8)Numbers of Circuit (9)Packaging

D:Paper Tape

\*B:Bulk

\*Bulk packing also available. (A product is put in the plastic bag under the taping conditions.)

### 3.Rating

Customer Part Number	MURATA Part Number	Impedance (Ω) (at 100MHz, Under Standard Testing Condition)	Rated Current(mA)		DC Resistance (Ω max.)		Remark
			at 85°C	at 125°C	Initial Values	Values After Testing	
	BLM02AX100SN1D	10±5Ω	750		0.07	0.12	For general use
	BLM02AX700SN1D	70±25%	300		0.36	0.46	
	BLM02AX121SN1D	120±25%	250		0.5	0.6	
	BLM02AX241SN1D	240±25%	200		0.9	1.0	
	BLM02AX331SN1D	330±25%	150		1.4	1.5	
	BLM02BX121SN1D	120±25%	350* <sup>1</sup>	240* <sup>1</sup>	0.5	0.6	For high speed signal line
	BLM02BX151SN1D	150±25%	280* <sup>1</sup>	200* <sup>1</sup>	0.7	0.8	
	BLM02BX241SN1D	240±25%	240* <sup>1</sup>	160* <sup>1</sup>	1.1	1.2	
	BLM02PX100SN1D	5 to15	1100* <sup>1</sup>	850* <sup>1</sup>	0.05	0.10	For DC power line
	BLM02PX220SN1D	22±25%	750* <sup>1</sup>	550* <sup>1</sup>	0.11	0.16	
	BLM02PX330SN1D	33±25%	550* <sup>1</sup>	400* <sup>1</sup>	0.20	0.25	
	BLM02PX600SN1D	60±25%	500* <sup>1</sup>	350* <sup>1</sup>	0.25	0.30	
	BLM02KX100SN1D	10±5Ω	1500* <sup>1</sup>	1250* <sup>1</sup>	0.03	0.08	
	BLM02KX180SN1D	18±25%	1200* <sup>1</sup>	950* <sup>1</sup>	0.045	0.095	

■ Operating Temperature : -55°C to +125°C

■ Storage Temperature : -55°C to +125°C

(Note) As for the Rated current marked with \*<sup>1</sup>,  
Rated Current is derated as right figure  
depending on the operating temperature.

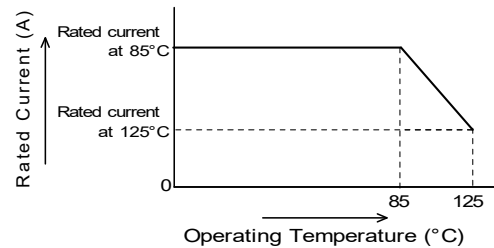

# Reference Only

Spec.No.JENF243A-0038K-01

P2/10

## 4.Style and Dimensions

Except for BLM02KX

BLM02KX

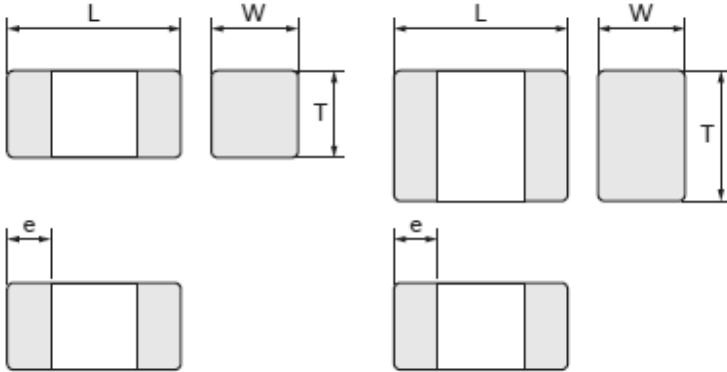

L	0.40±0.02
W	0.20±0.02
T	0.20±0.02
e	0.10 <sup>+0.04</sup> <sub>-0.03</sub>

L	0.40±0.02
W	0.20±0.02
T	0.30±0.02
e	0.10 <sup>+0.04</sup> <sub>-0.03</sub>

(in mm)

### ■ Equivalent Circuit



( Resistance element becomes dominant at high frequencies. )

### ■ Unit Mass (Typical value)

BLM02KX	: 0.095mg
Except for BLM02KX	: 0.08mg

## 5.Marking

No marking.

## 6.Standard Testing Conditions

< Unless otherwise specified >

Temperature : Ordinary Temp. (15 °C to 35 °C)

Humidity : Ordinary Humidity (25%(RH) to 85%(RH))

< In case of doubt >

Temperature : 20°C±2 °C

Humidity : 60%(RH) to 70%(RH)

Atmospheric pressure : 86kPa to 106kPa

## 7.Specifications

### 7-1.Electrical Performance

No.	Item	Specification	Test Method
7-1-1	Impedance	Meet item 3.	Measuring Frequency : 100MHz±1MHz Measuring Equipment : KEYSIGHT4291A or the equivalent Test Fixture : KEYSIGHT16197A or the equivalent
7-1-2	DC Resistance	Meet item 3.	Measuring Equipment : Digital multi meter * Except resistance of the Substrate and Wire

### 7-2.Mechanical Performance

No.	Item	Specification	Test Method						
7-2-1	Appearance and Dimensions	Meet item 4.	Visual Inspection and measured with Measuring Microscope.						
7-2-2	Bending Strength	Meet Table 1.  <table border="1" style="margin-left: 20px;"> <caption>Table 1</caption> <tr><td>Appearance</td><td>No damage</td></tr> <tr><td>Impedance Change (at 100MHz)</td><td>Within ±30%</td></tr> <tr><td>DC Resistance</td><td>Meet item 3.</td></tr> </table>	Appearance	No damage	Impedance Change (at 100MHz)	Within ±30%	DC Resistance	Meet item 3.	It shall be soldered on the Glass-epoxy substrate. Substrate : 100mm×40mm×0.8mm Deflection : 1.0mm Speed of Applying Force : 0.5mm/s Keeping Time : 30s  
Appearance	No damage								
Impedance Change (at 100MHz)	Within ±30%								
DC Resistance	Meet item 3.								

# Reference Only

Spec.No.JENF243A-0038K-01

P3/10

No.	Item	Specification	Test Method
7-2-3	Vibration	Meet Table 1.	It shall be soldered on the substrate. Oscillation Frequency : 10Hz to 2000Hz to 10Hz for 20 min Amplitude : Total Amplitude 1.5mm or Acceleration amplitude 196m/s <sup>2</sup> whichever is smaller. Testing Time : A period of 2 hours in each of 3 mutually perpendicular directions. (Total 6 h)
7-2-4	Resistance to Soldering Heat (Reflow)		Pre-Heating : 150°C~180°C, 90s±30s Solder : Sn-3.0Ag-0.5Cu Heating:above 230°C,60s Peak temperture:260°C,10s Cycle of reflow:2 times Then measured after exposure in the room condition for 48h±4h.
7-2-5	Solderability	The electrodes shall be at least 95% covered with new solder coating.	Flux : Ethanol solution of rosin,25(wt)% Pre-Heating : 150°C±10°C, 60s~90s Solder : Sn-3.0Ag-0.5Cu Solder Temperature : 240°C±5°C Immersion Time : 3s±1s Immersion and emersion rates : 25mm/s

### 7-3.Environmental Performance

It shall be soldered on the substrate.

No.	Item	Specification	Test Method
7-3-1	Temperature Cycle	Meet Table 1.	1 cycle : 1 step : -55 °C(+0 °C,-3 °C) / 30min±3min 2 step : Ordinary temp. / 10min to 15min 3 step : +125 °C(+3 °C,-0 °C) / 30min±3min 4 step : Ordinary temp. / 10min to 15min Total of 100 cycles Then measured after exposure in the room condition for 48h±4h.
7-3-2	Humidity		Temperature : 70°C±2°C Humidity : 90%(RH) to 95%(RH) Time : 1000h(+48h,-0h) Then measured after exposure in the room condition for 48h±4h.
7-3-3	Heat Life		Temperature : 125°C±3°C Applying Current : Rated Current Time : 1000h(+48h,-0h) Then measured after exposure in the room condition for 48h±4h.
7-3-4	Cold Resistance		Temperature : -55±2°C Time : 1000h(+48h,-0h) Then measured after exposure in the room condition for 48h±4h.

## 8.Specification of Packaging

### 8-1.Appearance and Dimensions (8mm-wide / paper tape)

【8mm-wide paper tape : Except for BLM02KX】

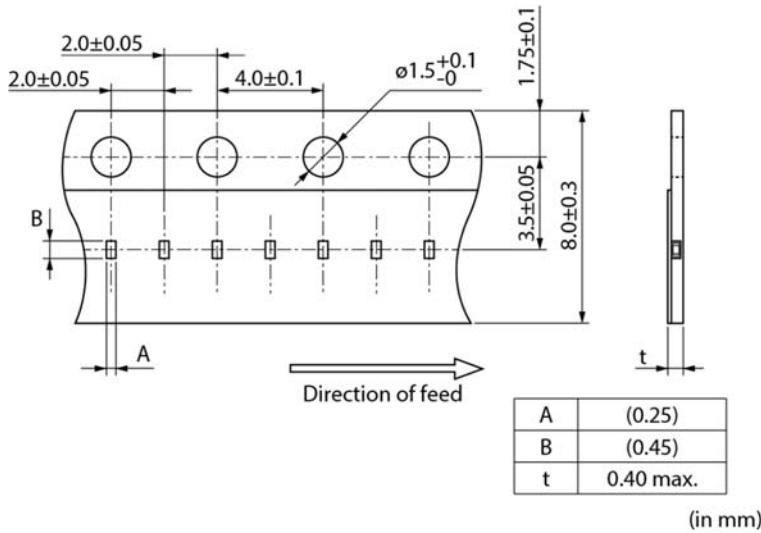

【8mm-wide paper tape : BLM02KX】

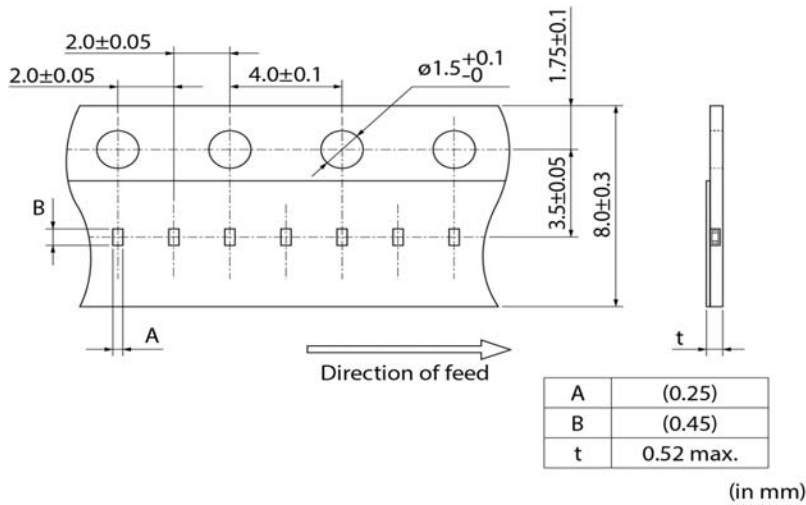

(1) Taping

Products shall be packaged in the each embossed cavity of 8mm-wide, 2mm-pitch continuously and sealed by cover tape.

(2) Sprocket hole : The sprocket holes are to the right as the tape is pulled toward the user.

(3) Spliced point : The cover tape has no spliced point.

(4) Cavity: There shall not be burr in the cavity.

(5) Missing components number

Missing components number within 0.025% of the number per reel or 1 pc., whichever is greater, and are not continuous. The specified quantity per reel is kept.



# Reference Only

Spec.No.JENF243A-0038K-01

P6/10

## 8-4. Specification of Outer Case

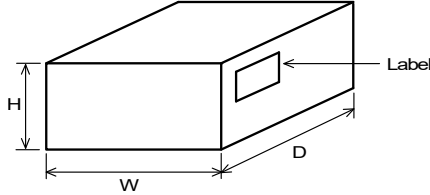

Outer Case Dimensions (mm)			Standard Reel Quantity in Outer Case (Reel)
W	D	H	
186	186	93	5

\* Above Outer Case size is typical. It depends on a quantity of an order.

## 9. Caution

### 9-1. Surge current

Excessive surge current (pulse current or rush current) than specified rated current applied to the product may cause a critical failure, such as an open circuit, burnout caused by excessive temperature rise.

Please contact us in advance in case of applying the surge current.

### 9-2. Limitation of Applications

Please contact us before using our products for the applications listed below which require especially high reliability for the prevention of defects which might directly cause damage to the third party's life, body or property.

- |                                   |  |
|-----------------------------------|--|
| (1) Aircraft equipment            | (6) Disaster prevention / crime prevention equipment   |
| (2) Aerospace equipment           | (7) Traffic signal equipment   |
| (3) Undersea equipment            | (8) Transportation equipment (vehicles, trains, ships, etc.)   |
| (4) Power plant control equipment | (9) Data-processing equipment  |
| (5) Medical equipment             | (10) Applications of similar complexity and /or reliability requirements to the applications listed in the above |

## 10. Notice

Products can only be soldered with reflow.

This product is designed for solder mounting.

Please consult us in advance for applying other mounting method such as conductive adhesive.

### 10-1.Land pattern designing

- Standard land dimensions (Reflow soldering)  
<For BLM02 series (except BLM02PX type)>

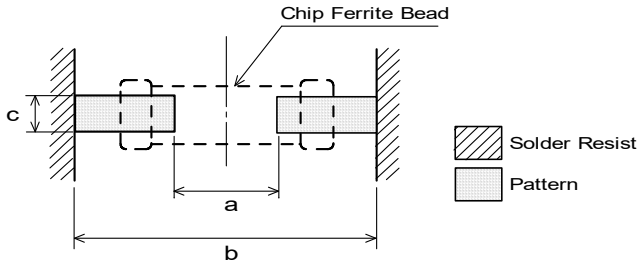

a	b	c
0.18	0.48	0.215

(in mm)

<For BLM02PX type>

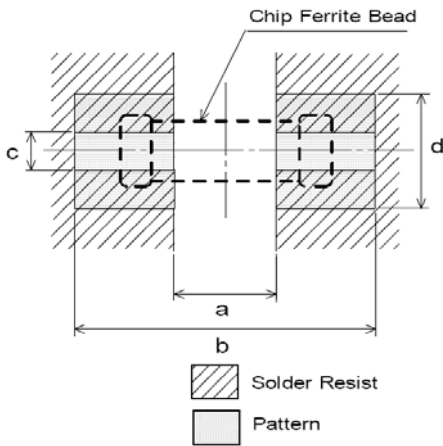

Rated Current (A)	a	b	c	Land pad thickness and dimension d		
				18μm	35μm	70μm
max.1.1	0.18	0.48	0.215	0.23	0.23	0.23

(in mm)

\*The excessive heat by land pads may cause deterioration at joint of products with substrate

### 10-2. Mounting Conditions

- Please check the mounting condition before using.
- Using mounting conditions (nozzles, equipment conditions, etc.) that are not suitable for products may lead to pick up errors, misalignment, or damage to the product.

### 10-3.Soldering Conditions

(1) Flux,Solder

Flux	Use rosin-based flux, but not highly acidic flux (with chlorine content exceeding 0.2(wt)%.) Do not use water-soluble flux.
Solder	Use Sn-3.0Ag-0.5Cu solder Standard thickness of solder paste : 50 μm to 80 μm

(2) Soldering conditions

- Pre-heating should be in such a way that the temperature difference between solder and ferrite surface is limited to 150°C max. Also cooling into solvent after soldering should be in such a way that the temperature difference is limited to 100°C max.  
Insufficient pre-heating may cause cracks on the ferrite, resulting in the deterioration of product quality.
- Standard soldering profile and the limit soldering profile is as follows.  
The excessive limit soldering conditions may cause leaching of the electrode and / or resulting in the deterioration of product quality.

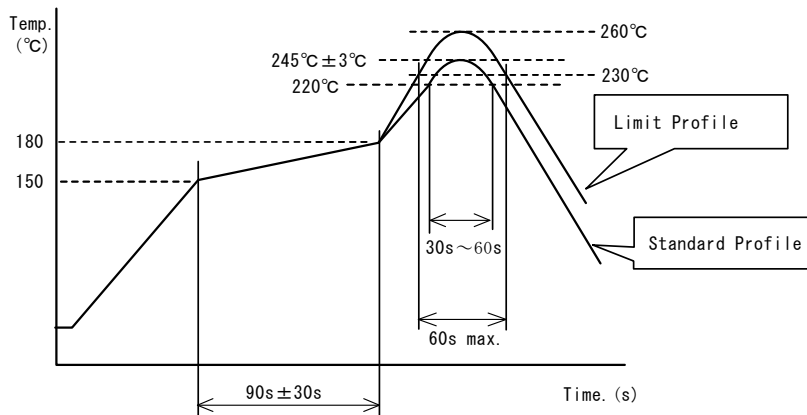

	Standard Profile	Limit Profile
Pre-heating	150~180°C、90s±30s	
Heating	above 220°C、30s~60s	above 230°C、60s max.
Peak temperature	245±3°C	260°C,10s
Cycle of reflow	2 times	2 times

**10-4.Solder Volume**

Solder shall be used not to be exceed as shown below.

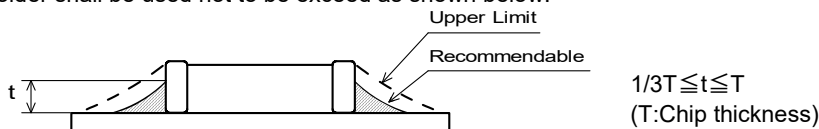

Accordingly increasing the solder volume, the mechanical stress to product is also increased. Exceeding solder volume may cause the failure of mechanical or electrical performance.

**10-5.Attention regarding P.C.B. bending**

The following shall be considered when designing and laying out P.C.B.'s.

- (1) P.C.B. shall be designed so that products are not subject to the mechanical stress for board warpage.  
<Products direction>

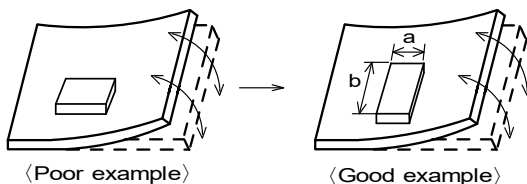

Products shall be located in the sideways direction (Length:a<b) to the mechanical stress.



(2) Components location on P.C.B. separation.

It is effective to implement the following measures, to reduce stress in separating the board.

It is best to implement all of the following three measures; however, implement as many measures as possible to reduce stress.

Contents of Measures	Stress Level
(1) Turn the mounting direction of the component parallel to the board separation surface.	A > D *1
(2) Add slits in the board separation part.	A > B
(3) Keep the mounting position of the component away from the board separation surface.	A > C

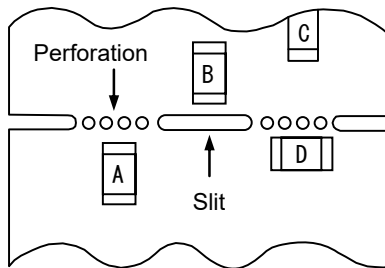

\*1 A > D is valid when stress is added vertically to the perforation as with Hand Separation. If a Cutting Disc is used, stress will be diagonal to the PCB, therefore A > D is invalid.

(3) Mounting Components Near Screw Holes

When a component is mounted near a screw hole, it may be affected by the board deflection that occurs during the tightening of the screw. Mount the component in a position as far away from the screw holes as possible.

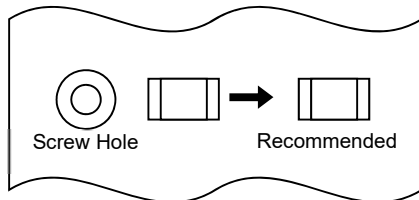

### 10-6. Mounting density

Add special attention to radiating heat of products when mounting the inductor near the products with heating. The excessive heat by other products may cause deterioration at joint of this product with substrate.

### 10-7. Cleaning Conditions

Products shall be cleaned on the following conditions.

- (1) Cleaning temperature shall be limited to 60°C max. (40°C max. for IPA.)
- (2) Ultrasonic cleaning shall comply with the following conditions, avoiding the resonance phenomenon at the mounted products and P.C.B.  
Power: 20W/l max. Frequency: 28kHz to 40kHz Time: 5 min max.
- (3) Cleaner
  1. Alternative cleaner
    - Isopropyl alcohol (IPA)
  2. Aqueous agent
    - PINE ALPHA ST-100S
- (4) There shall be no residual flux and residual cleaner after cleaning.  
In the case of using aqueous agent, products shall be dried completely after rinse with de-ionized water in order to remove the cleaner.
- (5) Other cleaning  
Please contact us.

## 10-8. Operating Environment

Do not use this product under the following environmental conditions, on deterioration of the Insulation Resistance of the Ferrite material and/or corrosion of Inner Electrode may result from the use.

- (1) in the corrodible atmosphere such as acidic gases, alkaline gases, chlorine, sulfur gases, organic gases and etc.  
(the sea breeze, Cl<sub>2</sub>, H<sub>2</sub>S, NH<sub>3</sub>, SO<sub>2</sub>, NO<sub>2</sub>, etc)
- (2) in the atmosphere where liquid such as organic solvent, may splash on the products.
- (3) in the atmosphere where the temperature / humidity changes rapidly and it is easy to dew.

## 10-9. Resin coating

When products are coated with resin, please contact us in advance.

## 10-10. Handling of a substrate

After mounting products on a substrate, do not apply any stress to the product caused by bending or twisting to the substrate when cropping the substrate, inserting and removing a connector from the substrate or tightening screw to the substrate.

Excessive mechanical stress may cause cracking in the product.

Bending

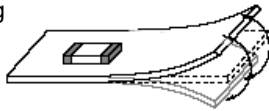

Twisting

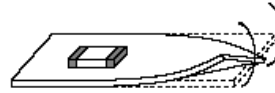

## 10-11. Storage Conditions

### (1) Storage period

Use the products within 6 months after delivered.

Solderability should be checked if this period is exceeded.

### (2) Storage conditions

- Products should be stored in the warehouse on the following conditions.

Temperature : -10°C to 40°C

Humidity : 15% to 85% relative humidity

No rapid change on temperature and humidity

- Don't keep products in corrosive gases such as sulfur, chlorine gas or acid, or it may cause oxidization of electrode, resulting in poor solderability.
- Products should be stored on the palette for the prevention of the influence from humidity, dust and so on.
- Products should be stored in the warehouse without heat shock, vibration, direct sunlight and so on.
- Avoid storing the product by itself bare (i.e. exposed directly to air).

### (3) Delivery

Care should be taken when transporting or handling product to avoid excessive vibration or mechanical shock.

## 11. ⚠ Note

- (1) Please make sure that your product has been evaluated in view of your specifications with our product being mounted to your product.
- (2) You are requested not to use our product deviating from the reference specifications.
- (3) The contents of this reference specification are subject to change without advance notice. Please approve our product specifications or transact the approval sheet for product specifications before ordering.

# Mouser Electronics

Authorized Distributor

Click to View Pricing, Inventory, Delivery & Lifecycle Information:

## Murata:

[BLM02AX700SN1B](#) [BLM02AX121SN1D](#) [BLM02AX100SN1B](#) [BLM02AX700SN1D](#) [BLM02AX100SN1D](#)  
[BLM02AX121SN1B](#) [BLM02BX151SN1D](#) [BLM02PX330SN1D](#) [BLM02PX100SN1D](#) [BLM02AX241SN1D](#)  
[BLM02BX241SN1D](#) [BLM02PX600SN1D](#) [BLM02PX220SN1D](#) [BLM02BX121SN1D](#) [BLM02AX331SN1D](#)  
[BLM02KX180SN1D](#) [BLM02KX100SN1D](#)