

## Features

- RoHS compliant\*
- Low profile
- Low power loss, high efficiency
- UL 94V-0 classification

## Applications

- Switch Mode Power Supplies
- Portable equipment batteries
- High frequency rectification
- DC/DC Converters
- Telecommunications

# CD214C-FS3x Series Fast Response Rectifier Chip Diode

## General Information

Portable communications, computing and video equipment manufacturers are challenging the semiconductor industry to develop increasingly smaller electronic components.

Bourns offers Glass Passivated Rectifiers for rectification applications in a compact chip package compatible with DO-214AB (SMC) size format. The Glass Passivated Rectifier Diodes offer a forward current of 3 A with a choice of repetitive peak reverse voltage of 200 V up to 600 V.



## Absolute Maximum Ratings (@ T<sub>A</sub> = 25 °C Unless Otherwise Noted)

Parameter	Symbol	CD214C-			Unit
		FS3D	FS3G	FS3J	
Maximum Repetitive Peak Reverse Voltage	V <sub>RRM</sub>	200	400	600	V
Maximum Average Forward Current	I <sub>F(AV)</sub>	3			A
Maximum Peak Forward Surge Current (8.3 ms Single Half Sine-Wave)	I <sub>FSM</sub>	100			A
Operating Junction Temperature Range	T <sub>OPR</sub>	-65 to +175			°C
Storage Temperature Range	T <sub>STG</sub>	-65 to +175			°C

## Electrical Characteristics (@ T<sub>A</sub> = 25 °C Unless Otherwise Noted)

Parameter	Symbol	Condition or Model	Min.	Typ.	Max.	Unit	
Maximum Instantaneous Forward Voltage (NOTE 1)	V <sub>F</sub>	I <sub>F</sub> = 3 A	CD214C-FS3D		0.93	0.95	V
			CD214C-FS3G		1.2	1.25	
			CD214C-FS3J		1.4	1.7	
DC Reverse Current	I <sub>R</sub>	V <sub>R</sub> = V <sub>RRM</sub>		0.2	5	μA	
Reverse Recovery Time	T <sub>rr</sub>	I <sub>F</sub> = 0.5 A, I <sub>R</sub> = 1.0 A, I <sub>rr</sub> = 0.25 A		35		nS	
Typical Junction Capacitance	C <sub>J</sub>	V <sub>R</sub> = 4 V, f = 1.0 MHz		19		pF	
Typical Thermal Resistance (NOTE 2)	Junction to Ambient	R <sub>θJA</sub>		60		°C/W	
	Junction to Lead	R <sub>θJL</sub>		10			

### NOTES:

(1) Pulse width 300 microsecond, 1 % duty cycle.

(2) Mounted on PCB with 5.0 x 5.0 mm (0.2 x 0.2 inch) copper pad areas.

\*RoHS Directive 2002/95/EC Jan. 27, 2003 including annex and RoHS Recast 2011/65/EU June 8, 2011.

Specifications are subject to change without notice.

The device characteristics and parameters in this data sheet can and do vary in different applications and actual device performance may vary over time. Users should verify actual device performance in their specific applications.

# CD214C-FS3x Series Fast Response Rectifier Chip Diode



## Performance Graphs

### Forward Current Derating Curve

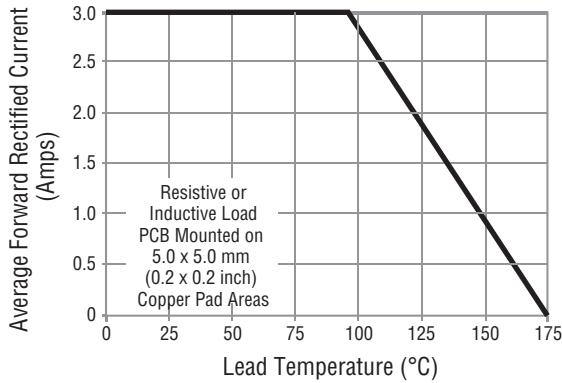

### Maximum Peak Forward Surge Current

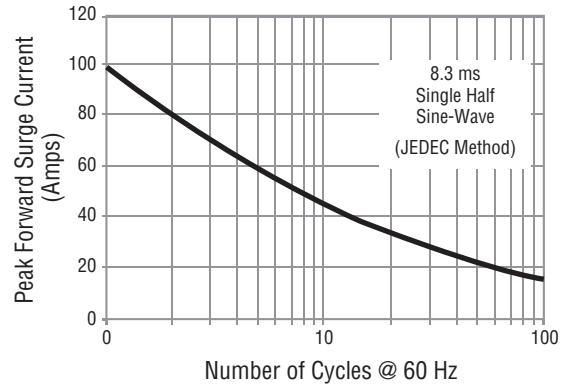

### Typical Instantaneous Forward Characteristics

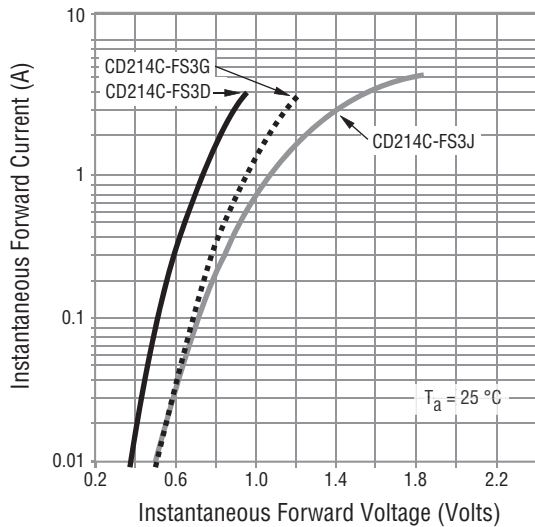

### Typical Reverse Characteristics

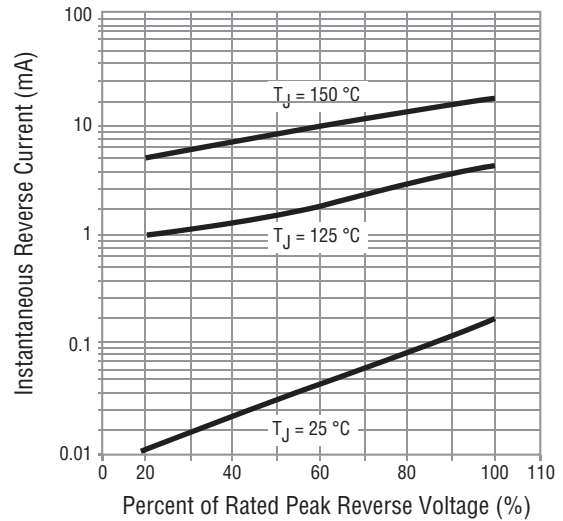

### Typical Junction Capacitance

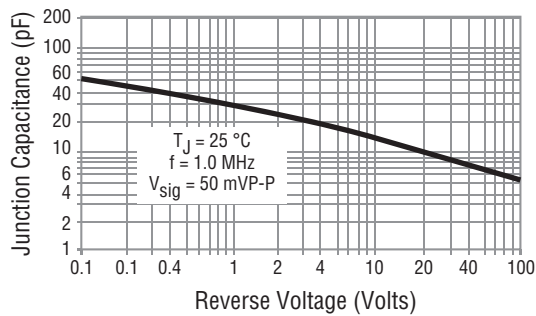

Specifications are subject to change without notice. The device characteristics and parameters in this data sheet can and do vary in different applications and actual device performance may vary over time. Users should verify actual device performance in their specific applications.

# CD214C-FS3x Series Fast Response Rectifier Chip Diode



## Product Dimensions

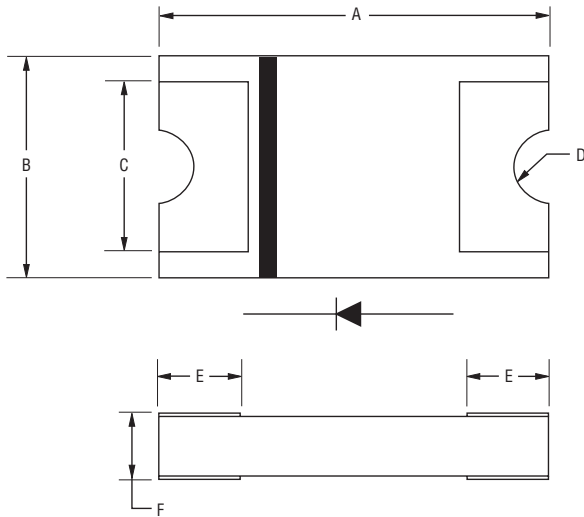

Dimension	CD214C-FS Series
A	$\frac{8.0 \pm 0.10}{(0.315 \pm 0.004)}$
B	$\frac{5.0 \pm 0.10}{(0.197 \pm 0.004)}$
C	$\frac{3.90}{(0.154)}$ TYP.
D	$\frac{0.80 \pm 0.02}{(0.031 \pm 0.001)}$
E	$\frac{1.95 \pm 0.10}{(0.077 \pm 0.004)}$
F	$\frac{1.10 \pm 0.15}{(0.043 \pm 0.006)}$

DIMENSIONS:  $\frac{\text{MM}}{\text{(INCHES)}}$

## Recommended Pad Layout

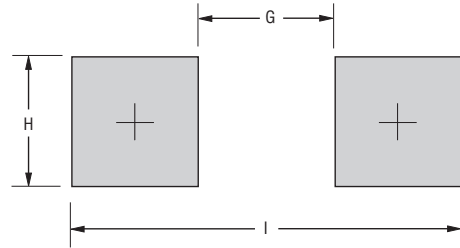

Dimension	CD214C-FS Series
G	$\frac{4.10}{(0.161)}$ MAX.
H	$\frac{3.90}{(0.154)}$ MIN.
I	$\frac{11.90}{(0.469)}$ REF.

DIMENSIONS:  $\frac{\text{MM}}{\text{(INCHES)}}$

## Environmental Specifications

Moisture Sensitivity Level..... 1  
 ESD Classification (HBM)..... 3B

## Typical Part Marking

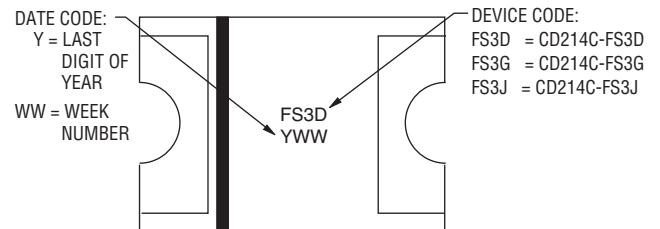

## How to Order

**CD 214C - FS 3 D**

Common Code \_\_\_\_\_  
 CD = Chip Diode  
 Package \_\_\_\_\_  
 214C = SMC/DO-214AB Compatible  
 Model \_\_\_\_\_  
 FS = Fast Response Rectifier  
 Maximum Average Forward Rectified Current \_\_\_\_\_  
 3 = 3 A  
 Maximum Repetitive Peak Reverse Voltage \_\_\_\_\_  
 D = 200 V  
 G = 400 V  
 J = 600 V

Specifications are subject to change without notice.  
 The device characteristics and parameters in this data sheet can and do vary in different applications and actual device performance may vary over time.  
 Users should verify actual device performance in their specific applications.

# CD214C-FS3x Series Fast Response Rectifier Chip Diode

**BOURNS®**

## Packaging Information

The product is dispensed in tape and reel format (see diagram below).

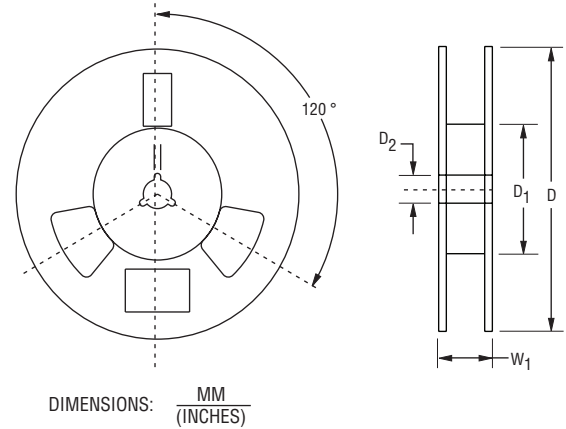
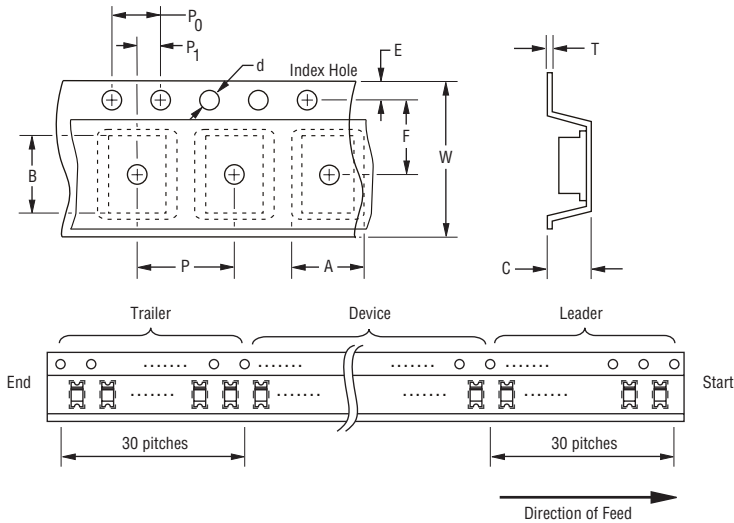

DIMENSIONS:  $\frac{\text{MM}}{\text{(INCHES)}}$

Item	Symbol	CD214C-FS3 Series
Carrier Width	A	$\frac{5.56 \pm 0.10}{(0.219 \pm 0.004)}$
Carrier Length	B	$\frac{8.18 \pm 0.10}{(0.322 \pm 0.004)}$
Carrier Depth	C	$\frac{2.50}{(0.098)}$ MAX.
Sprocket Hole	d	$\frac{1.55 \pm 0.05}{(0.061 \pm 0.002)}$
Reel Outside Diameter	D	$\frac{330 \pm 2.0}{(12.992 \pm 0.079)}$
Reel Inner Diameter	D <sub>1</sub>	$\frac{50.0}{(1.969)}$ MIN.
Feed Hole Diameter	D <sub>2</sub>	$\frac{13.0 \pm 0.50}{(0.512 \pm 0.020)}$
Sprocket Hole Position	E	$\frac{1.75 \pm 0.10}{(0.069 \pm 0.004)}$
Punch Hole Position	F	$\frac{7.50 \pm 0.10}{(0.295 \pm 0.004)}$
Punch Hole Pitch	P	$\frac{8.00 \pm 0.10}{(0.315 \pm 0.004)}$
Sprocket Hole Pitch	P <sub>0</sub>	$\frac{4.00 \pm 0.10}{(0.157 \pm 0.004)}$
Embossment Center	P <sub>1</sub>	$\frac{2.00 \pm 0.10}{(0.079 \pm 0.004)}$
Overall Tape Thickness	T	$\frac{0.40}{(0.016)}$ MAX.
Tape Width	W	$\frac{16.00 \pm 0.30}{(0.630 \pm 0.012)}$
Reel Width	W <sub>1</sub>	$\frac{22.7}{(0.893)}$ MAX.
Quantity per Reel	--	3,000

**BOURNS®**

### Asia-Pacific:

Tel: +886-2 2562-4117

Email: asiacus@bourns.com

### Europe:

Tel: +36 88 520 390

Email: eurocus@bourns.com

### The Americas:

Tel: +1-951 781-5500

Email: americus@bourns.com

[www.bourns.com](http://www.bourns.com)

01/18

Specifications are subject to change without notice. The device characteristics and parameters in this data sheet can and do vary in different applications and actual device performance may vary over time. Users should verify actual device performance in their specific applications.

# Mouser Electronics

Authorized Distributor

Click to View Pricing, Inventory, Delivery & Lifecycle Information:

Bourns:

[CD214C-FS3D](#) [CD214C-FS3J](#) [CD214C-FS3G](#)