



## MMIC SURFACE MOUNT

# IQ Mixer

## SMIQ-6243H+

50Ω Level 18 (LO Power +18dBm) 6 to 24 GHz

### THE BIG DEAL

- Wideband RF & LO, 6 to 24 GHz
- Wideband IF, DC to 6 GHz
- Excellent Image Rejection, Typ. 32dB
- High LO-RF Isolation, Typ. 41 dB
- High Input IP3, Typ. +25 dBm
- Usable as Image Reject Mixer & SSB Converter
- 4x4 mm, 24-Lead QFN- Style Package

### APPLICATIONS

- Test and Measurement Equipment
- 5G mmWave and Back Haul Radio
- Satellite Communications
- Radar, EW and ECM Defense Systems

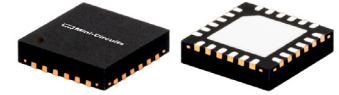

Generic photo used for illustration purposes only

### FUNCTIONAL DIAGRAM

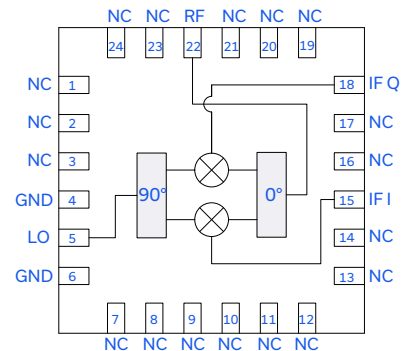

### PRODUCT OVERVIEW

The SMIQ-6243H+ is a passive, wideband in phase/quadrature (I/Q) mixer fabricated using GaAs HBT technology. The SMIQ-6243H+ is usable as a single-sideband upconverter for transmit applications or an image rejection mixer for receiver applications. The SMIQ-6243H+ is ideal for wideband frequency translation applications that require inherent rejection of image signals and spurious mixing products. The mixer covers a wide frequency range with RF and LO frequency range of 6 to 24 GHz and an IF frequency range of DC to 6 GHz. As a passive mixer, the SMIQ-6243H+ offers lower noise figure than active mixers ensuring superior dynamic range for high performance applications. The mixer is housed in a compact 4x4 mm QFN style package and no DC bias is needed for operation.

### KEY FEATURES

Feature	Advantages
High Image Rejection, 32 dB typical	Provides inherent rejection of unwanted image signals without the need to external filtering
High LO-RF Isolation, 41 dB typical	Enables excellent carrier rejection in single-sideband operation upconvert transmit applications
High LO-IF Isolation, 43 dB typical	Minimizes filtering requirements needed to ensure signal integrity
Wide Bandwidth, 6 to 24 GHz	Useful in wideband systems or in several narrowband systems requiring fewer components
Wide IF Bandwidth, DC to 6 GHz	Useable for first and second down converter applications. IF as low as DC enables use in phase detector applications.
Small size, 4x4 MCLP package.	Tiny footprint saves space in dense layouts while providing low inductance, repeatable transitions, and excellent thermal contact to the PCB.

**ELECTRICAL SPECIFICATIONS<sup>1</sup> AT 25°C, Zo=50Ω, LO POWER = +18 dBm, UNLESS OTHERWISE NOTED.**

Parameter	Frequency (GHz)	Min.	Typ.	Max.	Unit
RF Frequency Range		6		24	GHz
LO Frequency Range		6		24	GHz
IF Frequency Range		DC		6	GHz
LO Power		+17	+18	+20	dBm
Conversion Loss <sup>2</sup>	6 - 20		8.3	10.7	dB
	20 - 24		9.8	11.6	
Amplitude Unbalance	6 - 20		±0.1	±1.6	dB
	20 - 24		±0.1	±0.7	
Phase Unbalance (Relative to 90°)	6 - 20		4	13	deg
	20 - 24		2	6	
Image Rejection <sup>3</sup> (Tested as a Downconverter)	6 - 20		30		dBc
	20 - 24		37		
Single Sideband Rejection <sup>4</sup> (Tested as an Upconverter)	6 - 20		31		dBc
	20 - 24		29		
LO-RF Isolation	6 - 20	34	42		dB
	20 - 24	30	37		
LO-I Isolation	6 - 20	30	47		dB
	20 - 24	22	31		
LO-Q Isolation	6 - 20	32	45		dB
	20 - 24	24	33		
RF-I Isolation	6 - 20	17	37		dB
	20 - 24	23	40		
RF-Q Isolation	6 - 20	18	41		dB
	20 - 24	24	43		
Input Power at 1dB Compression	6 - 24		+10		dBm
Input IP3 (I) Lower Side Band	6 - 20		+20		dBm
	20 - 24		+25		
Input IP3 (Q) Lower Side Band	6 - 20		+20		dBm
	20 - 24		+25		
Input IP3 (I) Upper Side Band	6 - 20		+20		dBm
	20 - 24		+25		
Input IP3 (Q) Upper Side Band	6 - 20		+20		dBm
	20 - 24		+25		

1. Measured on Mini-Circuits Characterization/Evaluation Test Board TB-SMIQ-6243HC+. See Figures 2, 3, & 4. Board loss de-embedded to the device. Unless otherwise specified, IF = 200 MHz

2. Conversion loss (dB) = RF Power (dBm) minus worse of I/Q Port Power (dBm) minus 3dB theoretical loss of an Ideal External Hybrid, measured as a Down Converter. See measurement block diagram Figure 2.

3. Level of undesired image signal below desired RF signal. See measurement block diagram Figure 3.

4. Level of undesired sideband below desired sideband. See measurement Block Diagram Figure 3.



### TYPICAL PERFORMANCE GRAPHS

**IMAGE REJECTION (DOWNCONVERTER)  
@ IF = 200 MHz**

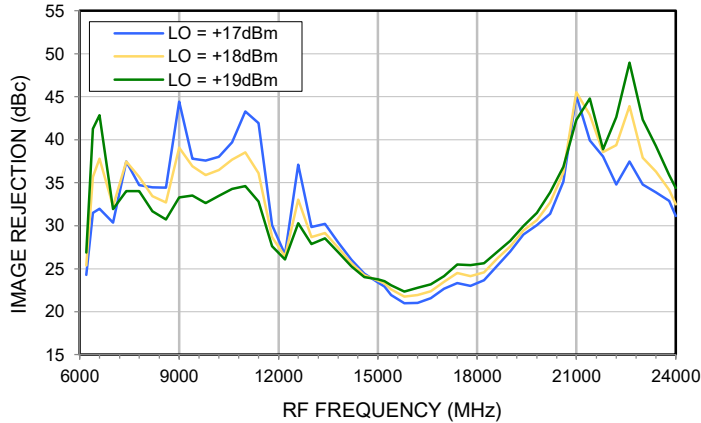

**SSB REJECTION (UPCONVERTER)  
@ IF = 200 MHz**

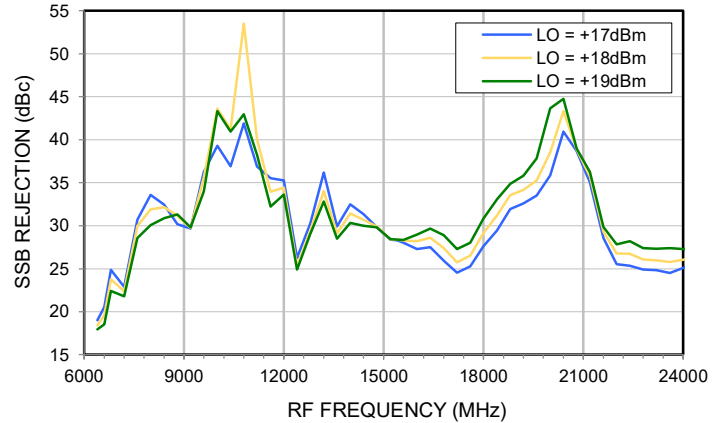

**IMAGE REJECTION (DOWNCONVERTER)  
@ IF = 2000 MHz**

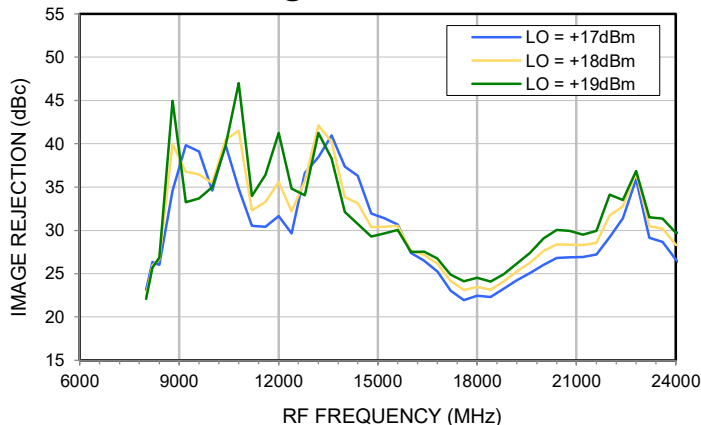

**SSB REJECTION (UPCONVERTER)  
@ IF = 2000 MHz**

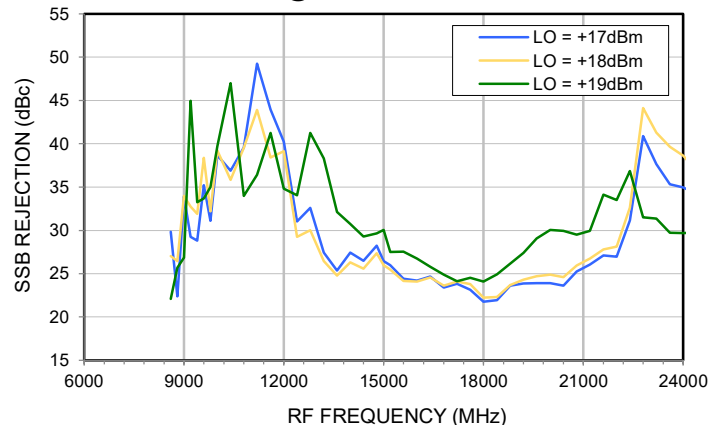

**IMAGE REJECTION (DOWNCONVERTER)  
@ IF = 3000 MHz**

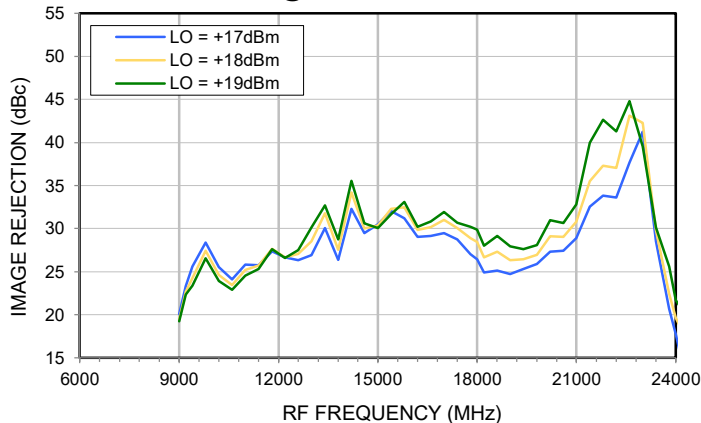

**SSB REJECTION (UPCONVERTER)  
@ IF = 3000 MHz**

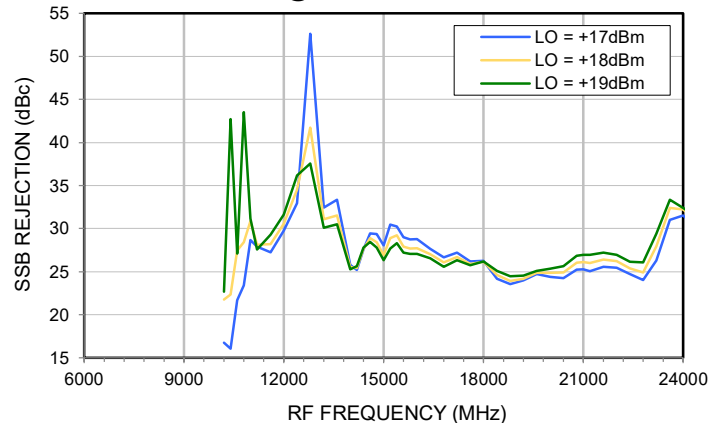



### TYPICAL PERFORMANCE GRAPHS

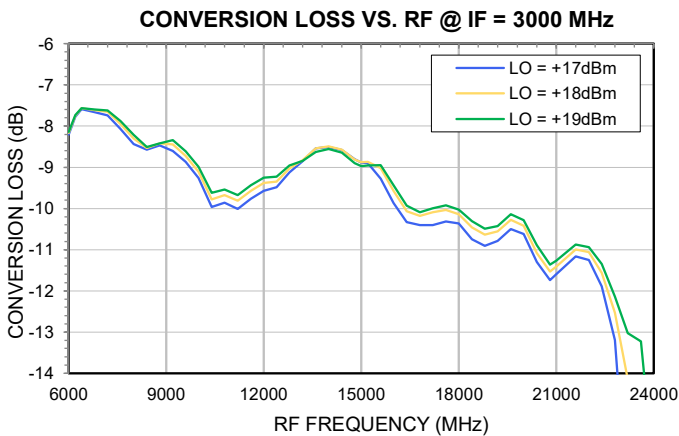
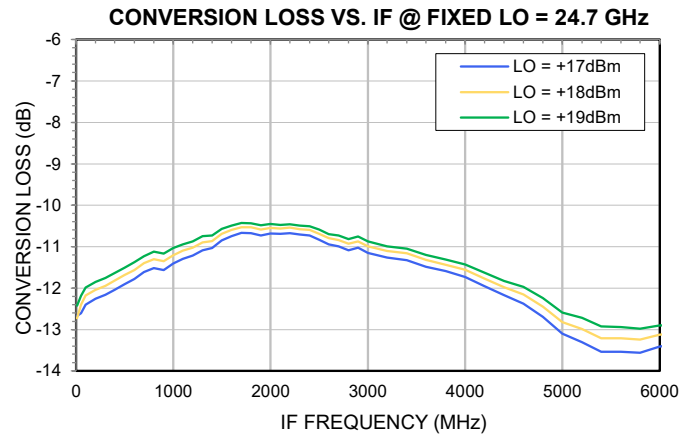
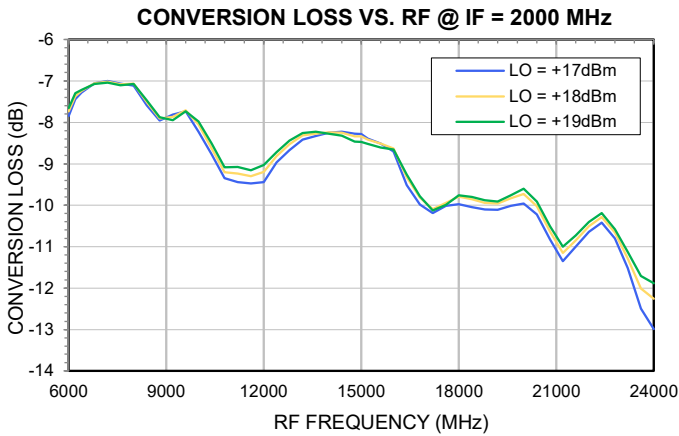
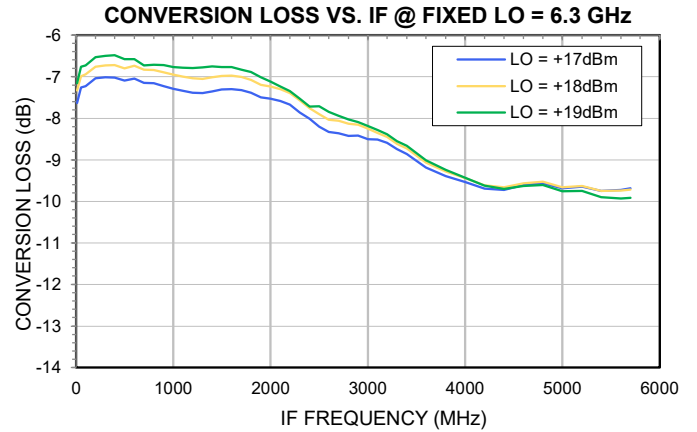
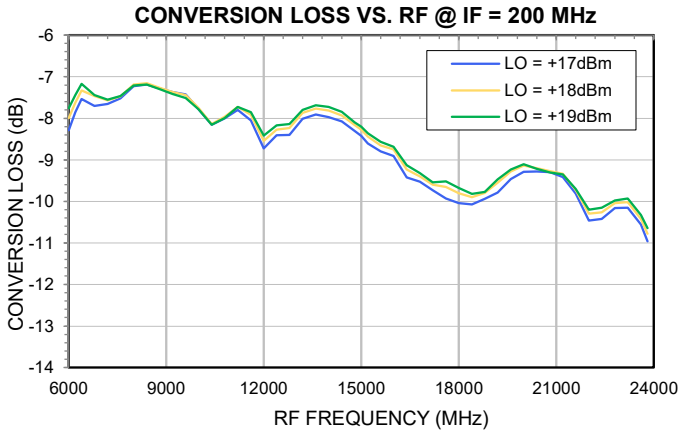



### TYPICAL PERFORMANCE GRAPHS

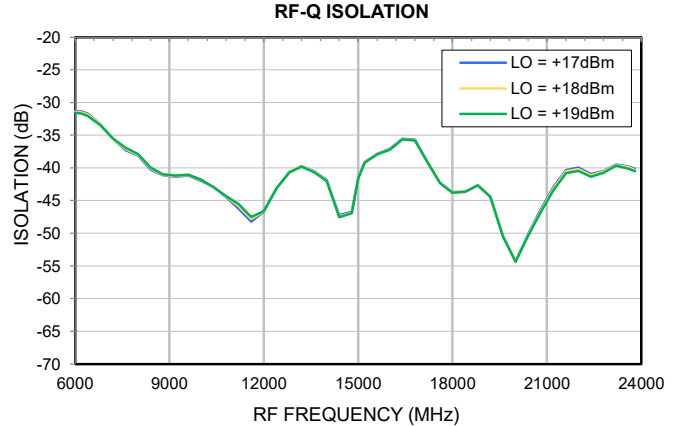
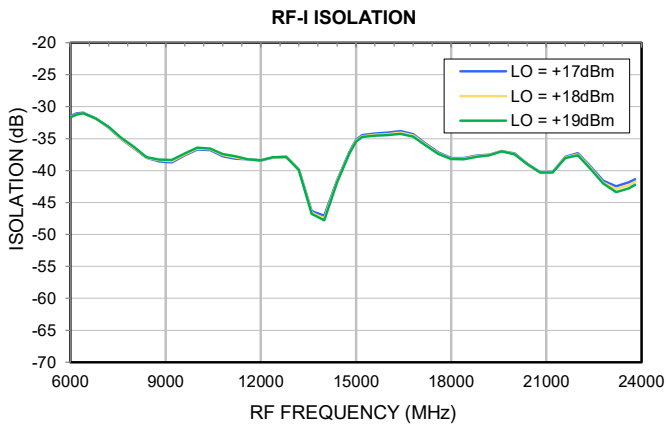
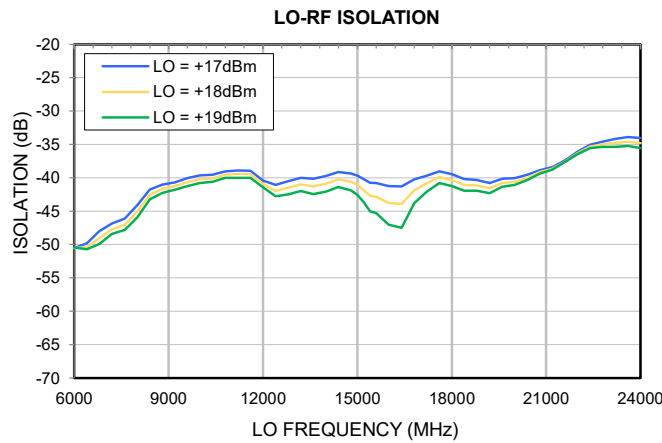
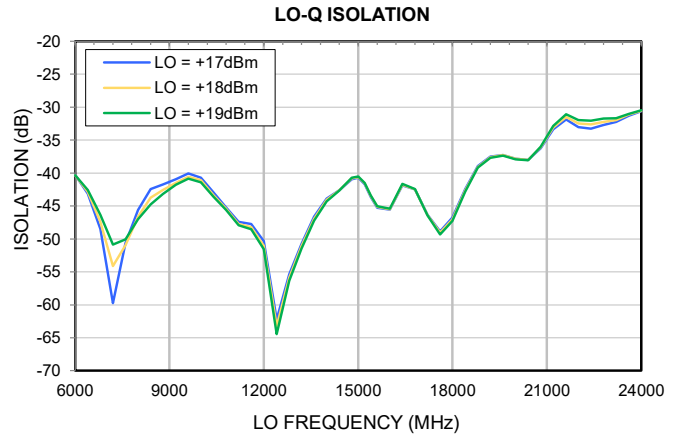
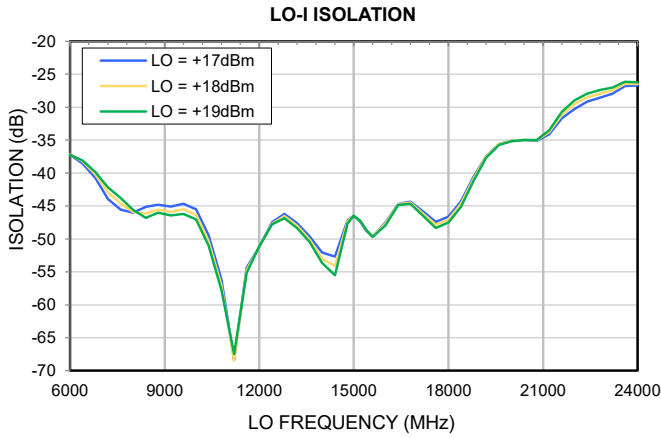



### TYPICAL PERFORMANCE GRAPHS

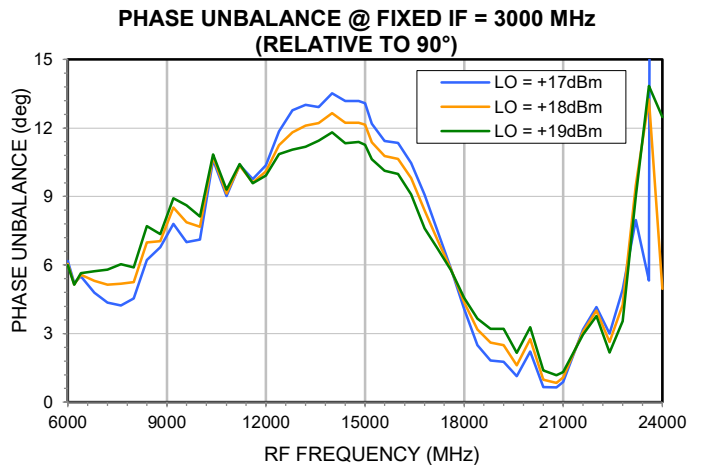
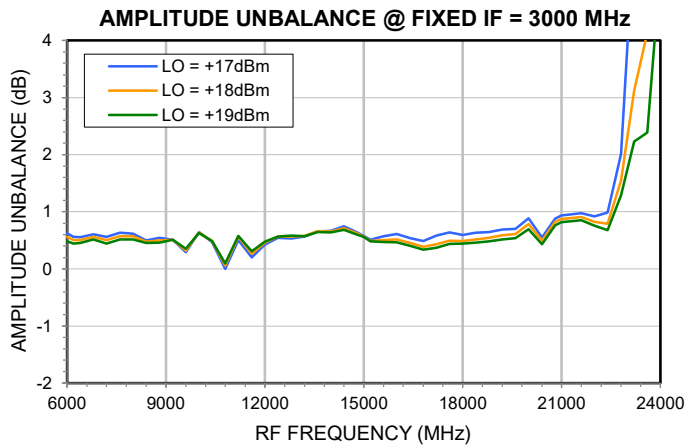
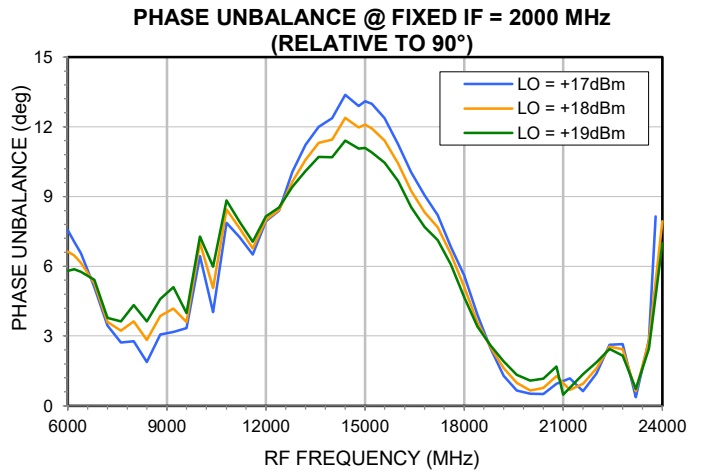
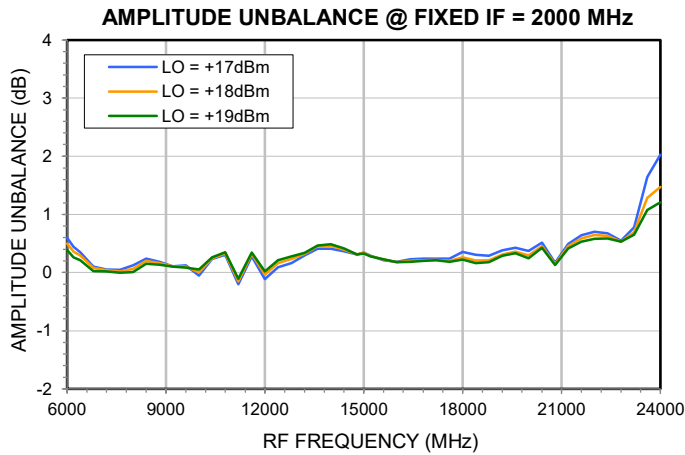
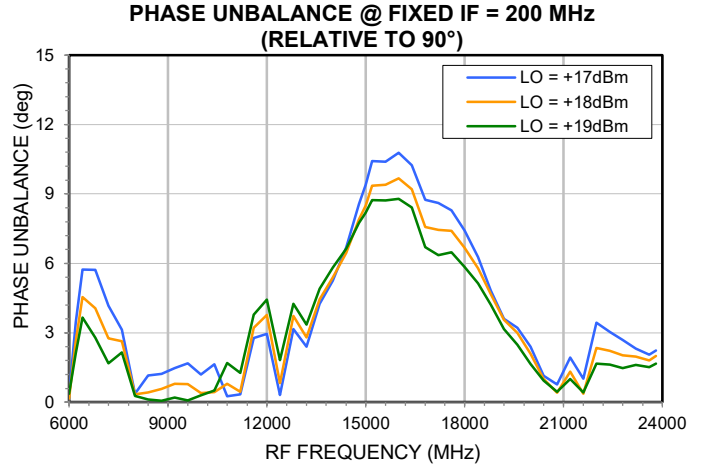
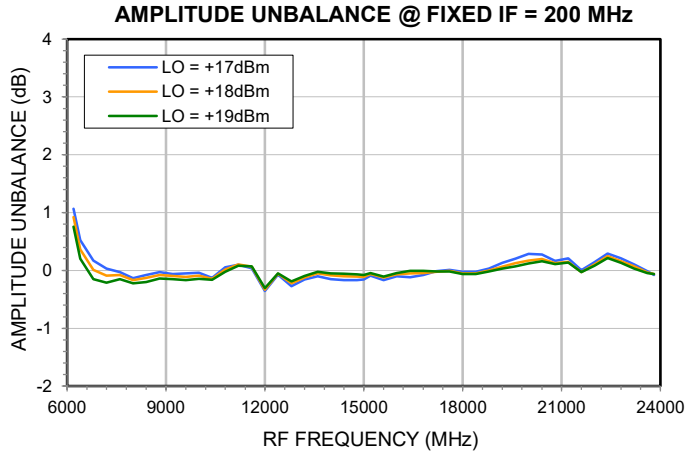



### TYPICAL PERFORMANCE GRAPHS

**GAIN COMPRESSION (I) @ FIXED IF = 200 MHz**  
RF INPUT POWER = +10dBm

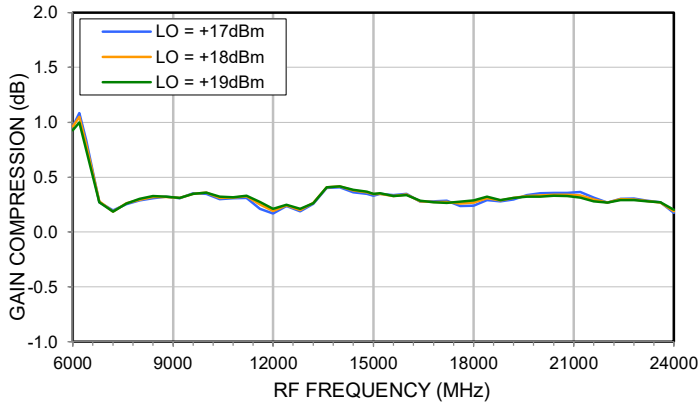

**GAIN COMPRESSION (Q) @ FIXED IF = 200 MHz**  
RF INPUT POWER = +10dBm

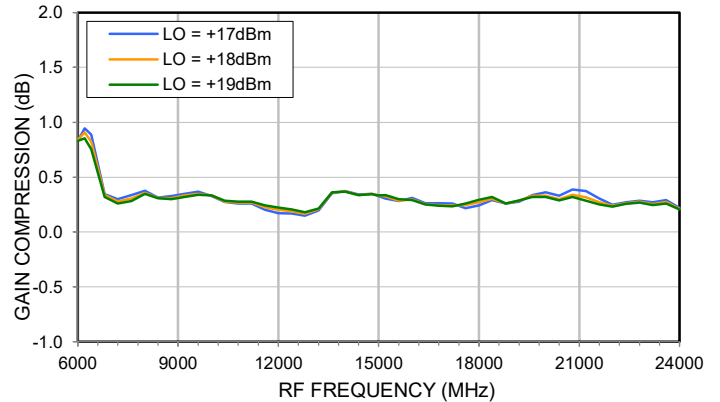

**GAIN COMPRESSION (I) @ FIXED IF = 2000 MHz**  
RF INPUT POWER = +10dBm

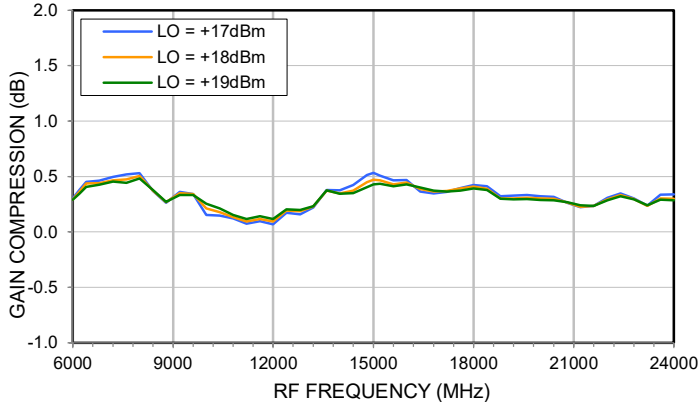

**GAIN COMPRESSION (Q) @ FIXED IF = 2000 MHz**  
RF INPUT POWER = +10dBm

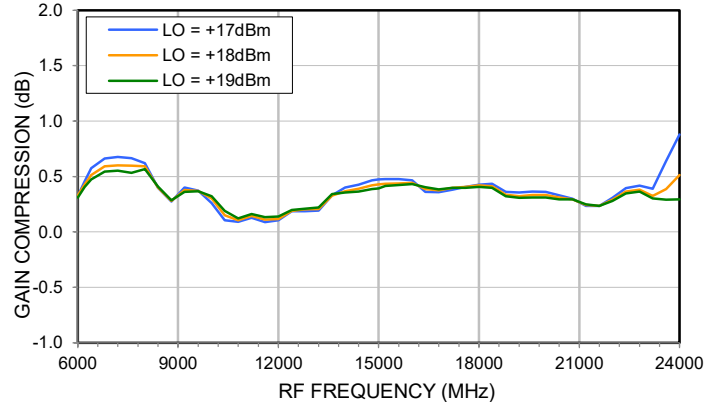

**GAIN COMPRESSION (I) @ FIXED IF = 3000 MHz**  
RF INPUT POWER = +10dBm

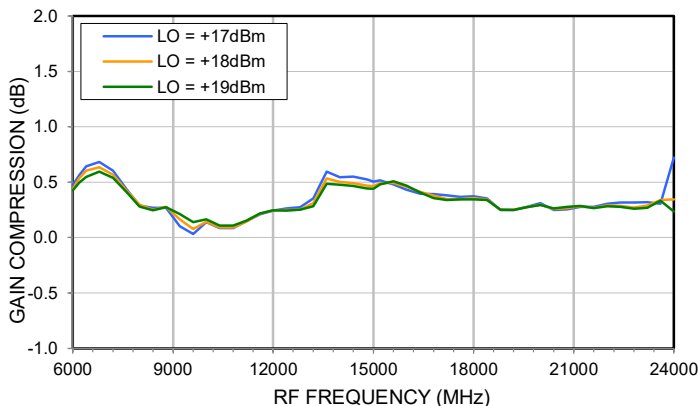

**GAIN COMPRESSION (Q) @ FIXED IF = 3000 MHz**  
RF INPUT POWER = +10dBm

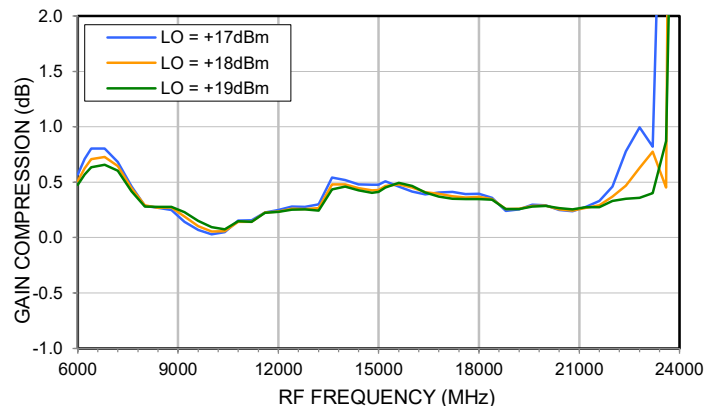



### TYPICAL PERFORMANCE GRAPHS

$P_{IN} = -10$  dBm/Tone with 1 MHz spacing (RF2 = RF1 + 1 MHz)

**INPUT IP3 LOWER SIDE BAND (I)**  
@ FIXED IF = 200 MHz

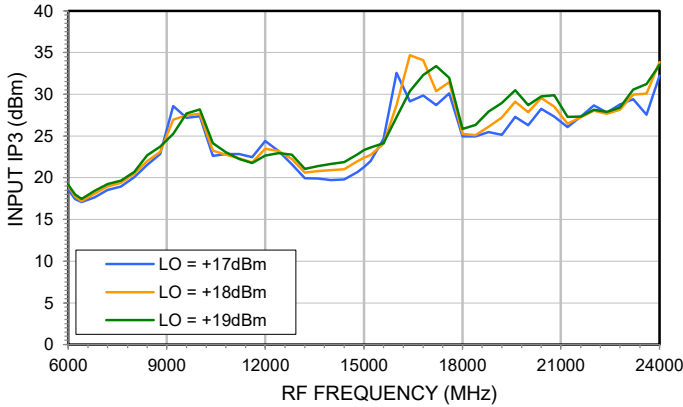

**INPUT IP3 LOWER SIDE BAND (Q)**  
@ FIXED IF = 200 MHz

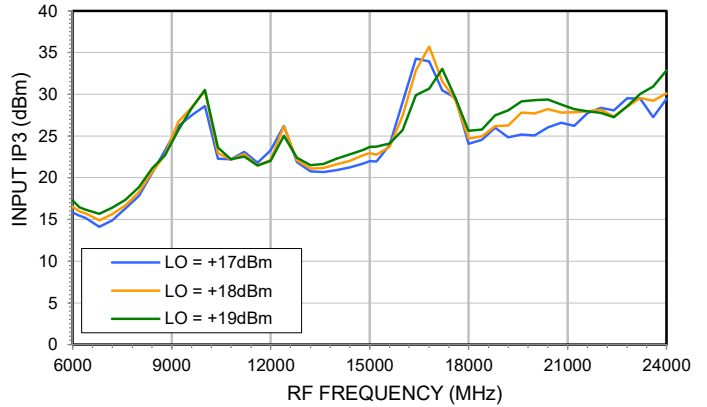

**INPUT IP3 UPPER SIDE BAND (I)**  
@ FIXED IF = 200 MHz

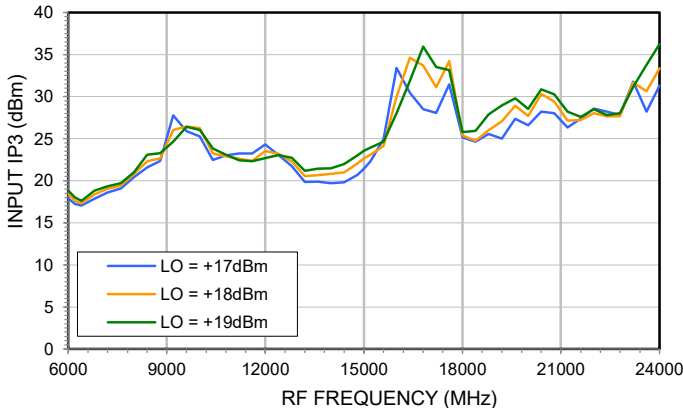

**Input IP3 UPPER SIDE BAND (Q)**  
@ FIXED IF = 200 MHz

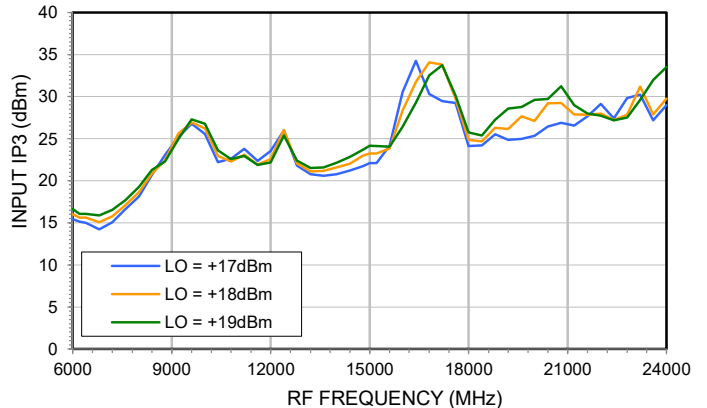

**INPUT IP3 LOWER SIDE BAND (I)**  
@ FIXED IF = 2000 MHz

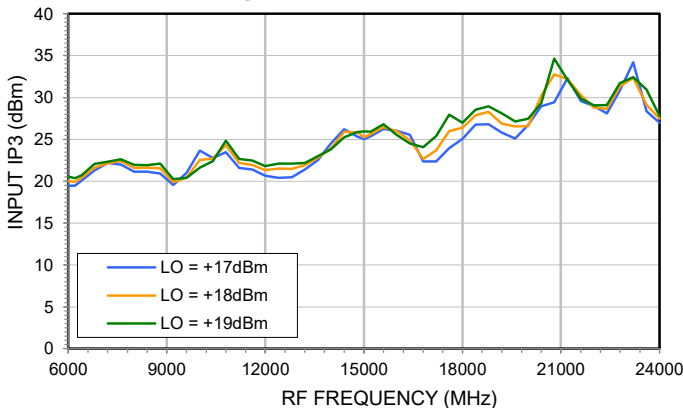

**INPUT IP3 LOWER SIDE BAND (Q)**  
@ FIXED IF = 2000 MHz

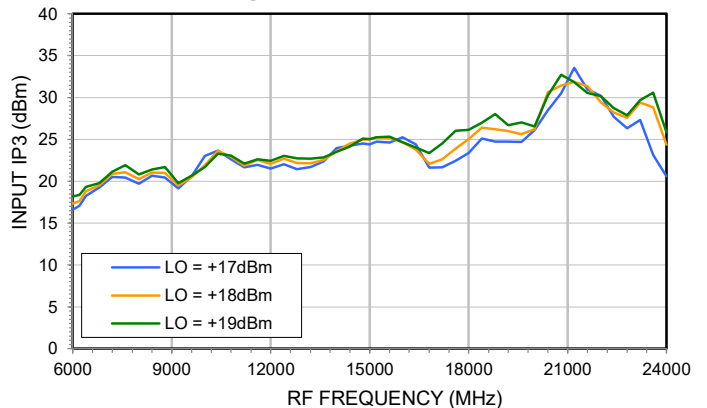





### TYPICAL PERFORMANCE GRAPHS

$P_{IN} = -10$  dBm/Tone with 1 MHz spacing (RF2 = RF1 + 1 MHz)

**INPUT IP3 UPPER SIDE BAND (I)  
@ FIXED IF = 2000 MHz**

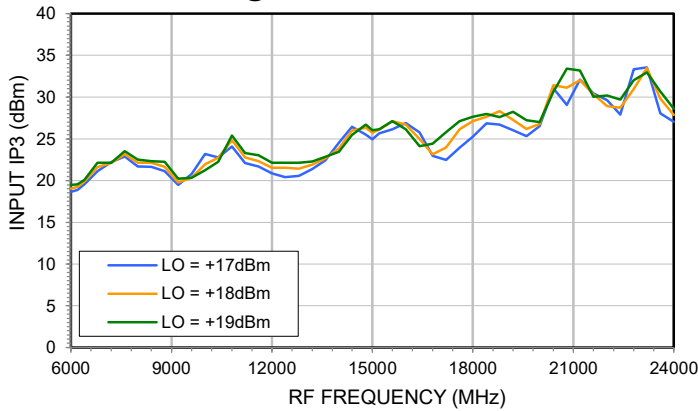

**INPUT IP3 UPPER SIDE BAND (Q)  
@ FIXED IF = 2000 MHz**

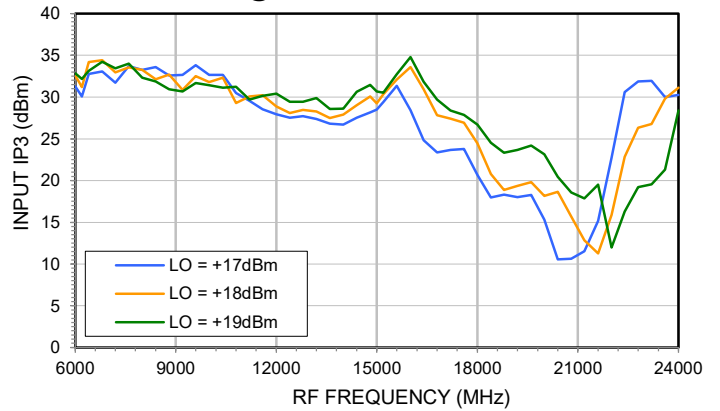

**INPUT IP3 LOWER SIDE BAND (I)  
@ FIXED IF = 3000 MHz**

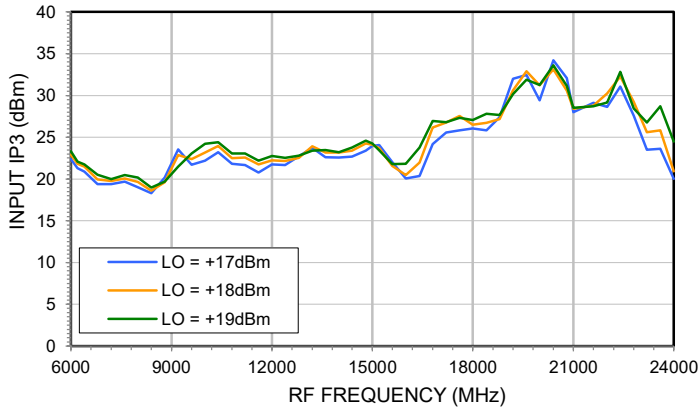

**INPUT IP3 LOWER SIDE BAND (Q)  
@ FIXED IF = 3000 MHz**

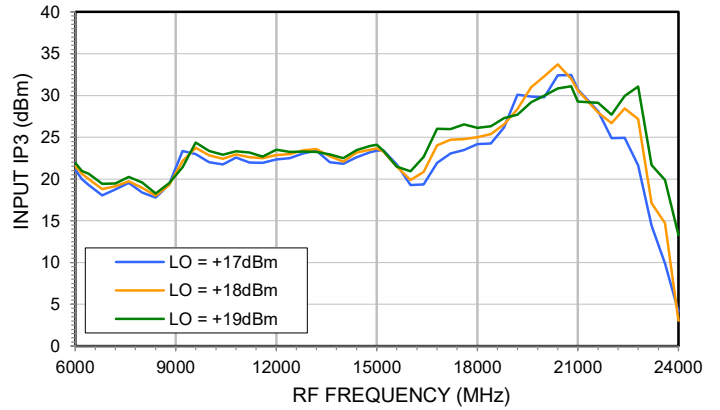

**INPUT IP3 UPPER SIDE BAND (I)  
@ FIXED IF = 3000 MHz**

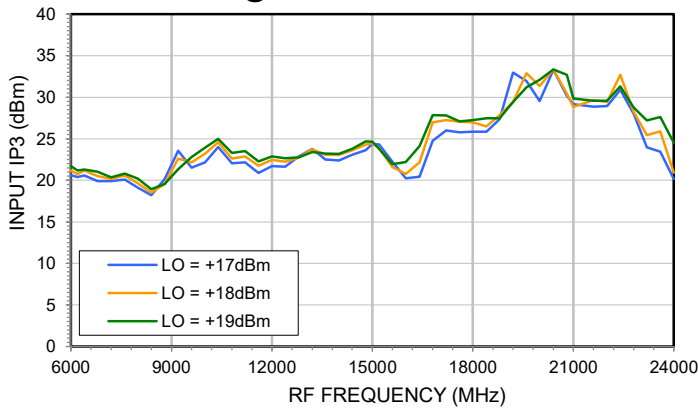

**INPUT IP3 LOWER SIDE BAND (Q)  
@ FIXED IF = 3000 MHz**

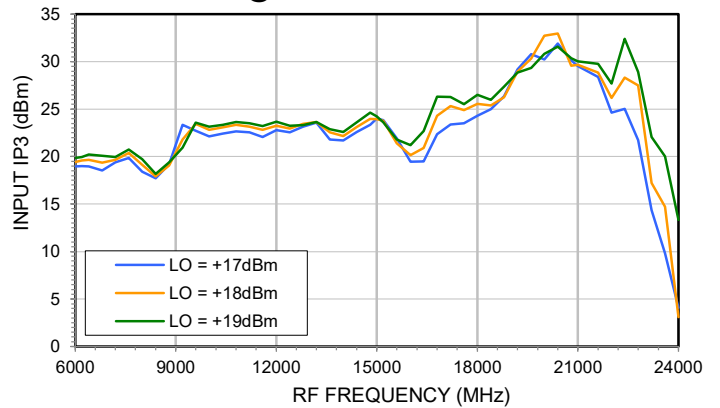



### ABSOLUTE MAXIMUM RATINGS<sup>5</sup>

Parameter	Ratings
Operating Temperature	-40°C to 85°C
Storage Temperature	-65°C to 150°C
Maximum Junction Temperature	175 °C
RF Power	+25 dBm
LO Power	+25 dBm
IF Current	16 mA

5. Permanent damage may occur if any of these limits are exceeded. Electrical maximum ratings are not intended for continuous normal

### ESD RATING

	Class	Voltage Range	Reference Standard
HBM	1A	250 to <500V	ANSI/ESDA/JEDEC JS-001-2017
CDM	C4	500 to <1000V	JESD22-C101F



ESD HANDLING PRECAUTION: This device is designed to be Class 1A for HBM. Static charges may easily produce potentials higher than this with improper handling and can discharge into DUT and damage it. As a preventive measure Industry standard ESD handling precautions should be used at all times to protect the device from ESD damage.

### MSL RATING

Moisture Sensitivity: MSL1 in accordance with IPC/JEDEC J-STD-020E /JEDEC J-STD-033C.



### FUNCTIONAL DIAGRAM

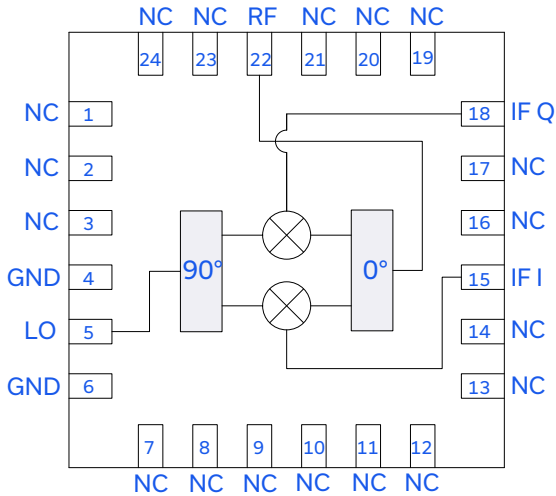

### PAD CONNECTIONS

Function	Pad #	Description
RF	22	RF Port. Connects to RF Output for Up converters or RF Input for Down converters.
LO	5	LO Port. Connects to LO Input.
IF I	15	IF I Port. Connects to the IF I Input for Up converters or IF I Output for Down converters.
IF Q	18	IF Q Port. Connects to the IF Q Input for Up converters or IF Q Output for Down converters.
GND	4, 6, Paddle	Connects to bottom ground.
NC	1-3, 7-14, 16-17, 19-21, 23-24	No connection

Figure 1. SMIQ-6243H+ Functional Diagram

### CHARACTERIZATION TEST CIRCUITS

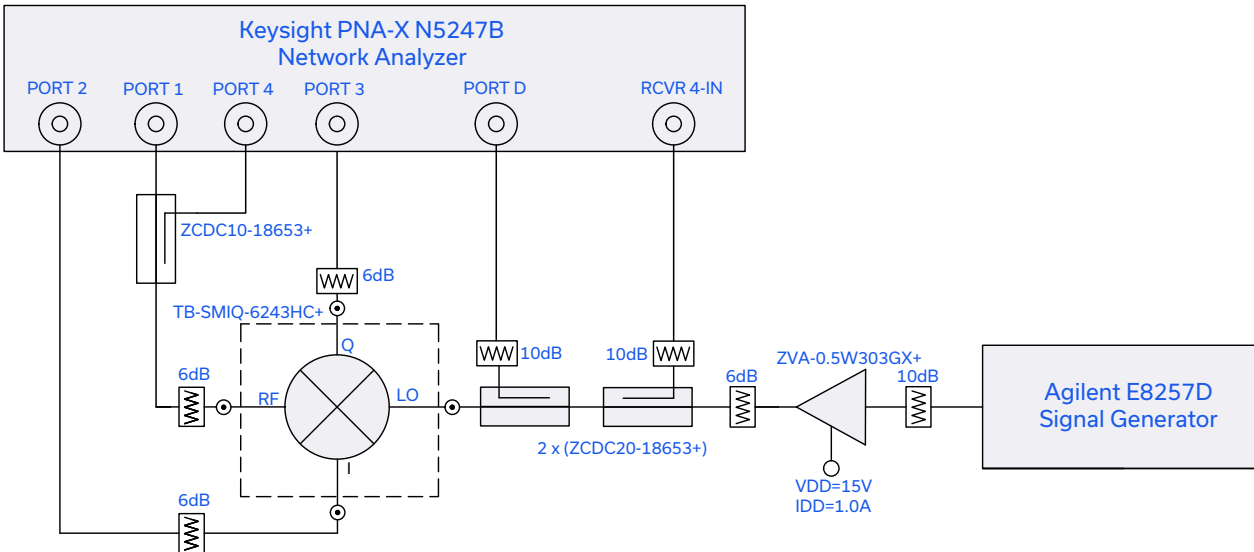

10 dB attenuators P/N BW-E10-1W653+

6 dB attenuators P/N BW-E6-1W653+

Figure 2. Block diagram of test circuit used to characterize: Conversion Loss, Amplitude Unbalance, Phase Unbalance, Isolation, Return Loss, and Input IP3

Test conditions:

For Conversion Loss, Return Loss and Isolation

RF Input Power = -10 dBm, LO Input Power = +17 to +19 dBm, IF = 200 MHz, 2 GHz, and 3 GHz

For Input IP3: RF Input Power = -10 dBm/Tone, LO Input Power = +17 to +19 dBm. Two tones, spaced 1 MHz apart

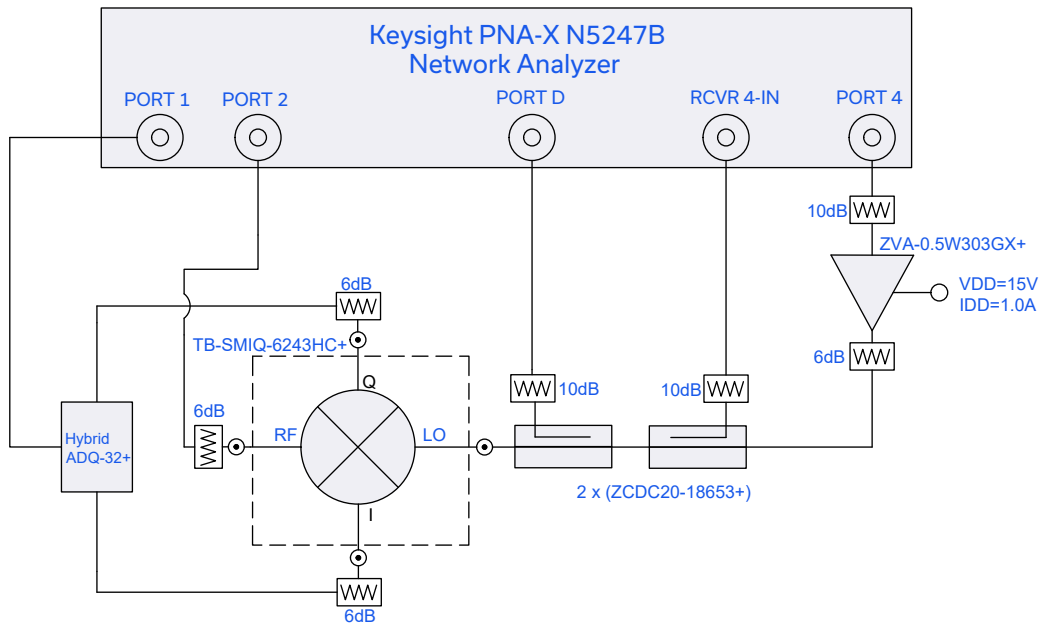

10 dB attenuators P/N BW-E10-1W653+  
 6 dB attenuators P/N BW-E6-1W653+

Figure 3. Block diagram of Test Circuit used for characterization of Image Rejection and Single Side Band Rejection

Test conditions:  
 RF Input Power = -10 dBm, LO Input Power = +17 to +19 dBm, IF = 200 MHz, 2 GHz, and 3 GHz

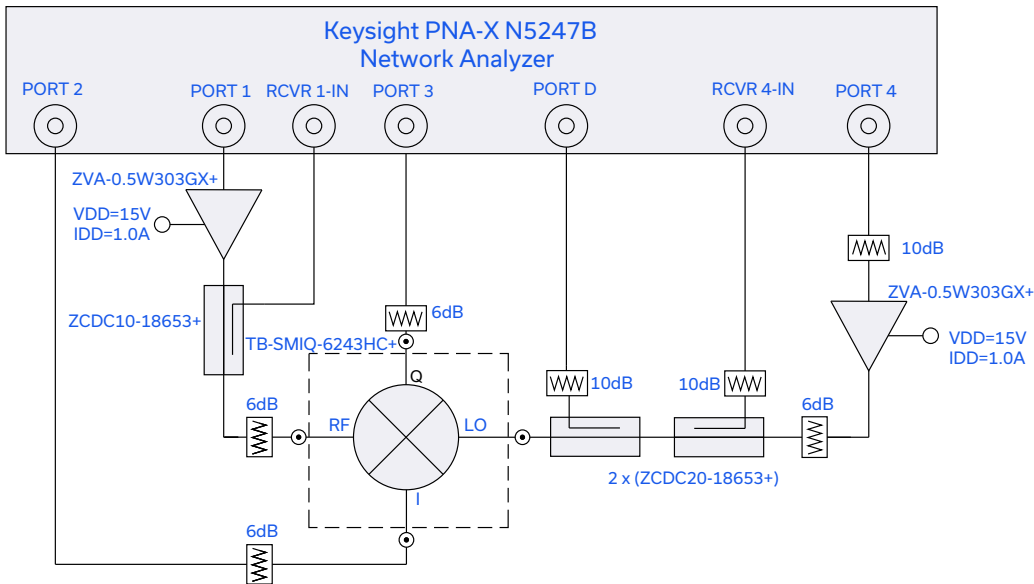

10 dB attenuators P/N BW-E10-1W653+  
 6 dB attenuators P/N BW-E6-1W653+

Figure 4. Block diagram of test circuit used to characterize: Compression

Test conditions:  
 RF Input Power = -10 dBm and +10 dBm, LO Input Power = +17 to +19 dBm, IF = 200 MHz, 2 GHz, and 3 GHz  
 Compression = (Conversion Loss @ RF Power = +10 dBm) - (Conversion Loss @ RF Power = -10 dBm)



### APPLICATION CONFIGURATION FOR IMAGE REJECT AND SINGLE SIDE BAND MIXER

In Image Reject or Single Sideband Upconverter applications an external 90° Hybrid is needed. Refer to Mini-Circuits extensive portofolio of 90° Hybrids.

#### IMAGE REJECT MIXER APPLICATION

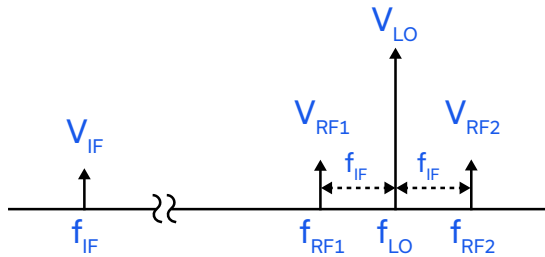

Figure 5. Spectral representation of Signals

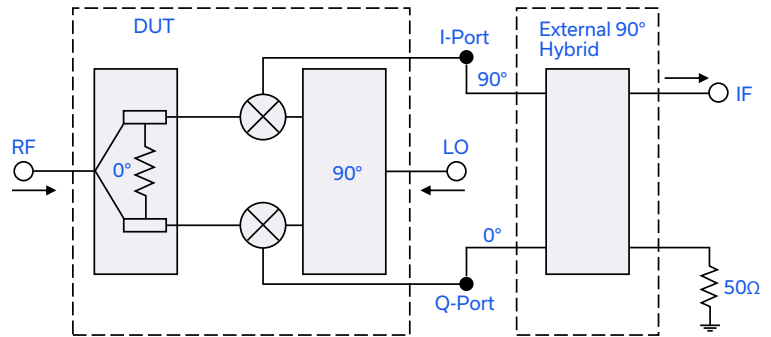

Figure 6. Block Diagram of Image Reject Mixer

If  $f_{RF1}$  is the desired signal and  $f_{RF2}$  is the image, connect the I port of DUT to the 90° port of the external hybrid and the Q port to the 0° port of the hybrid. This will send the  $f_{RF2} - f_{LO}$  IF signal to the terminated output of the external 90° hybrid and desired IF signal  $f_{LO} - f_{RF1}$  to IF port.

If  $f_{RF2}$  is the desired signal and  $f_{RF1}$  is the image signal, connect the I port of DUT to the 0 deg port of the external 90° hybrid and the Q port to the 90° port of the external hybrid. This will send  $f_{LO} - f_{RF1}$  IF signal to the terminated output of the external 90° hybrid and desired IF signal  $f_{RF2} - f_{LO}$  to IF port.

#### SINGLE SIDE BAND (SSB) UPCONVERTER APPLICATION

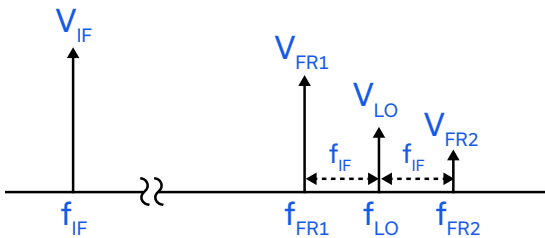

Figure 7. Spectral representation of Signals

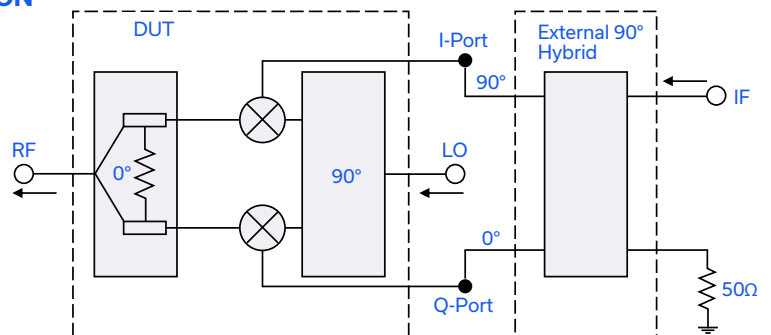

Figure 8. Block Diagram of Single Side Band Mixer

For upper side band selection connect the I port to the 90° port of the external 90° hybrid and the Q port to the 0° port of the external hybrid. This will send the lower sideband band signal to the isolation resistor of the 0° RF splitter in DUT and upper sideband at RF port.

For lower side band selection connect the I port to the 0° port of the external 90° hybrid and the Q port to the 90° port of the hybrid. This will send the upper sideband band signal to the isolation resistor of the 0° RF splitter in DUT and lower sideband out of RF port.

Refer to Mini-Circuits blog, [I&Q Mixers, Image Reject Down-Conversion & Single Sideband \(SSB\) Up-Conversion](#) for a detailed explanation.



### CASE STYLE DRAWING

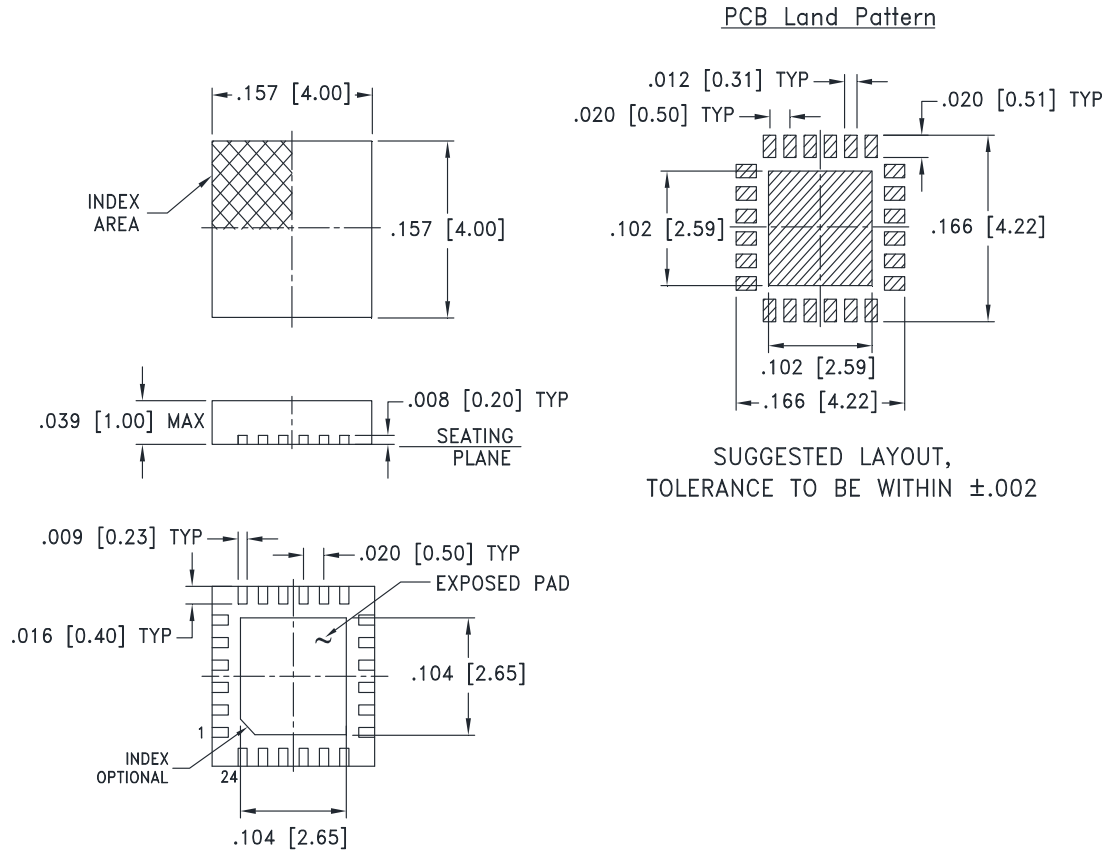

SUGGESTED LAYOUT,  
TOLERANCE TO BE WITHIN  $\pm .002$

Weight: .04 Grams

Dimensions are in inches [mm]. Tolerances: 2 Pl. + .01; 3 Pl. + .005

Figure 9. DG1847 Case Style Drawing

### PRODUCT MARKING

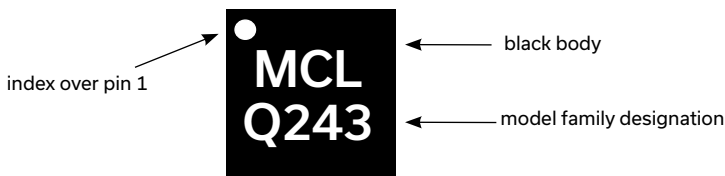

Marking may contain other features or characters for internal lot control

Figure 10. SMIQ-6243H+ Product Marking



MMIC SURFACE MOUNT

# IQ Mixer

## SMIQ-6243H+

50Ω Level 18 (LO Power +18dBm) 6 to 24 GHz

ADDITIONAL DETAILED INFORMATION IS AVAILABLE ON OUR DASH BOARD [CLICK HERE](#)

<b>Performance Data</b>	Data Graphs S-Parameter (S1P Files) Data Set (.zip file)
<b>Case Style</b>	DG1847 Plastic package, exposed paddle, lead finish: Matte-Tin
<b>RoHs Status</b>	Compliant
<b>Tape &amp; Reel</b> Standard quantities available on reel	F68 7" reels with 20, 50, 100, 200, 500 or 1K devices
<b>Suggested Layout for PCB Design</b>	PL-746
<b>Evaluation Board</b>	TB-SMIQ-6243HC+
<b>Environmental Ratings</b>	ENV08T1

Notes

- A. Performance and quality attributes and conditions not expressly stated in this specification document are intended to be excluded and do not form a part of this specification document.
- B. Electrical specifications and performance data contained in this specification document are based on Mini-Circuits' applicable established test performance criteria and measurement instructions.
- C. The parts covered by this specification document are subject to Mini-Circuits' standard limited warranty and terms and conditions (collectively, "Standard Terms"); Purchasers of this part are entitled to the rights and benefits contained there in. For a full statement of the standard. Terms and the exclusive rights and remedies thereunder, please visit Mini-Circuits' website at [www.minicircuits.com/MCLStore/terms.jsp](http://www.minicircuits.com/MCLStore/terms.jsp)
- D. Mini-Circuits does not warrant the accuracy or completeness of the information, text, graphics and other items contained within this document and same are provided as an accommodation and on an As is basis, with all faults.
- E. Purchasers of this part are solely responsible for proper storing, handling, assembly and processing of known good die (KGD) (including, without limitation, proper ESD preventative measures, die preparation, die attach, wire bonding and related assembly and test activities), and Mini-Circuits assumes no responsibility therefor or for environmental effects on KGD.
- F. Mini-Circuits and the Mini-Circuits logo are registered trademarks of Scientific Components Corporation d/b/a Mini-Circuits. All other third-party trademarks are the property of their respective owners. A reference to any third-party trademark does not constitute or imply any endorsement, affiliation, sponsorship, or recommendation by any such third-party of Mini-Circuits or its products.



# Mouser Electronics

Authorized Distributor

Click to View Pricing, Inventory, Delivery & Lifecycle Information:

[Mini-Circuits:](#)

[SMIQ-6243H+](#)