



MMIC SURFACE MOUNT

Wideband Amplifier

PMA3-15453+

50Ω 15 to 45 GHz High Dynamic Range

THE BIG DEAL

- Low Noise Figure, Typ. 3.2 dB
- High OIP3, Typ. +25 dBm
- P1dB, Typ. +17 dBm
- Single +5V positive supply voltage
- 3x3 mm, 12-Lead QFN-Style Package

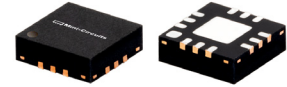

Generic photo used for illustration purposes only

APPLICATIONS

- Test & Measurement Equipment
- 5G mmWave and Back Haul Radio Systems
- Satellite Communications
- Radar, EW, and ECM Defense Systems

FUNCTIONAL DIAGRAM

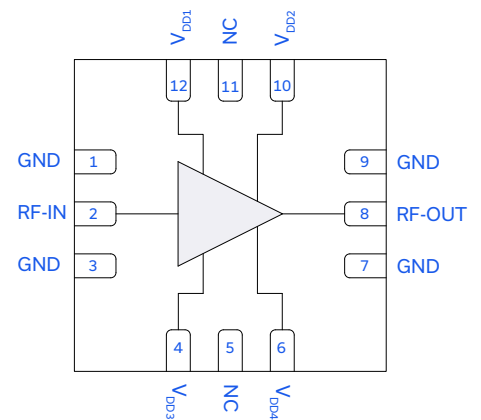

PRODUCT OVERVIEW

The PMA3-15453+ is a pHEMT based wideband, low noise MMIC amplifier with a unique combination of high dynamic range and low noise figure over a very broad bandwidth making it ideal for use in a wide variety of transmitter and receiver applications. This design operates on a single 5V positive supply, is matched to 50 Ohm and comes in a tiny plastic package (3 x 3 x 0.89mm), accommodating dense circuit board layouts.

KEY FEATURES

Feature	Advantages
Low Noise Figure, Typ. 3.2 dB	Enables lower system noise figure performance.
High Dynamic Range <ul style="list-style-type: none"> • OIP3, Typ. +25 dBm • P1dB, Typ. +17 dBm 	Offer low noise figure with correspondingly high P1dB and OIP3 enables flexibility to achieve systems performance with multiple device cascade signal chains
3x3mm 12-lead QFN-Style Package	Small footprint saves space in dense layouts while providing low inductance, repeatable transitions, and excellent thermal contact to the PCB.



MMIC SURFACE MOUNT

Wideband Amplifier

PMA3-15453+

Mini-Circuits

50Ω 15 to 45 GHz High Dynamic Range

ELECTRICAL SPECIFICATIONS¹ AT 25°C, V_S = +5V, UNLESS NOTED OTHERWISE

Parameter	Condition (GHz)	Min.	Typ.	Max.	Units
Frequency Range		15		45	GHz
Gain	15	17.9	18.9		dB
	20	15.9	17.2		
	30	15.0	16.7		
	40	13.1	14.9		
	45	7.2	11.0		
Output Power at 1 dB Compression (P1dB)	15		+13.2		dBm
	20		+13.0		
	30		+17.1		
	40		+15.0		
	45		+12.1		
Output Third-Order Intercept (P _{OUT} = -5 dBm/Tone)	15		+21		dBm
	20		+23		
	30		+25		
	40		+25		
	45		+24		
Input Return Loss	15		20		dB
	20		11		
	30		13		
	40		20		
	45		10		
Output Return Loss	15		12		dB
	20		10		
	30		12		
	40		21		
	45		14		
Isolation	15 - 45		40		dB
Noise Figure	15		2.6		dB
	20		2.8		
	30		3.2		
	40		3.7		
	45		5.2		
Device Operating Voltage (V _S)		+4.75	+5.0	+5.25	V
Device Operating Current (I _S) ²			128		mA
DC Current Variation vs. Temperature ³			-19.23		μA/°C
DC Current Variation vs. Voltage ⁴			0.03		mA/mV

1. Tested in Mini-Circuits Characterization Test/Evaluation Board TB-PMA3-15453+. See Figure 2. Board loss de-embedded to the device.

2. Current at P_{IN} = -25 dBm. Increases to 139 mA at P1dB.

3. ((Current at +85°C - Current at -45°C) / (+130°C))

4. ((Current at +5.25 V mA) - (Current at +4.75V in mA)) / ((+5.25V - +4.75V) * 1000 mA/mV)





MMIC SURFACE MOUNT

Wideband Amplifier

PMA3-15453+

Mini-Circuits

50Ω 15 to 45 GHz High Dynamic Range

TYPICAL PERFORMANCE GRAPHS

GAIN vs. TEMPERATURE,
 $P_{IN} = -25 \text{ dBm}$, $V_S = +5 \text{ V}$

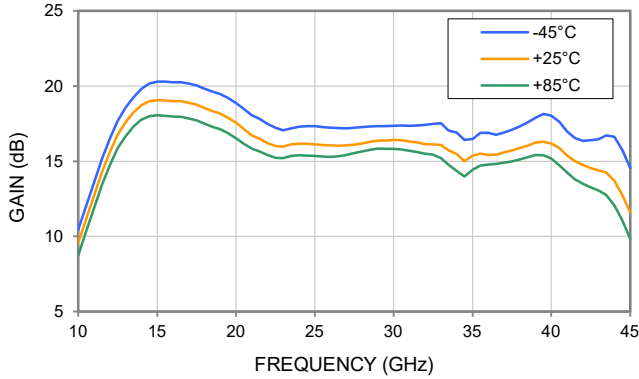

GAIN vs. DEVICE VOLTAGE,
 $P_{IN} = -25 \text{ dBm}$, TEMPERATURE = +25°C

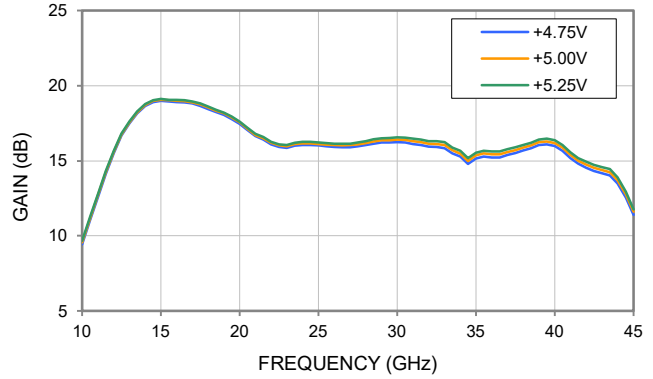

INPUT RETURN LOSS vs. TEMPERATURE,
 $P_{IN} = -25 \text{ dBm}$, $V_S = +5 \text{ V}$

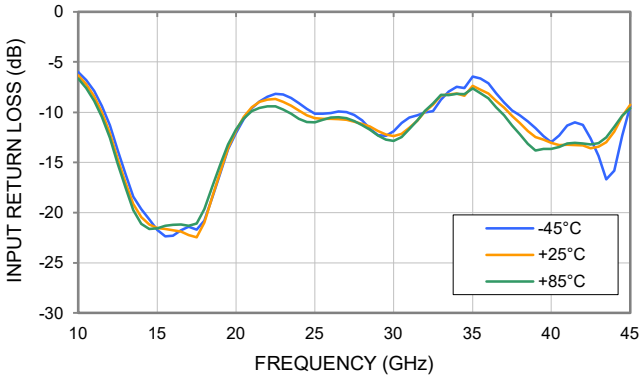

INPUT RETURN LOSS vs. DEVICE VOLTAGE,
 $P_{IN} = -25 \text{ dBm}$, TEMPERATURE = +25°C

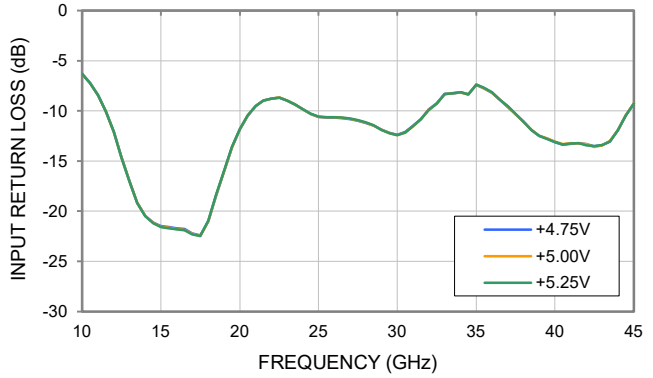

OUTPUT RETURN LOSS vs. TEMPERATURE,
 $P_{IN} = -25 \text{ dBm}$, $V_S = +5 \text{ V}$

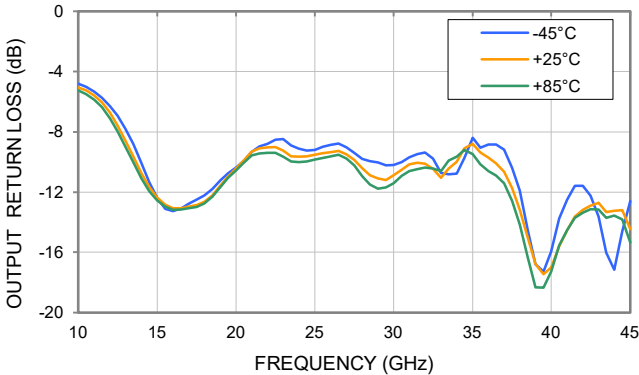

OUTPUT RETURN LOSS vs. DEVICE VOLTAGE,
 $P_{IN} = -25 \text{ dBm}$, TEMPERATURE = +25°C

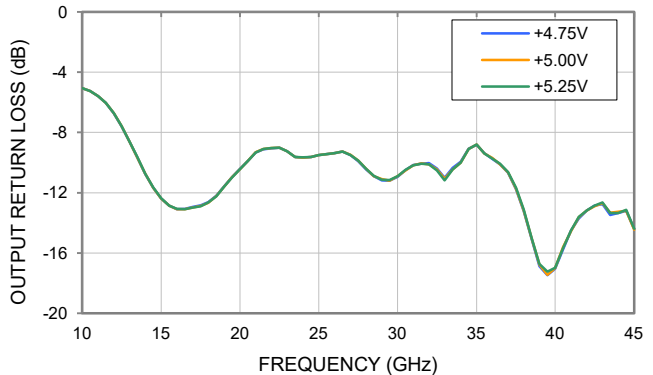



TYPICAL PERFORMANCE GRAPHS

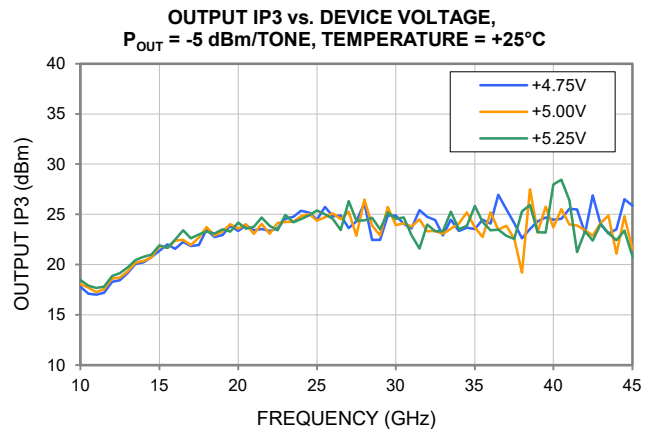
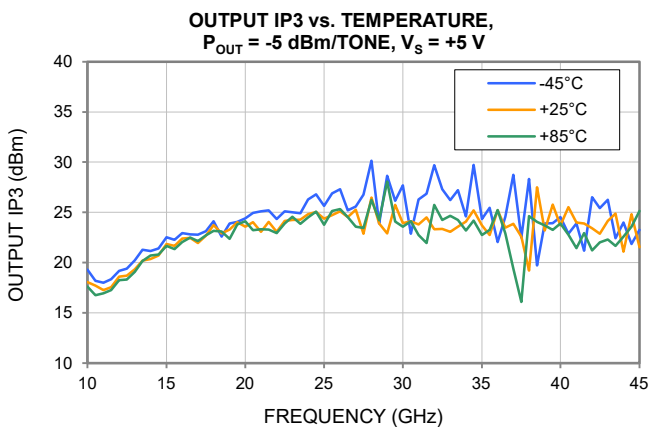
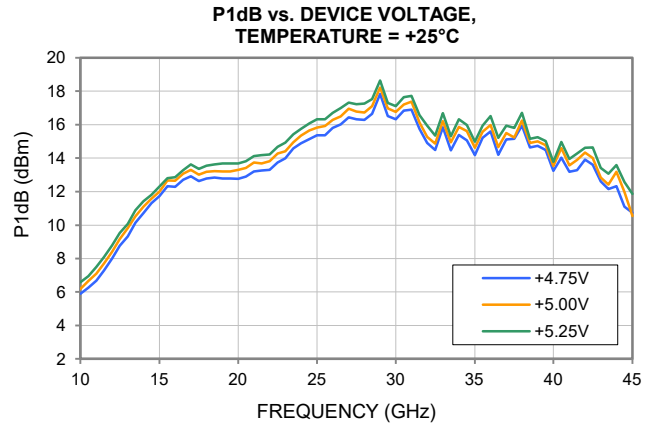
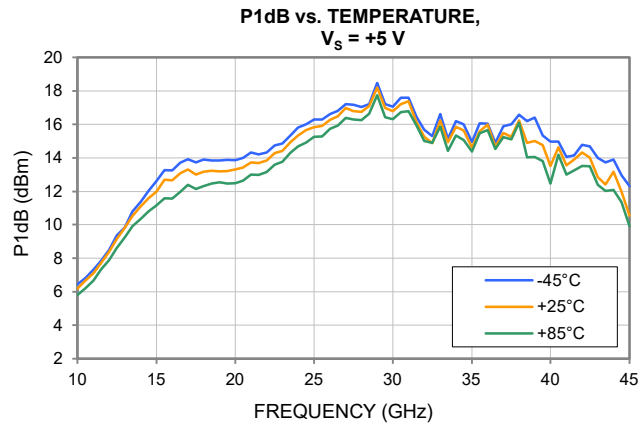
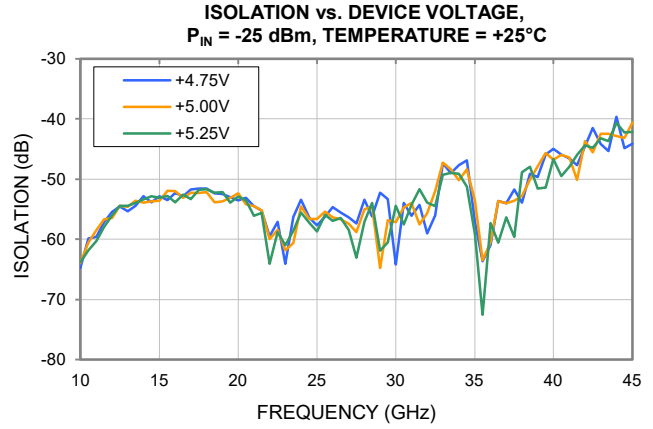
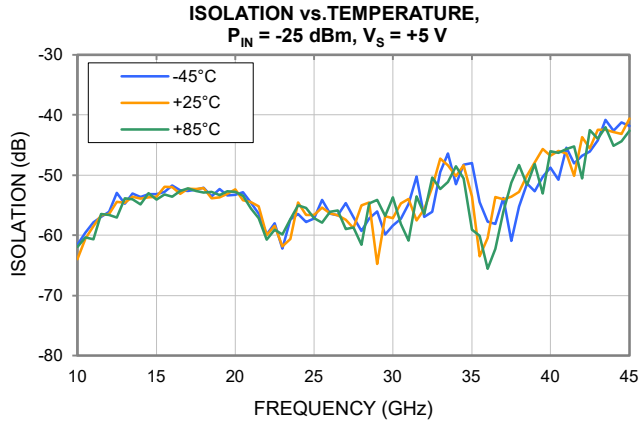



MMIC SURFACE MOUNT

Wideband Amplifier

PMA3-15453+

Mini-Circuits

50Ω 15 to 45 GHz High Dynamic Range

TYPICAL PERFORMANCE GRAPHS

NOISE FIGURE vs. TEMPERATURE,
 $V_S = +5\text{ V}$

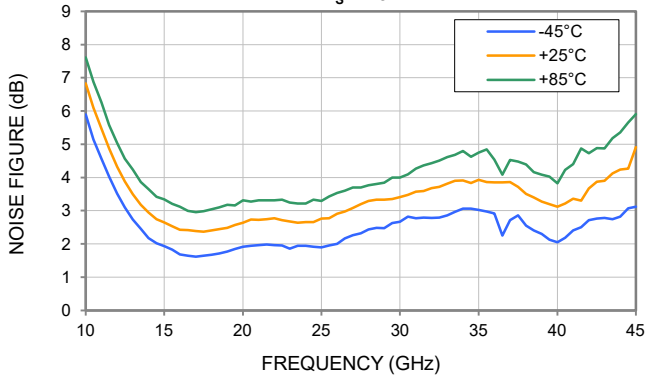

NOISE FIGURE vs. DEVICE VOLTAGE,
TEMPERATURE = +25°C

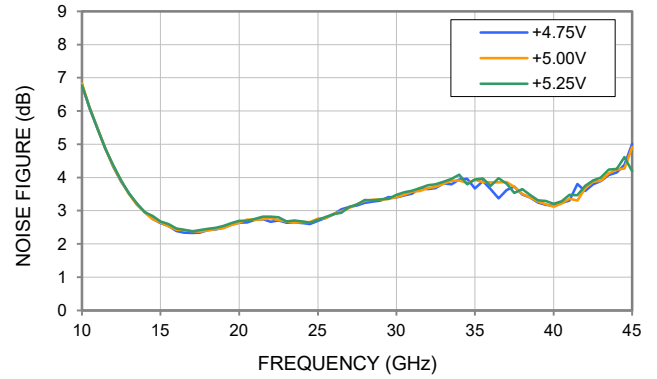

GAIN VARIATION vs. TEMPERATURE,
 $P_{IN} = -25\text{ dBm}$, $V_S = +5\text{ V}$

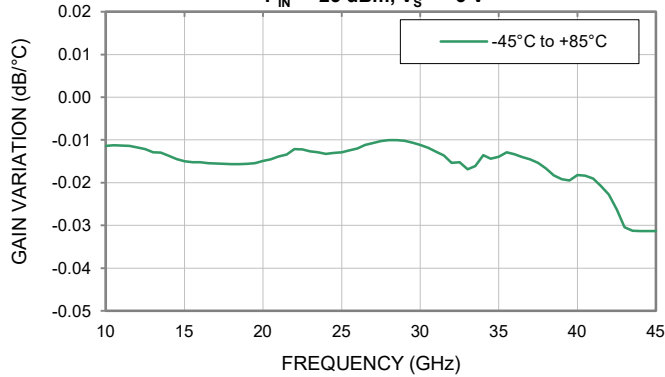



MMIC SURFACE MOUNT

Wideband Amplifier

PMA3-15453+

50Ω 15 to 45 GHz High Dynamic Range

ABSOLUTE MAXIMUM RATINGS⁵

Parameter	Ratings
Operating Temperature	-45 °C to +85 °C
Storage Temperature	-65 °C to +150 °C
Junction Temperature ⁶	+150 °C
Total Power Dissipation	1.62 W
Input Power (CW), $V_S = +5V$	+23 dBm
DC Voltage at V_{DD1} , V_{DD2} , V_{DD3} , V_{DD4}	+10 V

5. Permanent damage may occur if any of these limits are exceeded. Maximum ratings are not intended for continuous normal operation.

6. Peak temperature on top of Die.

THERMAL RESISTANCE

Parameter	Ratings
Thermal Resistance (Θ_{jc}) ⁷	32.2°C/W

7. Θ_{jc} = (Hot Spot Temperature on Die - Temperature at Ground Lead)/Dissipated Power

ESD RATING

	Class	Voltage Range	Reference Standard
Human Body Model (HBM)	1A	250V to <500V	ANSI/ESDA/JEDEC JS-001-2017



ESD HANDLING PRECAUTION: This device is designed to be Class 1A for HBM. Static charges may easily produce potentials higher than this with improper handling and can discharge into DUT and damage it. As a preventive measure Industry standard ESD handling precautions should be used at all times to protect the device from ESD damage.

MSL RATING

Moisture Sensitivity: MSL1 in accordance with IPC/JEDEC J-STD-020E /JEDEC J-STD-033C





FUNCTIONAL DIAGRAM

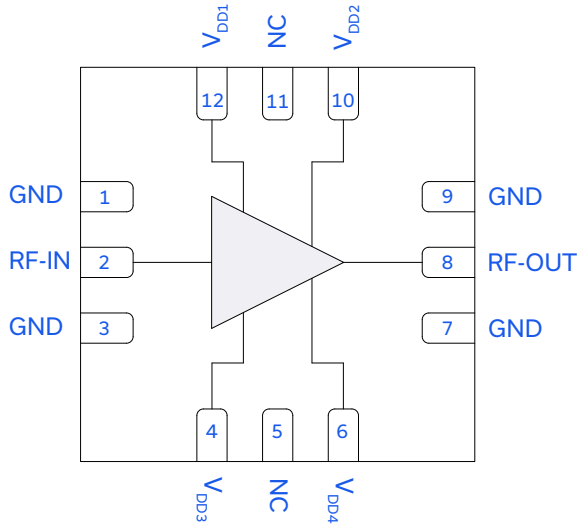

Figure 1. PMA3-15453+ Functional Diagram

PAD DESCRIPTION

Function	Pad Number	Description (Refer to Figure 2)
RF-IN	2	RF-IN Pad connects to RF Input port.
RF-OUT	8	RF-OUT Pad connects to RF Output port.
V _{DD1}	12	DC Input Pad connects to voltage input port V _{DD1}
V _{DD2}	10	DC Input Pad connects to voltage input port V _{DD2}
V _{DD3}	4	DC Input Pad connects to voltage input port V _{DD3}
V _{DD4}	6	DC Input Pad connects to voltage input port V _{DD4}
GND	1, 3, 7, 9	Connects to ground
NC	5, 11	Not used internally. Connected to ground on test board.

CHARACTERIZATION TEST BOARD

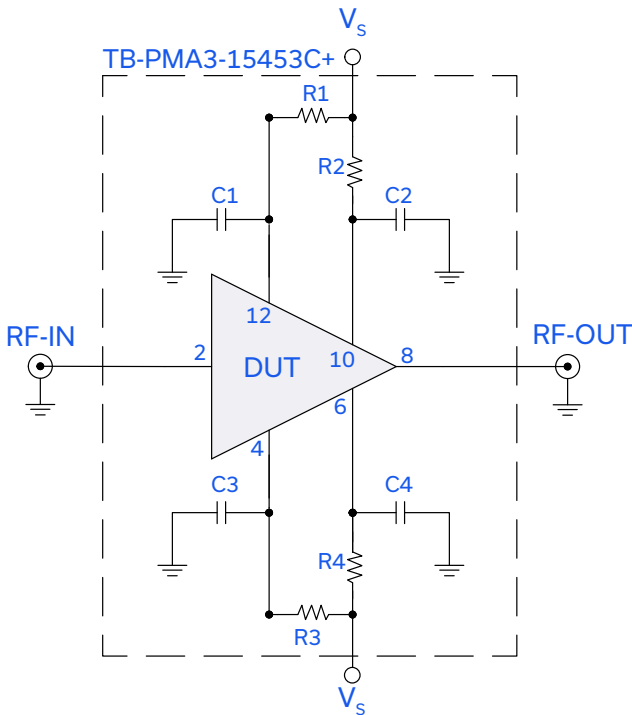

Figure 2. DUT soldered on Mini-Circuits Characterization Test Board: TB-PMA3-15453C+

Gain, Return Loss, Output Power at 1dB Compression (P_{1dB}), Output IP₃ (OIP₃) and Noise Figure measured using N5242A PNA-X microwave network analyzer.

Conditions:

- Gain and Return Loss: P_{IN} = -25 dBm
- Output IP₃ (OIP₃): Two tones, spaced 1 MHz apart, -5 dBm/ tone at output.
- V_s = +5V

Component	Vendor	Vendor P/N	Value	Size
C1, C2, C3, C4	Murata	GRM1555C1H101JA01D	100 pF	0402
R1, R3	KOA	SG73P1JTTD39R0F	39 Ω	0603
R2, R4	KOA	SG73S1JTTD24R0F	24 Ω	0603



CASE STYLE DRAWING

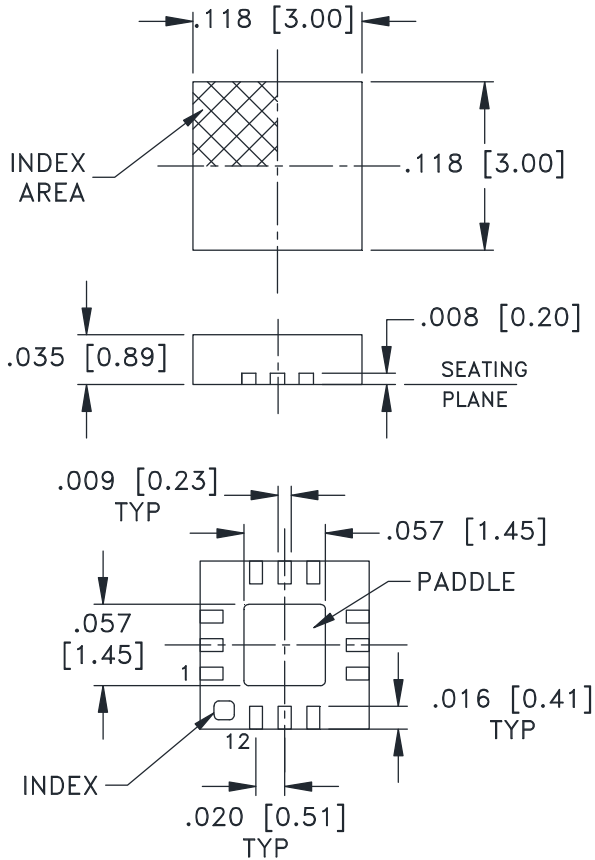

PCB Land Pattern

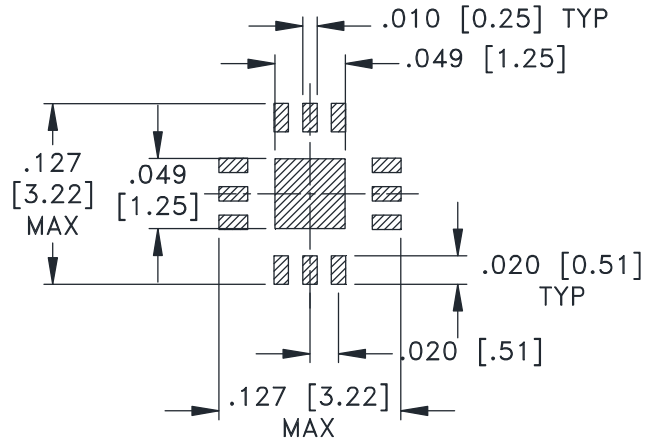

SUGGESTED LAYOUT,
TOLERANCE TO BE WITHIN ±.002

Weight: .02 Grams

Dimensions are in inches [mm].

Figure 3. DQ1225 Case Style Drawing

PRODUCT MARKING



Marking may contain other features or characters for internal lot control

Figure 4. PMA3-15453+ Product Marking



MMIC SURFACE MOUNT

Wideband Amplifier

PMA3-15453+

50Ω 15 to 45 GHz High Dynamic Range

ADDITIONAL DETAILED INFORMATION IS AVAILABLE ON OUR DASH BOARD [CLICK HERE](#)

Performance Data	Data Graphs S-Parameter (S2P Files) Data Set (.zip file)
Case Style	DQ1225 Plastic package, exposed paddle, lead finish: Matte-Tin
RoHs Status	Compliant
Tape & Reel	F66
Standard quantities available on reel	7" reels with 20, 50, 100, 200, 500,1K or 2K devices
Suggested Layout for PCB Design	PL-731
Evaluation Board	TB-PMA3-15453C+ Gerber File
Environmental Ratings	ENV08T1

NOTES

- A. Performance and quality attributes and conditions not expressly stated in this specification document are intended to be excluded and do not form a part of this specification document.
- B. Electrical specifications and performance data contained in this specification document are based on Mini-Circuit's applicable established test performance criteria and measurement instructions.
- C. The parts covered by this specification document are subject to Mini-Circuits standard limited warranty and terms and conditions (collectively, "Standard Terms"); Purchasers of this part are entitled to the rights and benefits contained therein. For a full statement of the standard terms and the exclusive rights and remedies thereunder, please visit Mini-Circuits' website at www.minicircuits.com/terms/viewterm.html



Mouser Electronics

Authorized Distributor

Click to View Pricing, Inventory, Delivery & Lifecycle Information:

[Mini-Circuits:](#)

[PMA3-15453+](#)