

# HLMP-1301, HLMP-1401, HLMP-1503, HLMP-K401, HLMP-K600



T-1 (3-mm) Diffused LED Lamps

## Data Sheet



### Description

This family of T-1 lamps is widely used in general-purpose indicator applications. Diffusants, tints, and optical design are balanced to yield superior light output and wide viewing angles. Several intensity choices are available in each color for increased design flexibility.

### Features

- High intensity
- Choice of four bright colors:
  - High Efficiency Red
  - Orange
  - Yellow
  - High Performance Green
- Popular T-1 diameter package
- Selected minimum intensities
- Wide viewing angle
- General purpose leads
- Reliable and rugged
- Available on tape and reel

### Package Dimensions

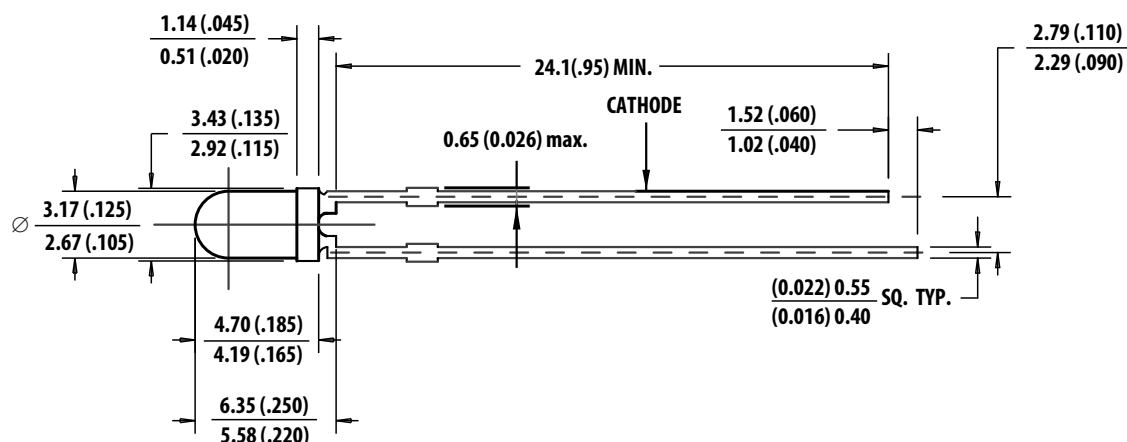

### NOTE

1. All dimensions are in mm (inches).
2. An epoxy meniscus may extend about 1 mm (0.040 in.) down the leads.
3. For PCB hole recommendations, see [Precautions](#).

## Device Selection Guide

Material	Color	Part Number	Luminous Intensity $I_v$ (mcd) at 10 mA	
			Min.	Max.
GaAsP on GaP	Red	HLMP-1301	3.4	—
		HLMP-1301-E00xx	3.4	—
		HLMP-1301-G00xx	8.6	—
		HLMP-1301-GH0xx	8.6	27.6
	Yellow	HLMP-1401	2.2	—
		HLMP-1401-D00xx	3.6	—
		HLMP-1401-E0000	5.7	—
	Orange	HLMP-K401	2.1	—
		HLMP-K401-E00xx	3.4	—
		HLMP-K401-FGDxx	5.4	17.2
		HLMP-K401-FH000	5.4	27.6
	GaP	Green	HLMP-1503	1.0
HLMP-1503-C00xx			2.6	—
HLMP-1503-D00xx			4.2	—
HLMP-1503-DE000			4.2	13.4
HLMP-1503-E00xx			6.7	—
Emerald Green <sup>a</sup>		HLMP-K600	1.0	—

a. Refer to Application Note 1061 for information comparing standard green and emerald green light output degradation.

## Absolute Maximum Ratings at $T_A = 25^\circ\text{C}$

Parameter	HER/Orange	Yellow	Green	Units
Peak Forward Current	90	60	90	mA
Average Forward Current <sup>a</sup>	25	20	25	mA
DC Current <sup>b, c</sup>	30	20	30	mA
Reverse Voltage (IR = 100 A)	5	5	5	V
Transient Forward Current <sup>d</sup> (10s Pulse)	500	500	500	mA
LED Junction Temperature	110	110	110	$^\circ\text{C}$
Operating Temperature Range	-40 to +100	-40 to +100	-20 to +100	$^\circ\text{C}$
Storage Temperature Range	-40 to +100	-40 to +100	-40 to +100	$^\circ\text{C}$

a. See [Figure 5](#) (HER/Orange), [Figure 10](#) (Yellow), or [Figure 15](#) (Green/Emerald Green) to establish pulsed operating conditions.

b. For Red, Orange, and Green series derate linearly from  $50^\circ\text{C}$  at  $0.5\text{ mA}/^\circ\text{C}$ . For Yellow series derate linearly from  $50^\circ\text{C}$  at  $0.2\text{ mA}/^\circ\text{C}$ .

c. For Red, Orange, and Green series derate power linearly from  $25^\circ\text{C}$  at  $1.8\text{ mW}/^\circ\text{C}$ . For Yellow series derate power linearly from  $50^\circ\text{C}$  at  $1.6\text{ mW}/^\circ\text{C}$ .

d. The transient peak current is the maximum non-recurring peak current that can be applied to the device without damaging the LED die and wirebond. It is not recommended that the device be operated at peak currents beyond the peak forward current listed in the Absolute Maximum Ratings.

## Electrical/Optical Characteristics at $T_A = 25^\circ\text{C}$

Parameter	Symbol	Device	Min.	Typ.	Max.	Units	Test Conditions
Included Angle Between Half Luminous Intensity Points	$2\theta_{1/2}$	All	—	60	—	Deg.	$I_F = 10\text{ mA}$ , See Note <sup>a</sup>
Peak Wavelength	$\lambda_{\text{PEAK}}$	High Efficiency Red	—	635	—	nm	Measurement at Peak
		Orange	—	600	—		
		Yellow	—	583	—		
		Green	—	565	—		
		Emerald Green	—	558	—		
Dominant Wavelength	$\lambda_d$	High Efficiency Red	—	626	—	nm	See Note <sup>b</sup>
		Orange	—	602	—		
		Yellow	—	585	—		
		Green	—	569	—		
		Emerald Green	—	560	—		
Spectral Line Halfwidth	$\Delta\lambda_{1/2}$	High Efficiency Red	—	40	—	nm	
		Yellow	—	36	—		
		Green	—	28	—		
		Emerald Green	—	24	—		
Speed of Response	$\tau_s$	High Efficiency Red	—	90	—	ns	
		Orange	—	280	—		
		Yellow	—	90	—		
		Green	—	500	—		
		Emerald Green	—	3100	—		
Capacitance	C	High Efficiency Red	—	11	—	pF	$V_F = 0$ ; $f = 1\text{ MHz}$
		Orange	—	4	—		
		Yellow	—	15	—		
		Green	—	18	—		
		Emerald Green	—	35	—		
Thermal Resistance	$R\theta_{\text{J-PIN}}$	All	—	290	—	$^\circ\text{C/W}$	Junction to Cathode Lead
Forward Voltage	$V_F$	HER/Orange	1.5	1.9	2.4	V	$I_F = 10\text{ mA}$
		Yellow	1.5	2.0	2.4		
		Green	1.5	2.1	2.7		
		Emerald Green	—	2.1	2.7		
Reverse Breakdown Voltage	$V_R$	All	5.0	—	—	V	$I_R = 100\text{ }\mu\text{A}$
Luminous Efficacy	$\eta_V$	High Efficiency Red	—	145	—	lumens/ watt	See Note <sup>c</sup>
		Orange	—	380	—		
		Yellow	—	500	—		
		Green	—	595	—		
		Emerald Green	—	655	—		

- a.  $\theta_{1/2}$  is the off-axis angle at which the luminous intensity is half the axial luminous intensity.
- b. The dominant wavelength,  $\lambda_d$ , is derived from the CIE chromaticity diagram and represents the single wavelength which defines the color of the device.
- c. Radiant intensity,  $I_e$ , in watts/steradian, may be found from the equation  $I_e = I_v/\eta_v$ , where  $I_v$  is the luminous intensity in candelas and  $\eta_v$  is the luminous efficacy in lumens/watt.

## Part Numbering System

H L M P - 

x <sub>1</sub>	x <sub>2</sub>	x <sub>3</sub>	x <sub>4</sub>
----------------	----------------	----------------	----------------

 - 

x <sub>5</sub>	x <sub>6</sub>	x <sub>7</sub>	x <sub>8</sub>	x <sub>9</sub>
----------------	----------------	----------------	----------------	----------------

Code	Description	Option	
x <sub>1</sub>	Package type	1	T-1 (3 mm)
		K	T-1 (3 mm)
x <sub>2</sub>	Color	3	GaP HER
		4	GaP Yellow (except K4xx series)
		5	GaP Green
		6	GaP Emerald Green
x <sub>3</sub> x <sub>4</sub>	Product specific designation	—	
x <sub>5</sub>	Minimum intensity bin	Refer to Intensity Bin Limits Table	
x <sub>6</sub>	Maximum intensity bin		
x <sub>7</sub>	Color bin selection	0	Full range
		D	Color Bin 4 and 5 only
x <sub>8</sub> x <sub>9</sub>	Packaging option	00	Bulk packaging
		02	Tape and Reel, Straight Leads
		A1	Right Angle Housing, Uneven Leads
		A2	Right Angle Housing, Even Leads
		FG	Products need inventory control for customer IDI

## Intensity Bin Limits

**Table 1 Intensity Bin Limits**

Color	Bin	Intensity Range (mcd)	
		Min.	Max.
Red/Orange	D	2.4	3.8
	E	3.8	6.1
	F	6.1	9.7
	G	9.7	15.5
	H	15.5	24.8
	I	24.8	39.6
	J	39.6	63.4
	K	63.4	101.5
	L	101.5	162.4
	M	162.4	234.6
	N	234.6	340.0
	O	340.0	540.0
	P	540.0	850.0
	Q	850.0	1200.0
	R	1200.0	1700.0
	S	1700.0	2400.0
	T	2400.0	3400.0
	U	3400.0	4900.0
	V	4900.0	7100.0
W	7100.0	10200.0	
X	10200.0	14800.0	
Y	14800.0	21400.0	
Z	21400.0	30900.0	

**Table 1 Intensity Bin Limits (Continued)**

Color	Bin	Intensity Range (mcd)	
		Min.	Max.
Yellow	C	2.5	4.0
	D	4.0	6.5
	E	6.5	10.3
	F	10.3	16.6
	G	16.6	26.5
	H	26.5	42.3
	I	42.3	67.7
	J	67.7	108.2
	K	108.2	173.2
	L	173.2	250.0
	M	250.0	360.0
	N	360.0	510.0
	O	510.0	800.0
	P	800.0	1250.0
	Q	1250.0	1800.0
	R	1800.0	2900.0
	S	2900.0	4700.0
	T	4700.0	7200.0
	U	7200.0	11700.0
V	11700.0	18000.0	
W	18000.0	27000.0	

**Table 1 Intensity Bin Limits (Continued)**

Color	Bin	Intensity Range (mcd)	
		Min.	Max.
Green/Emerald Green	A	1.1	1.8
	B	1.8	2.9
	C	2.9	4.7
	D	4.7	7.6
	E	7.6	12.0
	F	12.0	19.1
	G	19.1	30.7
	H	30.7	49.1
	I	49.1	78.5
	J	78.5	125.7
	K	125.7	201.1
	L	201.1	289.0
	M	289.0	417.0
	N	417.0	680.0
	O	680.0	1100.0
	P	1100.0	1800.0
	Q	1800.0	2700.0
	R	2700.0	4300.0
	S	4300.0	6800.0
T	6800.0	10800.0	
U	10800.0	16000.0	
V	16000.0	25000.0	
W	25000.0	40000.0	

**NOTE** Maximum tolerance for each bin limit is  $\pm 18\%$ .

**NOTE** All categories are established for classification of products. Products may not be available in all categories. Contact your local Broadcom representative for further clarification or information.

## Color Categories

Color	Category #	Lambda (nm)	
		Min.	Max.
Emerald Green	9	522.5	555.5
	8	555.5	558.5
	7	558.5	561.5
	6	561.5	564.5
Green	6	561.5	564.5
	5	564.5	567.5
	4	567.5	570.5
	3	570.5	573.5
Yellow	2	573.5	576.5
	1	582.0	584.5
	3	584.5	587.0
	2	587.0	589.5
Orange	4	589.5	592.0
	5	592.0	593.0
	1	597.0	599.5
	2	599.5	602.0
Orange	3	602.0	604.5
	4	604.5	607.5
	5	607.5	610.5
	6	610.5	613.5
	7	613.5	616.5
	8	616.5	619.5

**NOTE** Tolerance for each bin limit is  $\pm 0.5$  nm.

## Packaging Option Matrix

Packaging Option Code	Definition
00	Bulk Packaging, minimum increment, 500 pcs/bag
02	Tape & Reel, straight leads, minimum increment, 1800 pcs/bag
A1	Right Angle Housing, uneven leads, minimum increment, 500 pcs/bag
A2	Right Angle Housing, even leads, minimum increment, 500 pcs/bag
FG	Inventory Control for Customer IDI

Figure 1 Relative Intensity vs. Wavelength

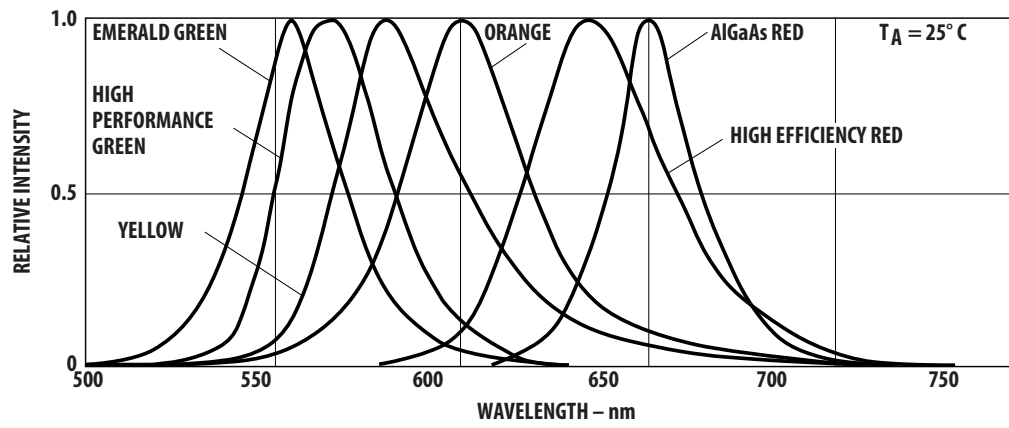

# T-1 High Efficiency Red, Orange Diffused Lamps

Figure 2 Forward Current vs. Forward Voltage Characteristics

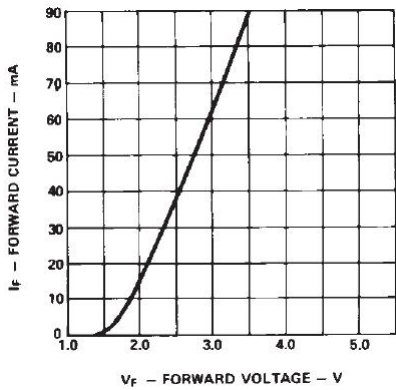

Figure 3 Relative Luminous Intensity vs. DC Forward Current

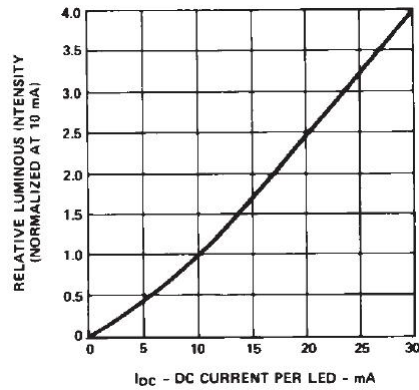

Figure 4 Relative Efficiency (Luminous Intensity per Unit Current) vs. Peak LED Current

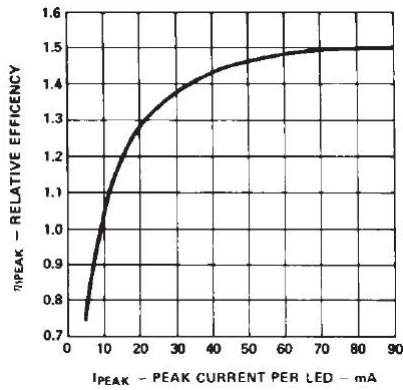

Figure 5 Maximum Tolerable Peak Current vs. Pulse Duration ( $I_{DC}$  MAX as per MAX Ratings)

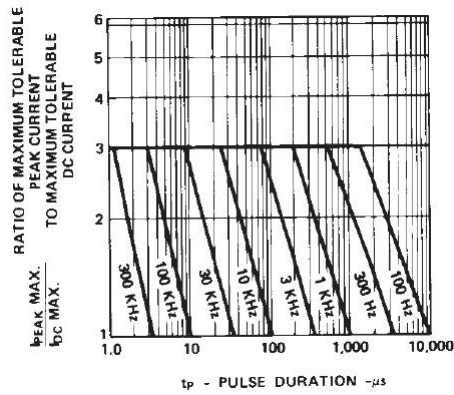
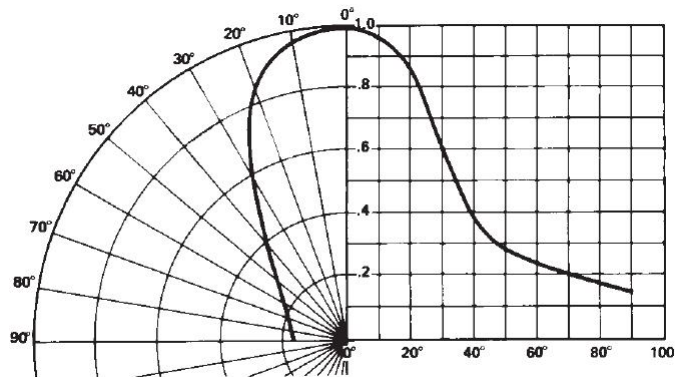

Figure 6 Relative Luminous Intensity vs. Angular Displacement





# T-1 Yellow Diffused Lamps

**Figure 7 Forward Current vs. Forward Voltage Characteristics**

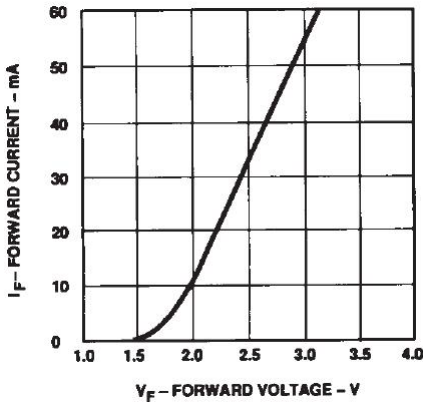

**Figure 8 Relative Luminous Intensity vs. Forward Current**

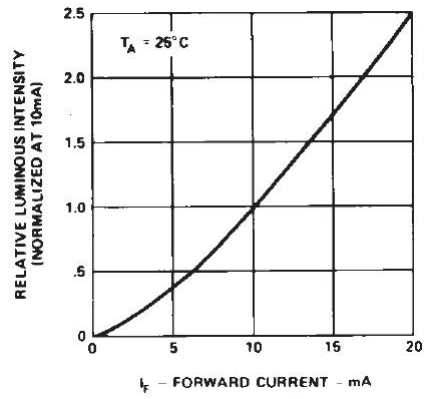

**Figure 9 Relative Efficiency (Luminous Intensity per Unit Current) vs. Peak Current**

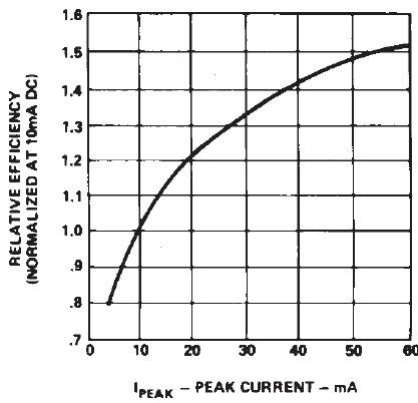

**Figure 10 Maximum Tolerable Peak Current vs. Pulse Duration (I<sub>DC</sub> MAX as per MAX Ratings)**

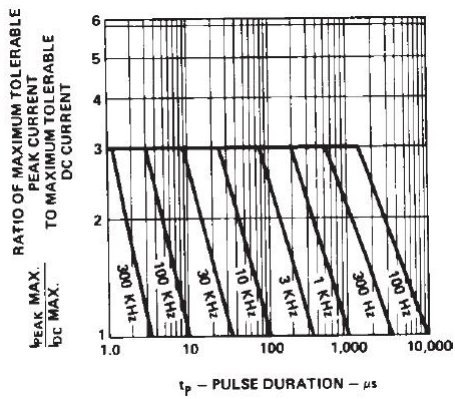

**Figure 11 Relative Luminous Intensity vs. Angular Displacement**

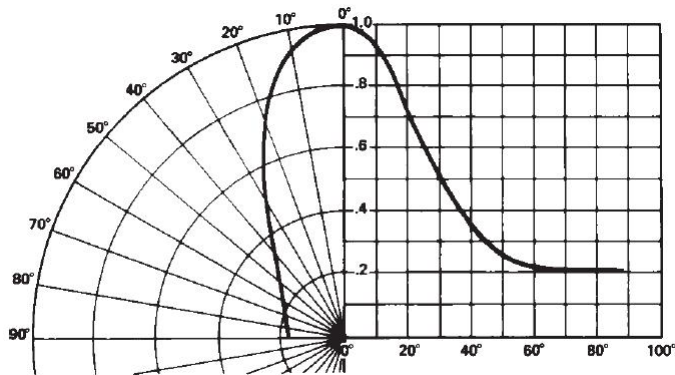

## T-1 Green/Emerald Green Diffused Lamps

Figure 12 Forward Current vs. Forward Voltage Characteristics

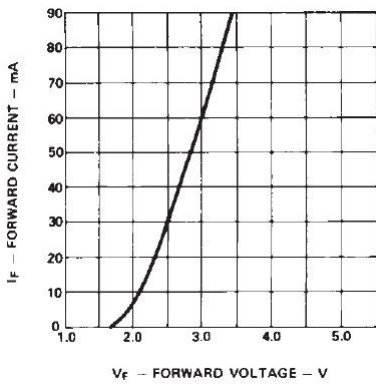

Figure 13 Relative Luminous Intensity vs. Forward Current

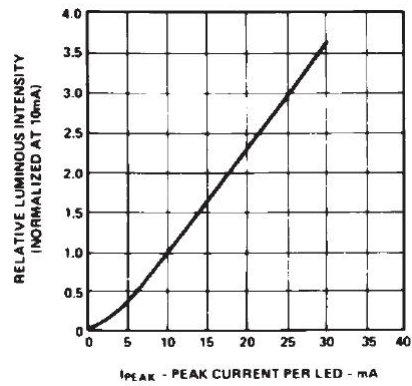

Figure 14 Relative Efficiency (Luminous Intensity per Unit Current) vs. Peak LED Current

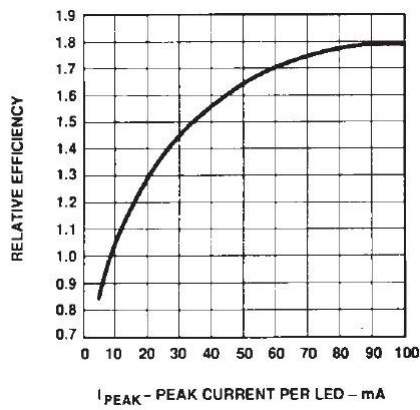

Figure 15 Maximum Tolerable Peak Current vs. Pulse Duration (I<sub>DC</sub> MAX as per MAX Ratings)

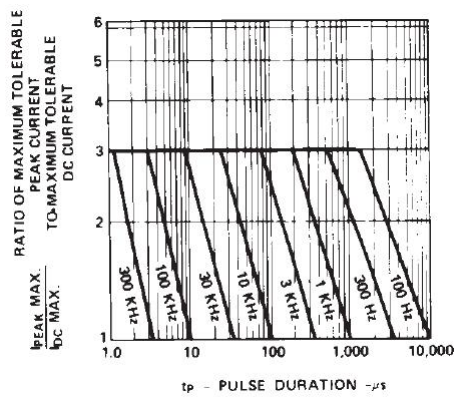
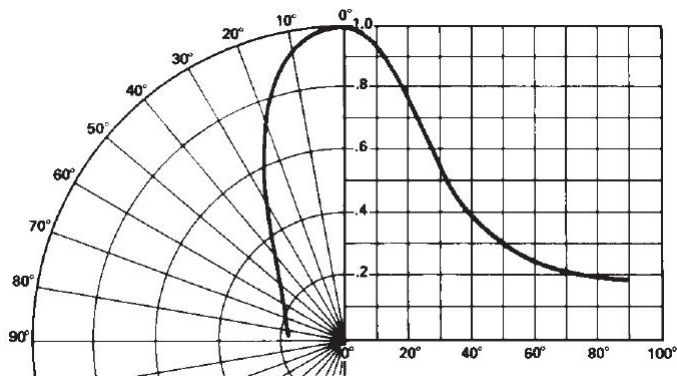

Figure 16 Relative Luminous Intensity vs. Angular Displacement



## Precautions

### Lead Forming

- Preform or cut the leads of an LED lamp to length before they are inserted and soldered into the PC board.
- If forming a lead is required before it is soldered, take care to avoid any excessive mechanical stress induced to the LED package. Otherwise, cut the LED leads to length after soldering at room temperature. The solder joint formed will absorb the mechanical stress of the lead cutting from traveling to the LED chip die attach and wirebond.
- Make tooling precisely and cut the leads cut to length, rather than relying on your hand.

### Soldering Conditions

- Take care during PCB assembly and soldering process to prevent damage to LED component.
- The closest an LED is allowed to be soldered on board is 1.59 mm below the body (encapsulant epoxy) for those parts without standoff.
- Follow the recommended soldering conditions in this table.

	Wave Soldering	Manual Solder Dipping
Pre-heat Temperature	105°C Max.	—
Pre-heat Time	30s Max.	—
Peak Temperature	250°C Max.	260°C Max.
Dwell Time	3s Max.	5s Max.

- Set and maintain the wave soldering parameter according to the recommended temperature and dwell time in the solder wave. You are advised to periodically check the soldering profile to ensure the soldering profile used always conforms to recommended soldering condition.
- If necessary, use a fixture during soldering process to hold the LED component in the proper orientation with respect to the PCB.
- Handle the LED properly to avoid excessive thermal stresses to LED components when heated. Therefore, the soldered PCB must be allowed to cool to room temperature, 25°C, before handling.
- To ensure solderability, pay special attention to board fabrication, solder masking, surface plating, and lead hole size and component orientation.
- Follow the recommended PC board plated through-hole sizes for LED component leads in this table.

	LED Component Lead Size	Diagonal	Plated Through-Hole Diameter
Lead size (typ.)	0.45 × 0.45 mm (0.018 × 0.018 in.)	0.636 mm (0.025 in)	0.98 to 1.08 mm (0.039 to 0.043 in.)
Dambar shear-off area (max.)	0.65 mm (0.026 in.)	0.919 mm (0.036 in)	
Lead size (typ.)	0.50 × 0.50 mm (0.020 × 0.020 in.)	0.707 mm (0.028 in)	1.05 to 1.15 mm (0.041 to 0.045 in.)
Dambar shear-off area (max.)	0.70 mm (0.028 in.)	0.99 mm (0.039 in)	

**NOTE** Refer to application note AN1027 for more information on soldering LED components.

Figure 17 Recommended Wave Soldering Profile

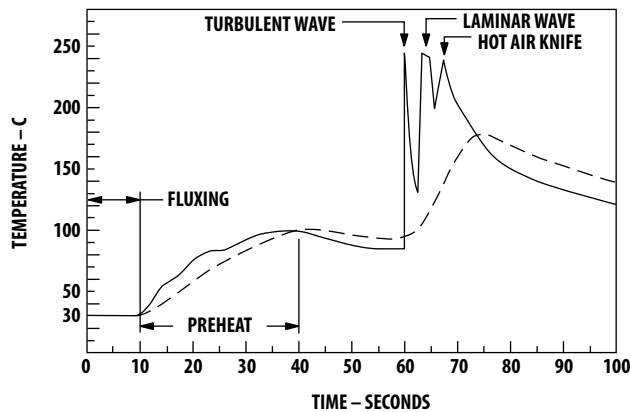

— BOTTOM SIDE OF PC BOARD  
 - - - TOP SIDE OF PC BOARD

CONVEYOR SPEED = 1.83 M/MIN (6 FT/MIN)  
 PREHEAT SETTING = 150C (100C PCB)  
 SOLDER WAVE TEMPERATURE = 245C  
 AIR KNIFE AIR TEMPERATURE = 390C  
 AIR KNIFE DISTANCE = 1.91 mm (0.25 IN.)  
 AIR KNIFE ANGLE = 40  
 SOLDER: SN63; FLUX: RMA

**NOTE: ALLOW FOR BOARDS TO BE SUFFICIENTLY COOLED BEFORE EXERTING MECHANICAL FORCE.**

---

For product information and a complete list of distributors, please go to our web site: [www.broadcom.com](http://www.broadcom.com).

Broadcom, the pulse logo, Connecting everything, Avago Technologies, Avago, and the A logo are among the trademarks of Broadcom and/or its affiliates in the United States, certain other countries and/or the EU.

Copyright © 2013–2017 by Broadcom. All Rights Reserved.

The term "Broadcom" refers to Broadcom Limited and/or its subsidiaries. For more information, please visit [www.broadcom.com](http://www.broadcom.com).

Broadcom reserves the right to make changes without further notice to any products or data herein to improve reliability, function, or design.

Information furnished by Broadcom is believed to be accurate and reliable. However, Broadcom does not assume any liability arising out of the application or use of this information, nor the application or use of any product or circuit described herein, neither does it convey any license under its patent rights nor the rights of others.

AV02-1555EN – July 14, 2017



# Mouser Electronics

Authorized Distributor

Click to View Pricing, Inventory, Delivery & Lifecycle Information:

## Broadcom Limited:

[HLMP-1301](#) [HLMP-1301-E0002](#) [HLMP-1301-E00A1](#) [HLMP-1301-E00A2](#) [HLMP-1301-G0000](#) [HLMP-1301-G0002](#)  
[HLMP-1301-G00A1](#) [HLMP-1301-G00FG](#) [HLMP-1301-GH000](#) [HLMP-1401](#) [HLMP-1401-D0002](#) [HLMP-1401-D00A1](#)  
[HLMP-1401-D00A2](#) [HLMP-1401-E0000](#) [HLMP-1401-E00FG](#) [HLMP-1401-EF000](#) [HLMP-1503](#) [HLMP-1503-C0002](#)  
[HLMP-1503-C00A1](#) [HLMP-1503-C00A2](#) [HLMP-1503-D0000](#) [HLMP-1503-D0002](#) [HLMP-1503-D00FG](#) [HLMP-1503-DE000](#) [HLMP-K401](#) [HLMP-K401-E0002](#) [HLMP-K401-EF000](#) [HLMP-K401-FGD00](#) [HLMP-K600](#)