

D3DC

Miniature Door Switch

7mm long stroke in a small package

- Providing good contact reliability with wiping movement.
- Operating position marks make stroke settings easier.
- Crimp-type connector offers an easy wiring work and efficiency.
- Snap-fit attachment for easy installation.
- Providing two colors, white and black.

RoHS Compliant

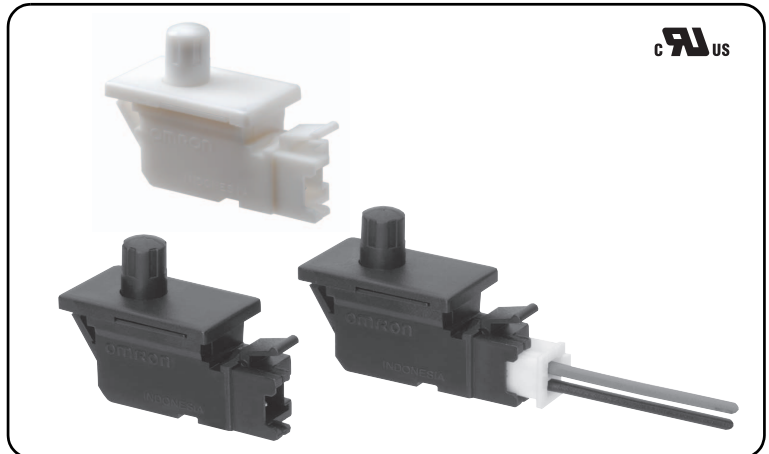

D3DC

Model Number Legend

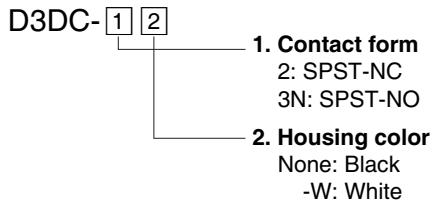

List of Models

Contact form	Housing color	Model
SPST-NC	Black	D3DC-2
	White	D3DC-2-W
SPST-NO	Black	D3DC-3N
	White	D3DC-3N-W

Contact Form

●SPST-NC

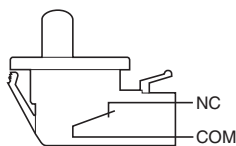

●SPST-NO

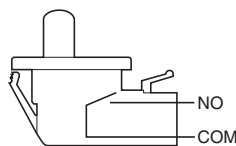

Contact Specifications

Item	Model	D3DC
Contact	Specification	Rivet
	Material	Silver
	Gap (standard value)	0.3 mm
Minimum applicable load (reference value) *		5 VDC 1 mA

* Please refer to the "Using Micro Loads" in "●Precautions" for more information on the minimum applicable load.

Ratings

Rated voltage	Resistive load
30 VDC	0.1 A

Note. The above rating values apply under the following test conditions.

- (1) Ambient temperature: 20±2°C
- (2) Ambient humidity: 65±5%
- (3) Operating frequency: 20 operations/min

Approved Safety Standards

UL (UL1054/CSA C22.2 No.55)

Rated voltage	Model	D3DC
30 VDC		0.1 A

Characteristics

Permissible operating speed		0.5 mm to 1 m/s
Permissible operating frequency	Mechanical	30 operations/min
	Electrical	20 operations/min
Insulation resistance		100 MΩ min. (at 500 VDC with insulation tester)
Contact resistance (initial value)		300 mΩ max.
Dielectric strength	Between terminals of the same polarity	600 VAC 50/60 Hz 1 min
	Between current-carrying metal parts and ground	1,500 VAC 50/60 Hz 1 min
Vibration resistance *1	Malfunction	10 to 55Hz, 1.5 mm double amplitude
Shock resistance	Durability	500 m/s ² {approx. 50G} max.
	Malfunction *1	100 m/s ² {approx. 10G} max.
Durability *2	Mechanical	100,000 operations min. (30 operations/min)
	Electrical	100,000 operations min. (20 operations/min)
Degree of protection		IEC IP00
Ambient operating temperature		-25°C to +85°C (at ambient humidity of 60% max.) (with no icing or condensation)
Ambient operating humidity		85% max. (for +5°C to +35°C)
Weight		Approx. 2g

Note. The data given above are initial values.

*1. The given values apply for Free Position and Total Travel Position. Close or open circuit of the contact is 1 ms max.

*2. For testing conditions, consult your OMRON sales representative.

Mounting Holes (Unit: mm)

Mounting plate thickness: 0.75 to 1.50 mm

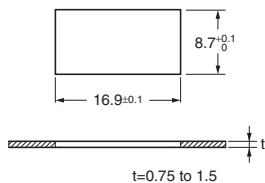

Dimensions (Unit: mm) and Operating Characteristics

The illustrations are for models with black housing as a representative. The □ is replaced with the code for the housing color that you need. See the "List of Models" for available combinations of models.

D3DC-2□
D3DC-3N□

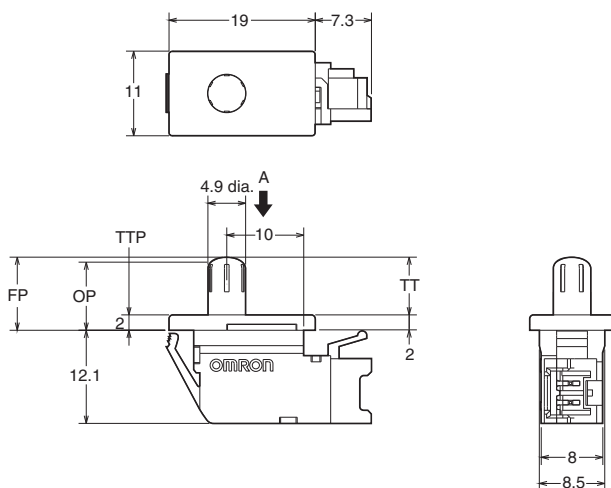

Operating Characteristics		Model	D3DC-2□ D3DC-3N□
Operating Force	OF Max.		1.0 N {102 gf}
Total Travel	TT		7.0 mm (reference value)
Free Position	FP		9.5 mm (reference value)
Operating Position	OP Min.		6.7 mm
Total Travel Position	TTP		2.0 mm (reference value)

Note 1. Unless otherwise specified, a tolerance of ±0.4 mm applies to all dimensions.

Note 2. The operating characteristics are for operation in direction A (↓).

Precautions

★Please refer to "Common Precautions" for correct use.

Cautions

●Handling

- In order to ensure stable contact force for contacts, actuate beyond the recommended operating point (NO contact) and release to free position (NC contact).
- Do not expose the switch to shocks, such as by dropping it. Doing so may damage or deform the switch.
- Do not apply lubrication to the sliding parts. Doing so may result in faulty operation or contact failure.

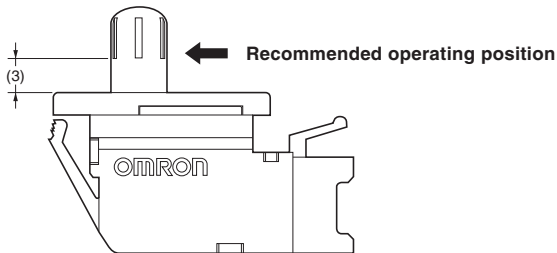

Correct Use

●Mounting

- This product does not have a waterproof or drip-proof construction. Ensure that water does not enter the switch interior.
- In particular, do not use the switch in locations where water may be spilled or flow over the switch. Doing so may result in deterioration of the Switch.
- Also, if the contact is kept open for long period of time, it is recommended to use the Sealed Switch to prevent sulfuration of the Contact.
- Pay attention to the creepage distance/clearance distance for insulation after wiring onto terminal when a mounting frame is made of metal.

Connector

- The terminals connect to JST's XA Connector.
Contact: SXA-001T-P0.6
Housing: XAP-02V-1
- OMRON does not sell the XA Connector.
- Contact JST Mfg. for more information on the connectors.

●Wiring

- Do not use the Switch with Connector mounted and weight load applied to the Connector and lead wire, otherwise it may rattle or may result in connection failure.

●Using Micro Loads

- Even when using micro load models within the operating range shown below, if inrush/surge current occurs, it may increase the contact wear and so decrease durability. Therefore, insert a contact protection circuit where necessary.
- The L-level reference value applies for the minimum applicable load.
- This value indicates the malfunction reference level for the reliability level of 60% (λ_{60}). (JIS C5003)
- The equation, $\lambda_{60}=5 \times 10^{-6}$ /operations indicates that the estimated malfunction rate is less than $\frac{1}{2,000,000}$ operations with a reliability level of 60%.

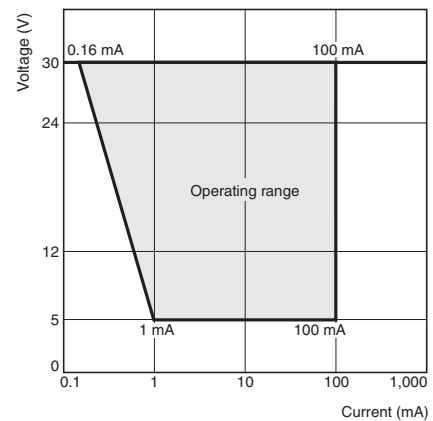

J.S.T. Manufacturing Co.,Ltd.

http://www.jst-mfg.com/index_e.php

• Application examples provided in this document are for reference only. In actual applications, confirm equipment functions and safety before using the product.
• Consult your OMRON representative before using the product under conditions which are not described in the manual or applying the product to nuclear control systems, railroad systems, aviation systems, vehicles, combustion systems, medical equipment, amusement machines, safety equipment, and other systems or equipment that may have a serious influence on lives and property if used improperly. Make sure that the ratings and performance characteristics of the product provide a margin of safety for the system or equipment, and be sure to provide the system or equipment with double safety mechanisms.

Note: Do not use this document to operate the Unit.

Mouser Electronics

Authorized Distributor

Click to View Pricing, Inventory, Delivery & Lifecycle Information:

[Omron:](#)

[D3DC-2](#) [D3DC-3](#) [D3DC-3N](#) [D3DC-2-W](#) [D3DC-3N-W](#)