

Power Schottky Rectifier

Datasheet - production data

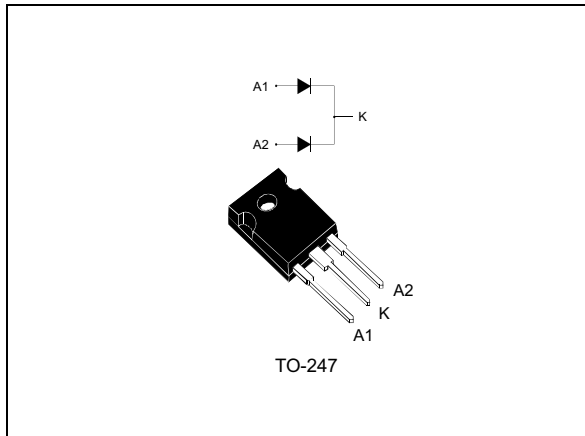

Description

Dual center tap Schottky rectifier suited for switch mode power supply and high frequency DC to DC converters. Packaged in TO-247, this device is intended for use in low voltage, high frequency inverters, free wheeling and polarity protection applications.

Table 1. Device summary

Symbol	Value
$I_F(AV)$	2 x 30 A
V_{RRM}	45 V
$T_j(max.)$	175 °C
$V_F(max.)$	0.63 V

Features

- Very small conduction losses
- Negligible switching losses
- Extreme fast switching
- Low thermal resistance
- Avalanche capability specified

Characteristics

Table 2. Absolute ratings (limiting values, per diode)

Symbol	Parameter		Value	Unit
V _{RRM}	Repetitive peak reverse voltage		45	V
I _{F(RMS)}	RMS forward current		60	A
I _{F(AV)}	Average forward current δ = 0.5	T _c = 150 °C per diode	30	A
I _{FSM}	Surge non repetitive forward current	t _p = 10 ms sinusoidal	400	A
I _{RRM}	Repetive peak reverse current	t _p = 2 μs square F = 1 kHz	1	A
I _{RSM}	Non repetitive peak reverse current	t _p = 100 μs square	3	A
P _{ARM}	Repetitive peak avalanche power	t _p = 1 μs T _j = 25 °C	10600	W
T _{stg}	Storage temperature range		- 65 to + 175	°C
T _j	Maximum operating junction temperature ⁽¹⁾		175	°C
dV/dt	Critical rate of rise or reverse voltage		10000	V/μs

1. $\frac{dP_{tot}}{dT_j} < \frac{1}{R_{th(j-a)}}$ condition to avoid thermal runaway for a diode on its own heatsink

Table 3. thermal resistances

Symbol	Parameter		Value	Unit
R _{th(j-c)}	Junction to case	Per diode	0.95	°C/W
		Total	0.55	
R _{th(c)}		Coupling	0.15	

When the diodes 1 and 2 are simultaneously:

$$\Delta T_j(\text{diode 1}) = P(\text{diode1}) \times R_{th(j-c)} (\text{Per diode}) + P(\text{diode 2}) \times R_{th(c)}$$

Table 4. Static electrical characteristics (per diode)

Symbol	Parameter	Test conditions		Min.	Typ.	Max.	Unit
$I_R^{(1)}$	Reverse leakage current	$T_j = 25\text{ }^\circ\text{C}$	$V_R = V_{RRM}$	-		500	μA
		$T_j = 125\text{ }^\circ\text{C}$		-	20	80	mA
$V_F^{(1)}$	Forward voltage drop	$T_j = 125\text{ }^\circ\text{C}$	$I_F = 30\text{ A}$	-	0.53	0.63	V
		$T_j = 25\text{ }^\circ\text{C}$	$I_F = 60\text{ A}$	-		0.84	
		$T_j = 125\text{ }^\circ\text{C}$	$I_F = 60\text{ A}$	-	0.68	0.78	

1. Pulse test: $t_p = 380\text{ }\mu\text{s}$, $\delta < 2\%$

To evaluate the conduction losses use the following equation:

$$P + 0.48 \times I_{F(AV)} + 0.005 I_{F(RMS)}^2$$

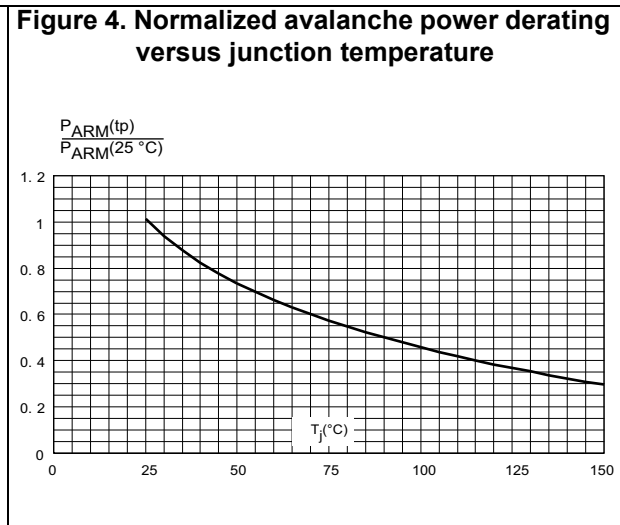
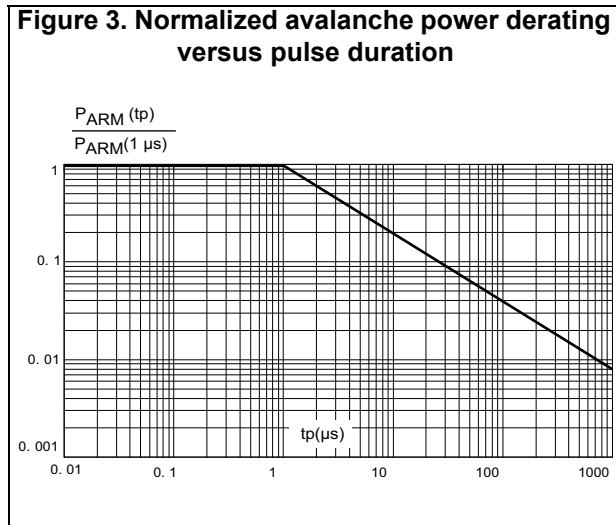
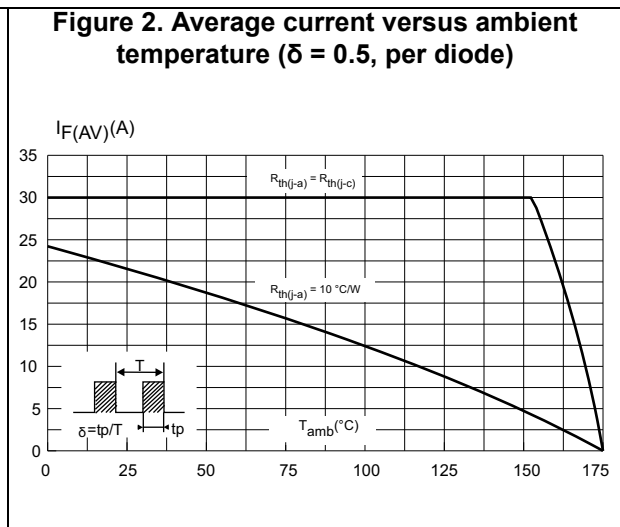
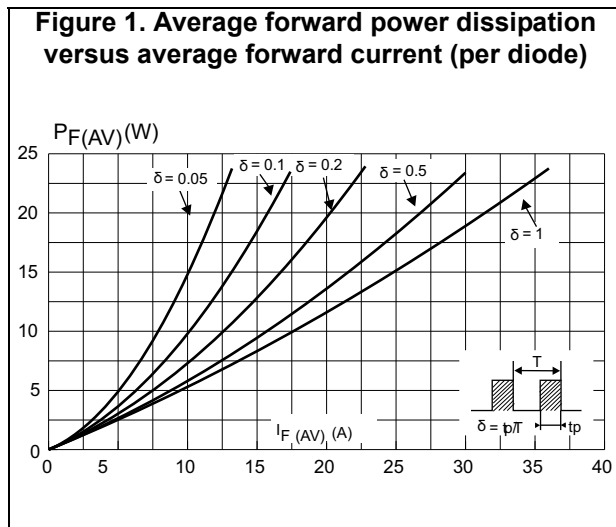

Figure 5. Non-repetitive surge peak forward current versus overload duration (maximum values, per diode)

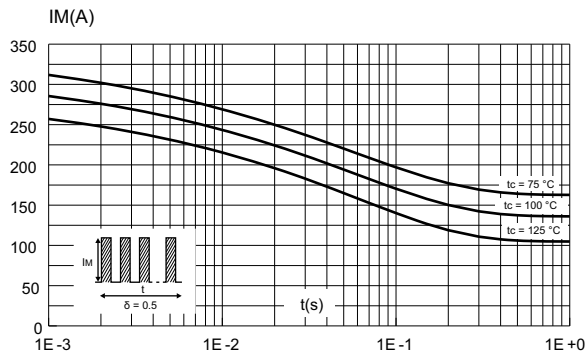

Figure 6. Relative variation of thermal transient impedance junction to case versus pulse duration

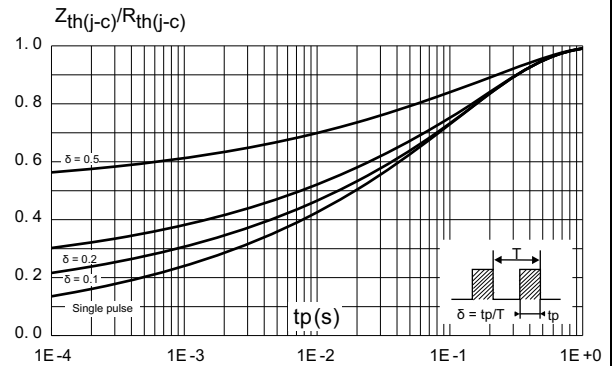

Figure 7. Reverse leakage current versus reverse voltage applied (typical values, per diode)

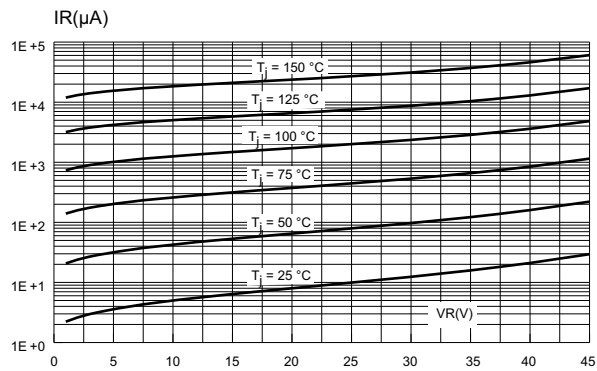
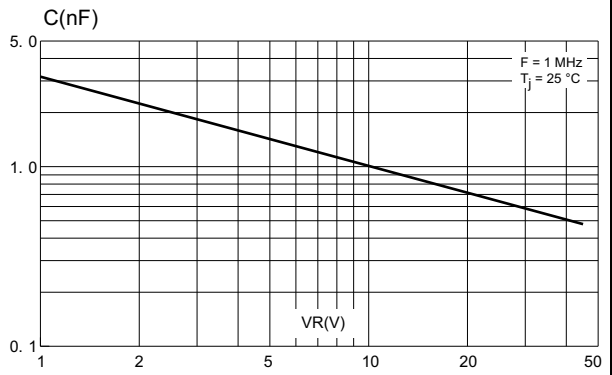
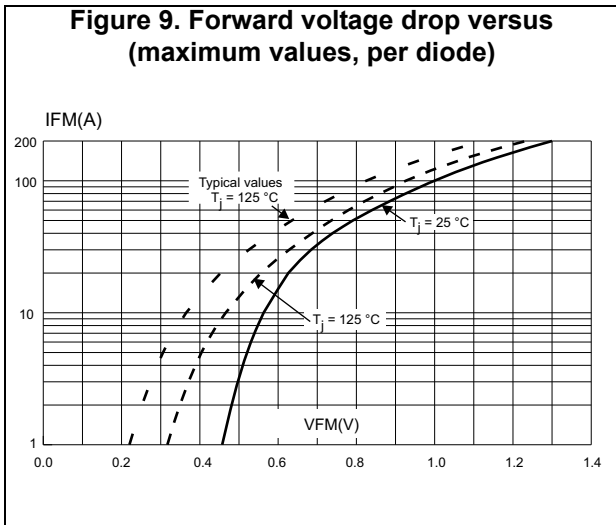

Figure 8. Junction capacitance versus reverse voltage applied (typical values, per diode)





1 Package information

- Cooling method: by conduction (C)
- Recommended torque value: 0.8 N.m.
- Maximum torque value: 1.0 N.m.
- Epoxy meets UL94, V0

In order to meet environmental requirements, ST offers these devices in different grades of ECOPACK® packages, depending on their level of environmental compliance. ECOPACK® specifications, grade definitions and product status are available at: www.st.com. ECOPACK® is an ST trademark.

1.1 TO-247 package information

Figure 10. TO-247 package outline

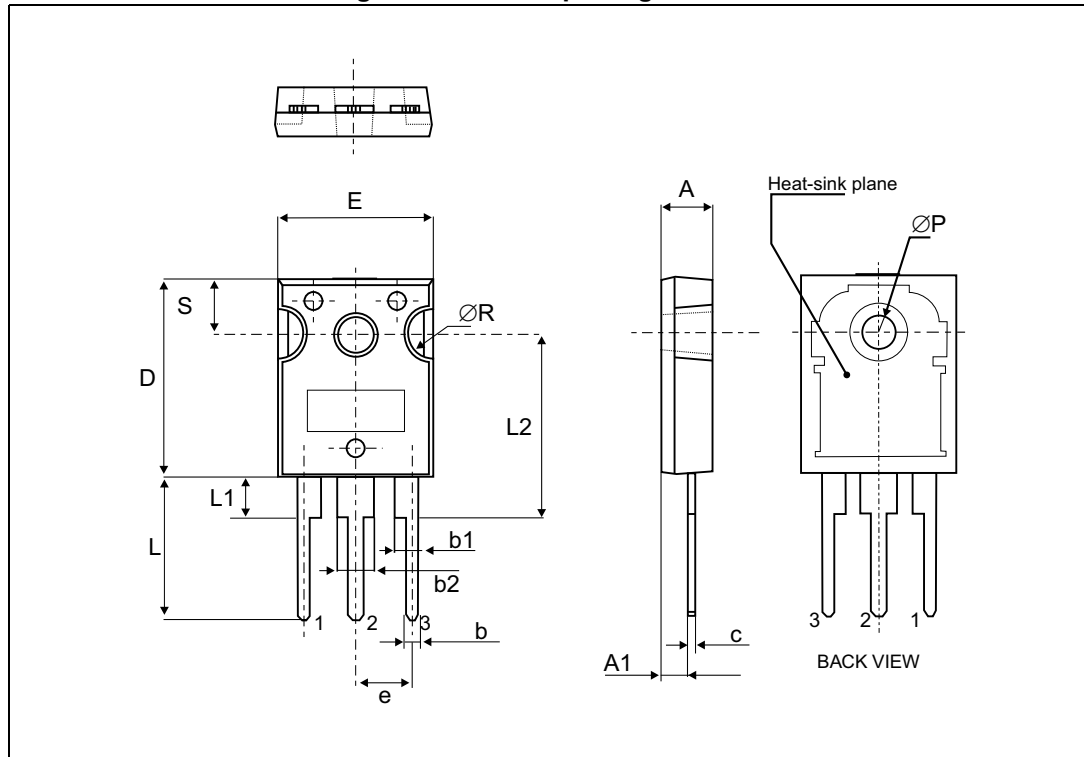

Table 5. TO-247 package mechanical data

Ref.	Dimensions					
	Millimeters			Inches ⁽¹⁾		
	Typ.	Min.	Max.	Typ.	Min.	Max.
A		4.85	5.15		0.191	0.203
A1		2.20	2.60		0.086	0.102
b		1.0	1.40		0.039	0.055
b1		2.0	2.40		0.078	0.094
b2		3.0	3.40		0.118	0.133
c		0.40	0.80		0.015	0.031
D		19.85	20.15		0.781	0.793
E		15.45	15.75		0.608	0.620
e	5.50	5.30	5.60		0.209	0.220
L		14.20	14.80		0.559	0.582
L1		3.70	4.30		0.145	0.169
L2	18.50			0.728		
ØP		3.55	3.65		0.139	0.143
ØR		4.50	5.50		0.177	0.217
S	5.50	5.30	5.70		0.209	0.224

1. Values in inches are converted from mm and rounded to 4 decimal digits.

2 Ordering information

Table 6. Ordering information

Type	Marking	Package	Weight	Base qty.	Delivery mode
STPS6045CW	STPS6045CW	TO-247	4.36 g.	30	Tube

3 Revision history

Table 7. Document revision history

Date	Revision	Changes
24-Jul-2012	7	
11-Dec-2015	8	Format updated to current standard. Update of Table 2 and Table 3 and Table 5 . Update of Figure 2 . Remove of figure 5.2.

IMPORTANT NOTICE – PLEASE READ CAREFULLY

STMicroelectronics NV and its subsidiaries ("ST") reserve the right to make changes, corrections, enhancements, modifications, and improvements to ST products and/or to this document at any time without notice. Purchasers should obtain the latest relevant information on ST products before placing orders. ST products are sold pursuant to ST's terms and conditions of sale in place at the time of order acknowledgement.

Purchasers are solely responsible for the choice, selection, and use of ST products and ST assumes no liability for application assistance or the design of Purchasers' products.

No license, express or implied, to any intellectual property right is granted by ST herein.

Resale of ST products with provisions different from the information set forth herein shall void any warranty granted by ST for such product.

ST and the ST logo are trademarks of ST. All other product or service names are the property of their respective owners.

Information in this document supersedes and replaces information previously supplied in any prior versions of this document.

© 2015 STMicroelectronics – All rights reserved

Mouser Electronics

Authorized Distributor

Click to View Pricing, Inventory, Delivery & Lifecycle Information:

[STMicroelectronics:](#)

[STPS6045CW](#)