

Features

- * 1800W peak pulse power (8/20 μ s)
- * Low leakage: nA level
- * Low operating voltage: 12V
- * Ultra low clamping voltage
- * One power line protects
- * Complies with following standards:
 - IEC 61000-4-2 (ESD) immunity test
 - Air discharge: ± 30 kV
 - Contact discharge: ± 30 kV
 - IEC61000-4-5 (Lightning) 76A (8/20 μ s)
- * RoHS Compliant

Mechanical Characteristics

- * Package: DFN1610-2
- * Ultra low leakage: nA level
- * Case Material: "Green" Molding Compound.
- * UL Flammability Classification Rating 94V-0
- * Moisture Sensitivity: Level 3 per J-STD-020
- * Shipping Qty :3000/7Inch Tape & Reel

Applications

- * Power Management
- * Industrial Application
- * Power Supply Protection
- * Many other portable devices

Dimensions and Pin Configuration

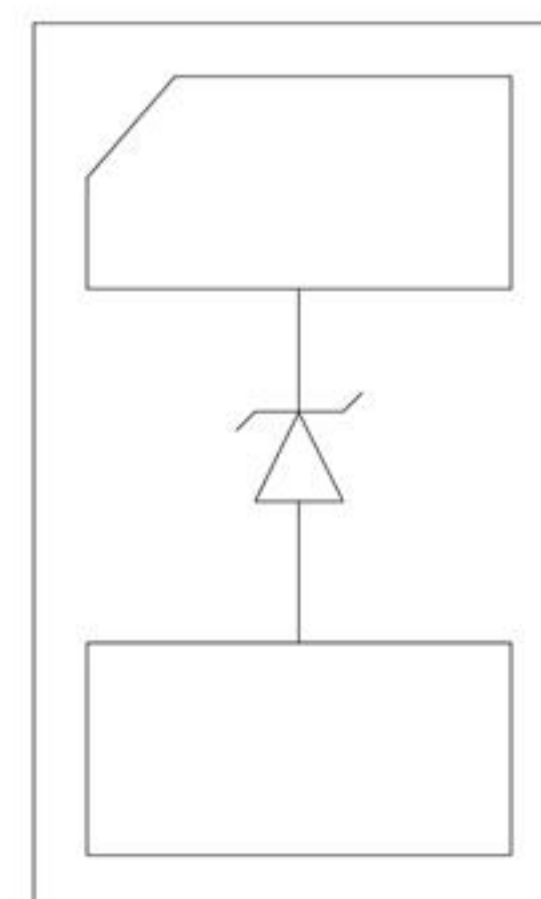
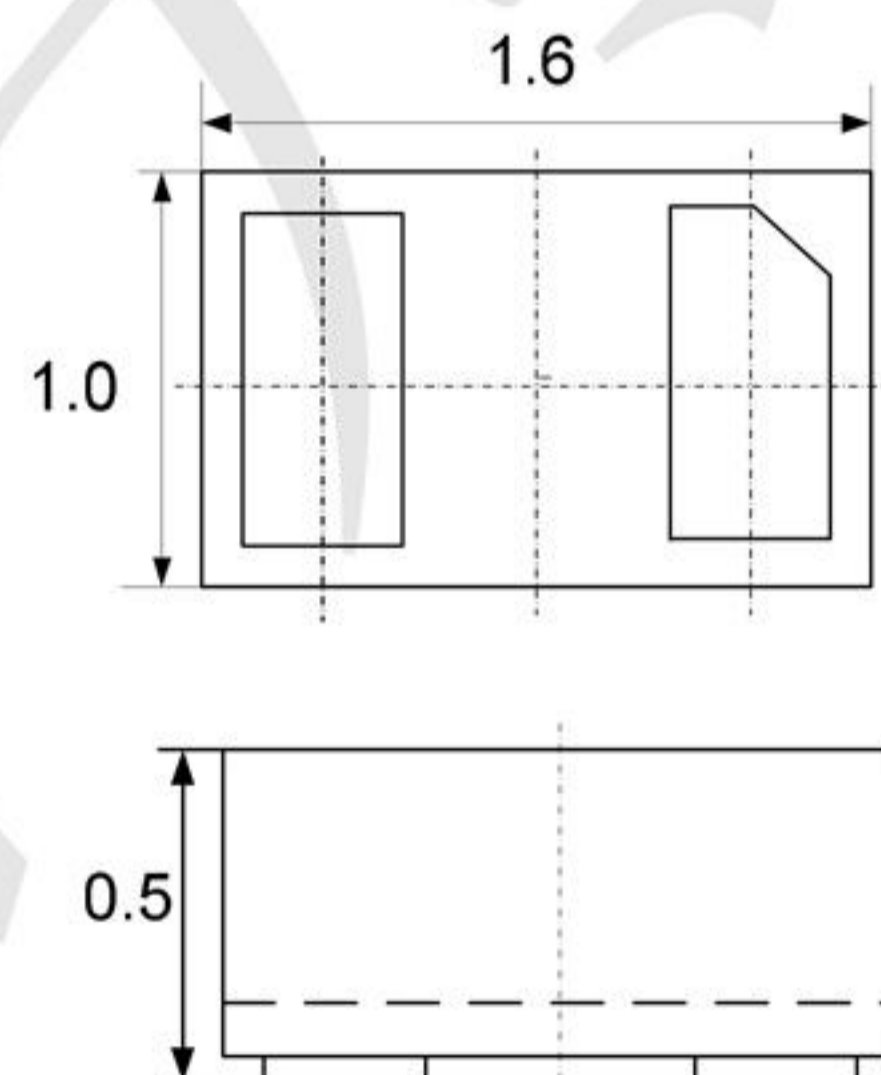

Marking: (72 Or 12P)

Absolute Maximum Ratings (Tamb=25°C unless otherwise specified)

Parameter	Symbol	Value	Unit
Peak Pulse Power (8/20μs)	Ppk	1800	W
Peak Pulse Current (8/20μs)	Ipp	76	A
ESD per IEC 61000-4-2 (Air)	VESD	±30	kV
ESD per IEC 61000-4-2 (Contact)		±30	
Operating Temperature Range	TJ	-55 to +125	°C
Storage Temperature Range	Tstg	-55 to +150	°C

Electrical Characteristics (TA=25°C unless otherwise specified)

Parameter	Symbol	Min	Typ	Max	Unit	Test Condition
Reverse Working Voltage	VRWM			12	V	
Breakdown Voltage	VBR	13	15		V	IT = 1mA
Reverse Leakage Current	IR			0.5	uA	VRWM = 12V
Clamping Voltage	VC		21		V	Ipp=50A(8x 20us pulse)
Clamping Voltage	VC		25		V	Ipp=76A(8x 20us pulse)
Junction Capacitance	CJ			550	pF	VR = 0V, f = 1MHz

Typical Performance Characteristics ($T_A=25^\circ\text{C}$ unless otherwise Specified)

Fig1. 8/20 μs Pulse Waveform

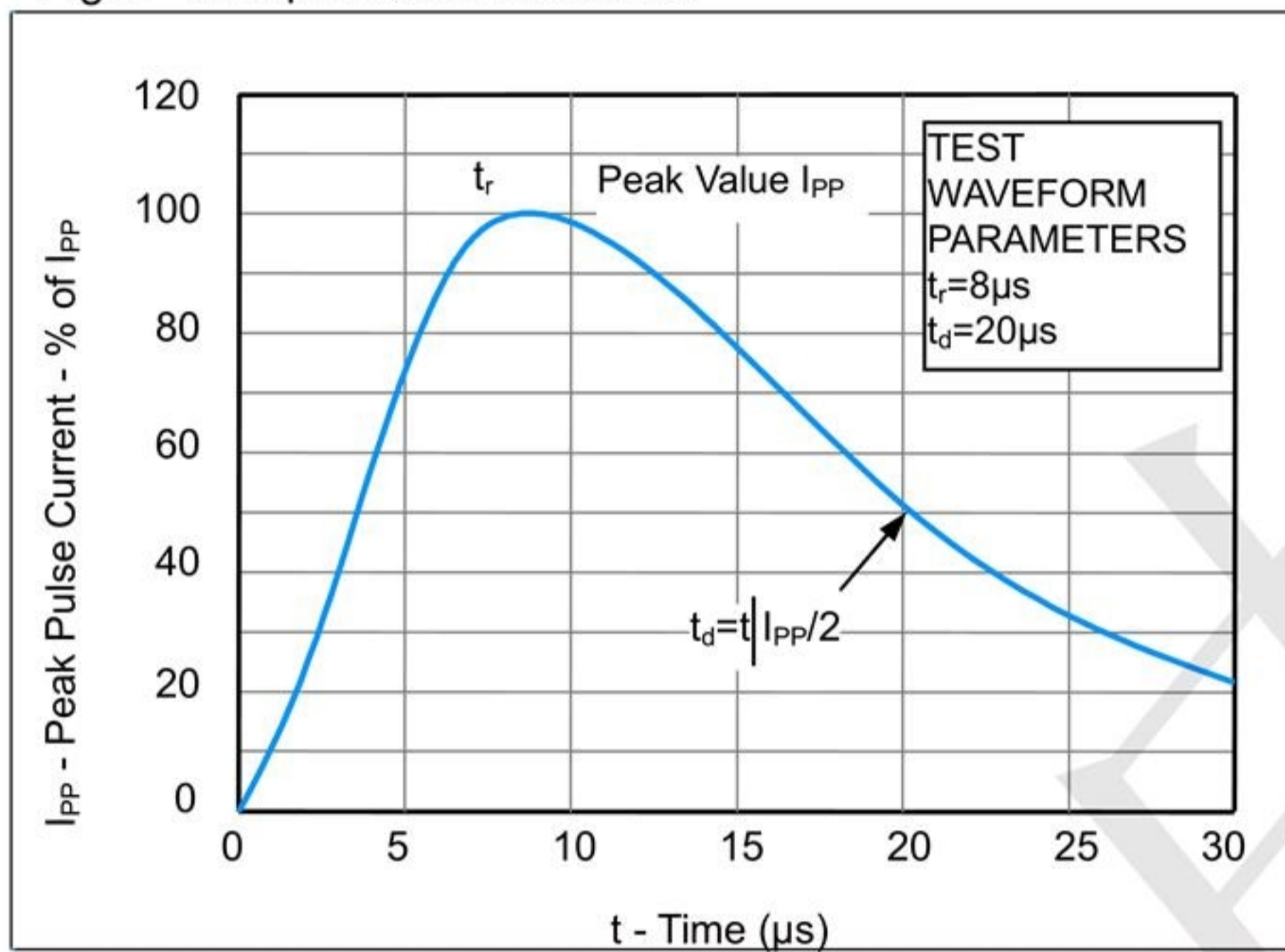

Fig2. ESD Pulse Waveform (according to IEC 61000-4-2)

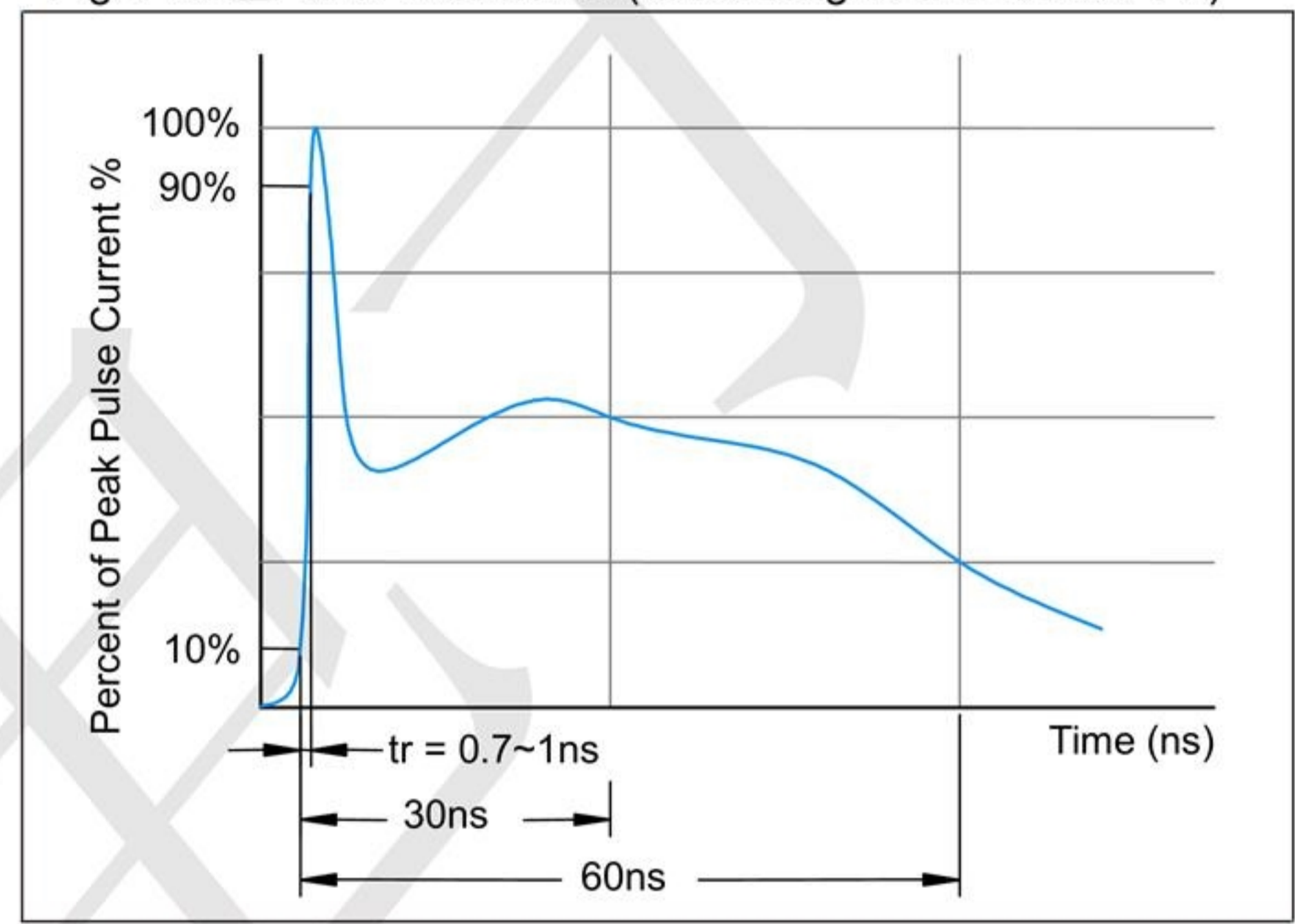
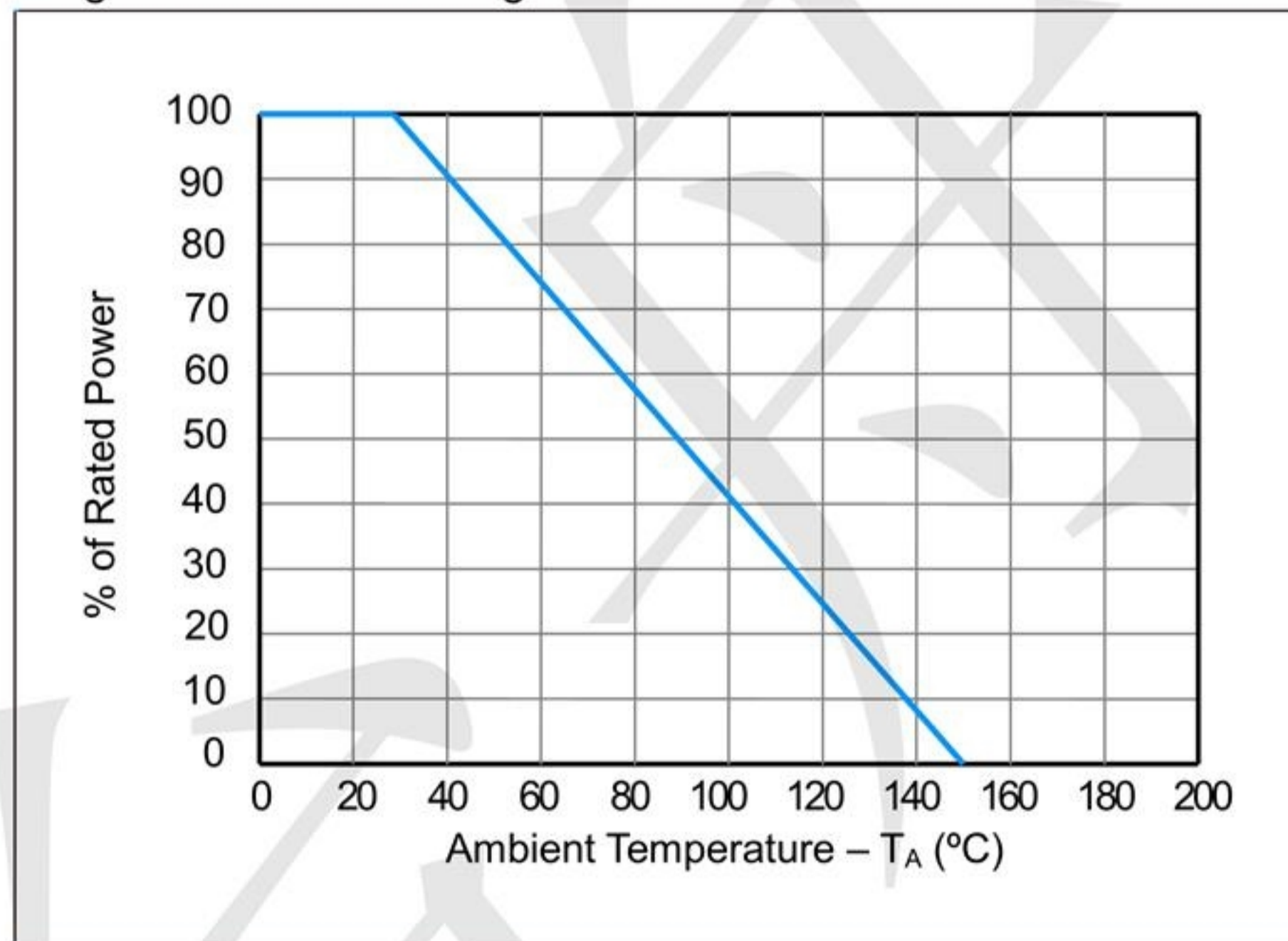
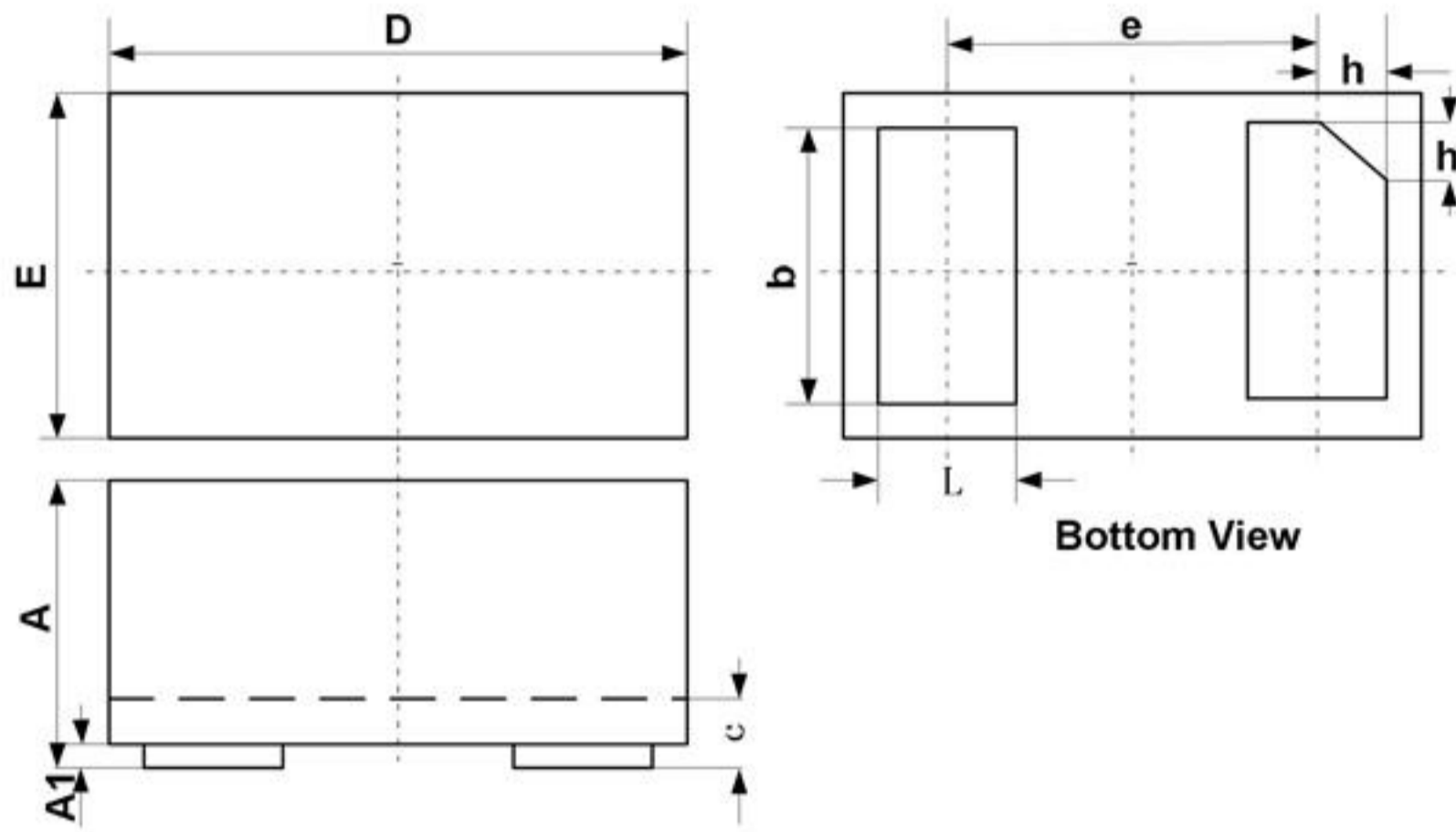

Fig3. Power Derating Curve





DFN1610-2 Package Outline Drawing



SYM	DIMENSIONS					
	MILLIMETERS			INCHES		
	MIN	NOM	MAX	MIN	NOM	MAX
A	0.45	0.50	0.55	0.018	0.020	0.022
A1	0.00	0.02	0.05	0.000	0.001	0.002
b	0.75	0.80	0.85	0.030	0.032	0.034
c	0.10	0.15	0.20	0.004	0.006	0.008
D	1.55	1.60	1.65	0.062	0.064	0.066
e	1.10 BSC			0.044 BSC		
E	0.95	1.00	1.05	0.038	0.040	0.042
L	0.35	0.40	0.45	0.014	0.016	0.018
h	0.15	0.20	0.25	0.006	0.008	0.010

Suggested Land Pattern

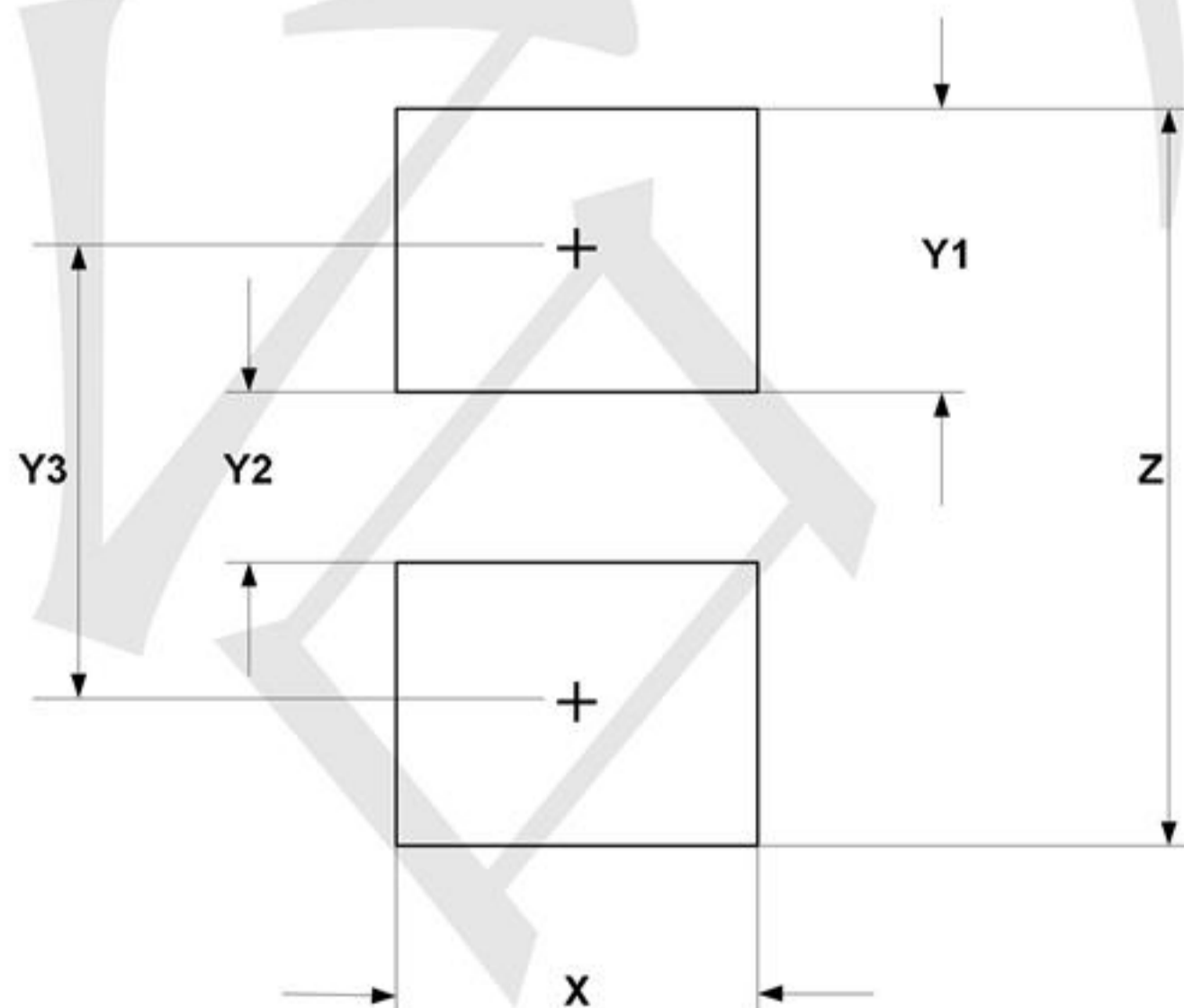

SYM	DIMENSIONS	
	MILLIMETERS	INCHES
X	1.00	0.040
Y1	0.62	0.025
Y2	0.60	0.024
Y3	1.22	0.049
Z	1.85	0.074