

FEATURES

- Accurate rms-to-dc conversion from 200 MHz to 6 GHz
- Measurement dynamic range of 35 dB
- Ripple-free transfer function
- Single-ended input, 50 Ω source compatible
- No external matching required
- Waveform and modulation independent, such as GSM/CDMA/W-CDMA/TD-SCDMA/LTE
- Linear in decibels output, scaled 35.5 mV/dB at 900 MHz
- Excellent temperature stability
- Operates from 3.0 V to 5.0 V from -55°C to +125°C
- Low power consumption: 3 mA at 3.0 V to 5.0 V supply
- 8-lead, 2 mm × 2 mm LFCSP package

APPLICATIONS

- Power amplifier linearization/control loops
- Transmitter power controls
- Transmitter signal strength indication (TSSI)
- RF instrumentation
- Wireless repeaters

GENERAL DESCRIPTION

The [ADL5903](#) is a true rms responding power detector that has a 35 dB measurement range. It features low power consumption and an intrinsically ripple-free error transfer function.

The [ADL5903](#) provides a solution in a variety of high frequency systems requiring an accurate measurement of signal power. Requiring only a single supply of 3.0 V to 5.0 V and a few capacitors, it is easy to use and capable of being driven single-ended or with a balun for differential input drive. An on-chip matching network provides good return loss over the specified frequency range of the device. The [ADL5903](#) can operate from 200 MHz to 6 GHz and can accept inputs from -30 dBm to +20 dBm.

FUNCTIONAL BLOCK DIAGRAM

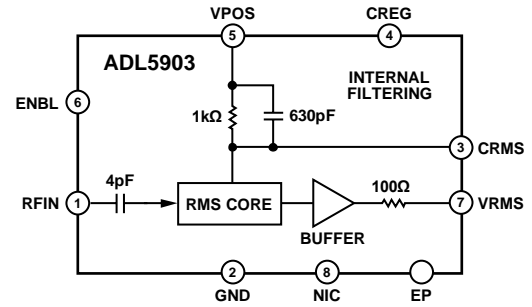

Figure 1.

The [ADL5903](#) can be used to determine the true power of a high frequency signal with a complex modulation envelope including large crest factor signals such as GSM, CDMA, W-CDMA, TD-SCDMA, and LTE modulated signals. The output is then proportional to the logarithm of the rms value of the input. In other words, the reading is presented directly in decibels and is scaled about 35.5 mV/dB at 900 MHz.

The [ADL5903](#) has low power consumption when operational and a disable mode that further reduces the power consumption. Power consumption is less than 100 μA when the [ADL5903](#) enters power-down mode through a logic low at Pin ENBL. The [ADL5903](#) is supplied in a 2 mm × 2 mm, 8-lead LFCSP for operation over the wide temperature range of -55°C to +125°C.

TABLE OF CONTENTS

Features	1	Measurement Setups	14
Applications.....	1	Theory of Operation	15
Functional Block Diagram	1	RF Input Interface	15
General Description	1	Basic Connections.....	15
Revision History	2	Choosing a Value for C_{RMS}	16
Specifications.....	3	Device Calibration and Error Calculation.....	17
Absolute Maximum Ratings.....	6	Evaluation Board Schematic and Configuration Options	19
ESD Caution.....	6	Outline Dimensions	20
Pin Configuration and Function Descriptions.....	7	Ordering Guide	20
Typical Performance Characteristics	8		

REVISION HISTORY

5/15—Rev. A to Rev. B

Changes to Figure 49..... 19

2/15—Rev. 0 to Rev. A

Added ADL5903ACPZN Operating Temperature Range of
 -40°C to +85°C; Table 2 6

Changes to Ordering Guide
 20 |

10/13—Revision 0: Initial Version

SPECIFICATIONS

VPOS = 5.0 V, $T_A = 25^\circ\text{C}$, $Z_o = 50 \Omega$, Capacitor $C_{\text{RMS}} = 10 \text{ nF}$, unless otherwise noted.

Table 1.

Parameter	Test Conditions/Comments	Min	Typ	Max	Unit
OVERALL FUNCTION					
Frequency Range			200 to 6000		MHz
RF INPUT INTERFACE	Pin RFIN				
Nominal Input Impedance ¹	Single-ended drive		50		Ω
OUTPUT INTERFACE	Pin VRMS				
DC Output Resistance			100		Ω
Rise Time	$P_{\text{IN}} = \text{off to } 0 \text{ dBm, } 10\% \text{ to } 90\%, C_{\text{RMS}} = 10 \text{ nF}$		3.5		μs
	$P_{\text{IN}} = \text{off to } 0 \text{ dBm, } 10\% \text{ to } 90\%, C_{\text{RMS}} = 100 \text{ nF}$		34		μs
Fall Time	$P_{\text{IN}} = 0 \text{ dBm to off, } 90\% \text{ to } 10\%, C_{\text{RMS}} = 10 \text{ nF}$		32		μs
	$P_{\text{IN}} = 0 \text{ dBm to off, } 90\% \text{ to } 10\%, C_{\text{RMS}} = 100 \text{ nF}$		330		μs
$f = 300 \text{ MHz}$					
$\pm 1.0 \text{ dB Dynamic Range}$	Continuous wave (CW) input, $T_A = 25^\circ\text{C}$, VPOS = 5.0 V		37		dB
	CW input, $T_A = 25^\circ\text{C}$, VPOS = 3.0 V		34		dB
Maximum Input Level, $\pm 1.0 \text{ dB}$	Three-point calibration at $-16 \text{ dBm, } -4 \text{ dBm, and } +12 \text{ dBm}$		13		dBm
Minimum Input Level, $\pm 1.0 \text{ dB}$	Three-point calibration at $-16 \text{ dBm, } -4 \text{ dBm, and } +12 \text{ dBm}$		-24		dBm
Deviation vs. Temperature	Deviation from output at 25°C				
	$-40^\circ\text{C} < T_A < +85^\circ\text{C}; P_{\text{IN}} = 10 \text{ dBm}$		$-0.2/+0.03^2$		dB
	$-55^\circ\text{C} < T_A < +125^\circ\text{C}; P_{\text{IN}} = 10 \text{ dBm}$		$-0.25/+0.05^2$		dB
	$-40^\circ\text{C} < T_A < +85^\circ\text{C}; P_{\text{IN}} = -10 \text{ dBm}$		$-0.2/+0.15^2$		dB
	$-55^\circ\text{C} < T_A < +125^\circ\text{C}; P_{\text{IN}} = -10 \text{ dBm}$		$-0.25/+0.2^2$		dB
Logarithmic Slope	Calibration at $-16 \text{ dBm and } +4 \text{ dBm}$		36.3		mV/dB
Logarithmic Intercept	Calibration at $-16 \text{ dBm and } +4 \text{ dBm}$ (X-intercept)		-39		dBm
$f = 700 \text{ MHz}$					
$\pm 1.0 \text{ dB Dynamic Range}$	CW input, $T_A = 25^\circ\text{C}$, VPOS = 5.0 V		37		dB
	CW input, $T_A = 25^\circ\text{C}$, VPOS = 3.0 V		34		dB
Maximum Input Level, $\pm 1.0 \text{ dB}$	Three-point calibration at $-16 \text{ dBm, } -3 \text{ dBm, and } +13 \text{ dBm}$		14		dBm
Minimum Input Level, $\pm 1.0 \text{ dB}$	Three-point calibration at $-16 \text{ dBm, } -3 \text{ dBm, and } +13 \text{ dBm}$		-23		dBm
Deviation vs. Temperature	Deviation from output at 25°C				
	$-40^\circ\text{C} < T_A < +85^\circ\text{C}; P_{\text{IN}} = 10 \text{ dBm}$		-0.13		dB
	$-55^\circ\text{C} < T_A < +125^\circ\text{C}; P_{\text{IN}} = 10 \text{ dBm}$		-0.16		dB
	$-40^\circ\text{C} < T_A < +85^\circ\text{C}; P_{\text{IN}} = -10 \text{ dBm}$		$-0.15/+0.1^2$		dB
	$-55^\circ\text{C} < T_A < +125^\circ\text{C}; P_{\text{IN}} = -10 \text{ dBm}$		$-0.2/+0.2^2$		dB
Logarithmic Slope	Calibration at $-16 \text{ dBm and } +4 \text{ dBm}$		36.4		mV/dB
Logarithmic Intercept	Calibration at $-16 \text{ dBm and } +4 \text{ dBm}$ (X-intercept)		-38		dBm
$f = 900 \text{ MHz}$					
$\pm 1.0 \text{ dB Dynamic Range}$	CW input, $T_A = 25^\circ\text{C}$, VPOS = 5.0 V		37		dB
	CW input, $T_A = 25^\circ\text{C}$, VPOS = 3.0 V		33		dB
Maximum Input Level, $\pm 1.0 \text{ dB}$	Three-point calibration at $-16 \text{ dBm, } -3 \text{ dBm, and } +13 \text{ dBm}$		14		dBm
Minimum Input Level, $\pm 1.0 \text{ dB}$	Three-point calibration at $-16 \text{ dBm, } -3 \text{ dBm, and } +13 \text{ dBm}$		-23		dBm
Deviation vs. Temperature	Deviation from output at 25°C				
	$-40^\circ\text{C} < T_A < +85^\circ\text{C}; P_{\text{IN}} = 10 \text{ dBm}$		-0.12		dB
	$-55^\circ\text{C} < T_A < +125^\circ\text{C}; P_{\text{IN}} = 10 \text{ dBm}$		$-0.15/+0.02^2$		dB
	$-40^\circ\text{C} < T_A < +85^\circ\text{C}; P_{\text{IN}} = -10 \text{ dBm}$		$-0.1/+0.02^2$		dB
	$-55^\circ\text{C} < T_A < +125^\circ\text{C}; P_{\text{IN}} = -10 \text{ dBm}$		$-0.1/+0.1^2$		dB
Logarithmic Slope	Calibration at $-16 \text{ dBm and } +4 \text{ dBm}$		35.5		mV/dB
Logarithmic Intercept	Calibration at $-16 \text{ dBm and } +4 \text{ dBm}$ (X-intercept)		-38		dBm

Parameter	Test Conditions/Comments	Min	Typ	Max	Unit
f = 1900 MHz ±1.0 dB Dynamic Range Maximum Input Level, ±1.0 dB Minimum Input Level, ±1.0 dB Deviation vs. Temperature Logarithmic Slope Logarithmic Intercept	CW input, T _A = 25°C, VPOS = 5.0 V		37		dB
	CW input, T _A = 25°C, VPOS = 3.0 V		33		dB
	Three-point calibration at -15 dBm, -3 dBm, and +13 dBm		15		dBm
	Three-point calibration at -15 dBm, -3 dBm, and +13 dBm		-22		dBm
	Deviation from output at 25°C				
	-40°C < T _A < +85°C; P _{IN} = 10 dBm		-0.15		dB
	-55°C < T _A < +125°C; P _{IN} = 10 dBm		-0.15		dB
	-40°C < T _A < +85°C; P _{IN} = -10 dBm		-0.3/+0.2 ²		dB
	-55°C < T _A < +125°C; P _{IN} = -10 dBm		-0.35/+0.25 ²		dB
	Calibration at -16 dBm and +4 dBm		37.2		mV/dB
Calibration at -16 dBm and +4 dBm (X-intercept)		-35.5		dBm	
f = 2140 MHz ±1.0 dB Dynamic Range Maximum Input Level, ±1.0 dB Minimum Input Level, ±1.0 dB Deviation vs. Temperature Logarithmic Slope Logarithmic Intercept	CW input, T _A = 25°C, VPOS = 5.0 V		35		dB
	CW input, T _A = 25°C, VPOS = 3.0 V		32		dB
	Three-point calibration at -15 dBm, -3 dBm, and +13 dBm		15		dBm
	Three-point calibration at -15 dBm, -3 dBm, and +13 dBm		-20		dBm
	Deviation from output at 25°C				
	-40°C < T _A < +85°C; P _{IN} = 10 dBm		-0.2		dB
	-55°C < T _A < +125°C; P _{IN} = 10 dBm		-0.2		dB
	-40°C < T _A < +85°C; P _{IN} = -10 dBm		-0.4/+0.2 ²		dB
	-55°C < T _A < +125°C; P _{IN} = -10 dBm		-0.5/+0.3 ²		dB
	Calibration at -16 dBm and +4 dBm		37.4		mV/dB
Calibration at -16 dBm and +4 dBm (X-intercept)		-35		dBm	
f = 2600 MHz ±1.0 dB Dynamic Range Maximum Input Level, ±1.0 dB Minimum Input Level, ±1.0 dB Deviation vs. Temperature Logarithmic Slope Logarithmic Intercept	CW input, T _A = 25°C, VPOS = 5.0 V		34		dB
	CW input, T _A = 25°C, VPOS = 3.0 V		32		dB
	Three-point calibration at -14 dBm, -2 dBm, and +14 dBm		15		dBm
	Three-point calibration at -14 dBm, -2 dBm, and +14 dBm		-19		dBm
	Deviation from output at 25°C				
	-40°C < T _A < +85°C; P _{IN} = 10 dBm		-0.2		dB
	-55°C < T _A < +125°C; P _{IN} = 10 dBm		-0.25		dB
	-40°C < T _A < +85°C; P _{IN} = -10 dBm		-0.5/+0.2 ²		dB
	-55°C < T _A < +125°C; P _{IN} = -10 dBm		-0.6/+0.3 ²		dB
	Calibration at -16 dBm and +4 dBm		37.7		mV/dB
Calibration at -16 dBm and +4 dBm (X-intercept)		-34		dBm	
f = 3500 MHz ±1.0 dB Dynamic Range Maximum Input Level, ±1.0 dB Minimum Input Level, ±1.0 dB Deviation vs. Temperature Logarithmic Slope Logarithmic Intercept	CW input, T _A = 25°C, VPOS = 5.0 V		33		dB
	CW input, T _A = 25°C, VPOS = 3.0 V		31		dB
	Three-point calibration at -12 dBm, 0 dBm, and +14 dBm		16		dBm
	Three-point calibration at -12 dBm, 0 dBm, and +14 dBm		-17		dBm
	Deviation from output at 25°C				
	-40°C < T _A < +85°C; P _{IN} = 10 dBm		-0.2		dB
	-55°C < T _A < +125°C; P _{IN} = 10 dBm		-0.25		dB
	-40°C < T _A < +85°C; P _{IN} = -10 dBm		-0.6/+0.3 ²		dB
	-55°C < T _A < +125°C; P _{IN} = -10 dBm		-0.75/+0.4 ²		dB
	Calibration at -12 dBm and +8 dBm		39		mV/dB
Calibration at -12 dBm and +8 dBm (X-intercept)		-31.5		dBm	

Parameter	Test Conditions/Comments	Min	Typ	Max	Unit
f = 5800 MHz					
±1.0 dB Dynamic Range	CW input, T _A = 25°C, VPOS = 5.0 V		35		dB
	CW input, T _A = 25°C, VPOS = 3.0 V		32		dB
Maximum Input Level, ±1.0 dB	Three-point calibration at -12 dBm, -2 dBm, and +12 dBm		19		dBm
Minimum Input Level, ±1.0 dB	Three-point calibration at -12 dBm, -2 dBm, and +12 dBm		-16		dBm
Deviation vs. Temperature	Deviation from output at 25°C				
	-40°C < T _A < +85°C; P _{IN} = 10 dBm		-0.6/+0.3 ²		dB
	-55°C < T _A < +125°C; P _{IN} = 10 dBm		-0.7/+0.4 ²		dB
	-40°C < T _A < +85°C; P _{IN} = -10 dBm		-1.1/+0.7 ²		dB
	-55°C < T _A < +125°C; P _{IN} = -10 dBm		-1.4/+1.1 ²		dB
Logarithmic Slope	Calibration at -12 dBm and +8 dBm		40		mV/dB
Logarithmic Intercept	Calibration at -12 dBm and +8 dBm (X-intercept)		-27		dBm
POWER-DOWN INTERFACE	Pin ENBL				
Voltage Level to Enable		2		VPOS	V
Voltage Level to Disable		0		0.6	V
Input Bias Current	V _{ENBL} = 2.2 V		<20		nA
POWER SUPPLY INTERFACE	Pin VPOS				
Supply Voltage		3.0		5.25	V
Quiescent Current	T _A = 25°C, no signal at RFIN, VPOS = 5.0 V		3		mA
	T _A = 125°C, no signal at RFIN, VPOS = 5.0 V		3.6		mA
Power-Down Current	ENBL input low condition		<100		μA

¹ Refer to Figure 12, input return loss, S₁₁ (dB).

² The slash indicates a range. For example, -0.2/+0.03 means -0.2 to +0.03.

ABSOLUTE MAXIMUM RATINGS

Table 2.

Parameter	Rating
Supply Voltage, VPOS	5.5 V
Input Average RF Power ^{1, 2}	20 dBm
Equivalent Voltage, Sine Wave Input	3.16 V peak
Internal Power Dissipation	200 mW
θ_{JC} ³	3.95°C/W
θ_{JA} ³	78.5°C/W
Maximum Junction Temperature	150°C
Operating Temperature Range (ADL5903ACPZN)	–40°C to +85°C
Operating Temperature Range (ADL5903SCPZN)	–55°C to +125°C
Storage Temperature Range	–65°C to +150°C
Lead Temperature (Soldering, 60 sec)	300°C

¹ This is for long durations. Excursions above this level, with durations much less than 1 second, are possible without damage.

² Driven from a 50 Ω source.

³ No airflow with the exposed pad soldered to a 4-layer JEDEC board.

Stresses at or above those listed under Absolute Maximum Ratings may cause permanent damage to the product. This is a stress rating only; functional operation of the product at these or any other conditions above those indicated in the operational section of this specification is not implied. Operation beyond the maximum operating conditions for extended periods may affect product reliability.

ESD CAUTION



ESD (electrostatic discharge) sensitive device. Charged devices and circuit boards can discharge without detection. Although this product features patented or proprietary protection circuitry, damage may occur on devices subjected to high energy ESD. Therefore, proper ESD precautions should be taken to avoid performance degradation or loss of functionality.

PIN CONFIGURATION AND FUNCTION DESCRIPTIONS

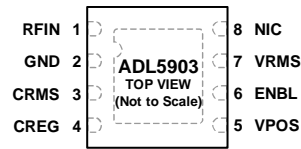

NOTES

1. NIC = NO INTERNAL CONNECTION.
2. THE EXPOSED PAD IS INTERNALLY CONNECTED TO GND AND REQUIRES A GOOD THERMAL AND ELECTRICAL CONNECTION TO THE GROUND OF THE PRINTED CIRCUIT BOARD (PCB).

1176B-002

Figure 2. Pin Configuration

Table 3. Pin Function Descriptions

Pin No.	Mnemonic	Description
1	RFIN	Signal Input. This pin is internally ac-coupled with a broadband matching network. See the RF Input Interface section for broadband matching options.
2	GND	Device Ground. Connect GND to system ground using a low impedance path.
3	CRMS	RMS Averaging Pin. Connect a capacitor between the CREG and CRMS pins for rms averaging. See the Choosing a Value for C_{RMS} section for choosing the correct C_{RMS} capacitor value.
4	CREG	Bypass Capacitor Connection for On-Chip Regulator. Bypass this pin to ground using a capacitor and a series resistor. See Basic Connections section for more information.
5	VPOS	Supply Voltage. The operational range is 3.0 V to 5.25 V.
6	ENBL	Enable. Connect the ENBL pin to a logic high (2 V to VPOS) to enable the device. Connect the ENBL pin to a logic low (0 V to 0.6 V) to disable the device.
7	VRMS	Signal Output. The output from the VRMS pin is proportional to the logarithm of the rms value at the input level.
8	NIC	No Internal Connection. Do not connect to this pin. This pin is not internally connected.
0	EP	Exposed Pad. The exposed pad is internally connected to GND and requires a good thermal and electrical connection to the ground of the printed circuit board (PCB).

TYPICAL PERFORMANCE CHARACTERISTICS

VPOS = 5.0 V, C_{RMS} = 10 nF, T_A = -55°C (light blue), T_A = -40°C (blue), +25°C (green), +85°C (red), +125°C (orange) where appropriate. Input levels referred to 50 Ω source. Input RF signal is a sine wave (CW), unless otherwise indicated.

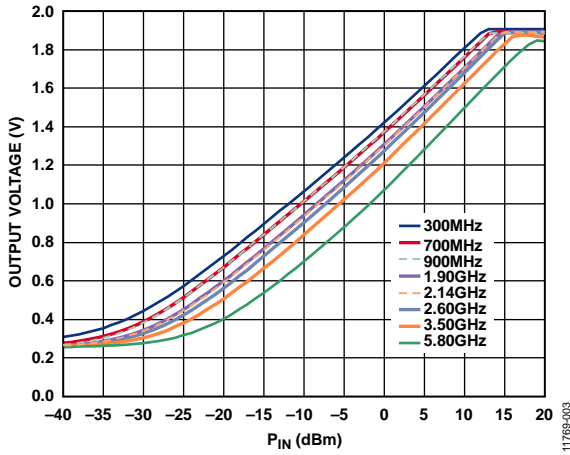

Figure 3. Typical V_{RMS} vs. Input Level vs. Frequency (300 MHz to 5.80 GHz) at 25°C

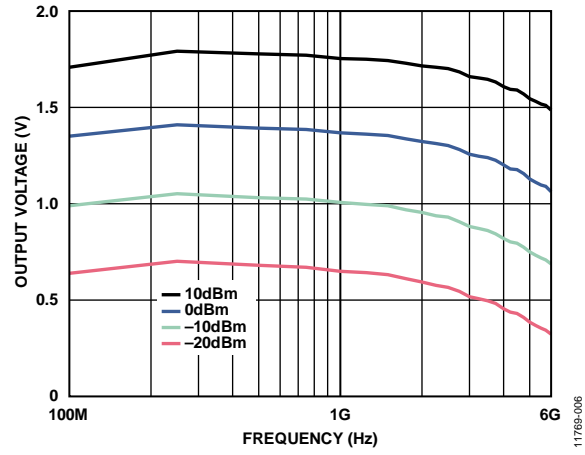

Figure 6. Typical V_{RMS} vs. Frequency for Four Input Levels

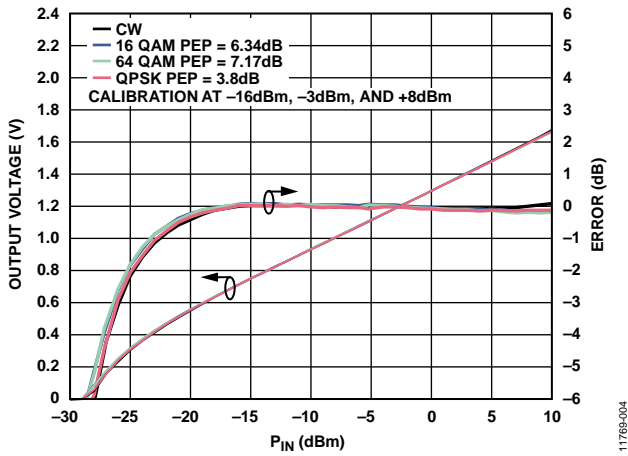

Figure 4. Error from CW Linear Reference vs. Input Level and Signal Modulation (QPSK, 16 QAM, 64 QAM), Frequency = 900 MHz, C_{RMS} = 1 μF

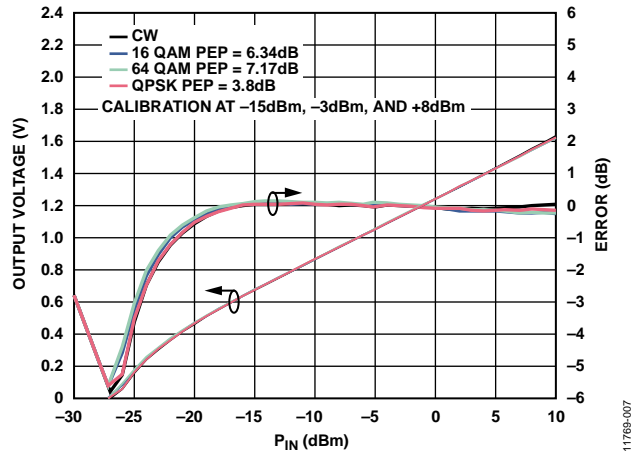

Figure 7. Error from CW Linear Reference vs. Input Level and Signal Modulation (QPSK, 16 QAM, 64 QAM), Frequency = 2.14 GHz, C_{RMS} = 1 μF

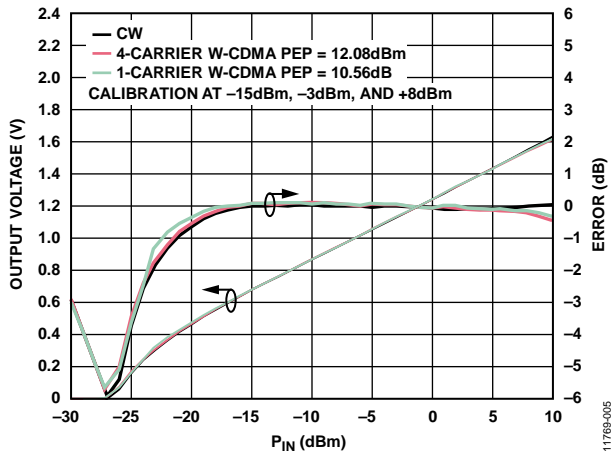

Figure 5. Error from CW Linear Reference vs. Input Level and Signal Modulation (One-Carrier W-CDMA, Four-Carrier W-CDMA), Frequency = 2.14 GHz, C_{RMS} = 1 μF

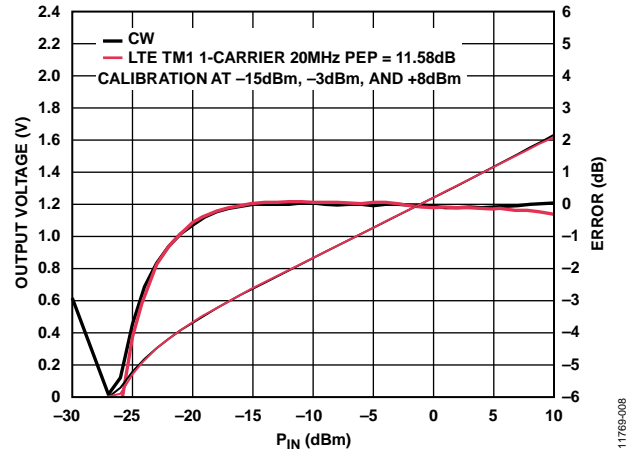

Figure 8. Error from CW Linear Reference vs. Input Level and Signal Modulation (LTE TM1 One-Carrier, 20 MHz), Frequency = 2.14 GHz, C_{RMS} = 1 μF

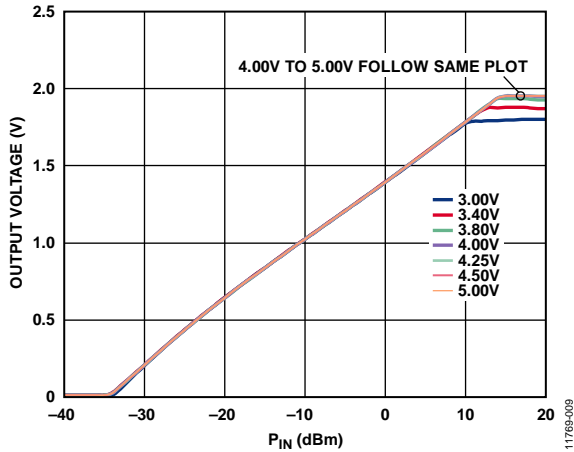

Figure 9. Output Voltage vs. Input Level and Supply Voltage at 900 MHz

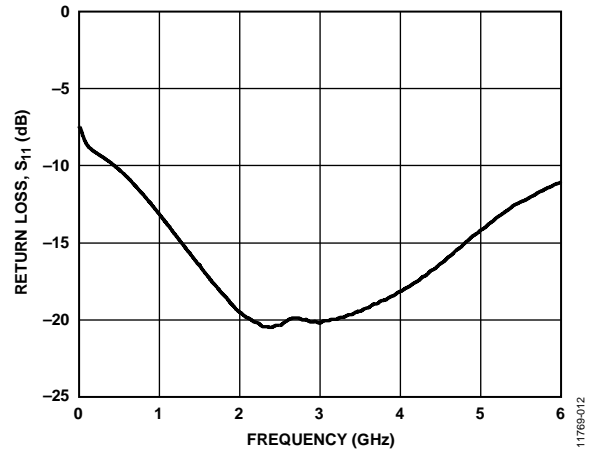

Figure 12. Input Return Loss vs. RF Frequency

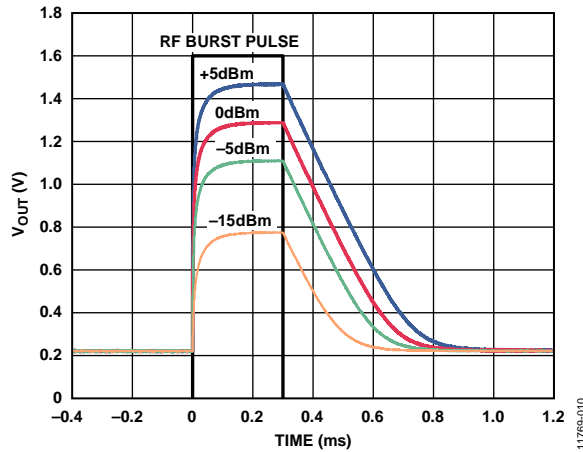

Figure 10. Output Response to RF Burst Input, Carrier Frequency = 900 MHz, $C_{RMS} = 100$ nF (see Figure 36 in the Measurement Setups Section)

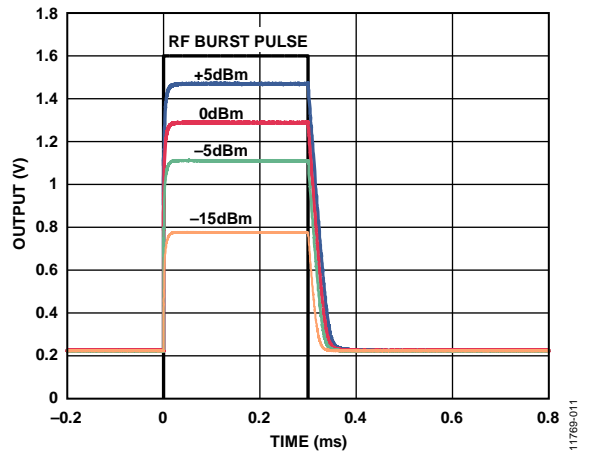

Figure 13. Output Response to RF Burst Input, Carrier Frequency = 900 MHz, $C_{RMS} = 10$ nF (see Figure 36 in the Measurement Setups Section)

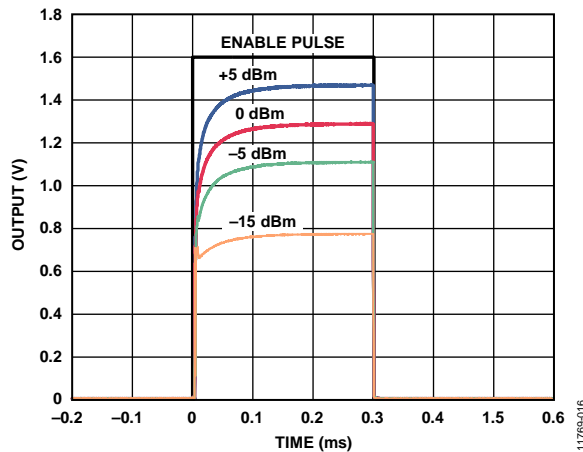

Figure 11. Output Response to Gating on ENBL Pin for Various RF Input Levels, Carrier Frequency = 900 MHz, $C_{RMS} = 100$ nF (see Figure 38 in the Measurement Setups Section)

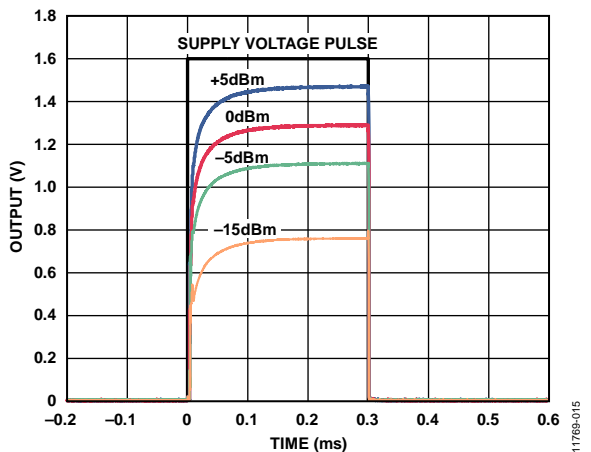

Figure 14. Output Response to Gating on Power Supply for Various RF Input Levels, Carrier Frequency = 900 MHz, $C_{RMS} = 100$ nF, 5.0 V Supply (see Figure 37, in the Measurement Setups Section)

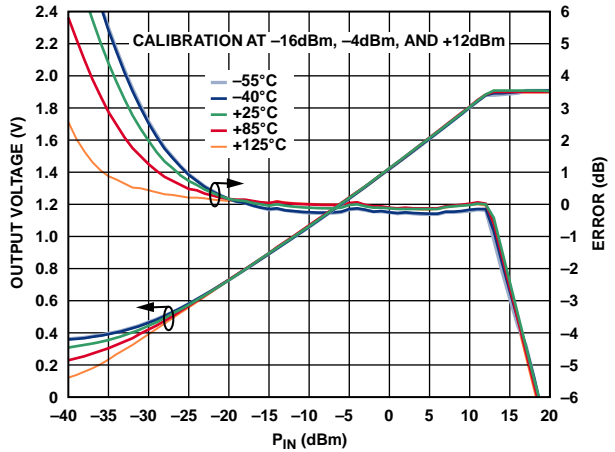

Figure 15. V_{RMS} and Log Conformance Error vs. Input Level and Temperature at 300 MHz

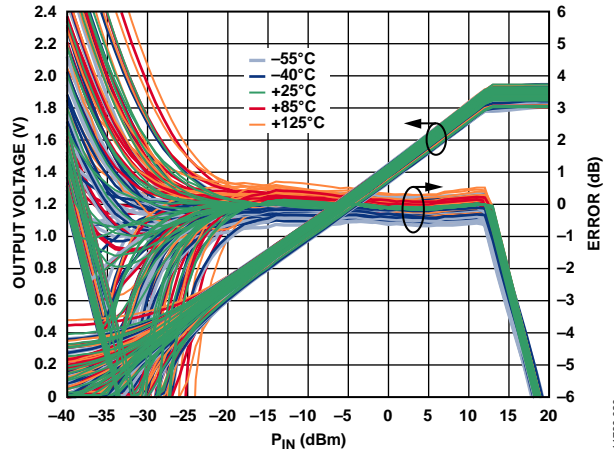

Figure 18. Distribution of Log Conformance Error with Respect to Calibration at 25°C vs. Input Level and Temperature at 300 MHz

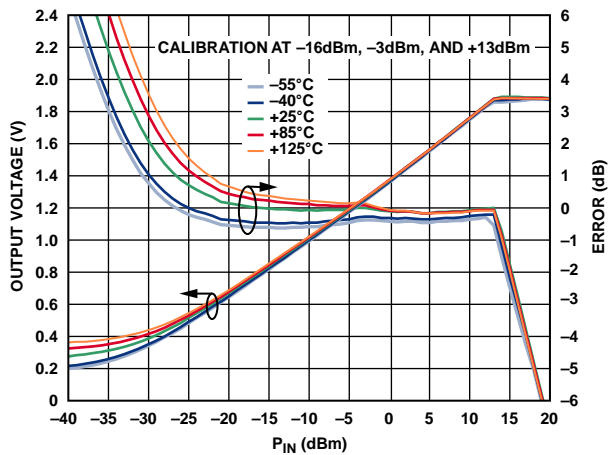

Figure 16. V_{RMS} and Log Conformance Error vs. Input Level and Temperature at 700 MHz

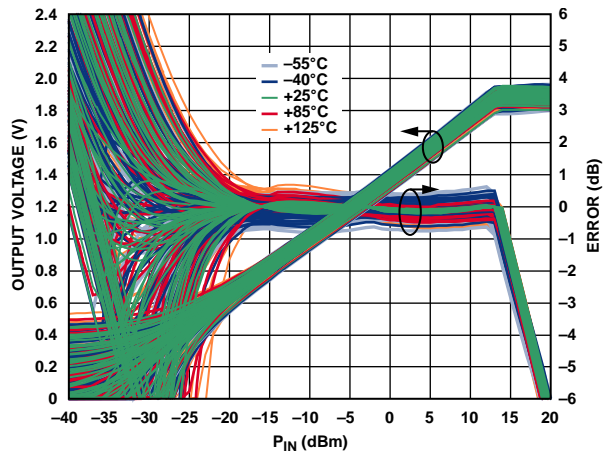

Figure 19. Distribution of Log Conformance Error with Respect to Calibration at 25°C vs. Input Level and Temperature at 700 MHz

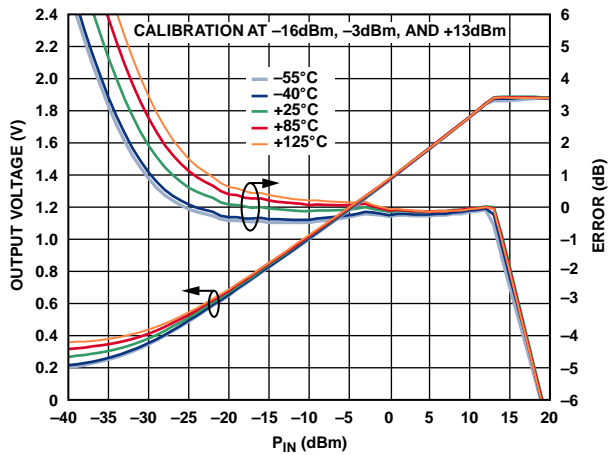

Figure 17. V_{RMS} and Log Conformance Error vs. Input Level and Temperature at 900 MHz

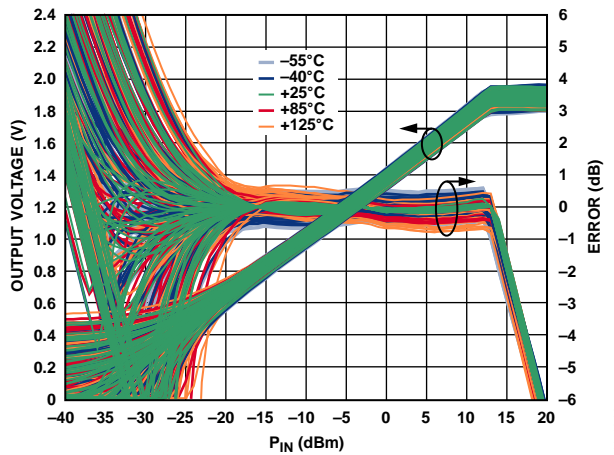

Figure 20. Distribution of Log Conformance Error with Respect to Calibration at 25°C vs. Input Level and Temperature at 900 MHz

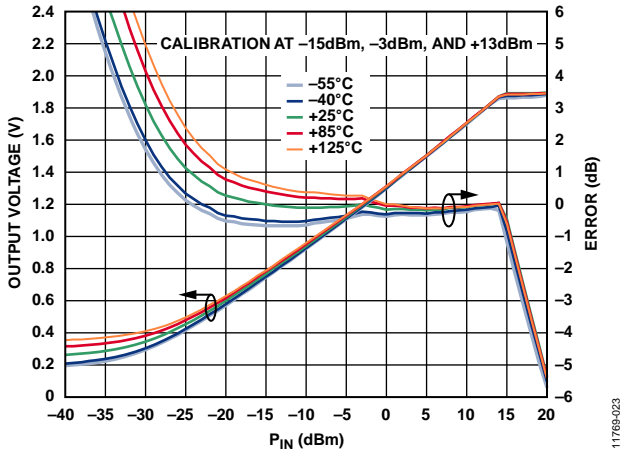

Figure 21. V_{RMS} and Log Conformance Error vs. Input Level and Temperature at 1.9 GHz

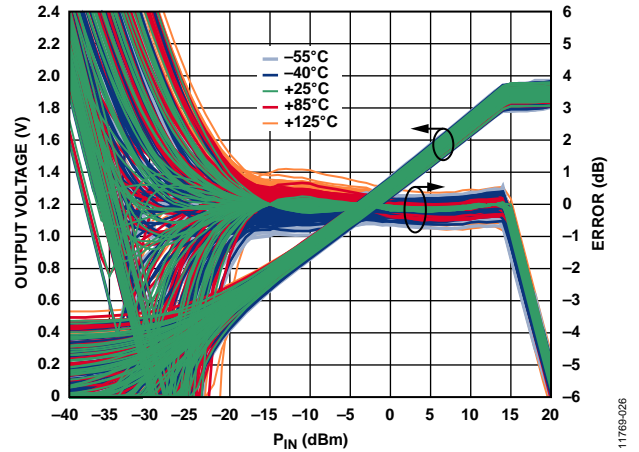

Figure 24. Distribution of Log Conformance Error with Respect to Calibration at 25°C vs. Input Level and Temperature at 1.9 GHz

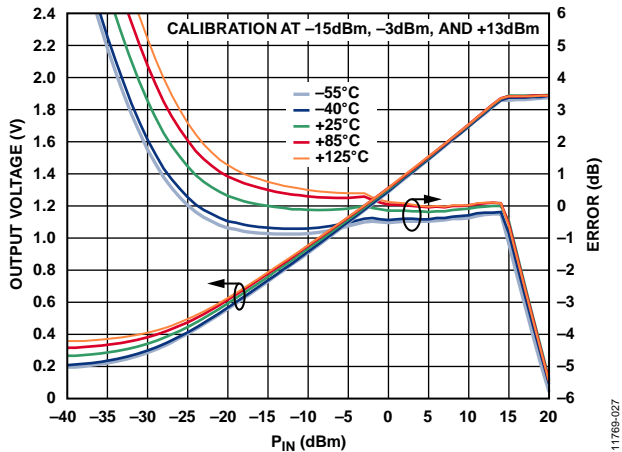

Figure 22. V_{RMS} and Log Conformance Error vs. Input Level and Temperature at 2.14 GHz

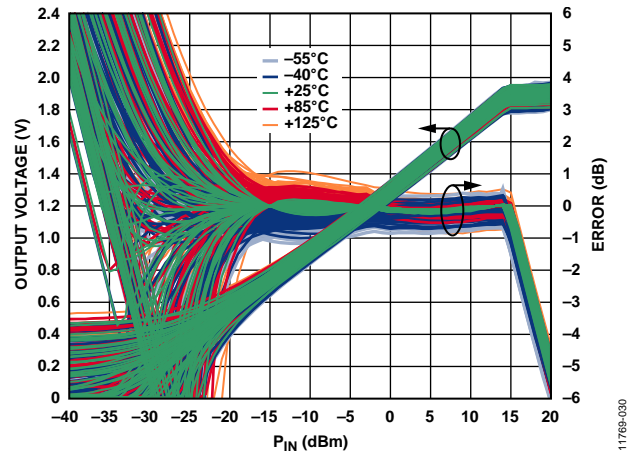

Figure 25. Distribution of Log Conformance Error with Respect to Calibration at 25°C vs. Input Level and Temperature at 2.14 GHz

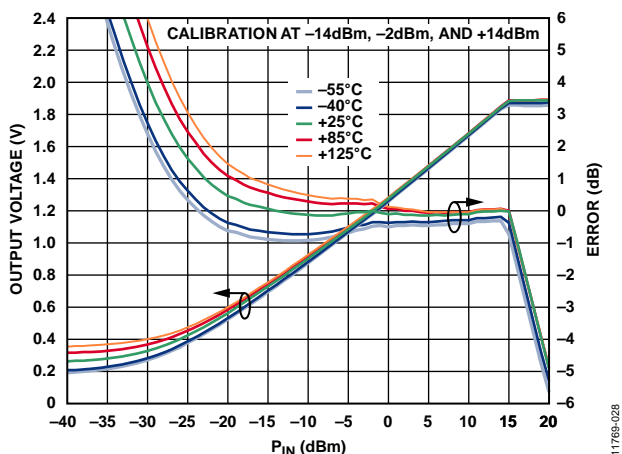

Figure 23. V_{RMS} and Log Conformance Error vs. Input Level and Temperature at 2.6 GHz

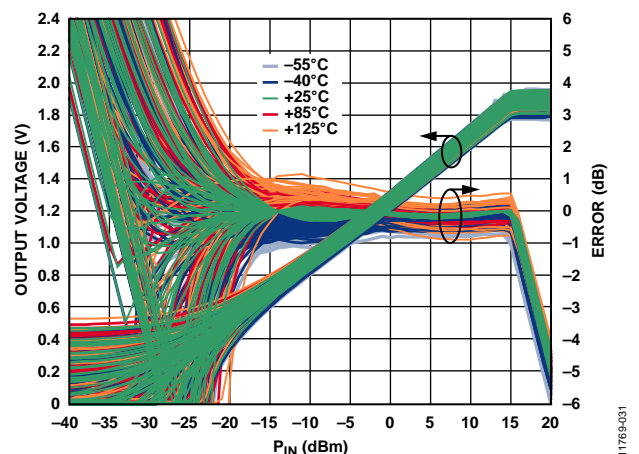

Figure 26. Distribution of Log Conformance Error with Respect to Calibration at 25°C vs. Input Level and Temperature at 2.6 GHz

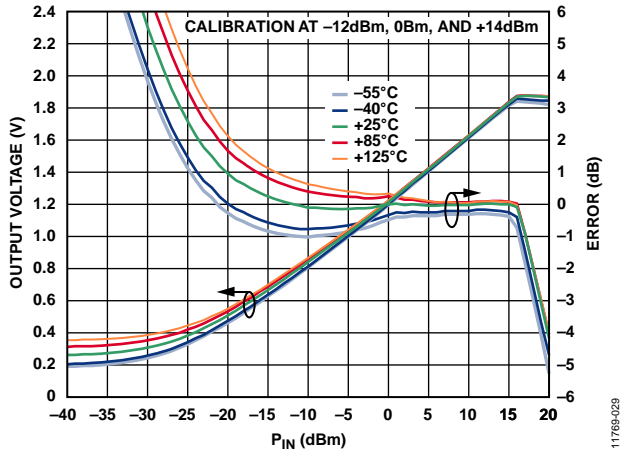

Figure 27. V_{RMS} and Log Conformance Error vs. Input Level and Temperature at 3.5 GHz

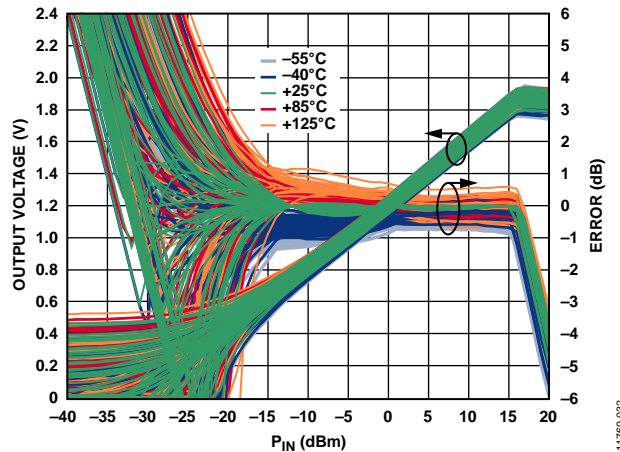

Figure 30. Distribution of Log Conformance Error with Respect to Calibration at 25°C vs. Input Level and Temperature at 3.5 GHz

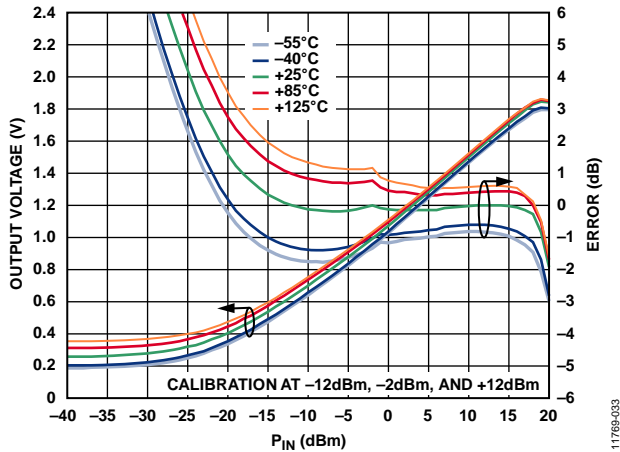

Figure 28. V_{RMS} and Log Conformance Error vs. Input Level and Temperature at 5.8 GHz

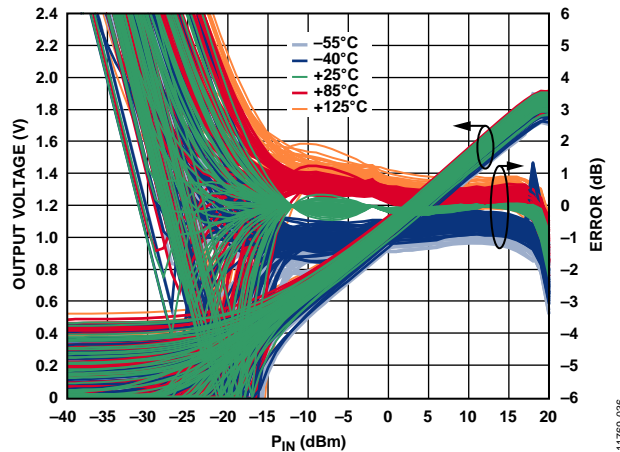

Figure 31. Distribution of Log Conformance Error with Respect to Calibration at 25°C vs. Input Level and Temperature at 5.8 GHz

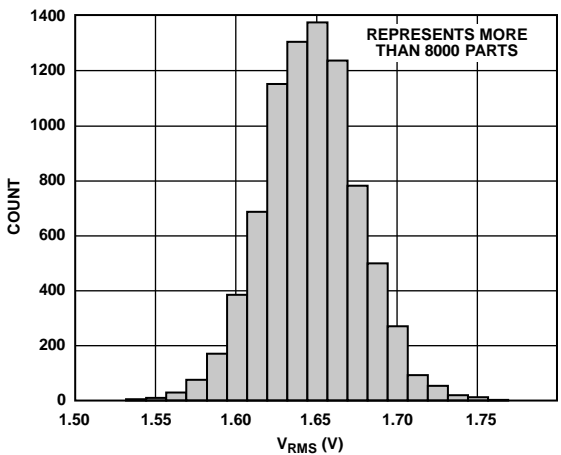

Figure 29. Distribution of V_{RMS} , $P_{IN} = 8$ dBm, 900 MHz

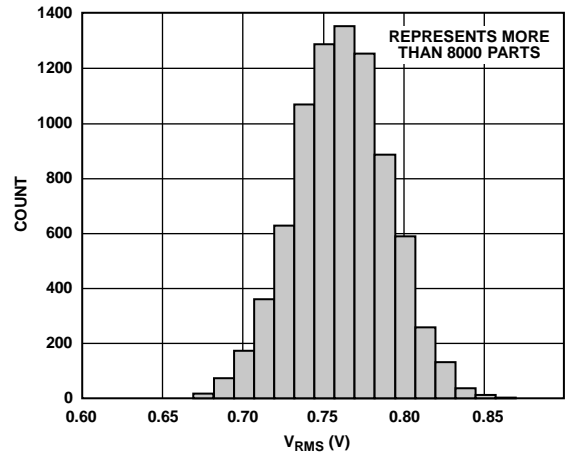

Figure 32. Distribution of V_{RMS} , $P_{IN} = -16$ dBm, 900 MHz

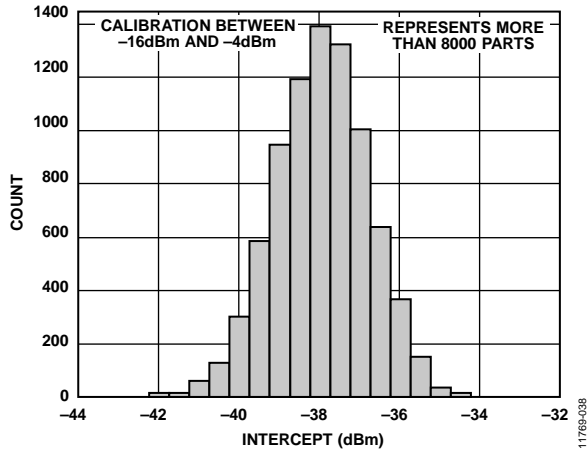

Figure 33. Distribution of Intercept at 900 MHz

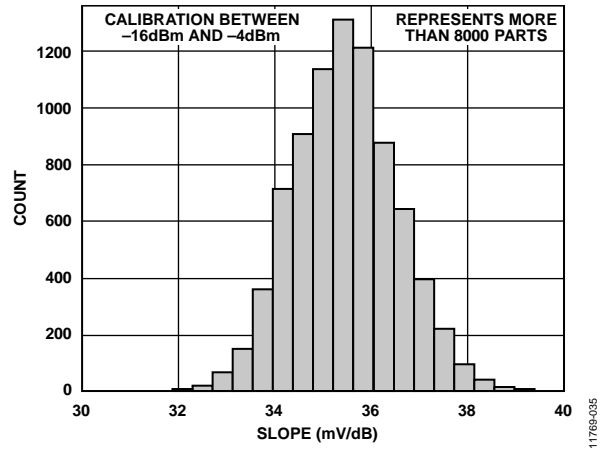

Figure 35. Distribution of Slope at 900 MHz

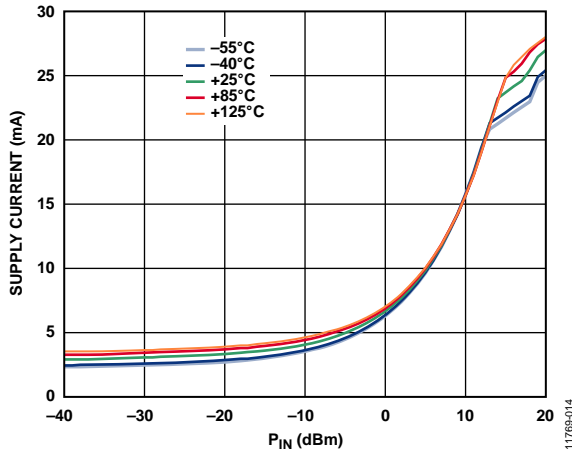

Figure 34. Supply Current vs. Input Level (at -55°C, -40°C, +25°C, +85°C, +125°C)

MEASUREMENT SETUPS

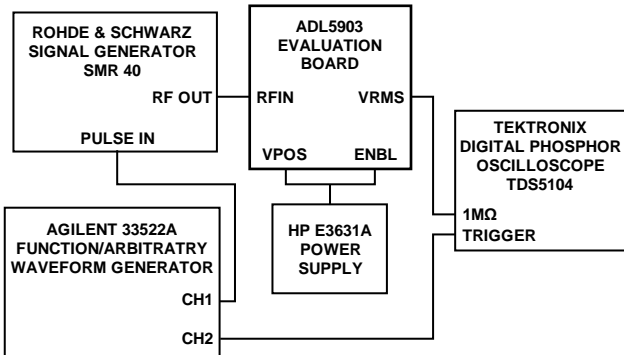

Figure 36. Hardware Configuration for Output Response to RF Burst Input Measurements

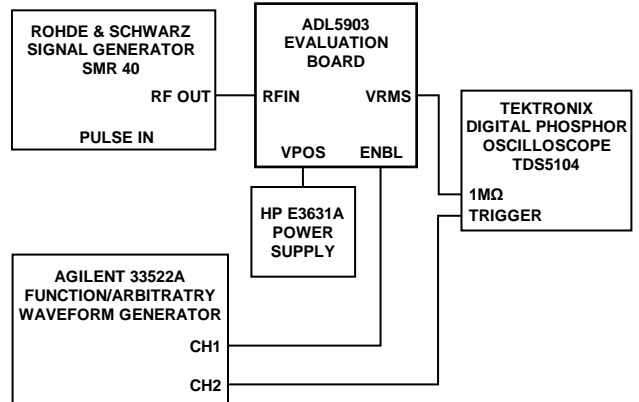

Figure 38. Hardware Configuration for Output Response to ENBL Pin Gating Measurements

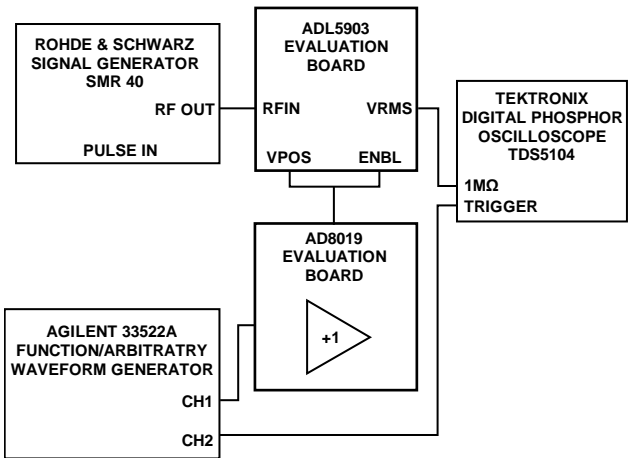

Figure 37. Hardware Configuration for Output Response to Power Supply Gating Measurements

THEORY OF OPERATION

The **ADL5903** is a true rms detector with a 35 dB measurement range at 2.14 GHz with useable range up to 6 GHz. It features no error ripple over its range, low temperature drift, and very low power consumption. Temperature stability of the rms output measurements provides $\leq \pm 0.5$ dB error typical over the temperature range of -40°C to $+85^{\circ}\text{C}$ up to 3.5 GHz. The measurement output voltage scales linearly in decibels with a slope of approximately 36 mV/dB.

The **ADL5903** operates from a nominal supply voltage of 3.0 V to 5.0 V. The rms core is internally regulated to 3.6 V, that is, the full measurement range is available for supply voltages between 3.8 V and 5.0 V. Below 3.8 V, the high end of the measurement range degrades gradually whereas the low end shows no noticeable change in error characteristics or calibration requirements. At 2.14 GHz, the measurement range extends to 14 dBm for 3.8 V and above, and to 12 dBm at a supply voltage of 3.0 V. The low end of the **ADL5903** measurement range is limited by internal device offsets that vary from device to device but tracks well over temperature. See the Device Calibration and Error Calculation section for more information.

The core rms processing of the **ADL5903** uses a proprietary technique that provides accuracy for complex modulation signals irrespective of the crest factor of the input signal. An integrating filter capacitor at Pin CRMS performs the square domain averaging.

An RF input matching network allows the device to be driven with a 50 Ω source with reasonable input return loss. The measurement intercept varies with frequency, as shown in Table 1 and the Typical Performance Characteristics section.

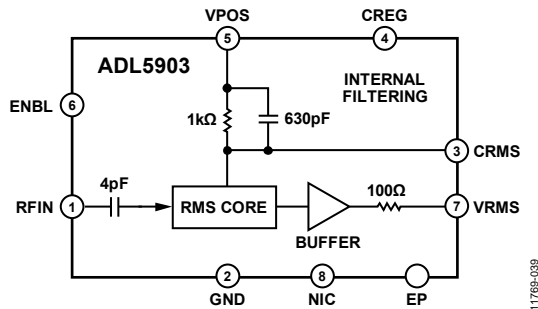

Figure 39. Simplified Architecture

RF INPUT INTERFACE

A single-ended input at the RFIN pin drives the **ADL5903**, and a 50 Ω source can drive it directly without any external components. Figure 40 shows the simplified RF input interface. An on-chip matching network presents 133 Ω of shunt resistance to ground and ac coupling to the rms core. The ESD protection circuitry is designed to allow voltage swings as high as ± 2 V at the input.

As shown in Figure 12 (input return loss, S_{11}), the device offers excellent input return loss over most of the operating range but rises to around -9 dB near its minimum operating frequency of

200 MHz. Add an external shunt resistance of 127 Ω , if desired, when operating at low frequencies to improve input return loss over the range of 200 MHz to 1.7 GHz. Figure 41 shows a comparison of the input return loss, with and without the external shunt resistor.

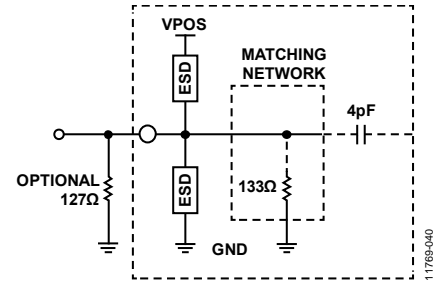

Figure 40. Simplified RF Input Interface

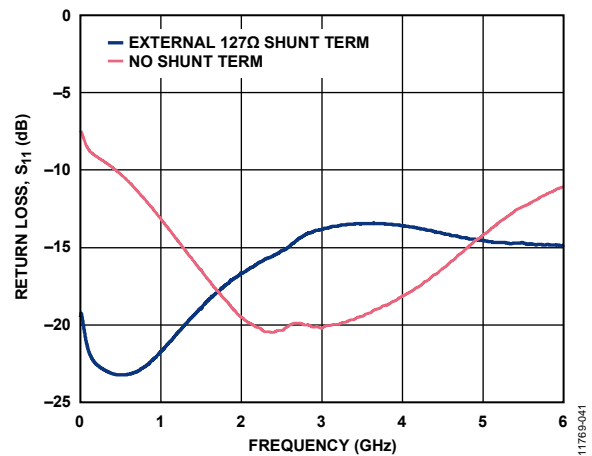

Figure 41. Return Loss with and Without External Shunt Termination

BASIC CONNECTIONS

The **ADL5903** requires a single supply of 3.0 V to 5.0 V. The supply is connected to the VPOS supply pin. This pin is decoupled using two capacitors with values equal or similar to those shown in Figure 44. Place these capacitors as near the VPOS pin as possible.

The CREG pin provides a bypass capacitor connection for an on-chip regulator. The CREG pin is connected to ground with a 4.02 Ω resistor and a 0.1 μF capacitor. The CRMS pin provides an averaging function for the rms computation and is referenced to Pin 4 (CREG). A filter capacitor can be placed between the CRMS and CREG pins. More information on choosing the C_{RMS} capacitor is provided in the Choosing a Value for C_{RMS} section. Using smaller values for C_{RMS} allows quicker response times to a pulsed waveform. Higher values of C_{RMS} are required for correct rms computation as the peak to average ratio of modulated signals increases and the bandwidth of the modulated signals decreases.

The ENBL pin configures the device enable interface. Connecting the ENBL pin to a logic high signal (2 V to 5.0 V) enables the device, and connecting the pin to a logic low signal (0 V to 0.6 V) disables the device. The exposed pad is internally connected to GND and must be soldered to a low impedance ground plane.

The output buffer of the ADL5903 features a PMOS common source drive transistor and a resistive pull-down load. Under typical operating conditions, the internal measurement range of the device limits the output signal range to ≤ 2.2 V. Place a 100 Ω resistor on chip in series with the output to allow additional filtering, if desired.

CHOOSING A VALUE FOR C_{RMS}

C_{RMS} provides the averaging function for the internal rms computation. Using the minimum value for C_{RMS} allows the quickest response time to a pulsed waveform but leaves significant output noise on the output voltage signal. However, a large filter capacitor reduces output noise and improves the rms measurement accuracy but at the expense of the response time.

In applications where the response time is not critical, place a relatively large capacitor on the CRMS pin. In Figure 44, a value of 0.1 μ F is used. For most signal modulation schemes, this value ensures excellent rms measurement compliance and low residual output noise. There is no maximum capacitance limit for C_{RMS}.

Figure 42 and Figure 43 show how output noise varies with C_{RMS} when the ADL5903 is driven by a single carrier W-CDMA (Test Model TM1-64, peak envelope power = 10.56 dB, bandwidth = 3.84 MHz) and an LTE signal (Test Model TM1-20, peak envelope power = 11.58 dB, bandwidth = 20 MHz), respectively.

Figure 42 and Figure 43 also show how the value of C_{RMS} affects the response time. This is measured by applying an RF burst at 2.14 GHz at 0 dBm to the ADL5903. The 10% to 90% rise time and 90% to 10% fall time are then measured.

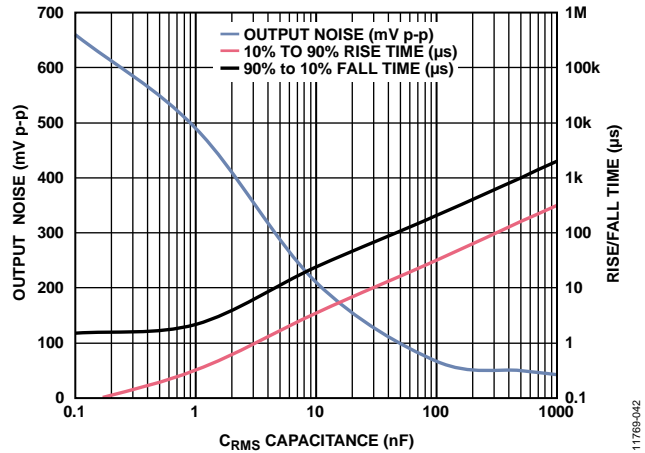

Figure 42. Output Noise, Rise/Fall Times vs. C_{RMS} Capacitance, Single Carrier W-CDMA (Test Model TM1-64) at 2.14 GHz with P_{IN} = 0 dBm

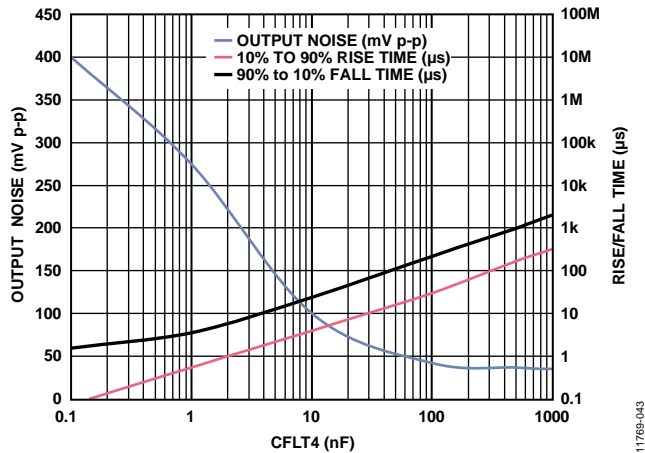

Figure 43. Output Noise, Rise/Fall Times vs. C_{RMS} Capacitance, Single Carrier LTE (Test Model TM1-20) at 2.14 GHz with P_{IN} = 0 dBm

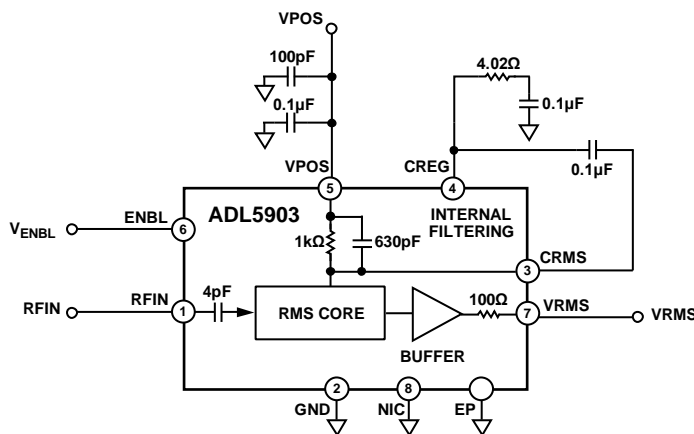

Figure 44. Basic Connections

Table 4. Recommended Minimum C_{RMS} Values for Various Modulation Schemes

Modulation/Standard	Peak Envelope Power Ratio (dB)	Carrier Bandwidth (MHz)	C _{RMSMIN} (nF)	Output Noise (mV p-p)	Rise/Fall Times (μs)
QPSK, 5 MSPS (SQR COS Filter, α = 0.35)	4.0	5	10	140	3.5/32
QPSK, 15 MSPS (SQR COS Filter, α = 0.35)	4.1	15	10	80	3.5/32
64 QAM, 1 MSPS (SQR COS Filter, α = 0.35)	7.4	1	1000	60	280/2600
64 QAM, 5 MSPS (SQR COS Filter, α = 0.35)	7.4	5	100	50	34/330
64 QAM, 13 MSPS (SQR COS Filter, α = 0.35)	7.4	13	100	50	34/330
W-CDMA, One-Carrier, TM1-64	10.56	3.84	100	80	34/330
W-CDMA Four-Carrier, TM1-64, TM1-32, TM1-16, TM1-8	12.08	18.84	100	96	34/330
LTE, TM1, One-Carrier, 20 MHz (2048 QPSK Subcarriers)	11.58	20	100	76	34/330

Table 4 shows the recommended minimum values of C_{RMS} for popular modulation schemes. The output response time and noise performance are also shown. Using lower capacitor values results in faster response times but can result in degraded rms measurement accuracy. If the output noise shown in Table 4 is unacceptably high, it can be reduced by increasing C_{RMS} or by implementing an averaging algorithm after the output voltage of the ADL5903 has been sampled by an analog-to-digital converter (ADC).

The values in Table 4 were experimentally determined to be the minimum capacitance that ensures good rms accuracy for that particular signal type. This test was initially performed with a large capacitance value on the CRMS pin (for example, 10 μF). The value of V_{RMS} was noted for a fixed input level (for example, -10 dBm). The value of C_{RMS} was then progressively reduced (this can be accomplished with press-down capacitors) until the value of V_{RMS} started to deviate from its original value (this indicates that the accuracy of the rms computation is degrading and that C_{RMS} is becoming too small).

In general, the minimum C_{RMS} required increases as the peak-to-average ratio of the carrier increases. The minimum required C_{RMS} also tends to increase as the bandwidth of the carrier decreases. With narrow-band carriers, the noise spectrum of the V_{RMS} output tends to have a correspondingly narrow profile. The relatively narrow spectral profile demands a larger value of C_{RMS} that reduces the low-pass corner frequency of the averaging function and ensures a valid rms computation.

DEVICE CALIBRATION AND ERROR CALCULATION

The measured transfer function of the ADL5903 at 2.14 GHz is shown in Figure 45, which contains plots of both output voltage and log conformance error vs. input level for one device. As the input level varies from -30 dBm to +14 dBm, the output voltage varies from near 0 V to 1.9 V.

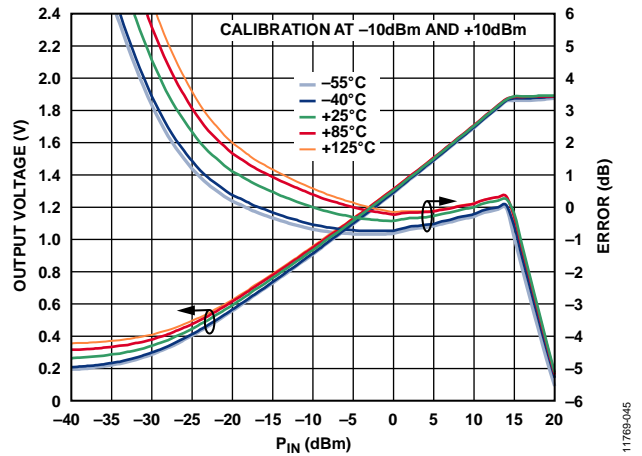

Figure 45. 2.14 GHz V_{RMS} and Log Conformance Error at +25°C, -40°C, -55°C, +85°C, and +125°C

Board level calibration must be performed to achieve high accuracy because the slope and intercept vary from device to device. For a two-point calibration, write the equation for the idealized output voltage as

$$V_{RMS(IDEAL)} = Slope \times (P_{IN} - Intercept) \tag{1}$$

where:

Slope is the change in output voltage divided by the change in input level (dBm).

P_{IN} is the input level.

Intercept is the calculated input level at which the output voltage is equal to 0 V (note that *Intercept* is an extrapolated theoretical value and not a measured value).

In general, calibration is performed during equipment manufacture by applying two or more known signal levels to the input of the ADL5903 and measuring the corresponding output voltages. The calibration points must be within the linear operating range of the device.

With a two-point calibration, calculate the slope and intercept as follows:

$$Slope = (V_{RMS1} - V_{RMS2}) / (P_{IN1} - P_{IN2}) \tag{2}$$

$$Intercept = P_{IN1} - (V_{RMS1} / Slope) \tag{3}$$

After the slope and intercept are calculated (and stored in some form) an equation can be used to calculate an unknown input level based on the output voltage of the detector.

$$P_{IN} (Unknown) = (V_{RMS(MEASURED)} / Slope) + Intercept \quad (4)$$

The log conformance error is the difference between this straight line and the actual performance of the detector.

$$Error (dB) = (V_{RMS(MEASURED)} - V_{RMS(IDEAL)}) / Slope \quad (5)$$

Figure 45 shows the log conformance error at five temperatures, ranging from -55°C to +125°C, when using a two-point calibration (calibration points are +10 dBm and -10 dBm) measured at one temperature, 25°C. The error at the two calibration points passes through 0 dB for the 25°C curve by definition.

Multipoint calibration can be used to further extend the measurement dynamic range. In this case, the transfer function is segmented, with each segment having its own slope and intercept. Figure 46 shows the error plot of the same device with calibration points at -16 dBm, -4 dBm, and +12 dBm. The three-point, dual-slope calibration results in tighter error bounds over the high end of the range and extends the lower measurement range to better than -20 dBm for ±1 dB error.

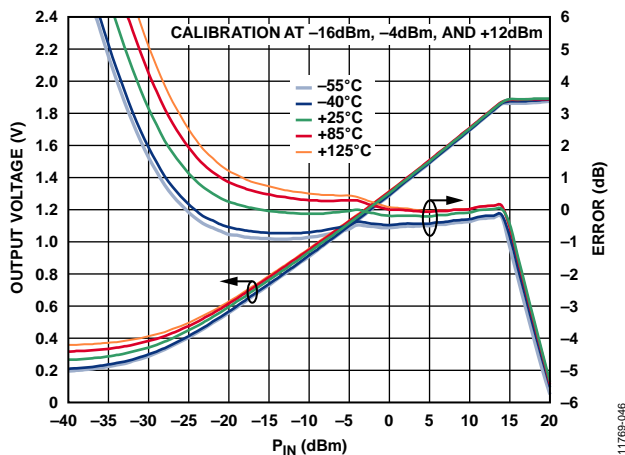

Figure 46. 2.14 GHz V_{RMS} and Log Conformance Error at +25°C, -40°C, -55°C, +85°C, and +125°C

For the example shown in Figure 46, the error drift with temperature is very small over the upper 20 dB of the measurement range, varying ±0.3 dB, but widens at lower power levels, from -20 dBm to -5 dBm to as high as ±0.9 dB. This is typical performance, although some devices may perform better.

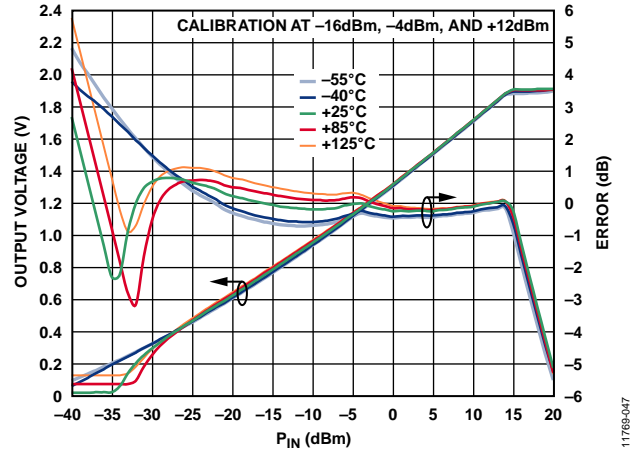

Figure 47. 2.14 GHz V_{RMS} and Log Conformance Error for Second Device at +25°C, -40°C, -55°C, +85°C, and +125°C

For comparison, the three-point calibration of a different device is shown in Figure 47 for the same frequency and calibration points. For this example, note that the device has greater dynamic range, and the temperature dependence of error at lower power levels is inverted.

Finally, Figure 48 shows the log conformance error at 2.14 GHz for a collection of four devices at +25°C, -40°C, and +85°C with three-point calibration (-16 dBm, -4 dBm, and +12 dBm). The error plots at each temperature are calculated with respect to the slope and intercept measurements from the 25°C line for each device. This is consistent with a typical production environment where calibration at one temperature is required. Figure 48 illustrates the various error scenarios possible at low input levels. The dynamic range of the three-point calibrated devices extends to below -20 dBm for ±1.0 dB error.

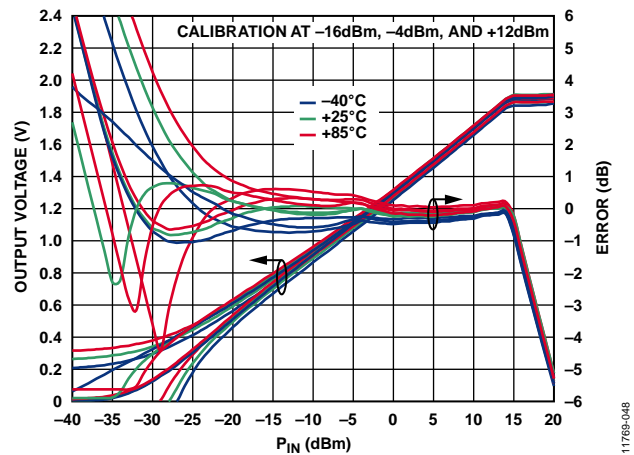

Figure 48. 2.14 GHz V_{RMS} and Log Conformance +25°C, -40°C, and +85°C for Multiple Devices

EVALUATION BOARD SCHEMATIC AND CONFIGURATION OPTIONS

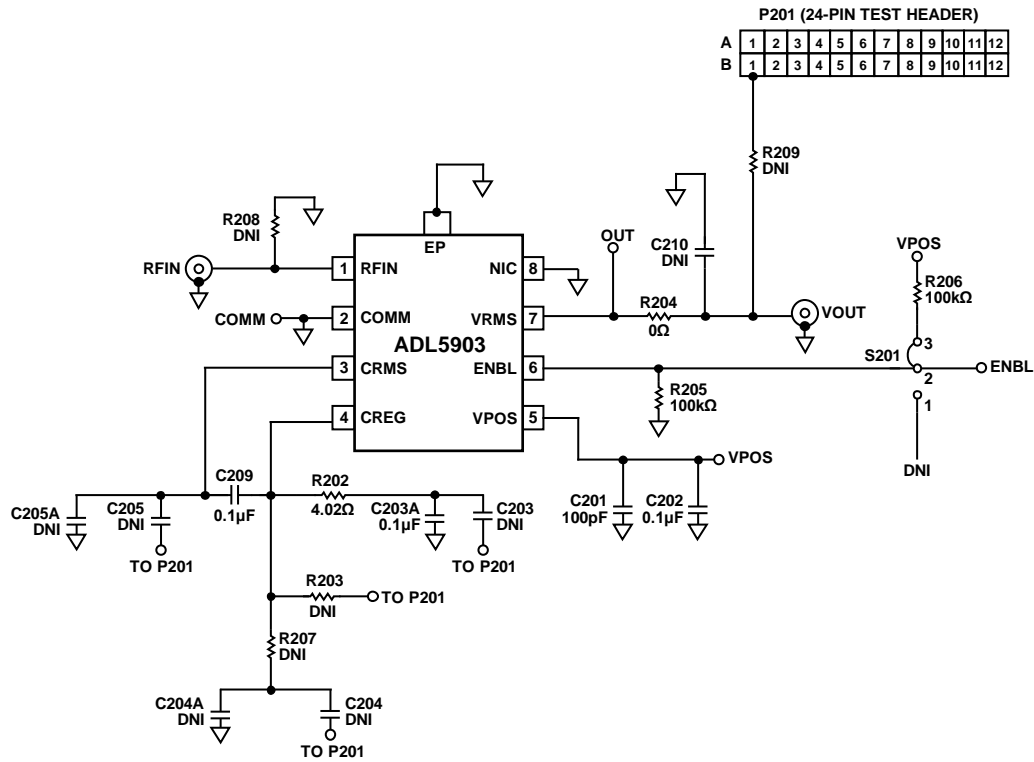

Figure 49. Evaluation Board Schematic

11769-049

Table 5. Evaluation Board Configuration Options

Component	Description	Default Value
RFIN, R208	RF input. R208 is a shunt input termination to optimize low frequency input return loss.	RFIN = SMA connector, R208 = DNI ¹
R205, R206, S201	Device enable interface. Header S201 configures the enable network. Pin 2 and Pin 3 of S201 enable the resistive divider network. R205 and R206 form a resistive divider network to step down the voltage provided by VPOS for an optimal enable setpoint condition.	R205 = 100 kΩ, R206 = 100 kΩ, S201 = Jumper Pin 2 and Jumper Pin 3
C201, C202	Power supply decoupling. The nominal supply decoupling consists of a 100 pF and a 0.1 µF capacitor placed near the device.	C201 = 100 pF, C202 = 0.1 µF
C209	RMS averaging capacitor. C209 is the capacitor (C _{RMS}) interfacing CREG and CRMS for rms averaging. Set the value of the rms averaging capacitor on the peak-to-average ratio of the input signal and based on the desired output response time and residual output noise. See the Choosing a Value for C _{RMS} section for more information.	C209 = 0.1 µF
R202, C203A	Bypass capacitor connection for on-chip regulator. R202 and C203A are connected to the CREG pin to provide decoupling for the internal regulator.	R202 = 4.02 Ω, C203A = 0.1 µF
R204, C210	RMS output. R204 and C210 provide options for output filtering and to mimic system load conditions.	R204 = 0 Ω, C210 = DNI ¹
C203, C204, C204A, C205, C205A, R203, R207, R209	Test header interface.	C203, C204, C204A, C205, C205A, R203, R207, R208, R209 = DNI ¹
EP	Exposed pad. The exposed pad is soldered to a ground pad, which provides both a thermal ground and an electrical ground.	

¹ DNI = do not install.

OUTLINE DIMENSIONS

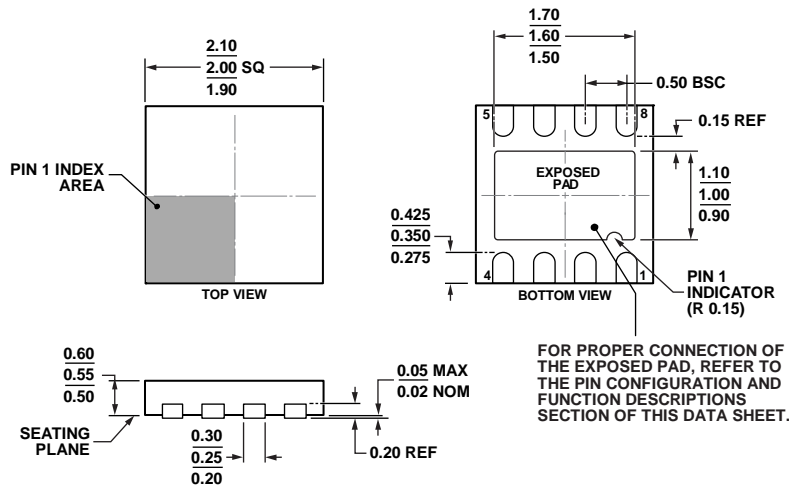

Figure 50. 8-Lead Lead Frame Chip Scale Package [LFCSP_UD]
 2.00 mm × 2.00 mm Body, Ultra Thin, Dual Lead
 (CP-8-10)
 Dimensions shown in millimeters

ORDERING GUIDE

Model ¹	Temperature Range	Package Description	Package Option	Branding	Ordering Quantity
ADL5903ACPZN-R7	-40°C to +85°C	8-Lead LFCSP_UD, 7" Tape and Reel	CP-8-10	BS	3,000
ADL5903SCPZN-R7	-55°C to +125°C	8-Lead LFCSP_UD, 7" Tape and Reel	CP-8-10	CJ	3,000
ADL5903-EVALZ		Evaluation Board			

¹ Z = RoHS Compliant Part.

Mouser Electronics

Authorized Distributor

Click to View Pricing, Inventory, Delivery & Lifecycle Information:

[Analog Devices Inc.:](#)

[ADL5903SCPZN-R7](#) [ADL5903-EVALZ](#) [ADL5903ACPZN-R7](#)