

# RIF-1-RSC-LDP-24DC/2X21 - Relay Module



2903350

<https://www.phoenixcontact.com/us/products/2903350>

Please be informed that the data shown in this PDF document is generated from our online catalog. Please find the complete data in the user documentation. Our general terms of use for downloads are valid.



Preassembled relay module with screw connection, consisting of: relay base, power contact relay, plug-in display/interference suppression module, and retaining bracket. Contact switching type: 2 changeover contacts. Input voltage: 24 V DC

## Product description

The pluggable electromechanical and solid-state relays in the RIFLINE complete product range and the base are recognized and approved in accordance with UL 508. The relevant approvals can be called up at the individual components in question.

## Commercial data

Item number	2903350
Packing unit	10 pc
Minimum order quantity	10 pc
Sales key	C465
Product key	CK6519
Catalog page	Page 329 (C-5-2019)
GTIN	4046356732130
Weight per piece (including packing)	70.15 g
Weight per piece (excluding packing)	70 g
Customs tariff number	85364190
Country of origin	CN

# RIF-1-RSC-LDP-24DC/2X21 - Relay Module



2903350

<https://www.phoenixcontact.com/us/products/2903350>

## Set consists of

### RIF-1-BSC/2X21 - Relay base

2900930

<https://www.phoenixcontact.com/us/products/2900930>



RIF-1... relay base, for miniature power relay with 1 or 2 changeover contacts or identical solid-state relays, screw connection, plug-in option for input/interference suppression modules, for mounting on NS 35/7,5

---

### REL-MR- 24DC/21-21 - Single relay

2961192

<https://www.phoenixcontact.com/us/products/2961192>

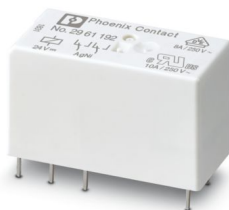

Plug-in miniature power relay, with power contact, 2 changeover contacts, input voltage 24 V DC

# RIF-1-RSC-LDP-24DC/2X21 - Relay Module



2903350

<https://www.phoenixcontact.com/us/products/2903350>

## RIF-LDP-12-24 DC - Plug-in module

2900939

<https://www.phoenixcontact.com/us/products/2900939>



Plug-in module, for mounting on RIF-1, RIF-2, RIF-3, and RIF-4, with freewheeling diode and yellow LED, polarity: A1+, A2-, input voltage: 12 V DC ... 24 V DC  $\pm 30\%$

---

## RIF-RH-1 - Retaining bracket

2900953

<https://www.phoenixcontact.com/us/products/2900953>



Relay retaining bracket, with ejector function and holder for marking material, suitable for RIF-1 relay base, for 16 mm tall miniature power relay and solid-state relay

# RIF-1-RSC-LDP-24DC/2X21 - Relay Module



2903350

<https://www.phoenixcontact.com/us/products/2903350>

## Technical data

### Notes

General	FBS 2-6... plug-in bridge for the input side (A2) and FBS-2-8... plug-in bridge for the output side (11/21)
---------	---

### Product properties

Product type	Relay Module
Product family	RIFLINE complete
Application	Universal
Operating mode	100% operating factor
Mechanical service life	approx. $3 \times 10^7$ cycles

### Insulation characteristics

Insulation	Safe isolation between input and output
	Basic insulation between the changeover contacts

### Insulation characteristics

Insulation	Safe isolation between input and output
	Basic insulation between the changeover contacts
Overvoltage category	III
Pollution degree	2

### Electrical properties

Service life electrical	see diagram
Maximum power dissipation for nominal condition	0.43 W
Test voltage (Winding/contact)	4 kV <sub>rms</sub> (50 Hz, 1 min., winding/contact)
Test voltage (Changeover contact/changeover contact)	2.5 kV <sub>rms</sub> (50 Hz, 1 min., changeover contact/changeover contact)
Rated insulation voltage	250 V AC
Rated surge voltage	6 kV (Input/output)
	4 kV (between the changeover contacts)

### Input data

#### Coil side

Nominal input voltage $U_N$	24 V DC
Input voltage range	19.2 V DC ... 33.6 V DC (20 °C)
Input voltage range in reference to $U_N$	see diagram
Drive and function	monostable
Drive (polarity)	polarized
Typical input current at $U_N$	18 mA
Typical response time	8 ms
Typical release time	10 ms
Coil voltage	24 V DC

# RIF-1-RSC-LDP-24DC/2X21 - Relay Module



2903350

<https://www.phoenixcontact.com/us/products/2903350>

Protective circuit	Freewheeling diode
Operating voltage display	Yellow LED

## Output data

### Switching

Contact switching type	2 changeover contacts
Type of switch contact	Single contact
Contact material	AgNi
Maximum switching voltage	250 V AC/DC
Minimum switching voltage	5 V (10 mA)
Limiting continuous current	8 A (see diagram)
Maximum inrush current	25 A (20 ms, N/O contacts)
Min. switching current	10 mA (5 V)
Interrupting rating (ohmic load) max.	192 W (at 24 V DC) 96 W (at 48 V DC) 60 W (at 60 V DC) 44 W (at 110 V DC) 57 W (at 220 V DC) 2000 VA (for 250 V AC)
Utilization category CB Scheme (IEC 60947-5-1)	AC15, 1.5 A/240 V (N/O contact) AC15, 2 A/250 V (N/C contact) DC13, 2 A/24 V (N/C contact) DC13, 0.2 A/250 V (N/O contact)

## Connection data

Connection method	Screw connection
Stripping length	8 mm
Conductor cross section rigid	0.5 mm <sup>2</sup> ... 4 mm <sup>2</sup>
Conductor cross-section rigid (2 conductors with same cross section)	0.5 mm <sup>2</sup> ... 2.5 mm <sup>2</sup>
Conductor cross section flexible	0.5 mm <sup>2</sup> ... 4 mm <sup>2</sup> 0.5 mm <sup>2</sup> ... 4 mm <sup>2</sup> (Ferrule with plastic sleeve)
Conductor cross section flexible (2 conductors with same cross section)	0.5 mm <sup>2</sup> ... 2.5 mm <sup>2</sup> 0.5 mm <sup>2</sup> ... 1.5 mm <sup>2</sup> (TWIN ferrule with plastic sleeve)
Conductor cross section AWG	20 ... 10 (solid) 20 ... 12 (flexible)
Tightening torque	0.5 Nm ... 0.6 Nm

## Dimensions

Width	16 mm
Height	90 mm
Depth	75 mm

## Material specifications

# RIF-1-RSC-LDP-24DC/2X21 - Relay Module



2903350

<https://www.phoenixcontact.com/us/products/2903350>

Color	gray (RAL 7042)
Flammability rating according to UL 94	V2 (Housing)

## Environmental and real-life conditions

### Ambient conditions

Degree of protection (Relay base)	IP20 (Relay base)
Degree of protection (Relay)	RT III (Relay)
Ambient temperature (operation)	-40 °C ... 70 °C
Ambient temperature (storage/transport)	-40 °C ... 85 °C

## Approvals

### Corrosive gas test

Identification	ISA-S71.04. G3 Harsh Group
	EN 60068-2-60

## Standards and regulations

Standards/regulations	IEC 60947-5-1
-----------------------	---------------

## Mounting

Mounting type	DIN rail mounting
Assembly instructions	in rows with zero spacing
Mounting position	any

Drawings

Circuit diagram

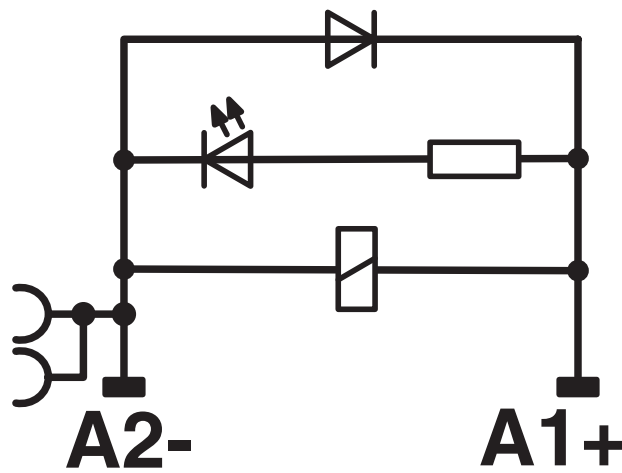
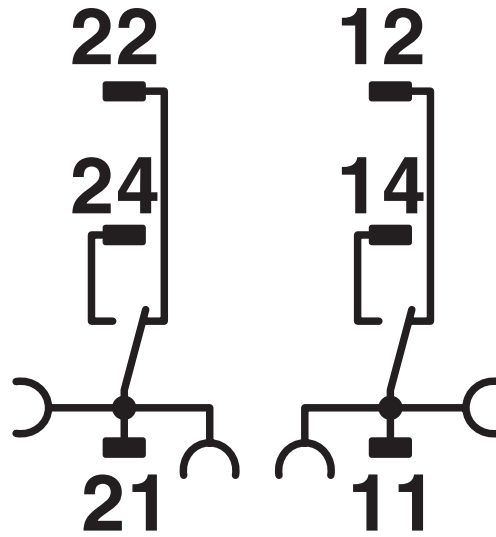

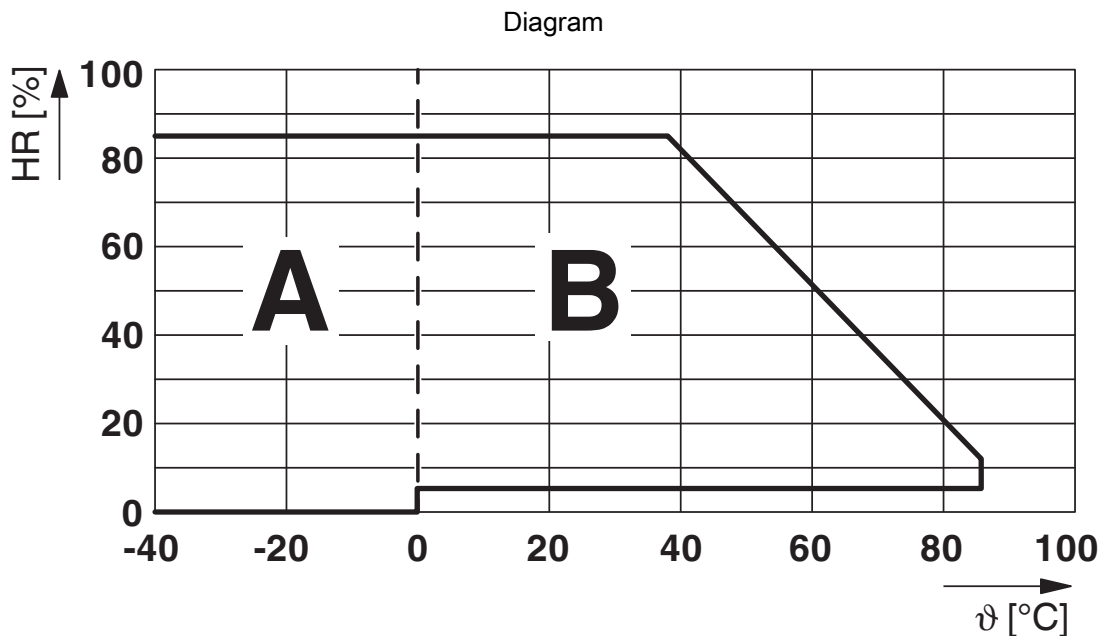

Permissible humidity for operation and storage.

The maximum permissible ambient temperature as specified in the data sheet must be observed.

Area A: Ice buildup at ambient temperatures  $\leq 0^\circ\text{C}$  must be prevented

Area B: Condensation at ambient temperatures  $> 0^\circ\text{C}$  must be prevented

On 30 full days that are naturally distributed across an entire year, a humidity level of 95% is permissible at an ambient temperature  $\leq 25^\circ\text{C}$ .



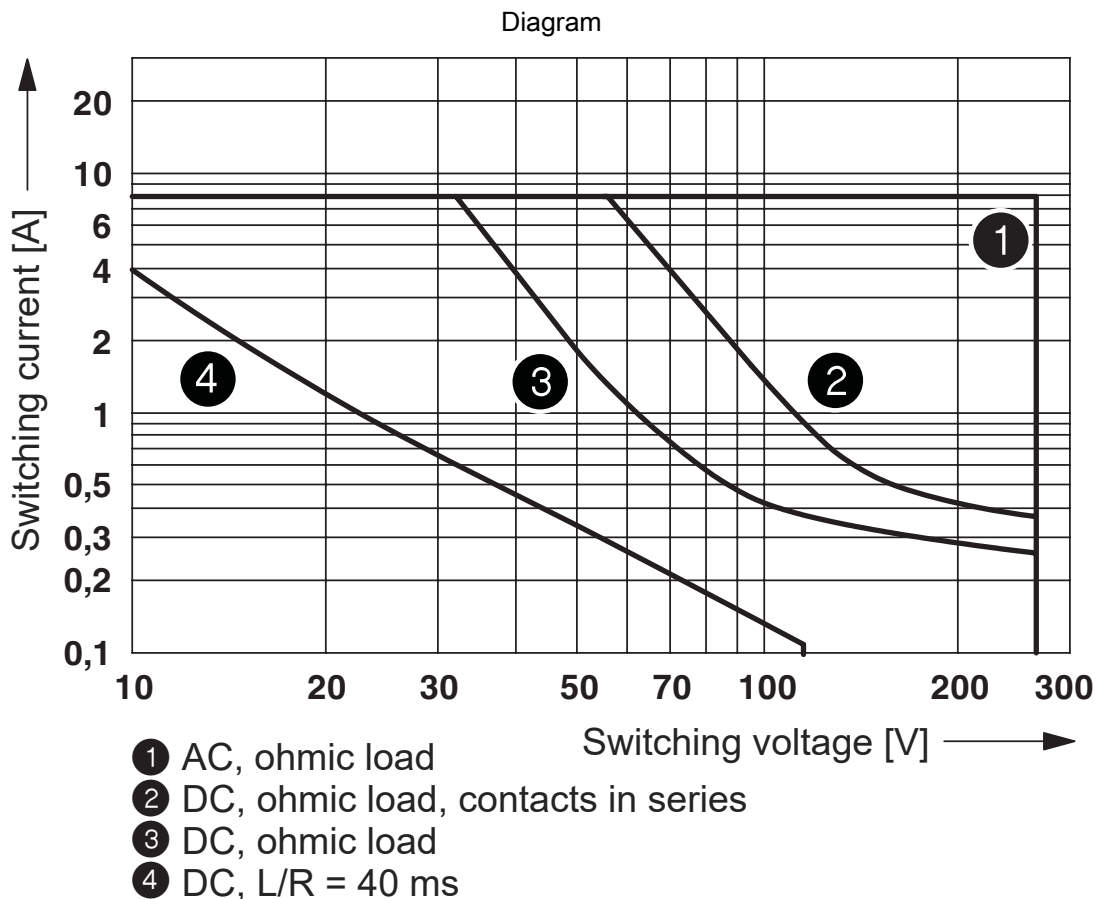

Interrupting rating

Diagram

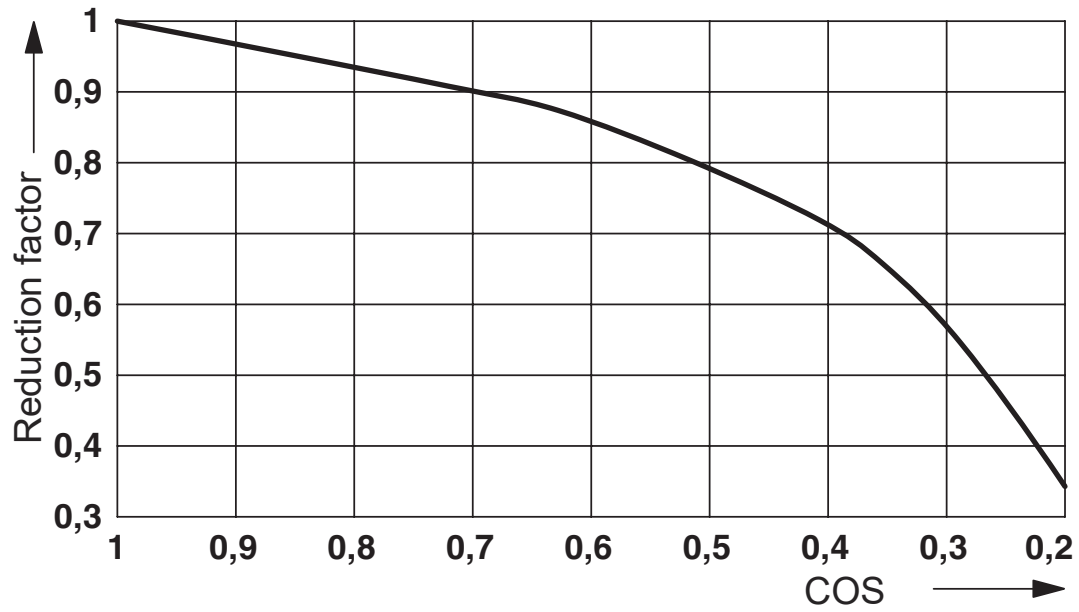

Service life reduction factor

Diagram

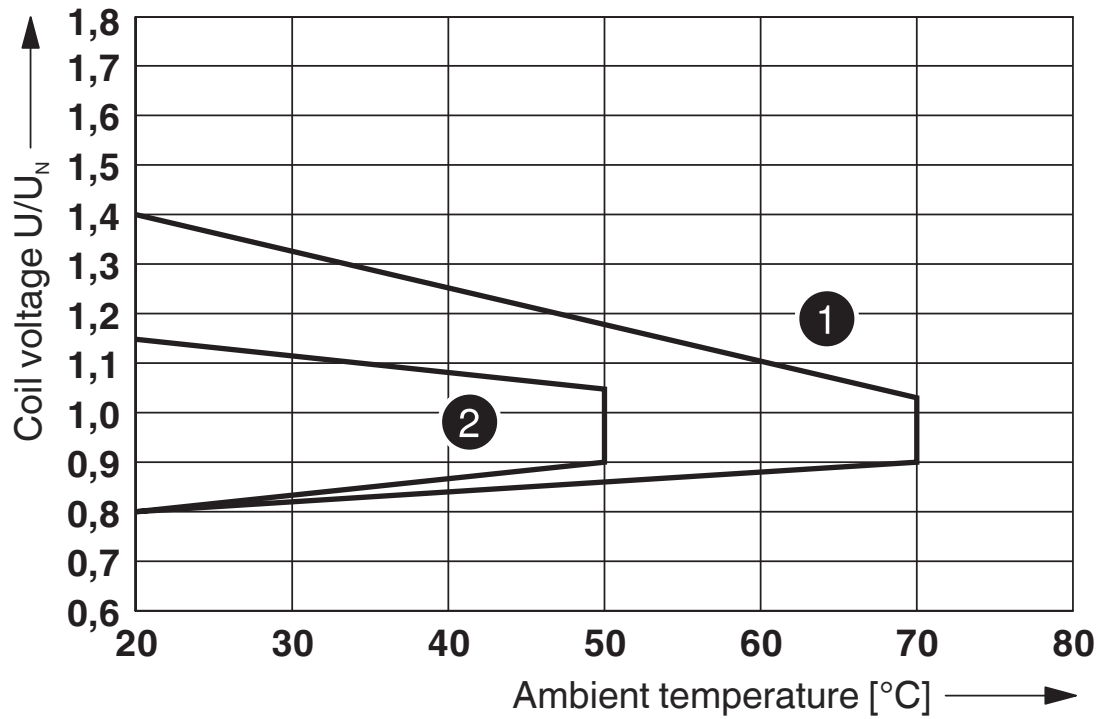

- ① DC coils
- ② AC coils

Operating voltage range

Diagram

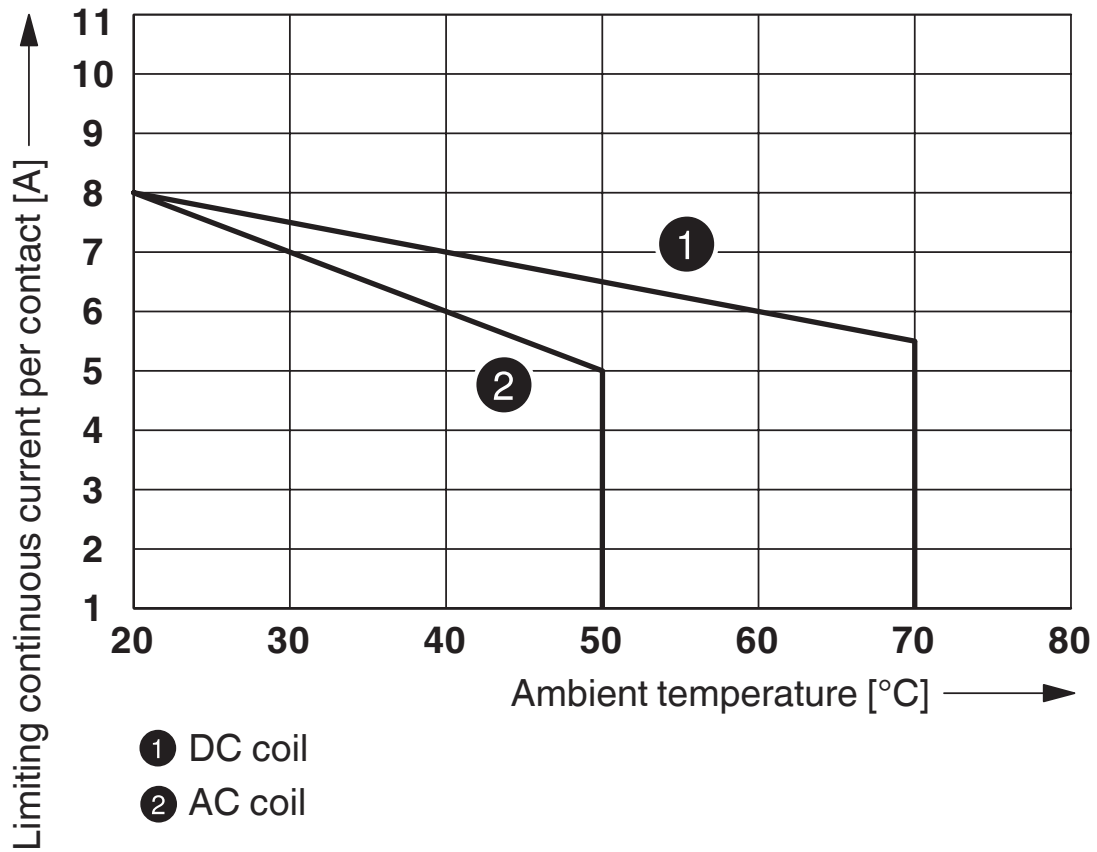

Contact derating

2903350

<https://www.phoenixcontact.com/us/products/2903350>

Diagram

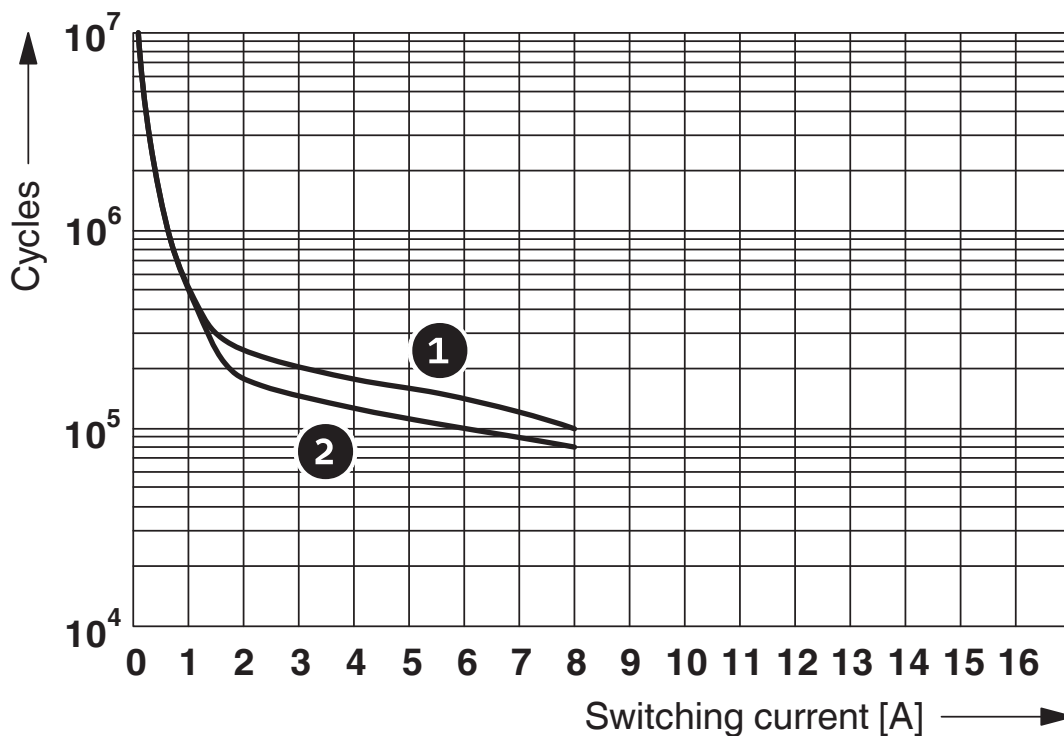

- ① 250 V AC, ohmic load (DC coils)
- ② 250 V AC, ohmic load (AC coils)

Electrical service life

# RIF-1-RSC-LDP-24DC/2X21 - Relay Module



2903350

<https://www.phoenixcontact.com/us/products/2903350>

## Approvals

To download certificates, visit the product detail page: <https://www.phoenixcontact.com/us/products/2903350>



**EAC**

Approval ID: TR\_TS\_D\_00573\_c



**DNV GL**

Approval ID: TAA000018V

# RIF-1-RSC-LDP-24DC/2X21 - Relay Module



2903350

<https://www.phoenixcontact.com/us/products/2903350>

## Classifications

### ECLASS

ECLASS-11.0	27371601
ECLASS-12.0	27371601
ECLASS-13.0	27371601

### ETIM

ETIM 9.0	EC001437
----------	----------

### UNSPSC

UNSPSC 21.0	39122300
-------------	----------

2903350

<https://www.phoenixcontact.com/us/products/2903350>

## Environmental product compliance

### EU RoHS

Fulfills EU RoHS substance requirements	Yes
Exemption	7(a), 7(c)-I

### China RoHS

Environment friendly use period (EFUP)	EFUP-50
	An article-related China RoHS declaration table can be found in the download area for the respective article under "Manufacturer declaration". For all articles with EFUP-E, no China RoHS declaration table issued and required.

### EU REACH SVHC

REACH candidate substance (CAS No.)	Lead(CAS: 7439-92-1)
SCIP	44f8f726-29d1-4b9a-a5ea-0b9f5f376dec

### EF3.0 Climate Change

CO2e kg	0.86 kg CO2e
---------	--------------



# RIF-1-RSC-LDP-24DC/2X21 - Relay Module



2903350

<https://www.phoenixcontact.com/us/products/2903350>

## Accessories

### FBS 2-6 - Plug-in bridge

3030336

<https://www.phoenixcontact.com/us/products/3030336>



Plug-in bridge, pitch: 6.2 mm, number of positions: 2, color: red

---

### FBS 2-6 BU - Plug-in bridge

3036932

<https://www.phoenixcontact.com/us/products/3036932>



Plug-in bridge, pitch: 6.2 mm, number of positions: 2, color: blue

# RIF-1-RSC-LDP-24DC/2X21 - Relay Module



2903350

<https://www.phoenixcontact.com/us/products/2903350>

## FBS 2-6 GY - Plug-in bridge

3032237

<https://www.phoenixcontact.com/us/products/3032237>



Plug-in bridge, pitch: 6.2 mm, number of positions: 2, color: gray

---

## FBS 2-8 - Plug-in bridge

3030284

<https://www.phoenixcontact.com/us/products/3030284>



Plug-in bridge, pitch: 8.2 mm, number of positions: 2, color: red

# RIF-1-RSC-LDP-24DC/2X21 - Relay Module



2903350

<https://www.phoenixcontact.com/us/products/2903350>

## FBS 2-8 BU - Plug-in bridge

3032567

<https://www.phoenixcontact.com/us/products/3032567>



Plug-in bridge, pitch: 8.2 mm, number of positions: 2, color: blue

---

## FBS 2-8 GY

## 7042 - Plug-in bridge

3032541

<https://www.phoenixcontact.com/us/products/3032541>



Bridge for potential distribution

# RIF-1-RSC-LDP-24DC/2X21 - Relay Module



2903350

<https://www.phoenixcontact.com/us/products/2903350>

## STP 5-2 - Marker carriers

0800967

<https://www.phoenixcontact.com/us/products/0800967>



Marker carriers, snaps into STTB 2,5, STTB 4, PTTB 2,5, and PTTB 4 double-level spring-cage terminal blocks, can be marked with UC-TM 5, UC-TMF 5, UCT-TM 5, UCT-TMF 5, ZB 5, or ZBF 5, gray, unlabeled, mounting type: plug in, lettering field size: 5 x 10.5 mm

---

## RIF-1-V8/PT/FLK14/OUT - System connection

2905195

<https://www.phoenixcontact.com/us/products/2905195>



V8 adapter for 8 x RIF-1 relay base, controller: PLC system cabling of output cards, connection 1: Push-in connection 4x, connection 2: IDC/FLK pin strip 1x 14-position, connection 3: Plug-in connection, number of channels: 8, control logic: plusschaltend

# RIF-1-RSC-LDP-24DC/2X21 - Relay Module



2903350

<https://www.phoenixcontact.com/us/products/2903350>

## NS 35/ 7,5 PERF 2000MM - DIN rail perforated

0801733

<https://www.phoenixcontact.com/us/products/0801733>



DIN rail perforated, Pack of 25 (50 m), acc. to EN 60715, material: Steel, galvanized, passivated with a thick layer, Standard profile, color: silver

---

## NS 35/ 7,5 UNPERF 2000MM - DIN rail, unperforated

0801681

<https://www.phoenixcontact.com/us/products/0801681>



DIN rail, unperforated, Pack of 25 (50 m), acc. to EN 60715, material: Steel, galvanized, passivated with a thick layer, Standard profile, color: silver

# RIF-1-RSC-LDP-24DC/2X21 - Relay Module



2903350

<https://www.phoenixcontact.com/us/products/2903350>

## NS 35/ 7,5 WH PERF 2000MM - DIN rail perforated

1204119

<https://www.phoenixcontact.com/us/products/1204119>



DIN rail perforated, Pack of 25 (50 m), acc. to EN 60715, material: Steel, Galvanized, white passivated, Standard profile, color: silver

---

## NS 35/ 7,5 WH UNPERF 2000MM-VPE 10 - DIN rail, unperforated

1204122

<https://www.phoenixcontact.com/us/products/1204122>



DIN rail, unperforated, Pack of 10 (20 m), acc. to EN 60715, material: Steel, Galvanized, white passivated, Standard profile, color: silver

# RIF-1-RSC-LDP-24DC/2X21 - Relay Module



2903350

<https://www.phoenixcontact.com/us/products/2903350>

## NS 35/ 7,5 AL UNPERF 2000MM - DIN rail, unperforated

0801704

<https://www.phoenixcontact.com/us/products/0801704>



DIN rail, unperforated, Pack of 25 (50 m), acc. to EN 60715, material: Aluminum, uncoated, Standard profile, color: silver

---

## NS 35/ 7,5 ZN PERF 2000MM - DIN rail perforated

1206421

<https://www.phoenixcontact.com/us/products/1206421>



DIN rail perforated, Pack of 25 (50 m), acc. to EN 60715, material: Steel, galvanized, Standard profile, color: silver

# RIF-1-RSC-LDP-24DC/2X21 - Relay Module



2903350

<https://www.phoenixcontact.com/us/products/2903350>

## NS 35/ 7,5 ZN UNPERF 2000MM - DIN rail, unperforated

1206434

<https://www.phoenixcontact.com/us/products/1206434>



DIN rail, unperforated, Pack of 25 (50 m), acc. to EN 60715, material: Steel, galvanized, Standard profile, color: silver

---

## NS 35/ 7,5 CU UNPERF 2000MM-VPE 10 - DIN rail, unperforated

0801762

<https://www.phoenixcontact.com/us/products/0801762>



DIN rail, unperforated, Pack of 10 (20 m), acc. to EN 60715, material: Copper, uncoated, Standard profile, color: copper-colored



# RIF-1-RSC-LDP-24DC/2X21 - Relay Module



2903350

<https://www.phoenixcontact.com/us/products/2903350>

## NS 35/ 7,5 CAP - End cap

1206560

<https://www.phoenixcontact.com/us/products/1206560>

DIN rail end piece, for DIN rail NS 35/7.5



---

## NS 35/15 PERF 2000MM - DIN rail perforated

1201730

<https://www.phoenixcontact.com/us/products/1201730>



DIN rail perforated, Pack of 25 (50 m), similar to EN 60715, material: Steel, galvanized, passivated with a thick layer, Standard profile, color: silver

# RIF-1-RSC-LDP-24DC/2X21 - Relay Module



2903350

<https://www.phoenixcontact.com/us/products/2903350>

## NS 35/15 UNPERF 2000MM - DIN rail, unperforated

1201714

<https://www.phoenixcontact.com/us/products/1201714>



DIN rail, unperforated, Pack of 25 (50 m), similar to EN 60715, material: Steel, galvanized, passivated with a thick layer, Standard profile, color: silver

---

## NS 35/15 WH PERF 2000MM - DIN rail perforated

0806602

<https://www.phoenixcontact.com/us/products/0806602>



DIN rail perforated, Pack of 25 (50 m), similar to EN 60715, material: Steel, Galvanized, white passivated, Standard profile, color: white

# RIF-1-RSC-LDP-24DC/2X21 - Relay Module



2903350

<https://www.phoenixcontact.com/us/products/2903350>

## NS 35/15 WH UNPERF 2000MM-VPE 10 - DIN rail, unperforated

1204135

<https://www.phoenixcontact.com/us/products/1204135>



DIN rail, unperforated, Pack of 10 (20 m), similar to EN 60715, material: Steel, Galvanized, white passivated, Standard profile, color: silver

---

## NS 35/15 AL UNPERF 2000MM - DIN rail, unperforated

1201756

<https://www.phoenixcontact.com/us/products/1201756>



DIN rail, unperforated, similar to EN 60715, material: Aluminum, uncoated, Standard profile, color: silver

# RIF-1-RSC-LDP-24DC/2X21 - Relay Module



2903350

<https://www.phoenixcontact.com/us/products/2903350>

## NS 35/15 ZN PERF 2000MM - DIN rail perforated

1206599

<https://www.phoenixcontact.com/us/products/1206599>



DIN rail perforated, Pack of 25 (50 m), similar to EN 60715, material: Steel, galvanized, Standard profile, color: silver

---

## NS 35/15 ZN UNPERF 2000MM - DIN rail, unperforated

1206586

<https://www.phoenixcontact.com/us/products/1206586>



DIN rail, unperforated, Pack of 25 (50 m), similar to EN 60715, material: Steel, galvanized, Standard profile, color: silver

# RIF-1-RSC-LDP-24DC/2X21 - Relay Module



2903350

<https://www.phoenixcontact.com/us/products/2903350>

## NS 35/15 CU UNPERF 2000MM-VPE 10 - DIN rail, unperforated

1201895

<https://www.phoenixcontact.com/us/products/1201895>



DIN rail, unperforated, Pack of 10 (20 m), similar to EN 60715, material: Copper, uncoated, Standard profile, color: copper-colored

---

## NS 35/15 CAP - End cap

1206573

<https://www.phoenixcontact.com/us/products/1206573>

DIN rail end piece, for DIN rail NS 35/15



# RIF-1-RSC-LDP-24DC/2X21 - Relay Module

2903350

<https://www.phoenixcontact.com/us/products/2903350>



## NS 35/15-2,3 UNPERF 2000MM-VPE 10 - DIN rail, unperforated

1201798

<https://www.phoenixcontact.com/us/products/1201798>



DIN rail, unperforated, Pack of 10 (20 m), acc. to EN 60715, material: Steel, galvanized, passivated with a thick layer, Standard profile 2.3 mm, color: silver

---

## MPS-MT - Test plug

0201744

<https://www.phoenixcontact.com/us/products/0201744>



Test plug, with solder connection up to 1 mm<sup>2</sup> conductor cross section, number of positions: 1, color: gray

# RIF-1-RSC-LDP-24DC/2X21 - Relay Module



2903350

<https://www.phoenixcontact.com/us/products/2903350>

## MPS-IH WH - Insulating sleeve

0201663

<https://www.phoenixcontact.com/us/products/0201663>

Insulating sleeve, color: white



---

## MPS-IH RD - Insulating sleeve

0201676

<https://www.phoenixcontact.com/us/products/0201676>

Insulating sleeve, color: red



# RIF-1-RSC-LDP-24DC/2X21 - Relay Module



2903350

<https://www.phoenixcontact.com/us/products/2903350>

## MPS-IH BU - Insulating sleeve

0201689

<https://www.phoenixcontact.com/us/products/0201689>

Insulating sleeve, color: blue

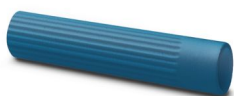

---

## MPS-IH YE - Insulating sleeve

0201692

<https://www.phoenixcontact.com/us/products/0201692>

Insulating sleeve, color: yellow





# RIF-1-RSC-LDP-24DC/2X21 - Relay Module



2903350

<https://www.phoenixcontact.com/us/products/2903350>

## MPS-IH GN - Insulating sleeve

0201702

<https://www.phoenixcontact.com/us/products/0201702>

Insulating sleeve, color: green



---

## MPS-IH GY - Insulating sleeve

0201728

<https://www.phoenixcontact.com/us/products/0201728>

Insulating sleeve, color: gray



# RIF-1-RSC-LDP-24DC/2X21 - Relay Module



2903350

<https://www.phoenixcontact.com/us/products/2903350>

## MPS-IH BK - Insulating sleeve

0201731

<https://www.phoenixcontact.com/us/products/0201731>

Insulating sleeve, color: black



---

## ZB 5 :UNBEDRUCKT - Zack marker strip

1050004

<https://www.phoenixcontact.com/us/products/1050004>



Zack marker strip, Strip, white, unlabeled, can be labeled with: PLOTMARK, CMS-P1-PLOTTER, mounting type: snapped, for terminal block width: 5.2 mm, lettering field size: 5.1 x 10.5 mm, Number of individual labels: 10

# RIF-1-RSC-LDP-24DC/2X21 - Relay Module



2903350

<https://www.phoenixcontact.com/us/products/2903350>

## ZB 5 CUS - Zack marker strip

0824962

<https://www.phoenixcontact.com/us/products/0824962>



Zack marker strip, can be ordered: Strip, white, labeled according to customer specifications, mounting type: snap into tall marker groove, for terminal block width: 5.2 mm, lettering field size: 5.15 x 10.5 mm, Number of individual labels: 10

---

## ZB 5,LGS:FORTL.ZAHLEN - Zack marker strip

1050017

<https://www.phoenixcontact.com/us/products/1050017>



Zack marker strip, Strip, white, labeled, printed horizontally: consecutive numbers 1 ... 10, 11 ... 20, etc. up to 491 ... 500, mounting type: snapped, for terminal block width: 5.2 mm, lettering field size: 5.15 x 10.5 mm, Number of individual labels: 10

# RIF-1-RSC-LDP-24DC/2X21 - Relay Module



2903350

<https://www.phoenixcontact.com/us/products/2903350>

## ZB 5,QR:FORTL.ZAHLEN - Zack marker strip

1050020

<https://www.phoenixcontact.com/us/products/1050020>



Zack marker strip, white, Printed vertically: consecutive numbers 1 ... 10, 11 ... 20, etc. up to 491 ... 500, mounting type: snapped, for terminal block width: 5.2 mm, lettering field size: 5.15 x 10.5 mm

---

## ZB 5,LGS:GLEICHE ZAHLEN - Zack marker strip

1050033

<https://www.phoenixcontact.com/us/products/1050033>



Zack marker strip, Strip, white, labeled, can be labeled with: CMS-P1-PLOTTER, printed horizontally: Identical numbers 1 or 2, etc. up to 100, mounting type: snapped, for terminal block width: 5.2 mm, lettering field size: 5.15 x 10.5 mm, Number of individual labels: 10

# RIF-1-RSC-LDP-24DC/2X21 - Relay Module



2903350

<https://www.phoenixcontact.com/us/products/2903350>

## ZB 5,LGS:L1-N,PE - Zack marker strip

1050415

<https://www.phoenixcontact.com/us/products/1050415>



Zack marker strip, Strip, white, labeled, horizontal: L1, L2, L3, N, PE, L1, L2, L3, N, PE, mounting type: snapped, for terminal block width: 5.2 mm, lettering field size: 5.15 x 10.5 mm, Number of individual labels: 10

---

## UC-TM 5 - Marker for terminal blocks

0818108

<https://www.phoenixcontact.com/us/products/0818108>



Marker for terminal blocks, Sheet, white, unlabeled, can be labeled with: BLUEMARK ID COLOR, BLUEMARK ID, BLUEMARK CLED, PLOTMARK, CMS-P1-PLOTTER, mounting type: snapped, for terminal block width: 5.2 mm, lettering field size: 4.6 x 10.5 mm, Number of individual labels: 96

# RIF-1-RSC-LDP-24DC/2X21 - Relay Module



2903350

<https://www.phoenixcontact.com/us/products/2903350>

## UC-TM 5 CUS - Marker for terminal blocks

0824581

<https://www.phoenixcontact.com/us/products/0824581>



Marker for terminal blocks, can be ordered: by sheet, white, labeled according to customer specifications, mounting type: snap into tall marker groove, for terminal block width: 5.2 mm, lettering field size: 10.5 x 4.6 mm, Number of individual labels: 96

---

## UCT-TM 5 - Marker for terminal blocks

0828734

<https://www.phoenixcontact.com/us/products/0828734>



Marker for terminal blocks, Sheet, white, unlabeled, can be labeled with: TOPMARK NEO, TOPMARK LASER, BLUEMARK ID COLOR, BLUEMARK ID, BLUEMARK CLED, THERMOMARK PRIME, THERMOMARK CARD 2.0, THERMOMARK CARD, mounting type: snapped, for terminal block width: 5.2 mm, lettering field size: 4.6 x 10.5 mm, Number of individual labels: 72

# RIF-1-RSC-LDP-24DC/2X21 - Relay Module



2903350

<https://www.phoenixcontact.com/us/products/2903350>

## UCT-TM 5 CUS - Marker for terminal blocks

0829595

<https://www.phoenixcontact.com/us/products/0829595>



Marker for terminal blocks, can be ordered: by sheet, white, labeled according to customer specifications, mounting type: snap into tall marker groove, for terminal block width: 5.2 mm, lettering field size: 4.6 x 10.5 mm, Number of individual labels: 72

---

## GBS 5-25X12 - Group marker label for terminal marking

0810588

<https://www.phoenixcontact.com/us/products/0810588>



Group marker label, snaps onto terminal center for screw, spring-cage and quick connection terminal blocks, labeled with a 25 x 12 mm label or manually with the B-STIFT, in the foot part with ZB 5

# RIF-1-RSC-LDP-24DC/2X21 - Relay Module



2903350

<https://www.phoenixcontact.com/us/products/2903350>

## GBS 5-25X5 - Group marker label for terminal marking

0829126

<https://www.phoenixcontact.com/us/products/0829126>



Group marking label, can be snapped into terminal center for screw, spring-cage, push-in, and fast connection terminal blocks, can be labeled with a 24 x 4 mm label or manually using B-STIFT, in the foot part with ZB 5

---

## STP 5-2-ZB - Marker carriers

3037643

<https://www.phoenixcontact.com/us/products/3037643>



Marker carriers, snaps into ST 2,5 spring-cage terminal blocks, can be marked with UC-TM 5, UC-TMF 5, UCT-TM 5, UCT-TMF 5, ZB 5, or ZBF 5, gray, unlabeled, mounting type: snapped



# RIF-1-RSC-LDP-24DC/2X21 - Relay Module



2903350

<https://www.phoenixcontact.com/us/products/2903350>

## ZB 15:UNBEDRUCKT - Zack marker strip

0811972

<https://www.phoenixcontact.com/us/products/0811972>

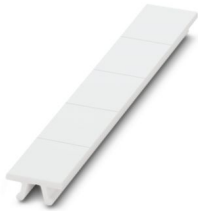

Zack marker strip, Strip, white, unlabeled, can be labeled with: PLOTMARK, CMS-P1-PLOTTER, mounting type: snapped, for terminal block width: 15.2 mm, lettering field size: 10.5 x 15.1 mm, Number of individual labels: 5

---

## ZB 15 CUS - Zack marker strip

0824945

<https://www.phoenixcontact.com/us/products/0824945>

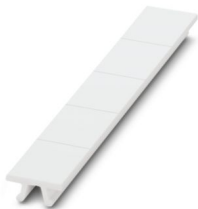

Zack marker strip, can be ordered: Strip, white, labeled according to customer specifications, mounting type: snap into tall marker groove, for terminal block width: 15.2 mm, lettering field size: 10.5 x 15.1 mm, Number of individual labels: 5

# RIF-1-RSC-LDP-24DC/2X21 - Relay Module



2903350

<https://www.phoenixcontact.com/us/products/2903350>

## ZB 15,LGS:L1-N,PE - Zack marker strip

0811998

<https://www.phoenixcontact.com/us/products/0811998>



Zack marker strip, Strip, white, labeled, printed horizontally: L1, L2, L3, N, PE, mounting type: snapped, for terminal block width: 15.2 mm, lettering field size: 10.5 x 15.1 mm, Number of individual labels: 5

---

## UC-TM 16 - Marker for terminal blocks

0819217

<https://www.phoenixcontact.com/us/products/0819217>



Marker for terminal blocks, Sheet, white, unlabeled, can be labeled with: BLUEMARK ID COLOR, BLUEMARK ID, BLUEMARK CLED, PLOTMARK, CMS-P1-PLOTTER, mounting type: snapped, for terminal block width: 16 mm, lettering field size: 15.45 x 10.5 mm, Number of individual labels: 32

# RIF-1-RSC-LDP-24DC/2X21 - Relay Module



2903350

<https://www.phoenixcontact.com/us/products/2903350>

## UC-TMF 16 - Marker for terminal blocks

0819262

<https://www.phoenixcontact.com/us/products/0819262>



Marker for terminal blocks, Sheet, white, unlabeled, can be labeled with: BLUEMARK ID COLOR, BLUEMARK ID, BLUEMARK CLED, PLOTMARK, CMS-P1-PLOTTER, mounting type: snapped, for terminal block width: 16 mm, lettering field size: 15.45 x 5.1 mm, Number of individual labels: 32

---

## RIF-1-BSC/2X21 - Relay base

2900930

<https://www.phoenixcontact.com/us/products/2900930>



RIF-1... relay base, for miniature power relay with 1 or 2 changeover contacts or identical solid-state relays, screw connection, plug-in option for input/interference suppression modules, for mounting on NS 35/7,5

# RIF-1-RSC-LDP-24DC/2X21 - Relay Module



2903350

<https://www.phoenixcontact.com/us/products/2903350>

## REL-MR- 24DC/21-21 - Single relay

2961192

<https://www.phoenixcontact.com/us/products/2961192>

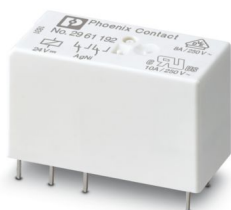

Plug-in miniature power relay, with power contact, 2 changeover contacts, input voltage 24 V DC

---

## RIF-LDP-12-24 DC - Plug-in module

2900939

<https://www.phoenixcontact.com/us/products/2900939>



Plug-in module, for mounting on RIF-1, RIF-2, RIF-3, and RIF-4, with freewheeling diode and yellow LED, polarity: A1+, A2-, input voltage: 12 V DC ... 24 V DC  $\pm 30\%$

# RIF-1-RSC-LDP-24DC/2X21 - Relay Module



2903350

<https://www.phoenixcontact.com/us/products/2903350>

## RIF-RH-1 - Retaining bracket

2900953

<https://www.phoenixcontact.com/us/products/2900953>



Relay retaining bracket, with ejector function and holder for marking material, suitable for RIF-1 relay base, for 16 mm tall miniature power relay and solid-state relay

---

Phoenix Contact 2024 © - all rights reserved

<https://www.phoenixcontact.com>

Phoenix Contact USA

586 Fulling Mill Road

Middletown, PA 17057, United States

(+717) 944-1300

[info@phoenixcon.com](mailto:info@phoenixcon.com)