

# Precision SMD TCXO/VCTCXO

AST3TQ53



ESD Sensitive



RoHS/RoHS II Compliant

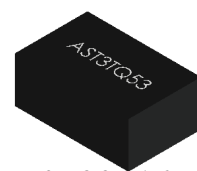

5.0 x 3.2 x 1.6mm

## Moisture Sensitivity Level (MSL) – 3

### FEATURES:

- Standard available frequencies: 10.00, 12.80, 16.384, 19.20, 19.44, 20.00, 24.576, 25.00, 26.00, 30.72, 40.00, 50.00 MHz
- LVC MOS Output or Clipped Sine Wave output
- Frequency stabilities to include  $\pm 50$ ppb,  $\pm 100$ ppb and  $\pm 280$ ppb over  $-40^{\circ}\text{C}$  to  $+85^{\circ}\text{C}$  operating temperature range
- Excellent Phase Noise, Harmonics and Spurious content
- Typical rms jitter of 400fs @ 40MHz carrier & 1.0ps @ 10MHz carrier over 12kHz to 20MHz BW

### APPLICATIONS:

- COTS Military Radios & other Communication Hardware
- WiMax,
- LTE, BTS
- CATV, LAN, LMDS
- GPS Tracking with Hold-Over accuracy
- Test & Measurement Equipment
- Point-to-Point communication networks

### STANDARD SPECIFICATIONS:

#### Maximum Rating

Parameters	Rating
Storage Temperature Range	-55 to +125°C
Supply Voltage	-0.5 to 6V
Control Voltage	0 to 3V
ESD, HBM/CDM/MM	4kV/2kV/200V

#### Key Electrical Specifications

Parameters	Minimum	Typical	Maximum	Units	Notes
Frequency Range	10		51.2	MHz	
Standard Frequencies	10.00, 12.80, 16.384, 19.20, 19.44, 20.00, 24.576, 25.00, 26.00, 30.72, 40.00, 50.00			MHz	
Initial Frequency Tolerance (@+25°C) at shipping			$\pm 0.5$	ppm	Relative to carrier
<b>Frequency Stability Options (Ref. to Frequency @+25°C)</b>					
-40°C to +85°C			$\pm 50$	ppb	Option "5"
-40°C to +85°C			$\pm 100$	ppb	Option "1"
-40°C to +85°C			$\pm 280$	ppb	Option "2"
Frequency Stability vs. Supply Voltage Change (Vdd $\pm 5\%$ )			$\pm 100$	ppb	
Frequency Stability vs. Load Change (Load $\pm 5\%$ )			$\pm 200$	ppb	
Aging (first year @+25°C)			$\pm 1.0$	ppm	
Aging (20 years @+25°C)		$\pm 3.0$	$\pm 4.6$	ppm	
Supply Voltage (Vdd)	+3.135	+3.3	+3.465	V	
Supply Current (Icc)			10.0	mA	No load
<b>Control Port ( Applicable for VCTCXO only)</b>					
Control Voltage Range (Vc)	+0.5	+1.5	+2.5	V	
Center Control Voltage (Vc)		+1.5		V	To be with-in $\pm 500$ ppb of Fc @ 25°C (at shipping)
Frequency Tuning Range	$\pm 5$	$\pm 7$	$< \pm 13$	ppm	
Tuning Slope	Positive				
Linearity			$\pm 10$	%	
Port Impedance	100			k $\Omega$	

REVISED: 2.16.2021



5101 Hidden Creek Ln Spicewood TX 78669  
 Phone: 512-371-6159 | Fax: 512-351-8858  
 For terms and conditions of sales, please visit: [www.abracon.com](http://www.abracon.com)

ABRACON IS  
 ISO9001-2015  
 CERTIFIED

# Precision SMD TCXO/VCTCXO

AST3TQ53



ESD Sensitive



RoHS/RoHS II Compliant



5.0 x 3.2 x 1.6mm

## STANDARD SPECIFICATIONS:

(Continued)

Parameters	Minimum	Typical	Maximum	Unites	Notes
Phase Noise (10MHz carrier frequency @25°C):			-95	dBc/Hz	Offset @10Hz
			-120		Offset @100Hz
			-140		Offset @1kHz
			-145		Offset @10kHz
			-150		Offset @100kHz
RMS Jitter (@12kHz~5MHz BW)	0.4		1.3	ps	Carrier Dependent
<b>Clipped Sine Wave</b>					
Output Level	0.8			Vp-p	
Output Load	10kΩ//10pF				
<b>LVC MOS Output (Square Wave)</b>					
V <sub>OH</sub>	2.4			V	Output Load=15pF
V <sub>OL</sub>			0.4	V	Output Load=15pF
Output Load			15	pF	
Duty Cycle	45		55	%	@(V <sub>OH</sub> - V <sub>OL</sub> )/2
Rise/Fall Time			6	ns	Output Load=15pF

## PART IDENTIFICATION:

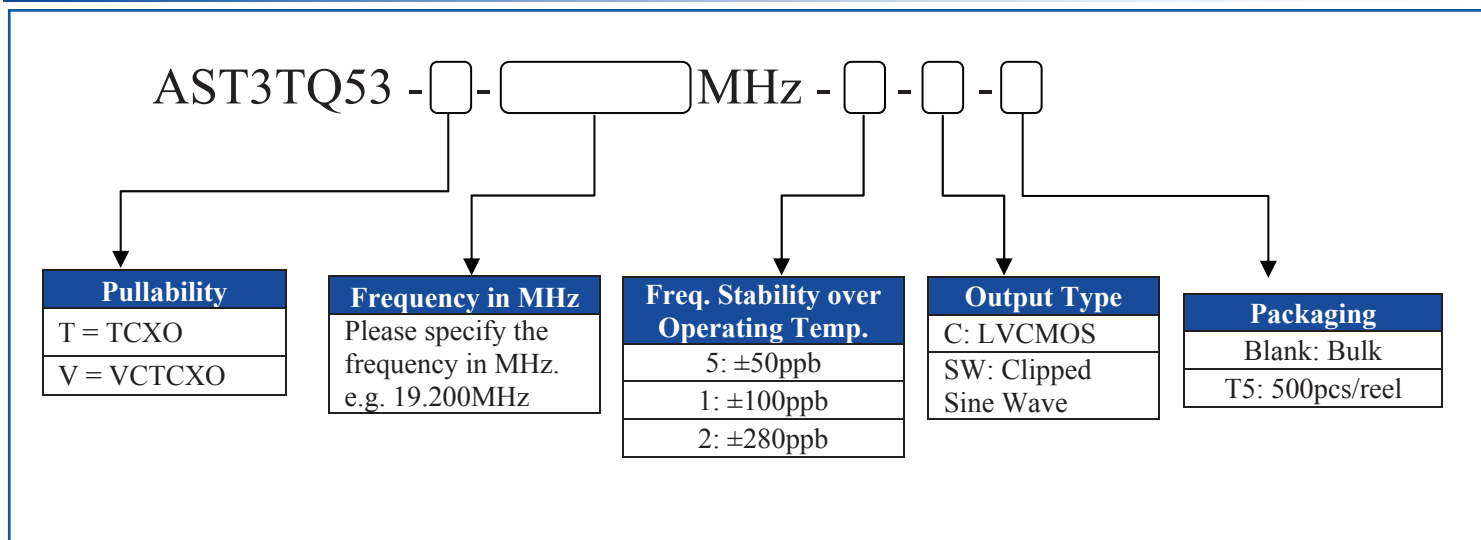

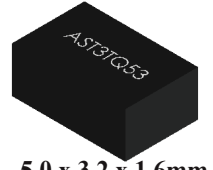

5.0 x 3.2 x 1.6mm

AST3TQ53



ESD Sensitive



RoHS/RoHS II Compliant

## TYPICAL FREQUENCY STABILITY VS. TEMPERATURE



## TYPICAL SHORT TERM STABILITY

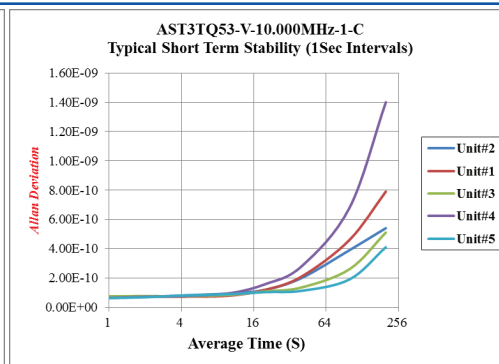
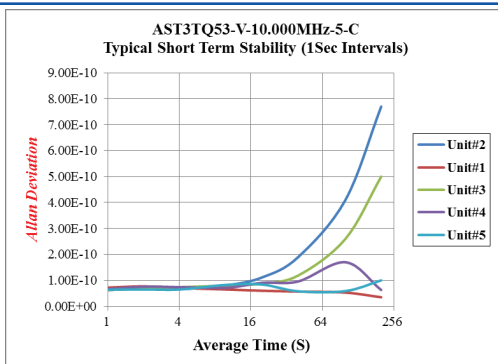

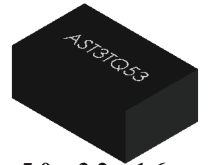

### TYPICAL AGING:

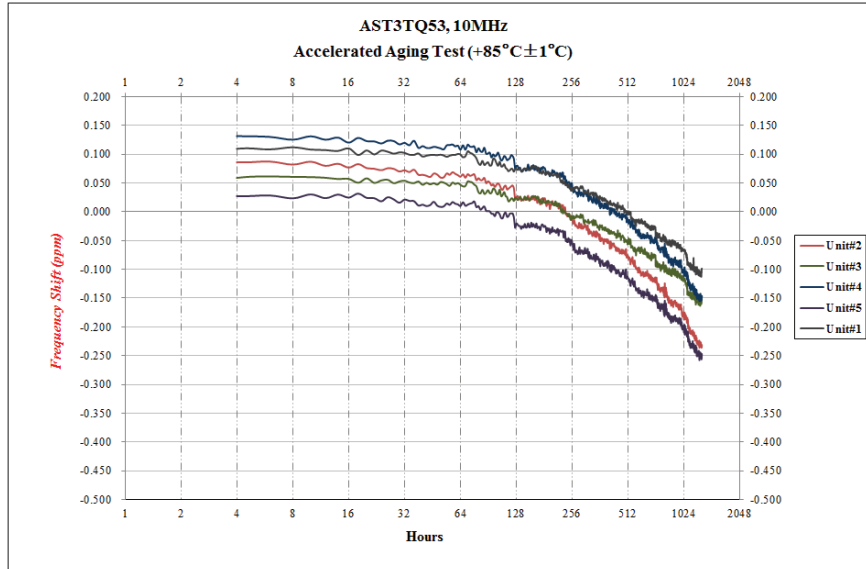

Aging Test Conditions	
Series	AST3TQ53
Frequency	10MHz
Acquisition Mode	Cycle
Acquisition Time	1129 hours
Test Temperature	+85°C ± 1°C
Number of Samples	5pcs

Aging Data			
No.	Aging Time (hrs)	Aging/Day (ppm)	Projected Aging/year (ppm)
#1	1129	-0.0039	-0.3896
#2	1129	-0.0059	-0.5925
#3	1129	-0.0042	-0.4202
#4	1129	-0.0056	-0.5555
#5	1129	-0.0055	-0.5492

# Precision SMD TCXO/VCTCXO

AST3TQ53



ESD Sensitive



RoHS/RoHS II Compliant

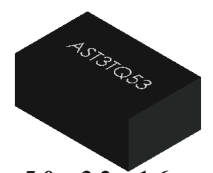

5.0 x 3.2 x 1.6mm

## MECHANICAL DIMENSIONS:

**Effective before 02/10/2021:**

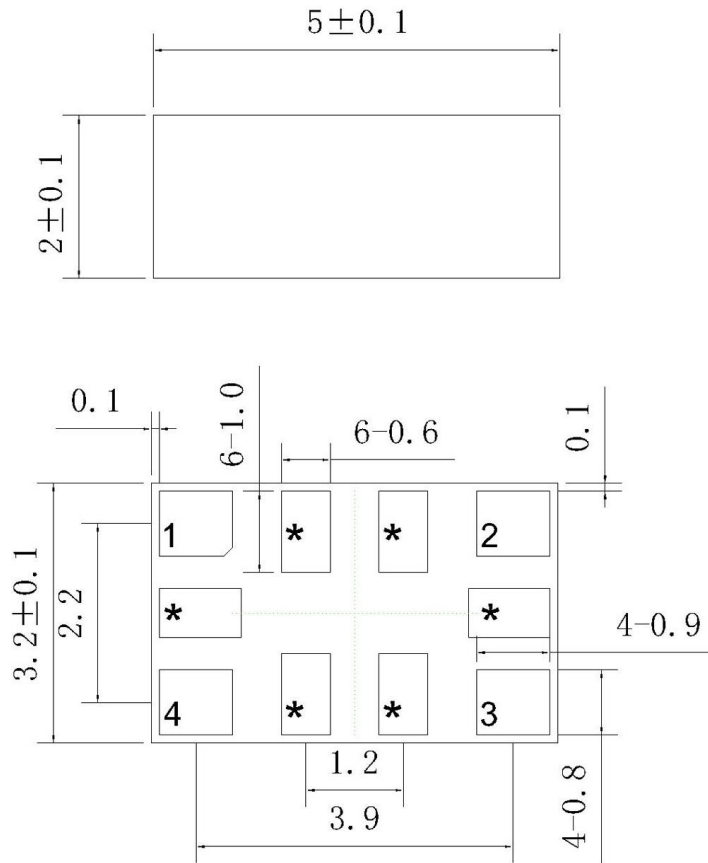

Pin	Function
1	NC (for TCXO) Vc (for VCTCXO)
2	GND
3	Output
4	Vdd
*	For factory test only

### Recommended Land Pattern

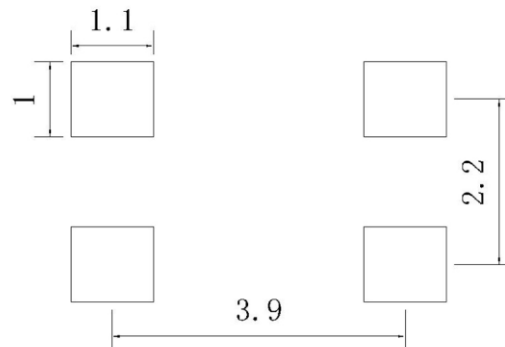

Dimensions: mm

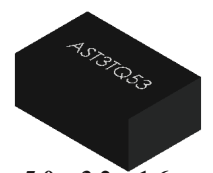

## MECHANICAL DIMENSIONS:

**Effective after 02/10/2021:**

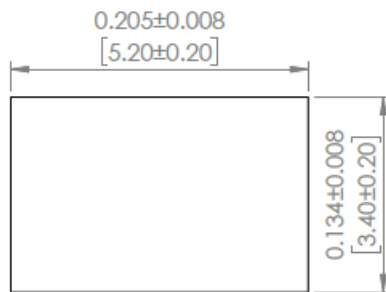

**TOP VIEW**

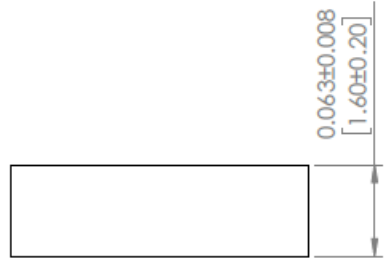

**FRONT VIEW**

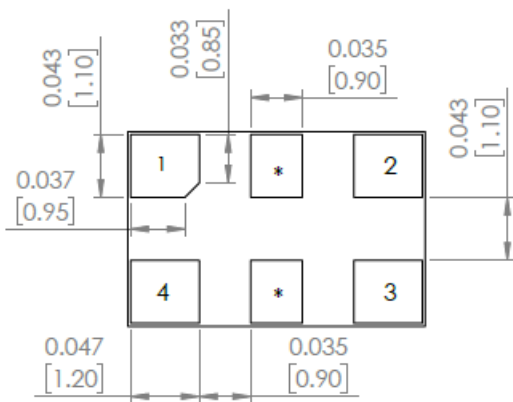

**BOTTOM VIEW**

### **Recommended Land Pattern**

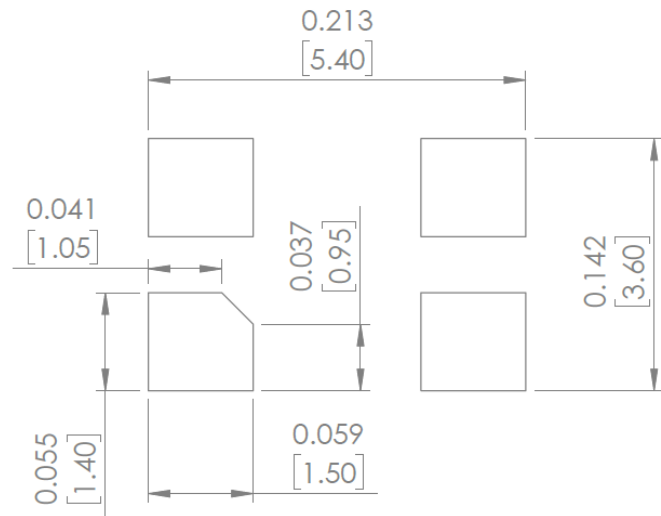

Pin	Function
1	NC (for TCXO) Vc (for VCTCXO)
2	GND
3	Output
4	Vdd
*	For factory test only

Dimensions: inches [mm]

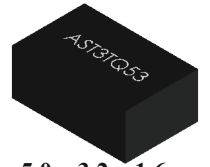

## REFLOW PROFILE [JEDEC J-STD-020]

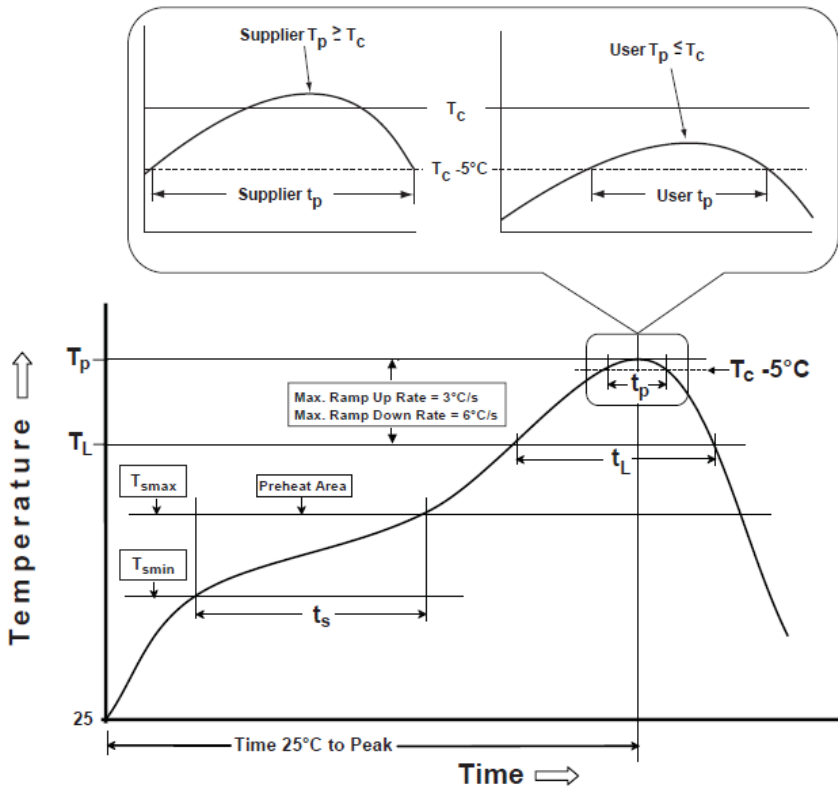

Table 1

SnPb Eutectic Process Classification Temperatures (T <sub>c</sub> )		
Package Thickness	Volume mm <sup>3</sup> <350	Volume mm <sup>3</sup> >350
<2.5 mm	235 °C	220 °C
>2.5 mm	220 °C	220 °C

Table 2

Pb-Free Process Classification Temperatures (T <sub>c</sub> )			
Package Thickness	Volume mm <sup>3</sup> <350	Volume mm <sup>3</sup> 350-2000	Volume mm <sup>3</sup> >2000
<1.6 mm	260 °C	260 °C	260 °C
1.6 mm - 2.5 mm	260 °C	250 °C	245 °C
>2.5 mm	250 °C	245 °C	245 °C

Profile Feature	Sn-Pb Eutectic Assembly	Pb-Free Assembly
Preheat / soak		
Temperature minimum (T <sub>smin</sub> )	100°C	150°C
Temperature maximum (T <sub>smax</sub> )	150°C	200°C
Time (T <sub>smin</sub> to T <sub>smax</sub> ) (t <sub>s</sub> )	60 - 120 sec.	60 - 120 sec.
Average ramp-up rate (T <sub>smax</sub> to T <sub>p</sub> )	3°C/sec. max	3°C/sec. max
Liquidous temperature (T <sub>L</sub> )	183°C	217°C
Time at liquidous (t <sub>L</sub> )	60 - 150 sec.	60 - 150 sec.
Peak package body temperature (T <sub>p</sub> )*	see Table 1	see Table 2
Time (t <sub>p</sub> )** within 5°C of the specified classification temperature (T <sub>c</sub> )	20 sec.	30 sec.
Ramp-down rate (T <sub>p</sub> to T <sub>smax</sub> )	6°C/sec. max	6°C/sec. max
Time 25°C to peak temperature	6 min. max	8 min. max
Reflow cycles	2 max	2 max

\*Tolerance for peak profile temperature (T<sub>p</sub>) is defined as a supplier minimum and a user maximum.

\*\*Tolerance for time at peak profile temperature (t<sub>p</sub>) is defined as supplier minimum and a user maximum.

# Precision SMD TCXO/VCTCXO

AST3TQ53



ESD Sensitive



RoHS/RoHS II Compliant

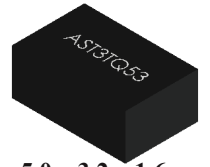

5.0 x 3.2 x 1.6mm

## PACKAGING:

**Packaging:**

**T5: 500pcs/reel**

**MSL-3 packaging applies to MOQ=25 units (cut tape) and "T5".**

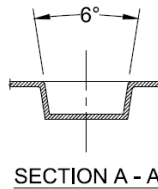
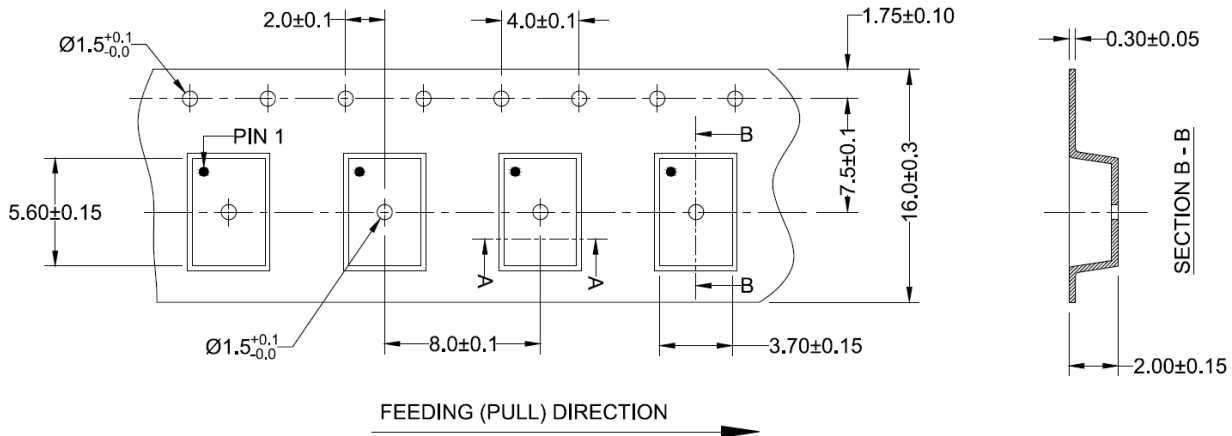

Unit: mm

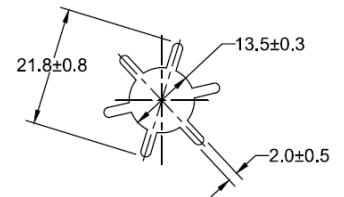
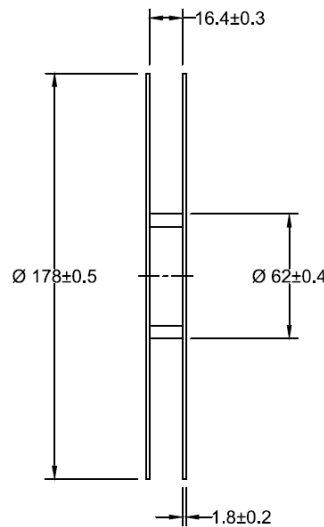
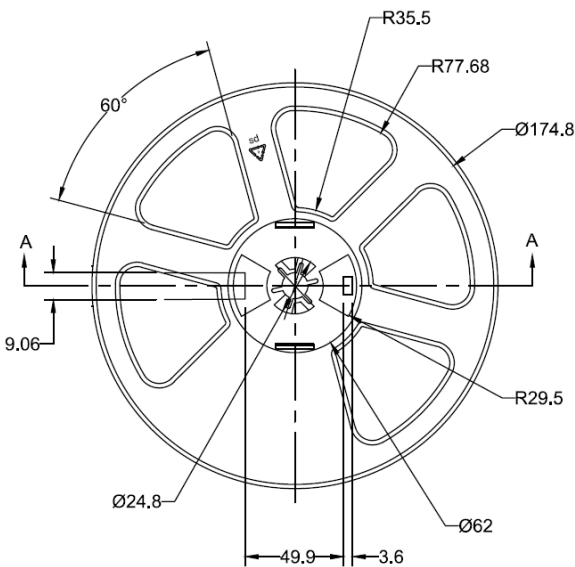

Dimensions: mm

**ATTENTION:** Abracon LLC's products are COTS – Commercial-Off-The-Shelf products; suitable for Commercial, Industrial and, where designated, Automotive Applications. Abracon's products are not specifically designed for Military, Aviation, Aerospace, Life-dependent Medical applications or any application requiring high reliability where component failure could result in loss of life and/or property. For applications requiring high reliability and/or presenting an extreme operating environment, written consent and authorization from Abracon LLC is required. Please contact Abracon LLC for more information.



5101 Hidden Creek Ln Spicewood TX 78669  
 Phone: 512-371-6159 | Fax: 512-351-8858  
 For terms and conditions of sales, please visit: [www.abracon.com](http://www.abracon.com)

REVISED: 2.16.2021

ABRACON IS  
 ISO9001-2015  
 CERTIFIED



# Mouser Electronics

Authorized Distributor

Click to View Pricing, Inventory, Delivery & Lifecycle Information:

## ABRACON:

[AST3TQ53-T-10.000MHz-1-C](#) [AST3TQ53-V-40.000MHz-2-SW](#) [AST3TQ53-T-20.000MHz-5-C-T2](#) [AST3TQ53-V-26.000MHz-2-C-T2](#) [AST3TQ53-T-19.200MHz-1-SW](#) [AST3TQ53-T-20.000MHz-2-SW](#) [AST3TQ53-T-19.200MHz-1-C-T5](#) [AST3TQ53-V-16.384MHz-5-SW-T2](#) [AST3TQ53-V-10.000MHz-1-C-T2](#) [AST3TQ53-T-40.000MHz-5-C](#) [AST3TQ53-T-19.200MHz-1-C-T2](#) [AST3TQ53-T-25.000MHz-2-C-T5](#) [AST3TQ53-V-19.440MHz-2-SW-T2](#) [AST3TQ53-V-25.000MHz-2-C-T2](#) [AST3TQ53-V-12.800MHz-2-C-T2](#) [AST3TQ53-V-19.440MHz-1-SW-T5](#) [AST3TQ53-T-10.000MHz-2-SW-T2](#) [AST3TQ53-T-30.720MHz-2-SW](#) [AST3TQ53-V-20.000MHz-1-SW](#) [AST3TQ53-V-25.000MHz-1-C-T5](#) [AST3TQ53-T-24.576MHz-1-SW-T5](#) [AST3TQ53-T-40.000MHz-1-SW](#) [AST3TQ53-T-10.000MHz-2-C-T5](#) [AST3TQ53-T-19.440MHz-1-C](#) [AST3TQ53-V-10.000MHz-2-C-T2](#) [AST3TQ53-V-12.800MHz-5-SW](#) [AST3TQ53-V-10.000MHz-2-C-T5](#) [AST3TQ53-V-30.720MHz-1-SW](#) [AST3TQ53-T-40.000MHz-5-SW-T5](#) [AST3TQ53-T-16.384MHz-1-SW-T5](#) [AST3TQ53-V-16.384MHz-5-SW](#) [AST3TQ53-V-26.000MHz-1-C-T2](#) [AST3TQ53-V-26.000MHz-5-SW-T2](#) [AST3TQ53-T-26.000MHz-2-SW](#) [AST3TQ53-T-30.720MHz-1-SW](#) [AST3TQ53-T-19.440MHz-2-C-T2](#) [AST3TQ53-T-19.440MHz-5-SW](#) [AST3TQ53-T-26.000MHz-1-C-T5](#) [AST3TQ53-V-26.000MHz-2-SW](#) [AST3TQ53-T-40.000MHz-2-C](#) [AST3TQ53-T-40.000MHz-2-SW](#) [AST3TQ53-V-30.720MHz-2-C-T2](#) [AST3TQ53-T-16.384MHz-1-SW-T2](#) [AST3TQ53-V-40.000MHz-2-SW-T5](#) [AST3TQ53-T-26.000MHz-2-SW-T2](#) [AST3TQ53-T-20.000MHz-5-SW-T2](#) [AST3TQ53-T-30.720MHz-1-C-T5](#) [AST3TQ53-T-30.720MHz-5-C-T5](#) [AST3TQ53-T-30.720MHz-5-SW](#) [AST3TQ53-V-25.000MHz-1-SW-T2](#) [AST3TQ53-V-19.440MHz-2-C-T5](#) [AST3TQ53-V-12.800MHz-1-C-T5](#) [AST3TQ53-V-16.384MHz-2-SW-T5](#) [AST3TQ53-V-19.200MHz-5-C-T5](#) [AST3TQ53-V-26.000MHz-1-C](#) [AST3TQ53-V-40.000MHz-1-SW-T5](#) [AST3TQ53-V-26.000MHz-5-SW](#) [AST3TQ53-V-16.384MHz-5-C](#) [AST3TQ53-T-16.384MHz-2-C-T2](#) [AST3TQ53-T-19.200MHz-2-SW](#) [AST3TQ53-T-30.720MHz-5-SW-T5](#) [AST3TQ53-T-16.384MHz-5-SW](#) [AST3TQ53-T-24.576MHz-1-SW](#) [AST3TQ53-T-12.800MHz-1-C](#) [AST3TQ53-T-16.384MHz-1-C](#) [AST3TQ53-V-30.720MHz-1-C-T5](#) [AST3TQ53-T-20.000MHz-5-SW-T5](#) [AST3TQ53-V-20.000MHz-2-SW-T2](#) [AST3TQ53-V-10.000MHz-2-SW-T2](#) [AST3TQ53-V-20.000MHz-5-SW-T5](#) [AST3TQ53-V-19.200MHz-2-C-T2](#) [AST3TQ53-V-26.000MHz-5-C-T2](#) [AST3TQ53-T-26.000MHz-1-SW](#) [AST3TQ53-T-40.000MHz-5-SW](#) [AST3TQ53-T-16.384MHz-2-C-T5](#) [AST3TQ53-V-26.000MHz-5-C-T5](#) [AST3TQ53-T-19.200MHz-2-SW-T5](#) [AST3TQ53-T-30.720MHz-1-C-T2](#) [AST3TQ53-V-26.000MHz-5-C](#) [AST3TQ53-V-19.200MHz-1-SW](#) [AST3TQ53-V-24.576MHz-5-C-T5](#) [AST3TQ53-V-20.000MHz-5-C](#) [AST3TQ53-T-10.000MHz-5-SW](#) [AST3TQ53-V-10.000MHz-2-C](#) [AST3TQ53-V-25.000MHz-1-SW-T5](#) [AST3TQ53-T-20.000MHz-2-SW-T2](#) [AST3TQ53-T-25.000MHz-1-C](#) [AST3TQ53-T-26.000MHz-5-C-T5](#) [AST3TQ53-T-19.200MHz-5-SW-T2](#) [AST3TQ53-T-12.800MHz-2-SW-T5](#) [AST3TQ53-T-16.384MHz-2-SW-T5](#) [AST3TQ53-V-40.000MHz-1-C-T5](#) [AST3TQ53-T-24.576MHz-5-C](#) [AST3TQ53-T-12.800MHz-5-C-T2](#) [AST3TQ53-V-19.200MHz-2-SW-T5](#) [AST3TQ53-T-12.800MHz-5-C](#) [AST3TQ53-T-40.000MHz-1-C-T2](#) [AST3TQ53-T-20.000MHz-5-SW](#) [AST3TQ53-T-](#)

19.440MHz-2-C-T5 AST3TQ53-V-19.200MHz-2-C-T5