

DCS-2



2.8 mm female and male terminals

Features

- DCS-2 technology
- Long auxiliary steel spring in CrNi
- 5 mm pitch for unsealed applications
- 6 mm pitch for sealed applications with single wire seal
- Single wire seal versions available
- Crimp code on terminal
- Suitable for secondary lock
- Selective gold-plated versions available

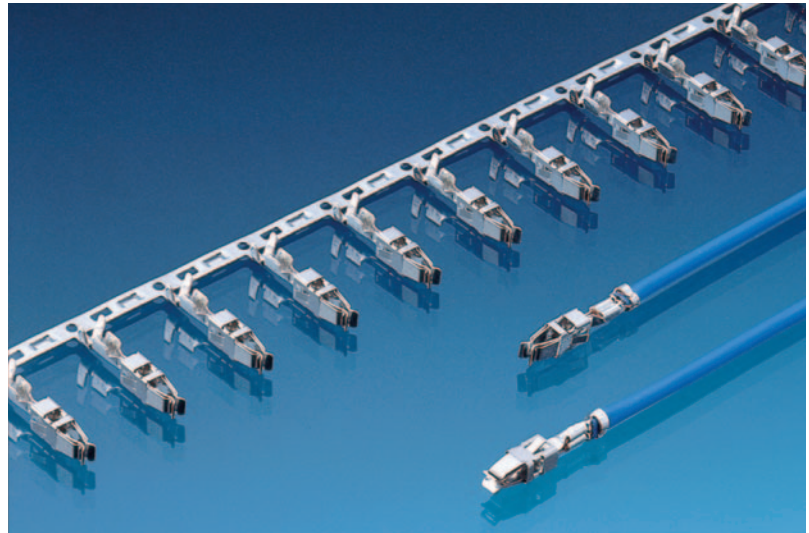

Performance characteristics*

- Contact resistance: < 2 mΩ
- Contact mating force: < 9 N
- Contact unmating force: < 5 N
- Current carrying capacity with 2.5 mm² wire:

at 23°C up to approx.:	33 A
at 85°C up to approx.:	22 A
at 100°C up to approx.:	17 A

* Mated with 2.8 x 0.8 mm DCS-2 male terminal (Sn)

Packing

- No. of terminals per reel: Consult us
- No. of reels per packing: Consult us

Tooling

- Manual crimping tool: Consult us
- Mini applicator: Consult us

Part Numbers	Type	Wire size range (in mm ²)		Insulation Ø (in mm) Max.	Material	Plating
		Min.	Max.			
6 001 28 11	Female	0.20	0.35	1.30	CuSn/CrNi	Sn
6 001 28 31	Female	0.50	1.00	2.00	CuSn/CrNi	Sn
6 001 28 41	Female	> 1.00	2.50	3.00	CuSn/CrNi	Sn
6 001 29 11 (SWS)	Female	0.20	0.35	1.30	CuSn/CrNi	Sn
6 001 29 31 (SWS)	Female	0.50	1.00	2.00	CuSn/CrNi	Sn
6 001 29 41 (SWS)	Female	> 1.00	2.50	3.00	CuSn/CrNi	Sn
6 001 40 11	Female	0.20	0.35	1.30	CuFe/CrNi	Sn
6 001 40 31	Female	0.50	1.00	2.00	CuFe/CrNi	Sn
6 001 40 41	Female	> 1.00	2.50	3.00	CuFe/CrNi	Sn
6 011 06 11	Male	0.20	0.35	1.30	CuFe/CrNi	Sn
6 011 06 31	Male	0.50	1.00	2.00	CuFe/CrNi	Sn
6 011 06 41	Male	> 1.00	2.50	3.00	CuFe/CrNi	Sn

SWS: Single Wire Seal

DCS-2



2.8 mm female and male terminals

Part Numbers	Type	Wire size range (in mm ²)		Insulation Ø (in mm)	Material	Plating
		Min.	Max.	Max.		
6 011 06 14	Male	0.20	0.35	1.30	CuSn/CrNi	Au
6 011 06 34	Male	0.50	1.00	2.00	CuSn/CrNi	Au
6 011 06 44	Male	> 1.00	2.50	3.00	CuSn/CrNi	Au
6 011 07 11 (SWS)	Male	0.20	0.35	1.30	CuFe/CrNi	Sn
6 011 07 31 (SWS)	Male	0.50	1.00	2.00	CuFe/CrNi	Sn
6 011 07 41 (SWS)	Male	> 1.00	2.50	3.00	CuFe/CrNi	Sn
6 011 07 14 (SWS)	Male	0.20	0.35	1.30	CuSn/CrNi	Au
6 011 07 34 (SWS)	Male	0.50	1.00	2.00	CuSn/CrNi	Au
6 011 07 44 (SWS)	Male	> 1.00	2.50	3.00	CuSn/CrNi	Au

SWS: Single Wire Seal

Dimensional characteristics

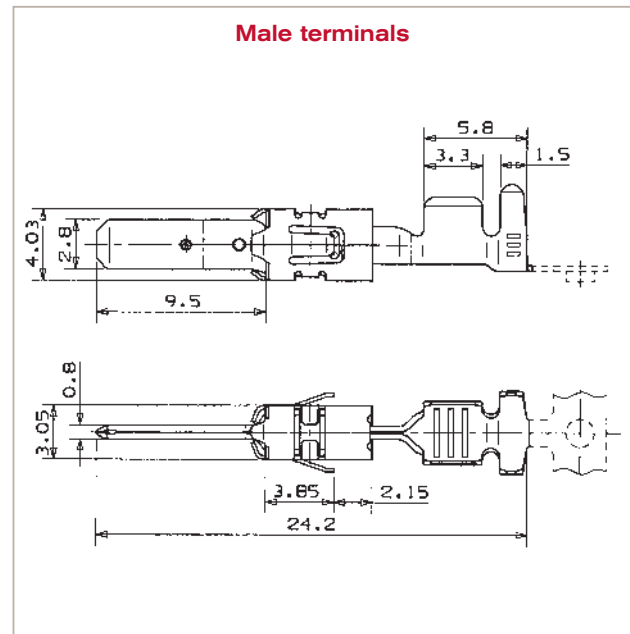
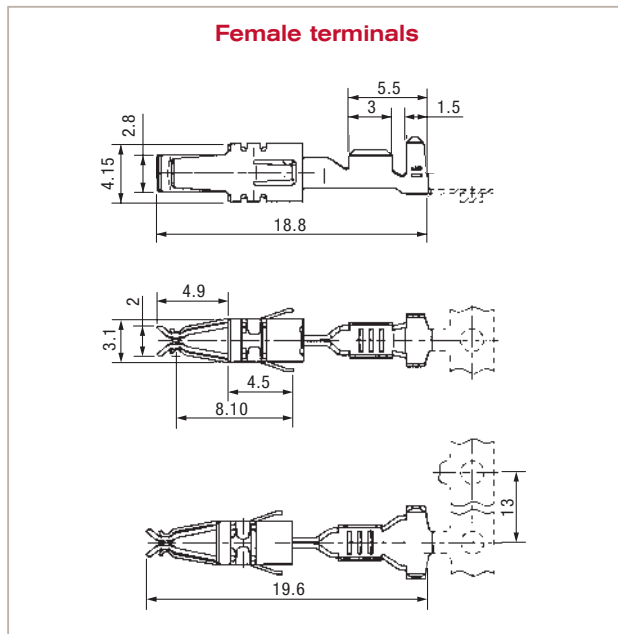

Mouser Electronics

Authorized Distributor

Click to View Pricing, Inventory, Delivery & Lifecycle Information:

[Aptiv:](#)

[60011741](#) [60011731](#)