

**TURCK**  
*works*

Industrial  
Automation

**Universal  
Magnetic Field  
Sensors**

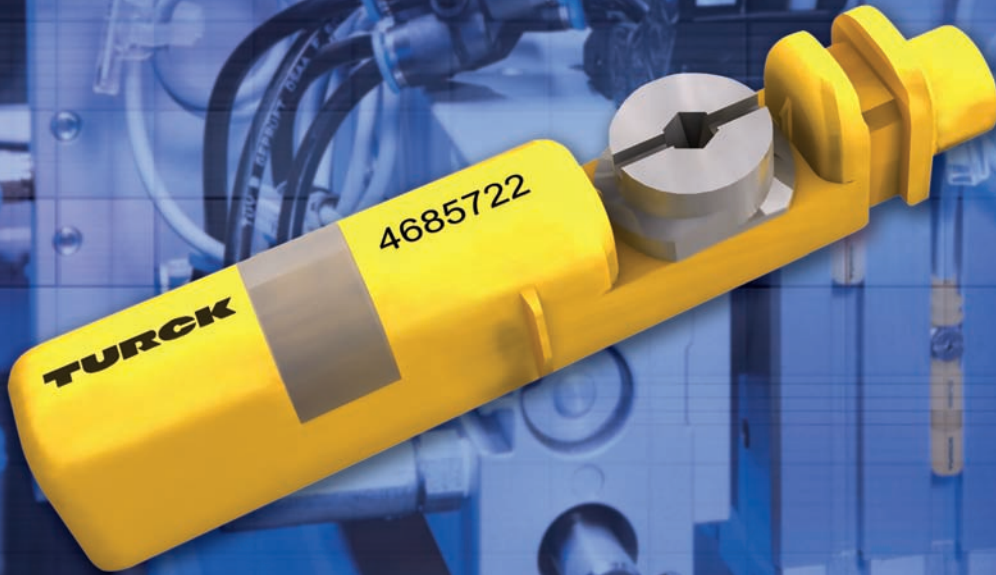

[www.turck.com](http://www.turck.com)

The **BIM-UNT**, a universal magnetic field sensor, is the latest addition to the inductive-magnetic family of switches by **TURCK**. It has the ability to detect the position of a piston on all types of standard pneumatic cylinders. The sensor is polarity protected, has reliable switching points and a fast response time. It is immune to high levels of EMC and vibration, and is IP 67 rated for use in harsh environments.

The **BIM-UNT** not only offers improved packaging and performance, it also simplifies maintenance, helps prevent over-stocking and streamlines the production process. Additionally, it comes with compatible accessories to help ease installation.

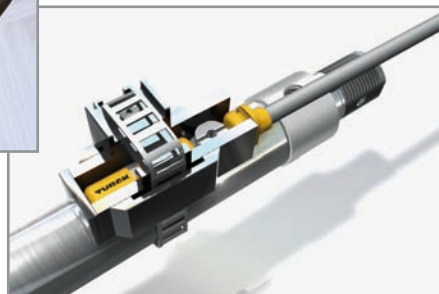
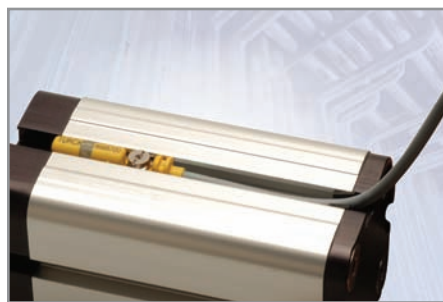
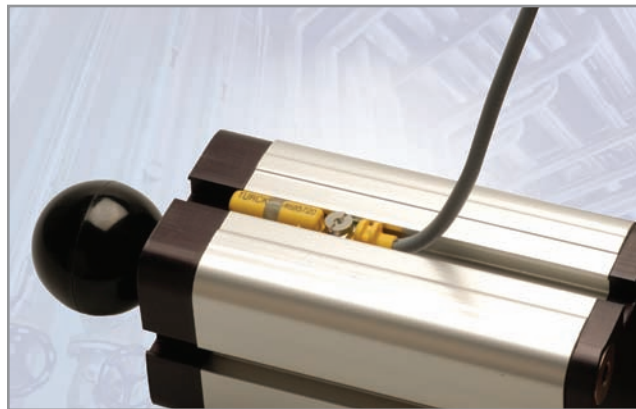
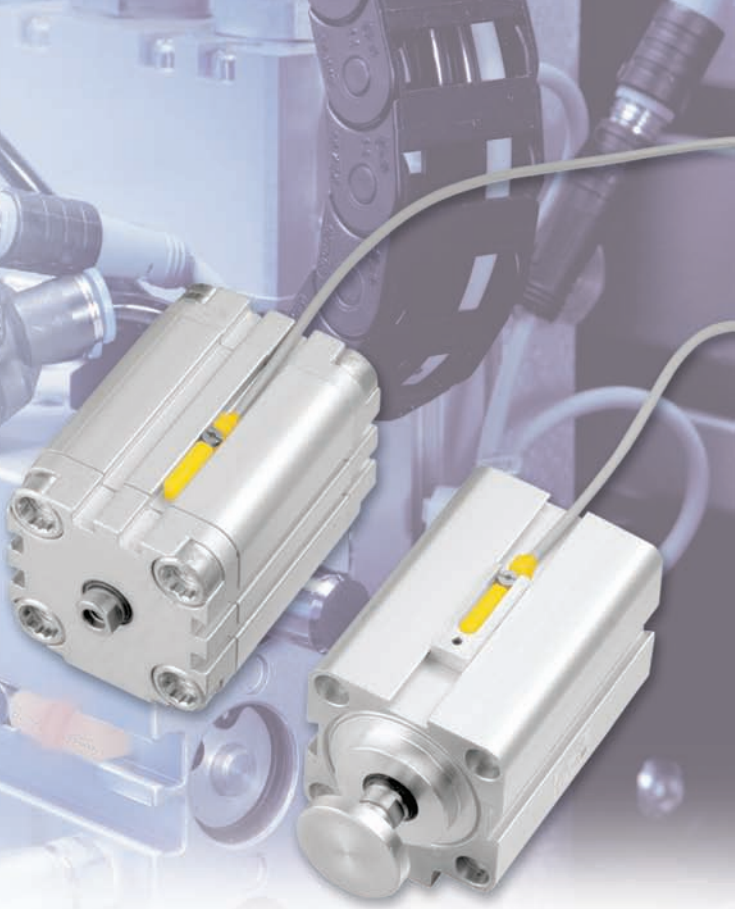

### Mounting Advantages

The **BIM-UNT** universal magnetic field sensor is designed to detect the piston on all standard pneumatic cylinders. The sensor can be direct mounted with the help of cost-efficient accessories, making it one of the most versatile sensors on the market.

- A strategically placed wire and screw holds the sensor down – even when the cable is tugged on – and helps eliminate cable strain.
- The sensor is equipped with a simple and robust mounting system to ensure stability during operation. This makes it easy to install and ensures fewer re-adjustments of the sensor.
- Economical accessories, from precision mounts and wire-strain accessories, to optional clips that hold the wire in place in any shaped groove. This eliminates the need for expensive custom-fit accessories.

Types and Technical Data

Housing Styles	Part Number	ID Number	Connection
<p><b>BIM-UNT Potted-In Cable</b></p>	BIM-UNT-AP6X	S4685720	PUR cable, 2 m, PNP
	BIM-UNT-AN6X	S4685702	PUR cable, 2 m, NPN
	BIM-UNT-AP6X 7M	S4685721	PUR cable, 7 m, PNP
	BIM-UNT-AN6X 7M	S4685701	PUR cable, 7 m, NPN
<p><b>BIM-UNT <i>picofast</i>® Snap Lock Quick Disconnect</b></p>	BIM-UNT-AP6X-0.3M-PSG 3S	S4685722	Pigtail M8x1, snap lock / fixed thread, 0.3 m PUR cable, PNP
	BIM-UNT-AN6X-0.3M-PSG 3S	S4685705	Pigtail M8x1, snap lock / fixed thread, 0.3 m PUR cable, NPN
<p><b>BIM-UNT <i>picofast</i>® Quick Disconnect</b></p>	BIM-UNT-AP6X-0.3M-PSG 3M	S4685723	Pigtail M8x1, threaded coupling nut, 0.3 m PUR cable, PNP
	BIM-UNT-AN6X-0.3M-PSG 3M	S4685706	Pigtail M8x1, threaded coupling nut, 0.3 m PUR cable, NPN
	BIM-UNT-AP6X-0.6M-PSG 3M	S4685724	Pigtail M8x1, threaded coupling nut, 0.6 m PUR cable, PNP
<p><b>BIM-UNT <i>euromast</i>® Quick Disconnect</b></p>	BIM-UNT-AP6X-0.3M-RS 4T	S46857260	Pigtail M12x1, threaded coupling nut, 0.3 m PUR cable, PNP

**Mounting and Adjustment Accessories**

Dimensional Drawings	Part Number	ID Number	Description
	KLR-UNT1	M6970623	Accessory for mounting on a round/tie-rod cylinder, diameter = 8-25 mm.
	KLR-UNT2	M6970624	Accessory for mounting on a round/tie-rod cylinder, diameter = 25-63 mm.
	KLDT-UNT2	S6913351	Accessory for mounting on a dovetail cylinder, L = 7 mm.
	KLDT-UNT3	S6913352	Accessory for mounting on a dovetail cylinder, L = 9.4 mm.
	KLDT-UNT4	S6913353	Accessory for mounting on a dovetail cylinder, L = 11.5 mm.
	KLDT-UNT5	S6913354	Accessory for mounting on a dovetail cylinder, L = 12.6 mm.
	KLZ1-INT	M6970410	Accessory for mounting on a tie-rod cylinder, diameter = 32-40 mm.
	KLZ2-INT	M6970411	Accessory for mounting on a tie-rod cylinder, diameter = 50-63 mm.
	KLZ3-INT	M6970412	Accessory for mounting on a tie-rod cylinder, diameter = 80-100 mm.
	UNT-Adjusting Bracket	S4685750	Adjustable precision-tuning accessory for locating the switching points. Can be used multiple times.
	UNT-Stopper	S4685751	Accessory for marking the switching points on T-groove cylinders.
	INT Cable Clip	M6900456	Accessory for securing the cable in place to avoid cable strain. Packing unit = 10 pieces.  (One piece included in the BIM-UNT.)

## Stable and Reliable Mounting

After the sensor has been inserted into the cylinder's groove, a *quick-mount* tab on the side of the sensor helps seat the sensor until the screw is tightened. This makes it easy to mount the sensor with one hand, even while it is facing downwards. The screw is made of a tool steel alloy and can be tightened with the help of a 1.5 mm Allen wrench or a standard flat-head screwdriver. This ensures stability and resistance to vibration under the harshest conditions.

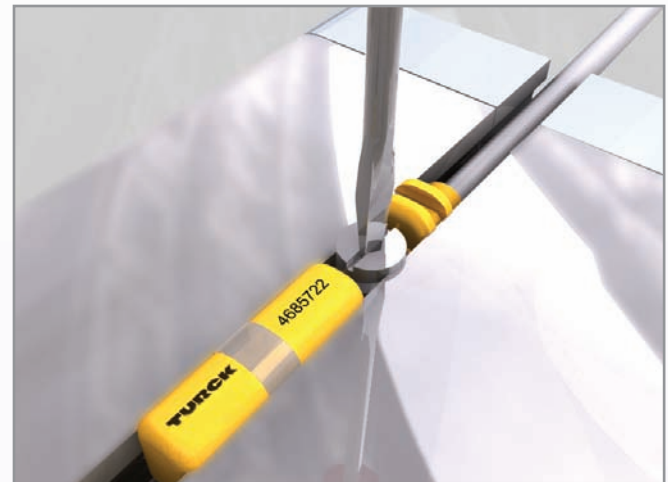

## Compact Housing Style & LED

The **BIM-UNT** comes with enhanced packaging and performance. It is only 28 mm in length, making it one of the most compact sensors on the market. The bright LED located on top of the sensor makes it possible to check the switching status from any convenient working angle. The sensing face is located near the front of the sensor, allowing the position of the piston rod to be consistently detected — even on compact, short stroke cylinders.

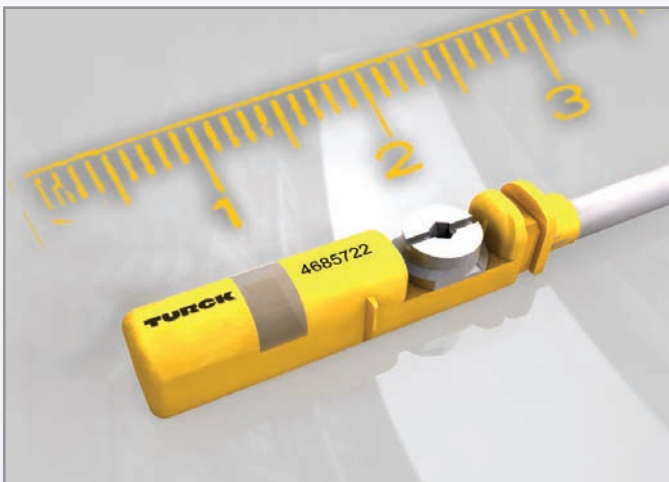

## Standards

Magneto Resistive technology enables the sensor to detect the exact position of the magnet, while avoiding multiple switching points. It also exceeds the IEC standard specifications, EN60947-5-2 and EN 61000-4-6, making it compliant with these standards and immune to high levels of EMC.

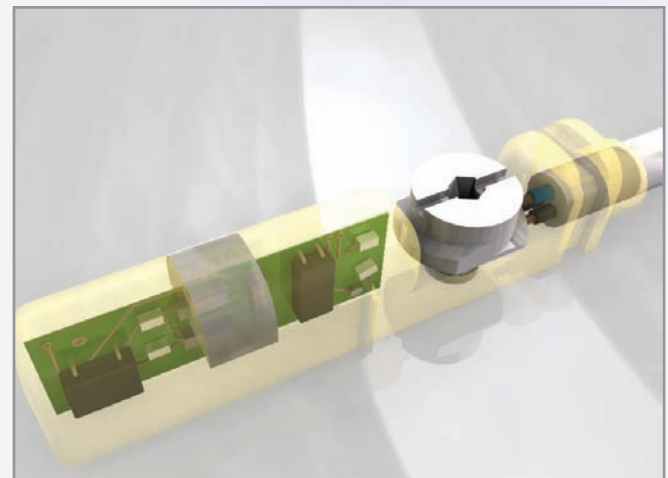

Ambient Temperature . . . . .	-25 to +70 °C (-13 to 158 °F)
Operating Voltage . . . . .	10 to 30 VDC
Ripple Vpp . . . . .	∞10% U <sub>ss</sub>
Rated Operating Current DC . . . . .	∞150 mA
No-load Current I <sub>o</sub> . . . . .	∞15 mA
Off-state Current . . . . .	∞0.1 mA
Switching Frequency . . . . .	∞1 kHz
Output Function . . . . .	3-wire, N.O., PNP
Short-circuit Protection . . . . .	Yes / Cyclic
Voltage Drop I <sub>e</sub> . . . . .	∞1.8 V
Wire-break/Reverse Polarity Protection ..	Yes / Completely
Vibration Resistance . . . . .	55 Hz (1mm)
Shock Resistance . . . . .	30 g (11 ms)
Degree of Protection . . . . .	IP67
Overtravel Speed . . . . .	10 m/s

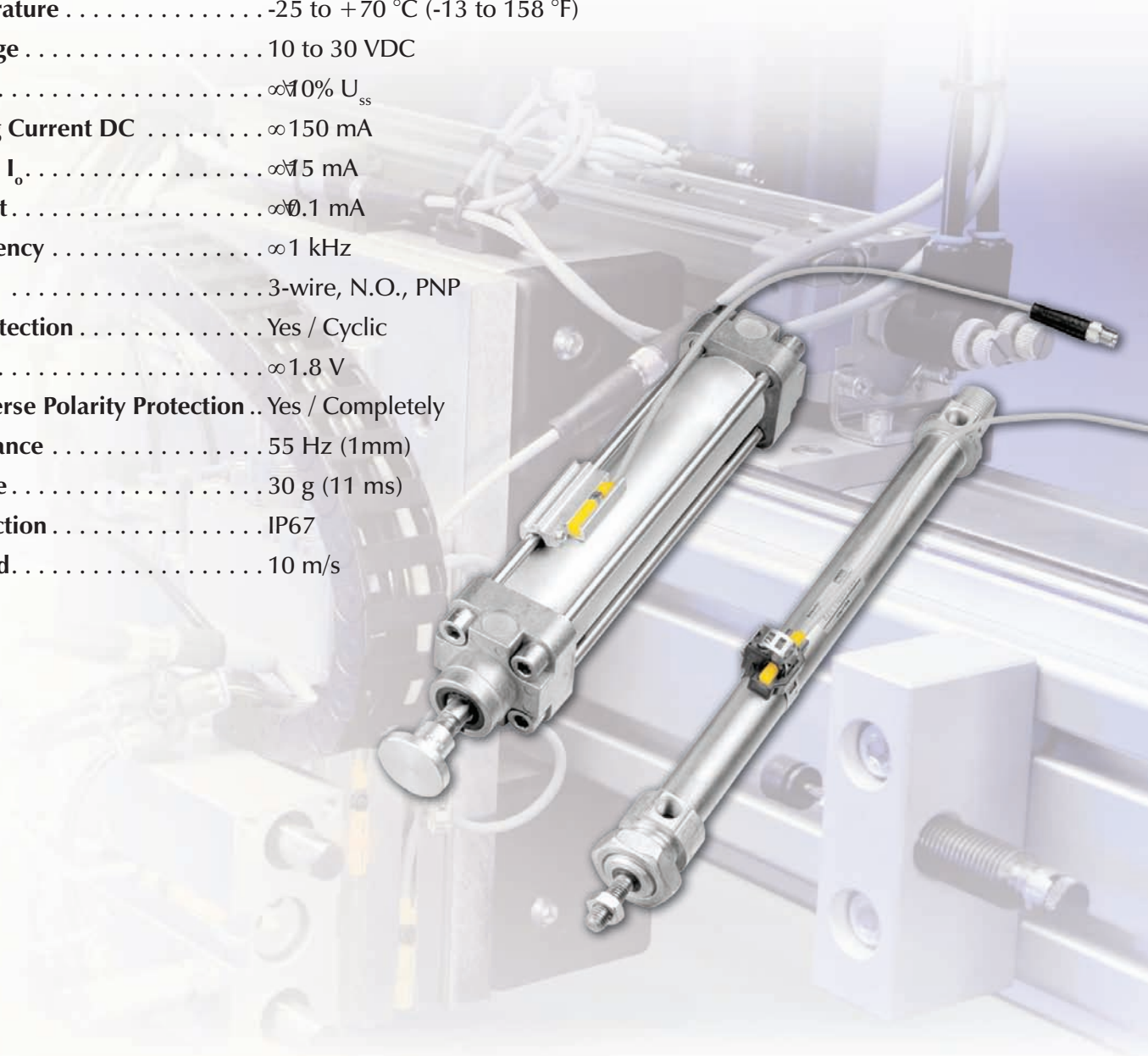

**TURCK USA**

TURCK Inc.  
3000 Campus Drive  
Minneapolis, MN 55441  
Phone: (763) 553-7300  
Fax: (763) 553-0708  
Application Support:  
1-800-544-7769

**TURCK Mexico**

TURCK MEXICO S. DE R.L. DE C.V.  
Carr Saltillo-Zacatecas km 4.5 s/n  
Parque Industrial "La Angostura"  
Saltillo, COAH. C.P. 25070  
MEXICO  
Phone: +52 (844) 411-6647/46  
Fax: +52 (844) 482-6926  
Toll Free: 01-800-01-88725 (Mexico only)  
email: ventasmexico@turck.com

**TURCK Canada**

CHARTWELL  
ELECTRONICS, INC.  
140 Duffield Drive  
Markham, Ontario  
Canada, L6G 1B5  
Phone: (905) 513-7100  
Fax: (905) 513-7101  
Toll Free: 1-877-513-7769

**TURCK**

**World Headquarters**

Hans TURCK GmbH & Co. KG  
Witzlebenstrasse 7  
D-45472 Muelheim der Ruhr  
Federal Republic Of Germany  
Phone: (+49) 208-49 52-0  
Fax: (+49) 208-49 52 264

**....Sense It!....Connect It!....Bus It!....Solve It!**