



MCR8DCM, MCR8DCN



Description

Designed for high volume, low cost, industrial and consumer applications such as motor control; process control; temperature, light and speed control.

Features

- Small Size
 - Passivated Die for Reliability and Uniformity
 - Low Level Triggering and Holding Characteristics
 - Available in Two Package Styles Surface Mount Lead Form – Case 369C
 - Epoxy Meets UL 94 V-0 @ 0.125 in
 - ESD Ratings: Human
- Body Model, 3B > 8000 V
Machine Model, C > 400 V
- Pb-Free Packages are Available

Pin Out

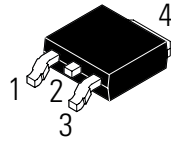

Functional Diagram

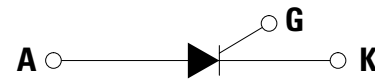

Additional Information



[Datasheet](#)



[Resources](#)



[Samples](#)

Maximum Ratings ($T_J = 25^\circ\text{C}$ unless otherwise noted)

Rating	Symbol	Value	Unit
Peak Repetitive Off-State Voltage (Note 1) (– 40 to 1125°C, Sine Wave, 50 to 60 Hz, Gate Open)	V_{DRM}^* V_{RRM}	600 800	V
On-State RMS Current (180° Conduction Angles; $T_C = 105^\circ\text{C}$)	$I_{T(RMS)}$	8.0	A
Average On-State Current (180° Conduction Angles; $T_C = 105^\circ\text{C}$)	$I_{T(AV)}$	5.1	A
Peak Non-Repetitive Surge Current (1/2 Cycle, Sine Wave 60 Hz, $T_J = 110^\circ\text{C}$)	I_{TSM}	80	A
Circuit Fusing Consideration ($t = 8.3$ ms)	I^2t	26	A ² sec
Forward Peak Gate Power (Pulse Width ≤ 10 μsec , $T_C = 105^\circ\text{C}$)	P_{GM}	5.0	W
Forward Average Gate Power ($t = 8.3$ msec, $T_C = 105^\circ\text{C}$)	$P_{GM(AV)}$	0.5	W
Forward Peak Gate Current (Pulse Width ≤ 1.0 μsec , $T_C = 105^\circ\text{C}$)	I_{GM}	2.0	A
Operating Junction Temperature Range	T_J	–40 to 125	°C
Storage Temperature Range	T_{stg}	–40 to 150	°C

Stresses exceeding Maximum Ratings may damage the device. Maximum Ratings are stress ratings only. Functional operation above the Recommended Operating Conditions is not implied. Extended exposure to stresses above the Recommended Operating Conditions may affect device reliability.

- V_{DRM}^* and V_{RRM} for all types can be applied on a continuous basis. Ratings apply for zero or negative gate voltage; however, positive gate voltage shall not be applied concurrent with negative potential on the anode. Blocking voltages shall not be tested with a constant current source such that the voltage ratings of the devices are exceeded.

Thermal Characteristics

Rating	Symbol	Value	Unit
Thermal Resistance, Junction-to-Case	$R_{\theta JC}$	2.2	°C/W
Thermal Resistance, Junction-to-Ambient	$R_{\theta JA}$	88	
Thermal Resistance, Junction-to-Ambient (Note 2)	$R_{\theta JA}$	80	
Maximum Device Temperature for Soldering Purposes (Note 3)	T_L	260	°C

Electrical Characteristics - OFF ($T_J = 25^\circ\text{C}$ unless otherwise noted)

Characteristic	Symbol	Min	Typ	Max	Unit	
Peak Repetitive Forward or Reverse Blocking Current (Note 3) ($V_{AK} = \text{Rated } V_{DRM} \text{ or } V_{RRM}, R_{GK} = 1.0$ k Ω)	I_{DRM}^* I_{RRM}	$T_J = 25^\circ\text{C}$	–	–	0.01	mA
		$T_J = 125^\circ\text{C}$	–	–	5.0	

Electrical Characteristics - ON ($T_J = 25^\circ\text{C}$ unless otherwise noted; Electricals apply in both directions)

Characteristic	Symbol	Min	Typ	Max	Unit	
Peak On-State Voltage (Note 4) ($I_{TM} = 16$ A)	V_{TM}	–	1.4	1.8	V	
Gate Trigger Current (Continuous dc) (Note 5) ($V_{AK} = 12$ Vdc, $R_L = 100$ Ω)	I_{GT}	$(T_J = 25^\circ\text{C})$	2.0	7.0	15	μA
		$(T_J = -40^\circ\text{C})$	–	–	30	
Gate Trigger Voltage (Continuous dc) ($V_D = 12$ V, $R_L = 100$ Ω) ($V_D = 12$ V, $R_L = 100$ Ω) (Note 5)	V_{GT}	$(T_J = 25^\circ\text{C})$	0.5	0.65	1.0	V
		$(T_J = -40^\circ\text{C})$	–	–	2.0	
		$(T_J = 125^\circ\text{C})$	0.2	–	–	
Holding Current ($V_D = 12$ V, Initiating Current = 200 mA, $R_{GK} = 1$ k Ω)	I_H	$(T_J = 25^\circ\text{C})$	4.0	22	30	mA
		$(T_J = -40^\circ\text{C})$	–	–	60	
Latching Current ($V_D = 12$ V, $I_G = 2.0$ mA, $R_{GK} = 1$ k Ω)	I_L	$(T_J = 25^\circ\text{C})$	4.0	22	30	mA
		$(T_J = -40^\circ\text{C})$	–	–	60	

Dynamic Characteristics

Characteristic	Symbol	Min	Typ	Max	Unit
Critical Rate of Rise of Off-State Voltage ($V_{AK} = \text{Rated } V_{DRM}, \text{ Exponential Waveform, Gate Open, } T_J = 125^\circ\text{C}$)	dv/dt	50	200	–	V/ μs
Critical Rate of Rise of On-State Current (IPK = 50 A, Pw = 40 sec, $di/dt = 1$ A/sec, $I_{gt} = 50$ mA)	di/dt	–	–	50	A/ms

- Surface mounted on minimum recommended pad size.
- 1/8" from case for 10 seconds.
- Pulse Test; Pulse Width ≤ 2.0 msec, Duty Cycle $\leq 2\%$.

Voltage Current Characteristic of SCR

Symbol	Parameter
V_{DRM}	Peak Repetitive Forward Off State Voltage
I_{DRM}	Peak Forward Blocking Current
V_{RRM}	Peak Repetitive Reverse Off State Voltage
I_{RRM}	Peak Reverse Blocking Current
V_{TM}	Maximum On State Voltage
I_H	Holding Current

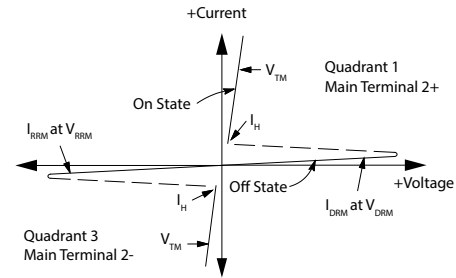

Figure 1. Average Current Derating

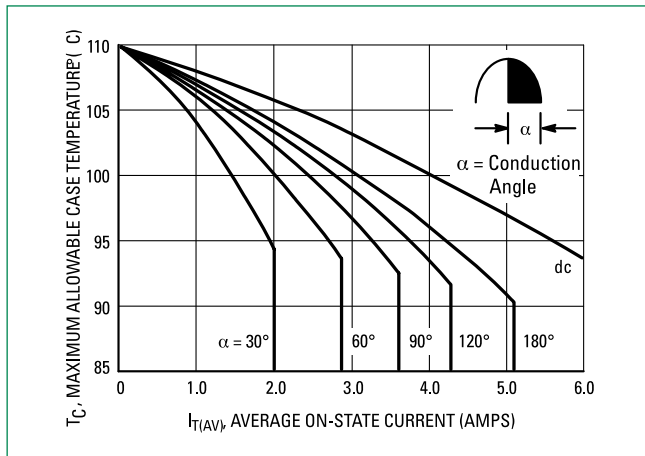

Figure 2. On-State Power Dissipation

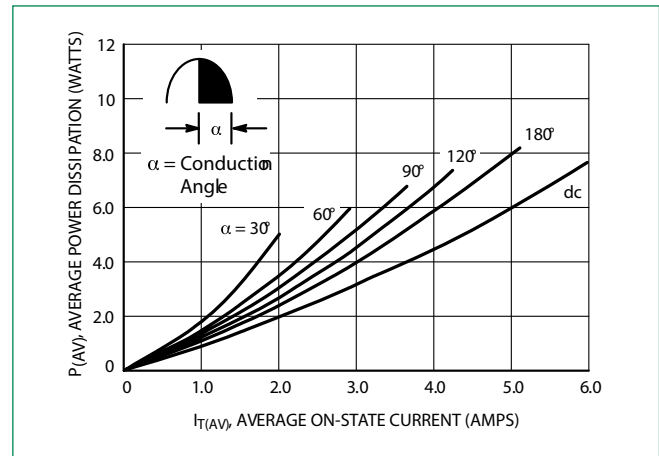

Figure 3. On-State Characteristics

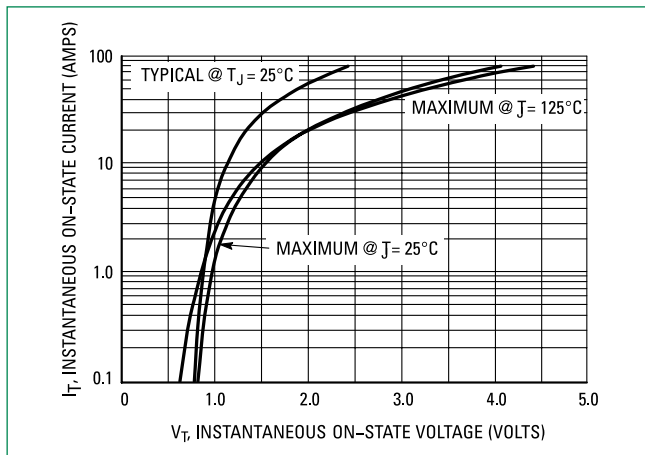

Figure 4. Transient Thermal Response

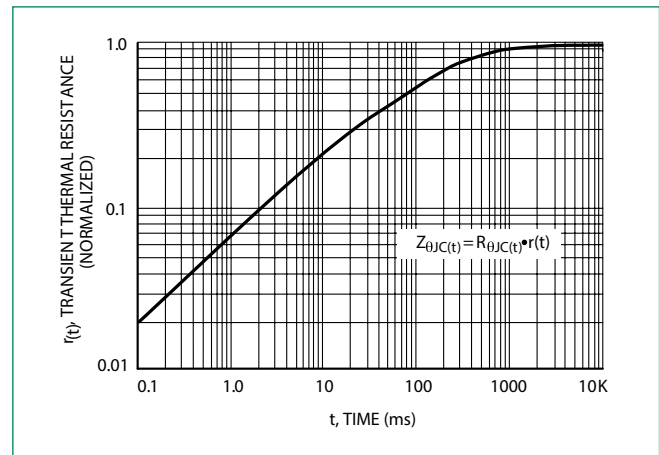

Figure 5. Typical Gate Trigger Current vs Junction Temperature

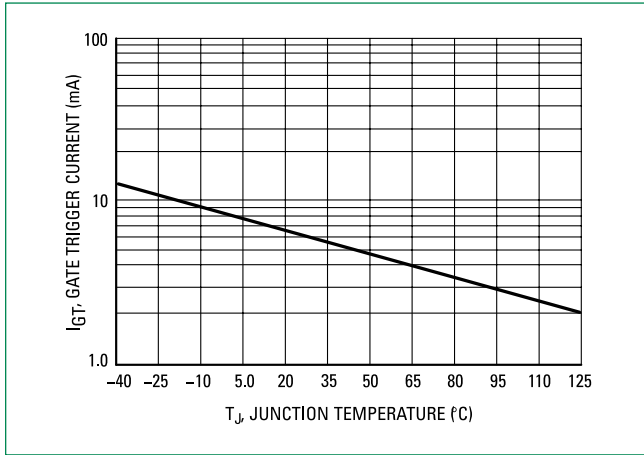

Figure 6. Typical Gate Trigger Voltage vs Junction Temperature

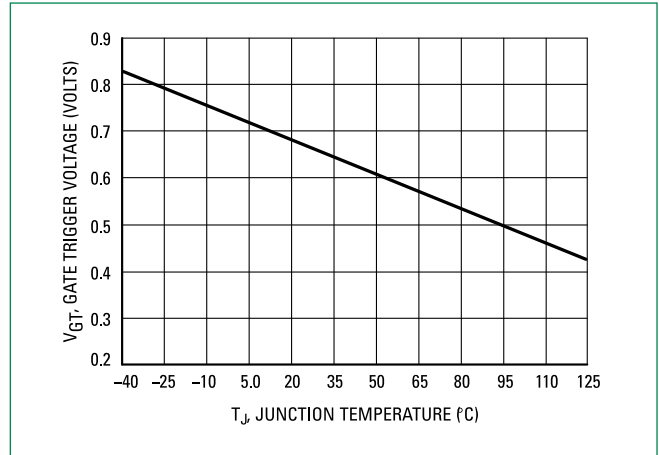

Figure 7. Typical Holding Current vs Junction Temperature

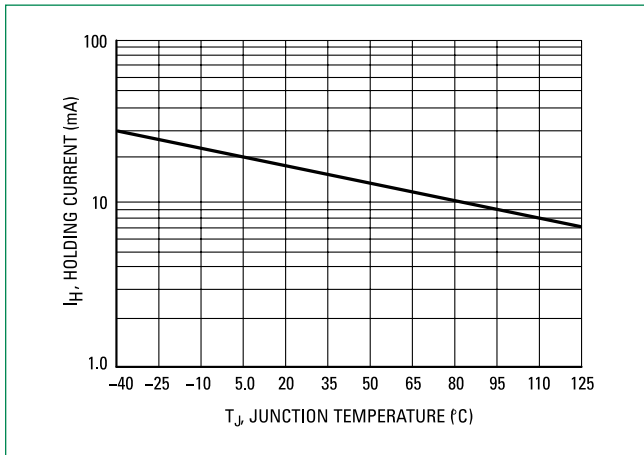

Figure 8. Typical Latching Current vs Junction Temperature

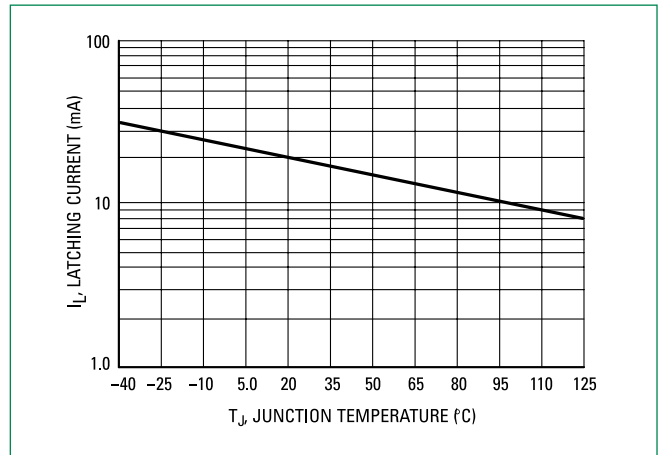
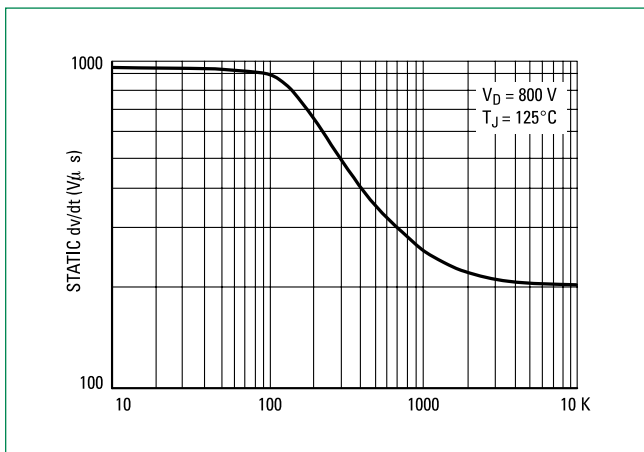
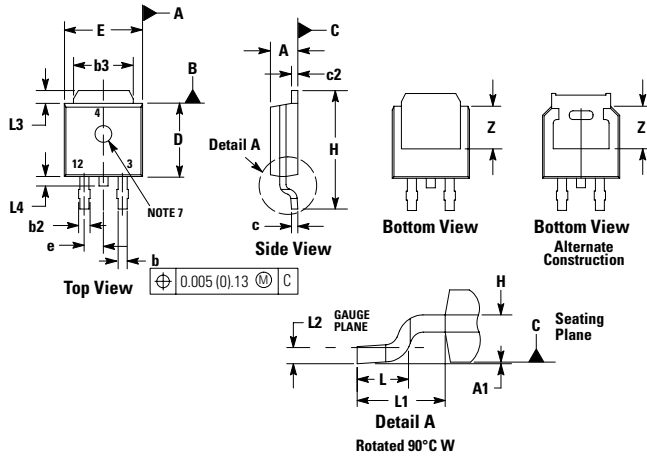

Figure 9. Exponential Static dv/dt vs Gate-Cathode Resistance



Dimensions



Dim	Inches		Millimeters	
	Min	Max	Min	Max
A	0.087	0.094	2.20	2.40
A1	0.000	0.005	0.00	0.12
b	0.022	0.030	0.55	0.75
b2	0.026	0.033	0.65	0.85
b3	0.209	0.217	5.30	5.50
c	0.019	0.023	0.49	0.59
c2	0.019	0.023	0.49	0.59
D	0.213	0.224	5.40	5.70
E	0.252	0.260	6.40	6.60
e	0.091		2.30	
H	0.374	0.406	9.50	10.30
L	0.058	0.070	1.47	1.78
L1	0.114		2.90	
L2	0.019	0.023	0.49	0.59
L3	0.053	0.065	1.35	1.65
L4	0.028	0.039	0.70	1.00
Z	0.154	-	3.90	-

1. DIMENSIONING AND TOLERANCING PER ANSI Y14.5M, 1982.
2. CONTROLLING DIMENSION: INCH.

Soldering Footprint

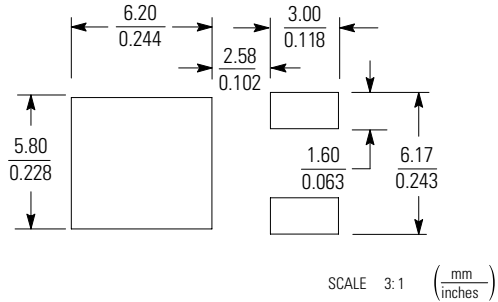

Part Marking System

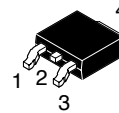

DPAK-3
Case 369C
Style 4

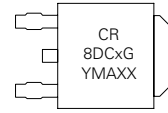

Y = Year
M = Month
A = Assembly Site
AKA = Diode Polarity
G = Pb-Free Package

Pin Assignment

1	Cathode
2	Anode
3	Gate
4	Anode

Ordering Information

Device	Package	Shipping
MCR8DSMT4	DPAK	2500 / Tape & Reel
MCR8DCMT4G	DPAK (Pb-Free)	
MCR8DCNT4	DPAK	
MCR8DCNT4G	DPAK (Pb-Free)	

Disclaimer Notice - Information furnished is believed to be accurate and reliable. However, users should independently evaluate the suitability of and test each product selected for their own applications. Littelfuse products are not designed for, and may not be used in, all applications. Read complete Disclaimer Notice at: www.littelfuse.com/disclaimer-electronics

Mouser Electronics

Authorized Distributor

Click to View Pricing, Inventory, Delivery & Lifecycle Information:

[Littelfuse:](#)

[MCR8DCNT4G](#) [MCR8DCMT4G](#)