

**ULTRA LOW CURRENT CONSUMPTION AND
LOW DROPOUT CMOS VOLTAGE REGULATOR**

The S-1206 Series is a positive voltage regulator with ultra low current consumption, low dropout voltage, high-accuracy output voltage, and 250 mA output current developed based on CMOS technology.

I/O capacitors are as small as 0.1 μF . S-1206 Series operates at ultra low current consumption of 1.0 μA (typ.).

The built-in low-on-resistance transistor realizes low dropout voltage and a large output current. A built-in overcurrent protection circuit prevents the load current from exceeding the current capacity of the output transistor.

Three packages, SOT-23-3, SOT-89-3, and SNT-6A(H) are available.

Compared with voltage regulators using a conventional CMOS technology, more types of capacitors, including small I/O capacitors, can be used with the S-1206 Series. The S-1206 Series features ultra low current consumption and comes in a small package, making them most suitable for portable equipment.

■ Features

- Output voltage: 1.2 V to 5.2 V, selectable in 0.05 V step
- Input voltage: 1.7 V to 6.5 V
- Output voltage accuracy: $\pm 1.0\%$ (1.2 V to 1.45 V output product: ± 15 mV)
- Dropout voltage: 150 mV typ. (3.0 V output product, $I_{\text{OUT}} = 100$ mA)
- Current consumption: During operation: 1.0 μA typ., 1.5 μA max.
- Output current: Possible to output 250 mA (3.0 V output product, $V_{\text{IN}} \geq V_{\text{OUT(S)}} + 1.0$ V)^{*1}
- Input and output capacitors: A ceramic capacitor of 0.1 μF or more can be used.
- Built-in overcurrent protection circuit: Limits overcurrent of output transistor.
- Operation temperature range: $T_a = -40^\circ\text{C}$ to $+85^\circ\text{C}$
- Lead-free, Sn 100%, halogen-free^{*2}

*1. Attention should be paid to the power dissipation of the package when the output current is large.

*2. Refer to “**■ Product Name Structure**” for details.

■ Applications

- Constant-voltage power supply for battery-powered device
- Constant-voltage power supply for cellular phone
- Constant-voltage power supply for portable equipment

■ Packages

- SOT-23-3
- SOT-89-3
- SNT-6A(H)

■ Block Diagram

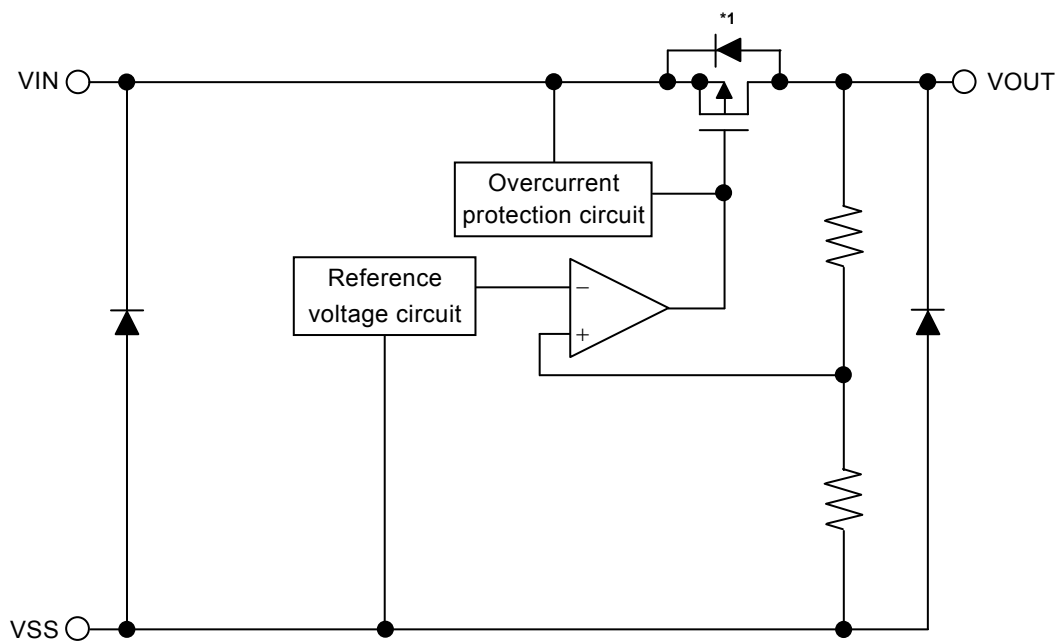

*1. Parasitic diode

Figure 1

■ **Product Name Structure**

The output voltage value and package types for the S-1206 Series can be selected at the user's request. Refer to "1. Product Name" regarding the contents of product name, "2. Packages" regarding the package drawings and "3. Product Name List" regarding details of the product name.

1. Product Name

1.1 SOT-23-3, SOT-89-3

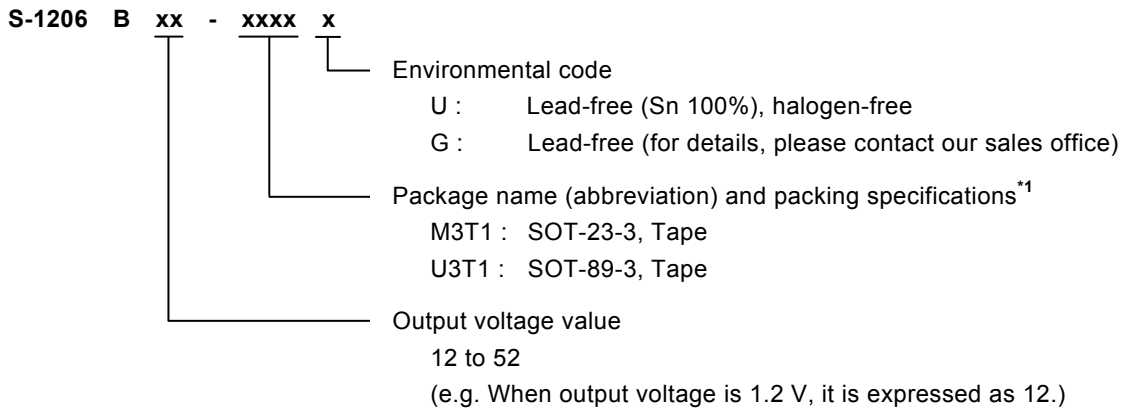

*1. Refer to the tape drawing.

1.2 SNT-6A(H)

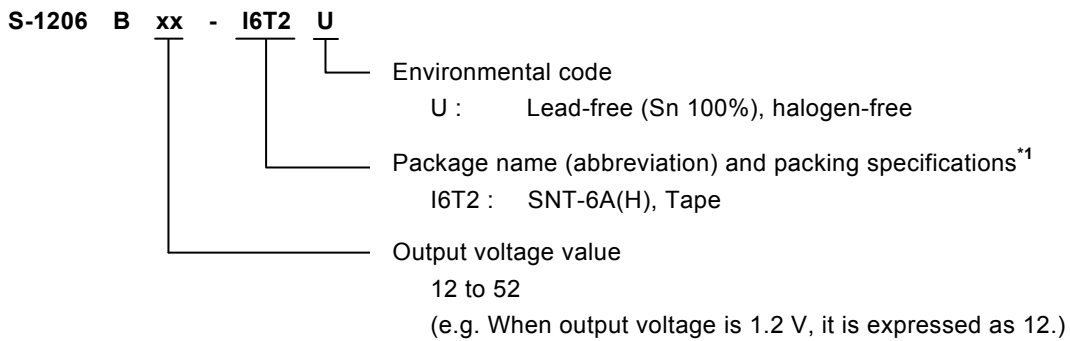

*1. Refer to the tape drawing.

2. Packages

| Package Name | Drawing Code | | | |
|--------------|--------------|--------------|--------------|--------------|
| | Package | Tape | Reel | Land |
| SOT-23-3 | MP003-C-P-SD | MP003-C-C-SD | MP003-Z-R-SD | - |
| SOT-89-3 | UP003-A-P-SD | UP003-A-C-SD | UP003-A-R-SD | - |
| SNT-6A(H) | PI006-A-P-SD | PI006-A-C-SD | PI006-A-R-SD | PI006-A-L-SD |

3. Product Name List

Table 1

| Output Voltage | SOT-23-3 | SOT-89-3 | SNT-6A(H) |
|-------------------|-----------------|-----------------|-----------------|
| 1.2 V \pm 15 mV | S-1206B12-M3T1x | S-1206B12-U3T1x | S-1206B12-I6T2U |
| 1.3 V \pm 15 mV | S-1206B13-M3T1x | S-1206B13-U3T1x | S-1206B13-I6T2U |
| 1.4 V \pm 15 mV | S-1206B14-M3T1x | S-1206B14-U3T1x | S-1206B14-I6T2U |
| 1.5 V \pm 1.0% | S-1206B15-M3T1x | S-1206B15-U3T1x | S-1206B15-I6T2U |
| 1.6 V \pm 1.0% | S-1206B16-M3T1x | S-1206B16-U3T1x | S-1206B16-I6T2U |
| 1.7 V \pm 1.0% | S-1206B17-M3T1x | S-1206B17-U3T1x | S-1206B17-I6T2U |
| 1.8 V \pm 1.0% | S-1206B18-M3T1x | S-1206B18-U3T1x | S-1206B18-I6T2U |
| 1.85 V \pm 1.0% | S-1206B1J-M3T1x | S-1206B1J-U3T1x | S-1206B1J-I6T2U |
| 1.9 V \pm 1.0% | S-1206B19-M3T1x | S-1206B19-U3T1x | S-1206B19-I6T2U |
| 2.0 V \pm 1.0% | S-1206B20-M3T1x | S-1206B20-U3T1x | S-1206B20-I6T2U |
| 2.1 V \pm 1.0% | S-1206B21-M3T1x | S-1206B21-U3T1x | S-1206B21-I6T2U |
| 2.2 V \pm 1.0% | S-1206B22-M3T1x | S-1206B22-U3T1x | S-1206B22-I6T2U |
| 2.3 V \pm 1.0% | S-1206B23-M3T1x | S-1206B23-U3T1x | S-1206B23-I6T2U |
| 2.4 V \pm 1.0% | S-1206B24-M3T1x | S-1206B24-U3T1x | S-1206B24-I6T2U |
| 2.5 V \pm 1.0% | S-1206B25-M3T1x | S-1206B25-U3T1x | S-1206B25-I6T2U |
| 2.6 V \pm 1.0% | S-1206B26-M3T1x | S-1206B26-U3T1x | S-1206B26-I6T2U |
| 2.7 V \pm 1.0% | S-1206B27-M3T1x | S-1206B27-U3T1x | S-1206B27-I6T2U |
| 2.8 V \pm 1.0% | S-1206B28-M3T1x | S-1206B28-U3T1x | S-1206B28-I6T2U |
| 2.85 V \pm 1.0% | S-1206B2J-M3T1x | S-1206B2J-U3T1x | S-1206B2J-I6T2U |
| 2.9 V \pm 1.0% | S-1206B29-M3T1x | S-1206B29-U3T1x | S-1206B29-I6T2U |
| 3.0 V \pm 1.0% | S-1206B30-M3T1x | S-1206B30-U3T1x | S-1206B30-I6T2U |
| 3.1 V \pm 1.0% | S-1206B31-M3T1x | S-1206B31-U3T1x | S-1206B31-I6T2U |
| 3.2 V \pm 1.0% | S-1206B32-M3T1x | S-1206B32-U3T1x | S-1206B32-I6T2U |
| 3.3 V \pm 1.0% | S-1206B33-M3T1x | S-1206B33-U3T1x | S-1206B33-I6T2U |
| 3.4 V \pm 1.0% | S-1206B34-M3T1x | S-1206B34-U3T1x | S-1206B34-I6T2U |
| 3.5 V \pm 1.0% | S-1206B35-M3T1x | S-1206B35-U3T1x | S-1206B35-I6T2U |
| 3.6 V \pm 1.0% | S-1206B36-M3T1x | S-1206B36-U3T1x | S-1206B36-I6T2U |
| 3.7 V \pm 1.0% | S-1206B37-M3T1x | S-1206B37-U3T1x | S-1206B37-I6T2U |
| 3.8 V \pm 1.0% | S-1206B38-M3T1x | S-1206B38-U3T1x | S-1206B38-I6T2U |
| 3.9 V \pm 1.0% | S-1206B39-M3T1x | S-1206B39-U3T1x | S-1206B39-I6T2U |
| 4.0 V \pm 1.0% | S-1206B40-M3T1x | S-1206B40-U3T1x | S-1206B40-I6T2U |
| 4.1 V \pm 1.0% | S-1206B41-M3T1x | S-1206B41-U3T1x | S-1206B41-I6T2U |
| 4.2 V \pm 1.0% | S-1206B42-M3T1x | S-1206B42-U3T1x | S-1206B42-I6T2U |
| 4.3 V \pm 1.0% | S-1206B43-M3T1x | S-1206B43-U3T1x | S-1206B43-I6T2U |
| 4.4 V \pm 1.0% | S-1206B44-M3T1x | S-1206B44-U3T1x | S-1206B44-I6T2U |
| 4.5 V \pm 1.0% | S-1206B45-M3T1x | S-1206B45-U3T1x | S-1206B45-I6T2U |
| 4.6 V \pm 1.0% | S-1206B46-M3T1x | S-1206B46-U3T1x | S-1206B46-I6T2U |
| 4.7 V \pm 1.0% | S-1206B47-M3T1x | S-1206B47-U3T1x | S-1206B47-I6T2U |
| 4.8 V \pm 1.0% | S-1206B48-M3T1x | S-1206B48-U3T1x | S-1206B48-I6T2U |
| 4.9 V \pm 1.0% | S-1206B49-M3T1x | S-1206B49-U3T1x | S-1206B49-I6T2U |
| 5.0 V \pm 1.0% | S-1206B50-M3T1x | S-1206B50-U3T1x | S-1206B50-I6T2U |
| 5.1 V \pm 1.0% | S-1206B51-M3T1x | S-1206B51-U3T1x | S-1206B51-I6T2U |
| 5.2 V \pm 1.0% | S-1206B52-M3T1x | S-1206B52-U3T1x | S-1206B52-I6T2U |

- Remark 1.** Please contact our sales office for products with output voltage values other than the above.
2. x: G or U
3. Please select products of environmental code = U for Sn 100%, halogen-free products.

■ Pin Configurations

SOT-23-3
 Top view

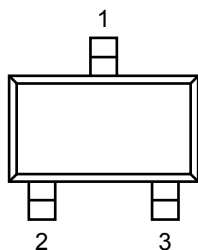

Figure 2

Table 2

| Pin No. | Symbol | Description |
|---------|--------|--------------------|
| 1 | VIN | Input voltage pin |
| 2 | VSS | GND pin |
| 3 | VOOUT | Output voltage pin |

SOT-89-3
 Top view

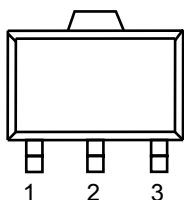

Figure 3

Table 3

| Pin No. | Symbol | Description |
|---------|--------|--------------------|
| 1 | VSS | GND pin |
| 2 | VIN | Input voltage pin |
| 3 | VOOUT | Output voltage pin |

SNT-6A(H)
 Top view

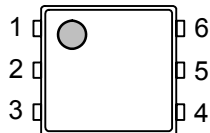

Figure 4

Table 4

| Pin No. | Symbol | Description |
|---------|--------|--------------------|
| 1 | VOOUT | Output voltage pin |
| 2 | VIN | Input voltage pin |
| 3 | VSS | GND pin |
| 4 | NC*1 | No connection |
| 5 | VIN | Input voltage pin |
| 6 | NC*1 | No connection |

*1. The NC pin is electrically open.
 The NC pin can be connected to VIN or VSS.

■ Absolute Maximum Ratings

Table 5

(Ta = 25°C unless otherwise specified)

| Item | Symbol | Absolute Maximum Rating | Unit |
|-------------------------------|-----------|----------------------------------|------|
| Input voltage | V_{IN} | $V_{SS} - 0.3$ to $V_{SS} + 7$ | V |
| Output voltage | V_{OUT} | $V_{SS} - 0.3$ to $V_{IN} + 0.3$ | V |
| Power dissipation | SOT-23-3 | 430 ^{*1} | mW |
| | SOT-89-3 | 1000 ^{*1} | mW |
| | SNT-6A(H) | 500 ^{*1} | mW |
| Operation ambient temperature | T_{opr} | -40 to +85 | °C |
| Storage temperature | T_{sta} | -40 to +125 | °C |

*1. When mounted on board

[Mounted board]

- (1) Board size : 114.3 mm × 76.2 mm × t1.6 mm
- (2) Board name : JEDEC STANDARD51-7

Caution The absolute maximum ratings are rated values exceeding which the product could suffer physical damage. These values must therefore not be exceeded under any conditions.

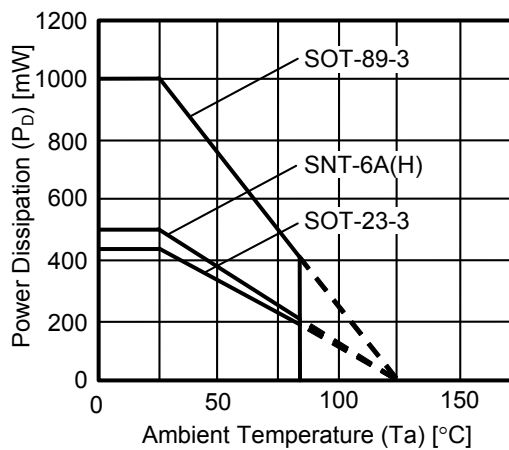

Figure 5 Power Dissipation of Package (When Mounted on Board)

■ Electrical Characteristics

Table 6

(Ta = 25°C unless otherwise specified)

| Item | Symbol | Conditions | Min. | Typ. | Max. | Unit | Test Circuit | |
|--|---|---|-------------------------------------|---------------------|-------------------------------|--------|--------------|---|
| Output voltage*1 | V _{OUT(E)} | V _{IN} = V _{OUT(S)} + 1.0 V, I _{OUT} = 30 mA, 1.2 V ≤ V _{OUT(S)} < 1.5 V | V _{OUT(S)} -15 mV | V _{OUT(S)} | V _{OUT(S)} +15 mV | V | 1 | |
| | | V _{IN} = V _{OUT(S)} + 1.0 V, I _{OUT} = 30 mA, 1.5 V ≤ V _{OUT(S)} | V _{OUT(S)} × 0.99 | V _{OUT(S)} | V _{OUT(S)} × 1.01 | V | 1 | |
| Output current*2 | I _{OUT} | V _{IN} ≥ V _{OUT(S)} + 1.0 V, 1.2 V ≤ V _{OUT(S)} < 1.5 V | 150*5 | – | – | mA | 3 | |
| | | V _{IN} ≥ V _{OUT(S)} + 1.0 V, 1.5 V ≤ V _{OUT(S)} | 250*5 | – | – | mA | 3 | |
| Dropout voltage*3 | V _{drop} | I _{OUT} = 100 mA | 1.2 V ≤ V _{OUT(S)} < 1.3 V | 0.5 | 0.54 | 0.81 | V | 1 |
| | | | 1.3 V ≤ V _{OUT(S)} < 1.4 V | – | 0.50 | 0.73 | V | 1 |
| | | | 1.4 V ≤ V _{OUT(S)} < 1.5 V | – | 0.43 | 0.66 | V | 1 |
| | | | 1.5 V ≤ V _{OUT(S)} < 1.7 V | – | 0.35 | 0.53 | V | 1 |
| | | | 1.7 V ≤ V _{OUT(S)} < 1.9 V | – | 0.33 | 0.50 | V | 1 |
| | | | 1.9 V ≤ V _{OUT(S)} < 2.1 V | – | 0.26 | 0.43 | V | 1 |
| | | | 2.1 V ≤ V _{OUT(S)} < 3.0 V | – | 0.23 | 0.36 | V | 1 |
| | | | 3.0 V ≤ V _{OUT(S)} ≤ 5.2 V | – | 0.15 | 0.23 | V | 1 |
| Line regulation | $\frac{\Delta V_{OUT1}}{\Delta V_{IN} \bullet V_{OUT}}$ | V _{OUT(S)} + 0.5 V ≤ V _{IN} ≤ 6.5 V | I _{OUT} = 1 μA | – | 0.05 | 0.2 | %/V | 1 |
| | | | I _{OUT} = 30 mA | – | 0.05 | 0.2 | %/V | 1 |
| Load regulation | ΔV _{OUT2} | V _{IN} = V _{OUT(S)} + 1.0 V, 1 μA ≤ I _{OUT} ≤ 100 mA | – | 20 | 40 | mV | 1 | |
| Output voltage temperature coefficient*4 | $\frac{\Delta V_{OUT}}{\Delta Ta \bullet V_{OUT}}$ | V _{IN} = V _{OUT(S)} + 1.0 V, I _{OUT} = 30 mA, -40°C ≤ Ta ≤ 85°C | – | ±120 | – | ppm/°C | 1 | |
| Current consumption during operation | I _{SS1} | V _{IN} = V _{OUT(S)} + 1.0 V, no load | – | 1.0 | 1.5 | μA | 2 | |
| Input voltage | V _{IN} | – | 1.7 | – | 6.5 | V | – | |
| Short-circuit current | I _{SHORT} | V _{IN} = V _{OUT(S)} + 1.0 V, V _{OUT} = 0 V | 1.2 V ≤ V _{OUT} < 2.3 V | – | 130 | – | mA | 3 |
| | | | 2.3 V ≤ V _{OUT} ≤ 5.2 V | – | 100 | – | mA | 3 |

*1. V_{OUT(S)} : Set output voltage

V_{OUT(E)} : Actual output voltage

Output voltage when fixing I_{OUT} (= 30 mA) and inputting V_{OUT(S)} + 1.0 V

*2. The output current at which the output voltage becomes 95% of V_{OUT(E)} after gradually increasing the output current.

*3. V_{drop} = V_{IN1} - (V_{OUT3} × 0.98)

V_{OUT3} is the output voltage when V_{IN} = V_{OUT(S)} + 1.0 V and I_{OUT} = 100 mA.

V_{IN1} is the input voltage at which the output voltage becomes 98% of V_{OUT3} after gradually decreasing the input voltage.

*4. A change in the temperature of the output voltage [mV/°C] is calculated using the following equation.

$$\frac{\Delta V_{OUT}}{\Delta Ta} \text{ [mV/°C]}^*1 = V_{OUT(S)} \text{ [V]}^*2 \times \frac{\Delta V_{OUT}}{\Delta Ta \bullet V_{OUT}} \text{ [ppm/°C]}^*3 \div 1000$$

*1. Change in temperature of output voltage

*2. Set output voltage

*3. Output voltage temperature coefficient

*5. The output current can be at least this value.

Due to restrictions on the package power dissipation, this value may not be satisfied. Attention should be paid to the power dissipation of the package when the output current is large.

This specification is guaranteed by design.

■ Test Circuits

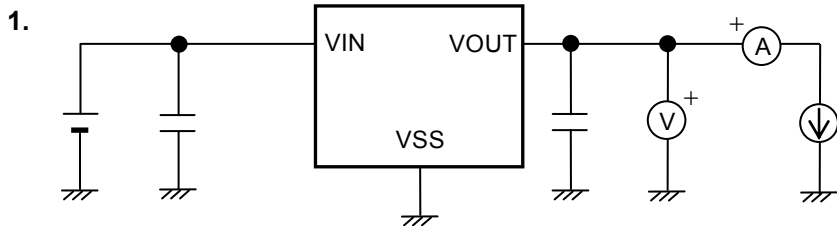

Figure 6

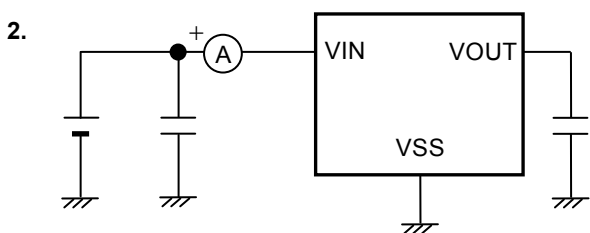

Figure 7

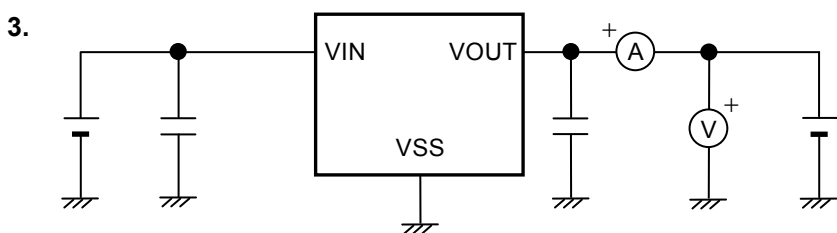
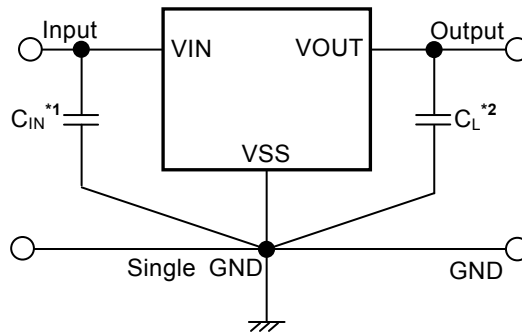

Figure 8

■ **Standard Circuit**



- *1. A capacitor for stabilizing the input.
- *2. A ceramic capacitor of 0.1 μF or more can be used.

Figure 9

Caution The above connection diagram and constant will not guarantee successful operation. Perform thorough evaluation using the actual application to set the constant.

■ **Condition of Application**

Input capacitor (C_{IN}): 0.1 μF or more
 Output capacitor (C_L): 0.1 μF or more

Caution Generally a series regulator may cause oscillation, depending on the selection of external parts. Confirm that no oscillation occurs in the application for which the above capacitors are used.

■ **Selection of Input and Output Capacitors (C_{IN} , C_L)**

The S-1206 Series requires an output capacitor between the VOUT pin and VSS pin for phase compensation. Operation is stabilized by a ceramic capacitor with an output capacitance of 0.1 μF or more in the entire temperature range. When using an OS capacitor, a tantalum capacitor, or an aluminum electrolytic capacitor, the capacitance must be 0.1 μF or more.

The value of the output overshoot or undershoot transient response varies depending on the value of the output capacitor.

The required capacitance of the input capacitor differs depending on the application.

The recommended value for an application is $C_{IN} \geq 0.1 \mu\text{F}$, $C_L \geq 0.1 \mu\text{F}$; however, when selecting these capacitors, perform sufficient evaluation, including evaluation of temperature characteristics, on the actual device.

■ Explanation of Terms

1. Low Dropout Voltage Regulator

This voltage regulator has the low dropout voltage due to its built-in low on-resistance transistor.

2. Low Equivalent Series Resistance

A capacitor whose equivalent series resistance (R_{ESR}) is low. The S-1206 Series enables use of a low equivalent series resistance capacitor, such as a ceramic capacitor, for the output-side capacitor (C_L).

3. Output Voltage (V_{OUT})

The accuracy of the output voltage is ensured at $\pm 1.0\%$ or $\pm 15 \text{ mV}^2$ under the specified conditions of fixed input voltage^{*1}, fixed output current, and fixed temperature.

*1. Differs depending on the product.

*2. When $V_{OUT} < 1.5 \text{ V} : \pm 15 \text{ mV}$, When $1.5 \text{ V} \leq V_{OUT} : \pm 1.0\%$

Caution If the above conditions change, the output voltage value may vary and exceed the accuracy range of the output voltage. Refer to the “■ Electrical Characteristics” and “■ Characteristics (Typical Data)” for details.

4. Line Regulation $\left(\frac{\Delta V_{OUT1}}{\Delta V_{IN} \bullet V_{OUT}} \right)$

Indicates the dependency of the output voltage on the input voltage. That is, the values show how much the output voltage changes due to a change in the input voltage with the output current remaining unchanged.

5. Load Regulation (ΔV_{OUT2})

Indicates the dependency of the output voltage on the output current. That is, the values show how much the output voltage changes due to a change in the output current with the input voltage remaining unchanged.

6. Dropout Voltage (V_{drop})

Indicates the difference between input voltage (V_{IN1}) and the output voltage when; decreasing input voltage (V_{IN}) gradually until the output voltage has dropped out to the value of 98% of output voltage (V_{OUT3}), which is at $V_{IN} = V_{OUT(S)} + 1.0 \text{ V}$.

$$V_{drop} = V_{IN1} - (V_{OUT3} \times 0.98)$$

7. Output Voltage Temperature Coefficient $\left(\frac{\Delta V_{OUT}}{\Delta T_a \bullet V_{OUT}} \right)$

The shaded area in **Figure 10** is the range where V_{OUT} varies in the operation temperature range when the output voltage temperature coefficient is ± 120 ppm/ $^{\circ}\text{C}$.

Example of S-1206B30 typ. product

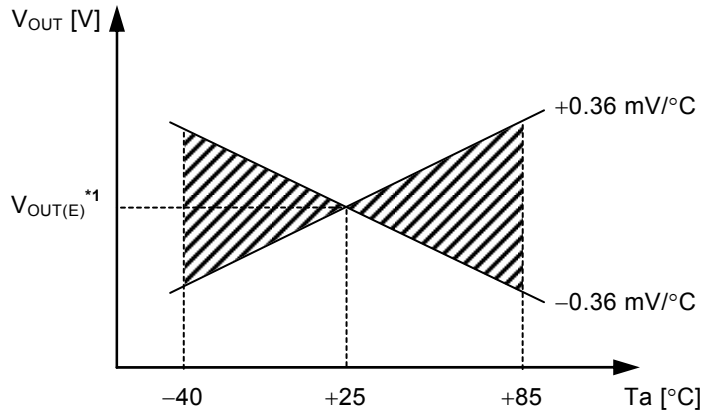

*1. $V_{OUT(E)}$ is the value of the output voltage measured at $T_a = +25^{\circ}\text{C}$.

Figure 10

A change in the temperature of the output voltage [$\text{mV}/^{\circ}\text{C}$] is calculated using the following equation.

$$\frac{\Delta V_{OUT}}{\Delta T_a} [\text{mV}/^{\circ}\text{C}]^{*1} = V_{OUT(S)} [\text{V}]^{*2} \times \frac{\Delta V_{OUT}}{\Delta T_a \bullet V_{OUT}} [\text{ppm}/^{\circ}\text{C}]^{*3} \div 1000$$

- *1. Change in temperature of output voltage
- *2. Set output voltage
- *3. Output voltage temperature coefficient

■ **Operation**

1. Basic Operation

Figure 11 shows the block diagram of the S-1206 Series.

The error amplifier compares the reference voltage (V_{ref}) with feedback voltage (V_{fb}), which is the output voltage resistance-divided by feedback resistors (R_s and R_f). It supplies the gate voltage necessary to maintain the constant output voltage which is not influenced by the input voltage and temperature change, to the output transistor.

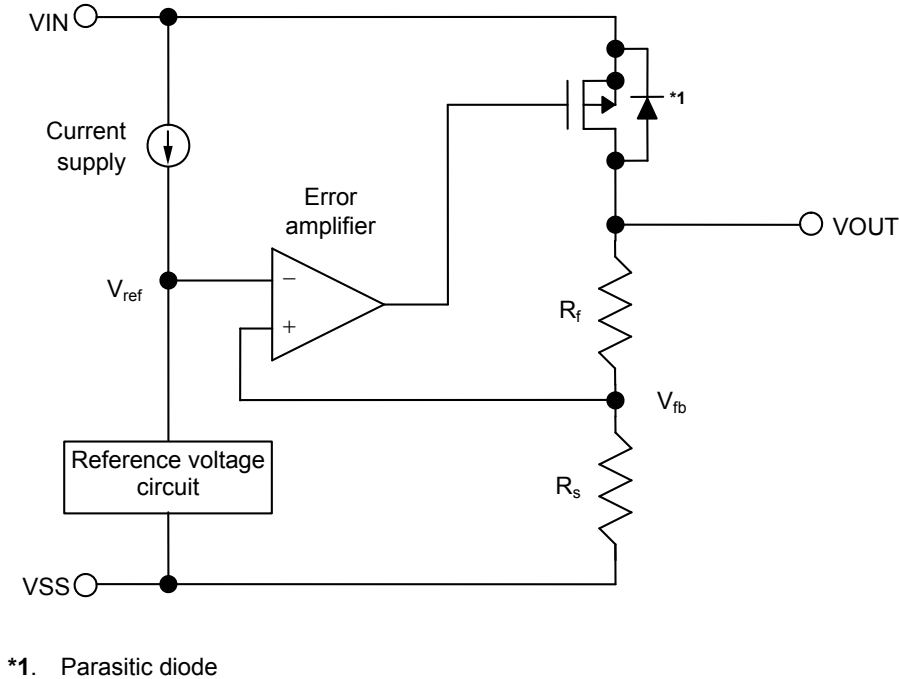

Figure 11

2. Output Transistor

In the S-1206 Series, a low on-resistance P-channel MOS FET is used as the output transistor.

Be sure that V_{OUT} does not exceed $V_{IN} + 0.3$ V to prevent the voltage regulator from being damaged due to reverse current flowing from the VOUT pin through a parasitic diode to the VIN pin, when the potential of V_{OUT} became higher than V_{IN} .

3. Overcurrent Protection Circuit

The S-1206 Series includes an overcurrent protection circuit having the characteristics shown in “1. Output Voltage vs. Output Current ($T_a = 25^\circ\text{C}$)” in “■ Characteristics (Typical Data)”, in order to protect the output transistor against an excessive output current and short circuiting between the VOUT and VSS pins. The current when the output pin is short-circuited (I_{SHORT}) is internally set at approx. 130 mA (typ.) ($1.2\text{ V} \leq V_{OUT} < 2.3\text{ V}$) or approx. 100 mA (typ.) ($2.3\text{ V} \leq V_{OUT} \leq 5.2\text{ V}$), and the normal value is restored for the output voltage, if releasing a short circuit once.

Caution This overcurrent protection circuit does not work as for thermal protection. If this IC long keeps short circuiting inside, pay attention to the conditions of input voltage and load current so that, under the usage conditions including short circuit, the loss of the IC will not exceed power dissipation of the package.

■ Precautions

- Wiring patterns for the VIN pin, the VOUT pin and GND should be designed so that the impedance is low. When mounting an output capacitor between the VOUT pin and the VSS pin (C_L) and a capacitor for stabilizing the input between the VIN pin and the VSS pin (C_{IN}), the distance from the capacitors to these pins should be as short as possible.
- Note that generally the output voltage may increase when a series regulator is used at low load current (10 μ A or less).
- Note that generally the output voltage may increase due to the leakage current from an output driver when a series regulator is used at high temperature.
- Generally a series regulator may cause oscillation, depending on the selection of external parts. The following conditions are recommended for the S-1206 Series. However, be sure to perform sufficient evaluation under the actual usage conditions for selection, including evaluation of temperature characteristics. Refer to “**5. Equivalent Series Resistance vs. Output Current Characteristics Example ($T_a = 25^\circ\text{C}$)**” in “**■ Reference Data**” for the equivalent series resistance (R_{ESR}) of the output capacitor.

| | |
|-------------------------------|---------------------|
| Input capacitor (C_{IN}): | 0.1 μ F or more |
| Output capacitor (C_L): | 0.1 μ F or more |

Use an I/O capacitor with good temperature characteristics (conforming to the ceramic capacitor EIA X5R (JIS B) characteristics).

- The voltage regulator may oscillate when the impedance of the power supply is high and the input capacitance is small or an input capacitor is not connected.
- If the output capacitance is small, power supply's fluctuation and the characteristics of load fluctuation become worse. Sufficiently evaluate the output voltage's fluctuation with the actual device.
- Overshoot may occur in the output voltage momentarily if the voltage is rapidly raised at power-on or when the power supply fluctuates. Sufficiently evaluate the output voltage at power-on with the actual device.
- The application conditions for the input voltage, the output voltage, and the load current should not exceed the package power dissipation.
- Do not apply an electrostatic discharge to this IC that exceeds the performance ratings of the built-in electrostatic protection circuit.
- In determining the output current, attention should be paid to the output current value specified in **Table 6** in “**■ Electrical Characteristics**” and footnote *5 of the table.
- ABLIC Inc. claims no responsibility for any disputes arising out of or in connection with any infringement by products including this IC of patents owned by a third party.

■ **Characteristics (Typical Data)**

1. Output Voltage vs. Output Current (Ta = 25°C)

S-1206B12

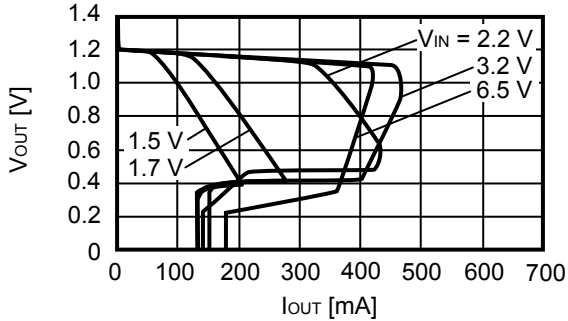

S-1206B30

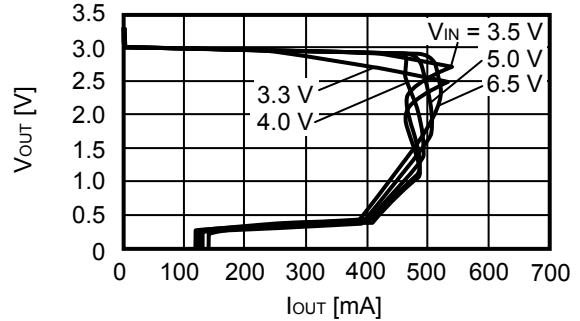

S-1206B50

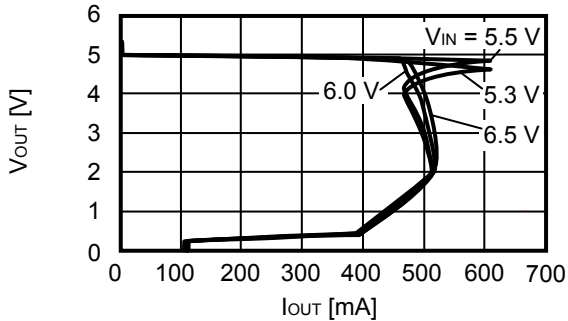

Remark In determining the output current, attention should be paid to the following.

1. Minimum output current value specified in **Table 6** and footnote *5 in "■ **Electrical Characteristics**"
2. Power dissipation of package

2. Output Voltage vs. Input Voltage (Ta = 25°C)

S-1206B12

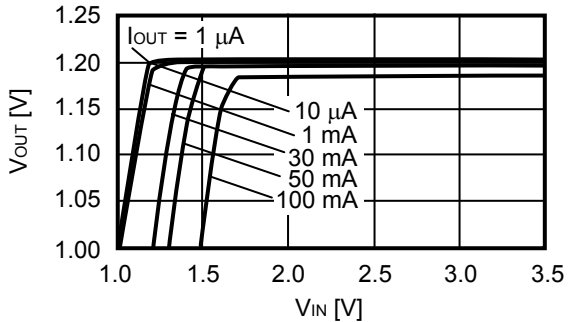

S-1206B30

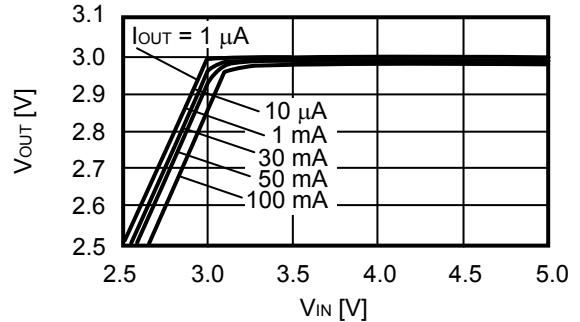

S-1206B50

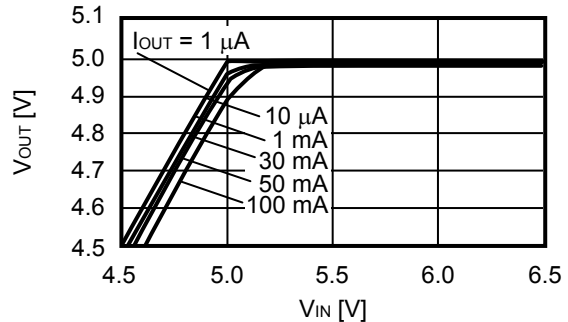

3. Dropout Voltage vs. Output Current

S-1206B12

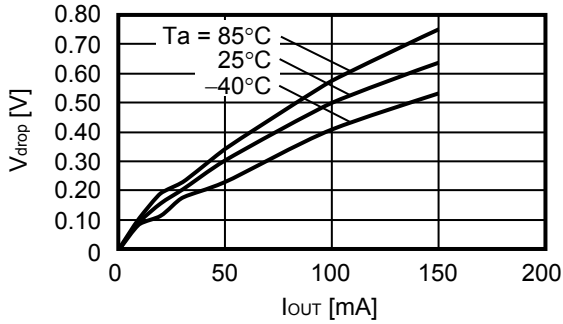

S-1206B30

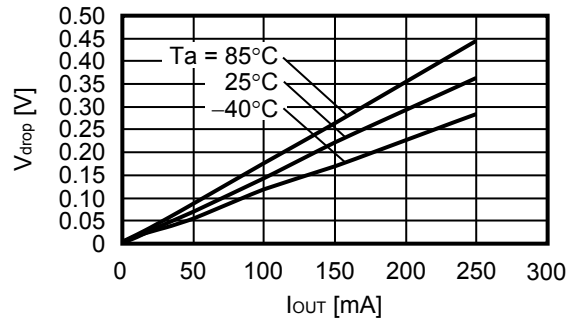

S-1206B50

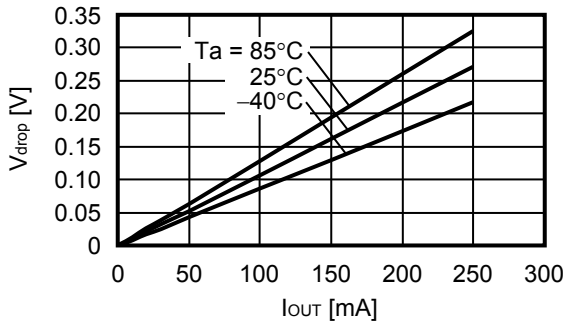

4. Dropout Voltage vs. Set Output Voltage

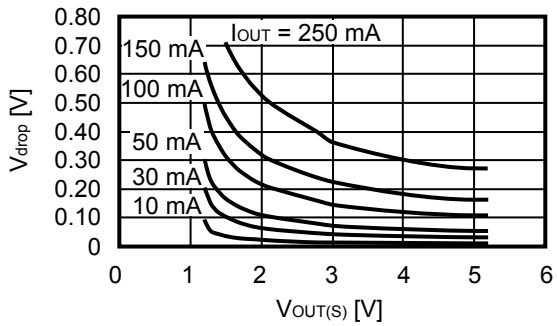

5. Output Voltage vs. Ambient Temperature

S-1206B12

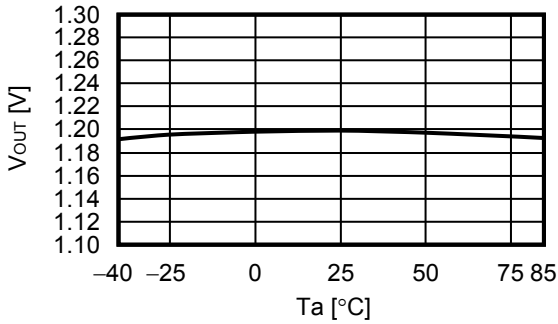

S-1206B30

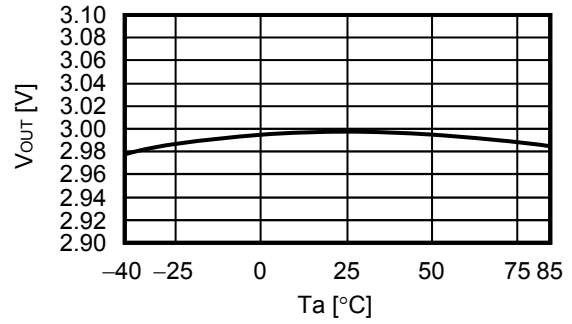

S-1206B50

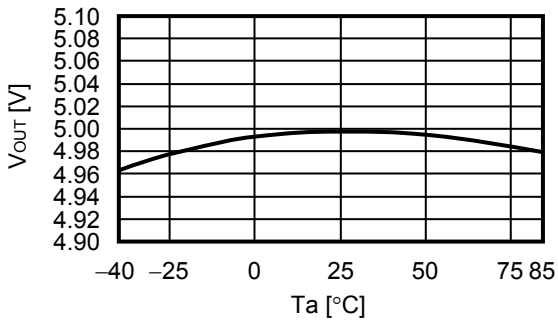

6. Current Consumption vs. Input Voltage

S-1206B12

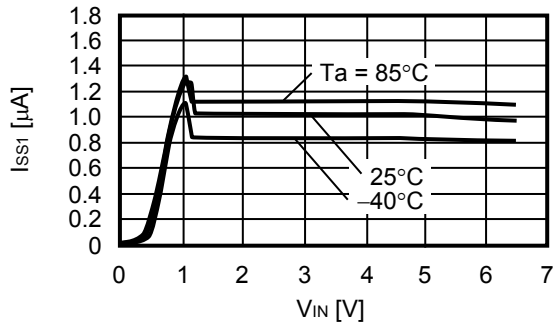

S-1206B30

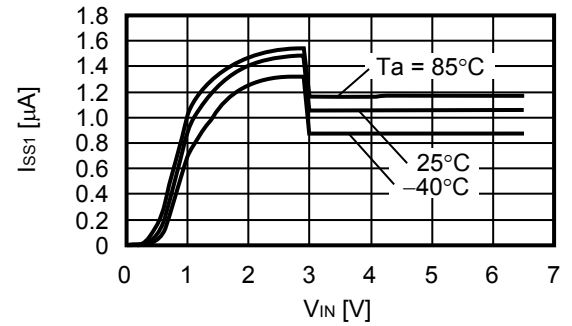

S-1206B50

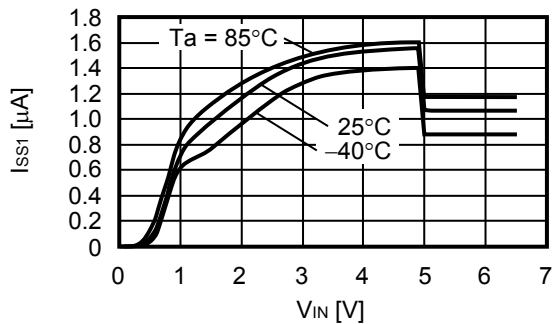

7. Current Consumption vs. Ambient Temperature

S-1206B12

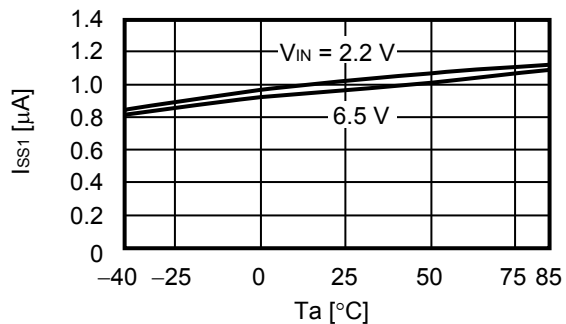

S-1206B30

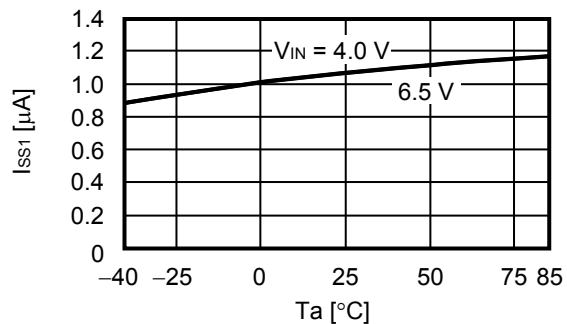

S-1206B50

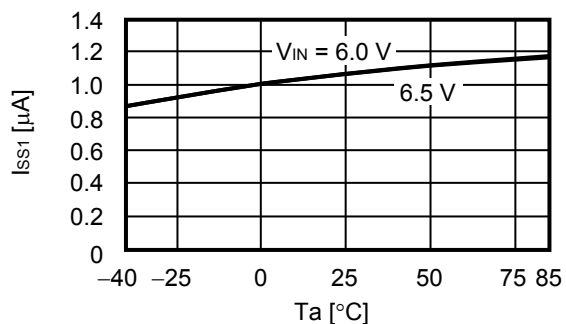

■ Reference Data

1. Input Transient Response Characteristics (Ta = 25°C)

S-1206B12

$I_{OUT} = 1\text{ mA}$, $t_r = t_f = 5.0\ \mu\text{s}$

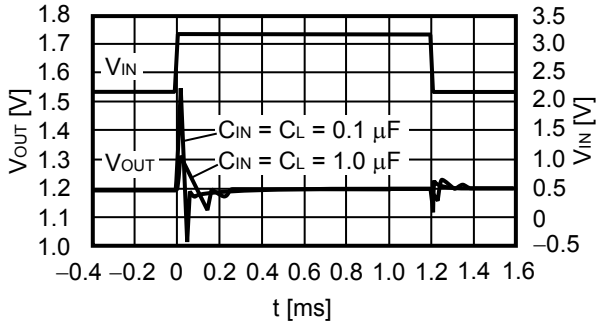

$I_{OUT} = 100\text{ mA}$, $t_r = t_f = 5.0\ \mu\text{s}$

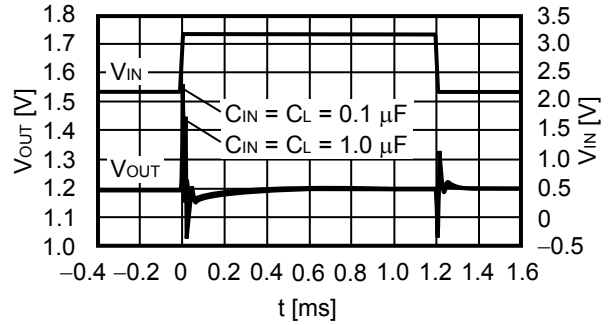

S-1206B30

$I_{OUT} = 1\text{ mA}$, $t_r = t_f = 5.0\ \mu\text{s}$

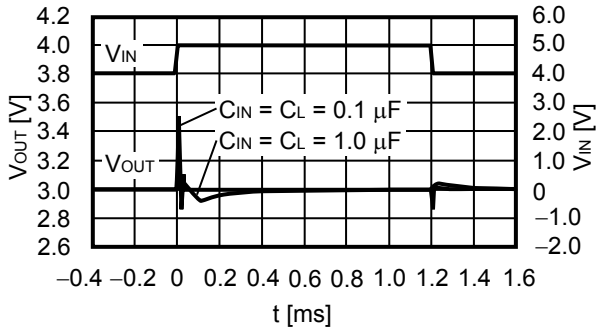

$I_{OUT} = 100\text{ mA}$, $t_r = t_f = 5.0\ \mu\text{s}$

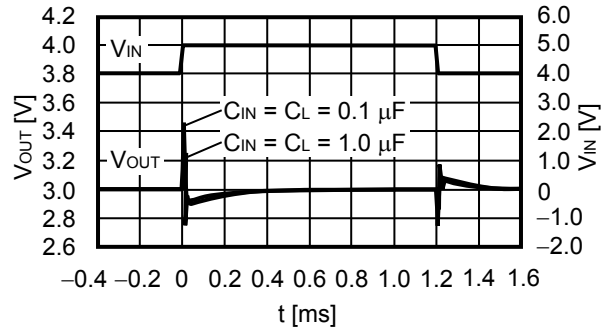

S-1206B50

$I_{OUT} = 1\text{ mA}$, $t_r = t_f = 5.0\ \mu\text{s}$

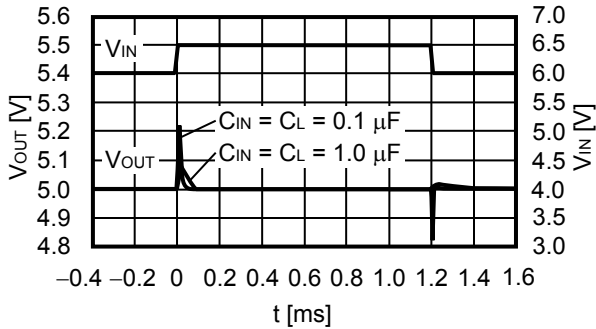

$I_{OUT} = 100\text{ mA}$, $t_r = t_f = 5.0\ \mu\text{s}$

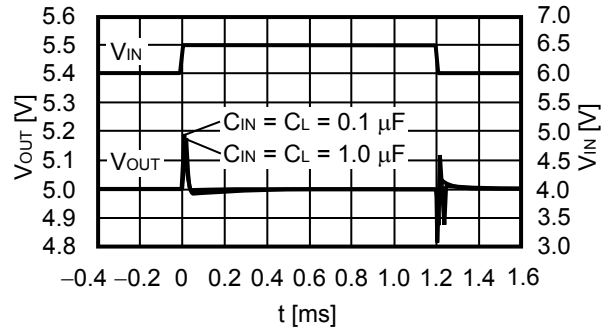

2. Load Transient Response Characteristics (Ta = 25°C)

S-1206B12

$V_{IN} = 2.2\text{ V}$, $I_{OUT} = 1\text{ mA} \leftrightarrow 40\text{ mA}$

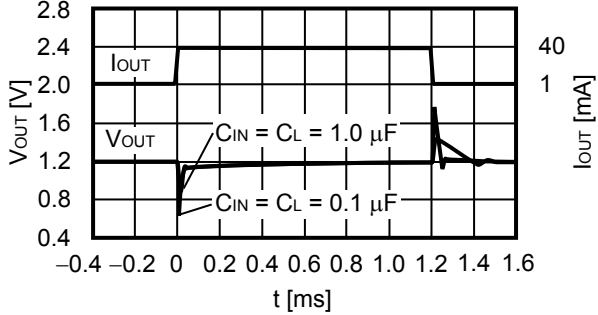

$V_{IN} = 2.2\text{ V}$, $I_{OUT} = 50\text{ mA} \leftrightarrow 100\text{ mA}$

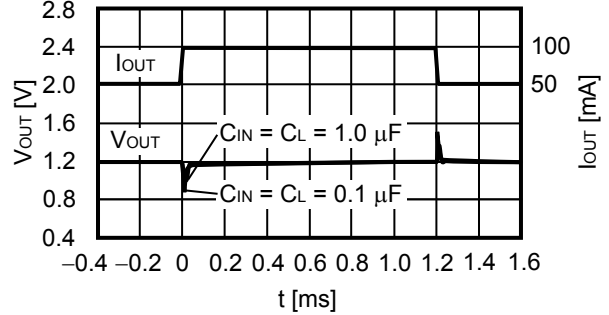

S-1206B30

$V_{IN} = 4.0\text{ V}$, $I_{OUT} = 1\text{ mA} \leftrightarrow 40\text{ mA}$

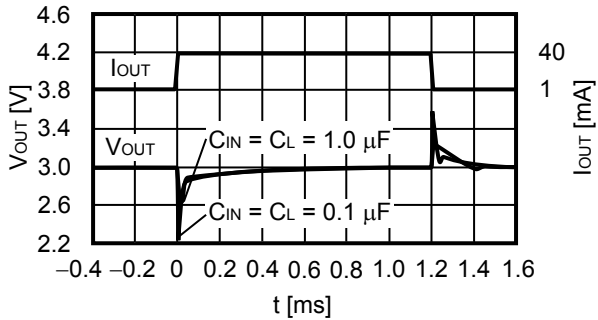

$V_{IN} = 4.0\text{ V}$, $I_{OUT} = 50\text{ mA} \leftrightarrow 100\text{ mA}$

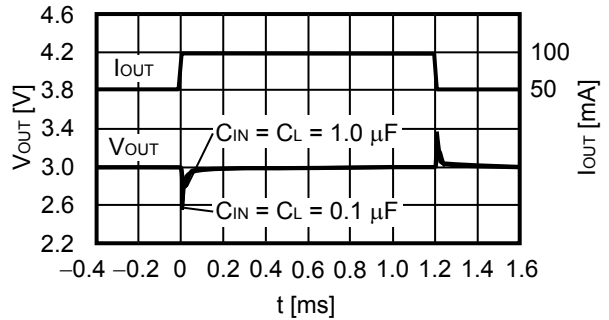

S-1206B50

$V_{IN} = 6.0\text{ V}$, $I_{OUT} = 1\text{ mA} \leftrightarrow 40\text{ mA}$

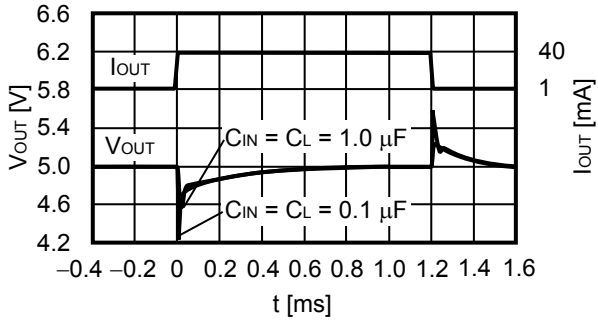

$V_{IN} = 6.0\text{ V}$, $I_{OUT} = 50\text{ mA} \leftrightarrow 100\text{ mA}$

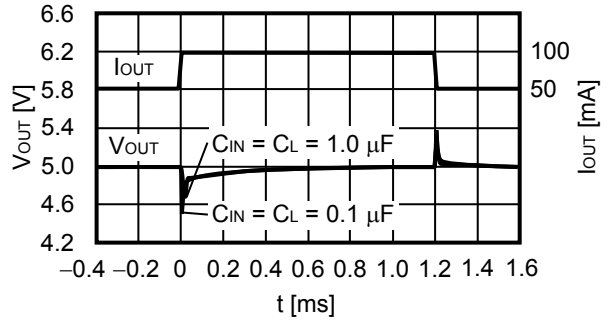

3. Input Voltage Transient Response Characteristics (Ta = 25°C)

S-1206B12

$V_{IN} = 2.2\text{ V}$, $I_{OUT} = 1\text{ mA}$

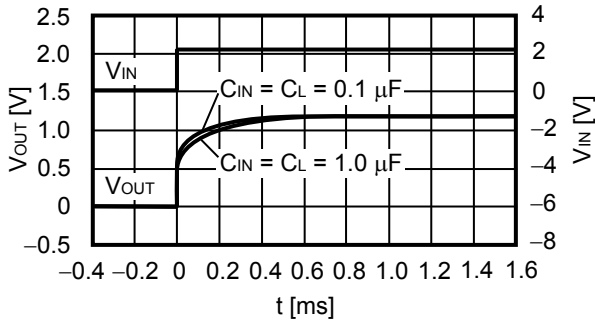

$V_{IN} = 2.2\text{ V}$, $I_{OUT} = 100\text{ mA}$

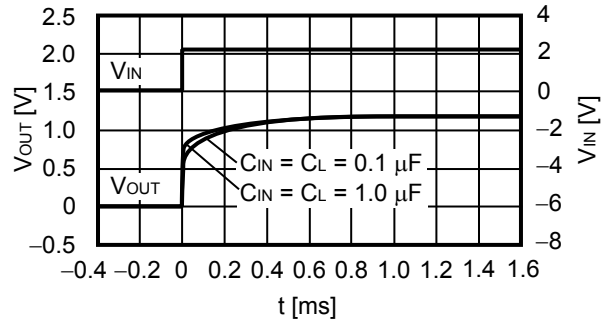

S-1206B30

$V_{IN} = 4.0\text{ V}$, $I_{OUT} = 1\text{ mA}$

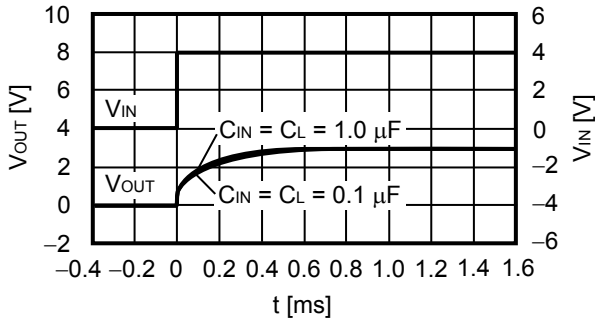

$V_{IN} = 4.0\text{ V}$, $I_{OUT} = 100\text{ mA}$

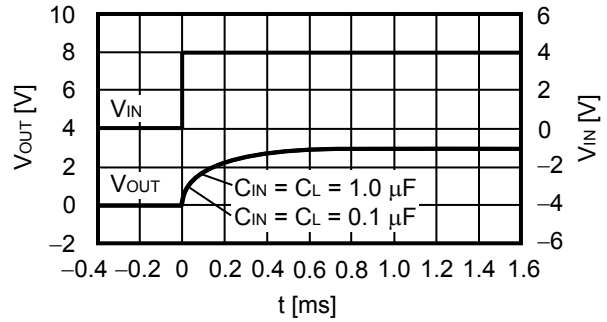

S-1206B50

$V_{IN} = 6.0\text{ V}$, $I_{OUT} = 1\text{ mA}$

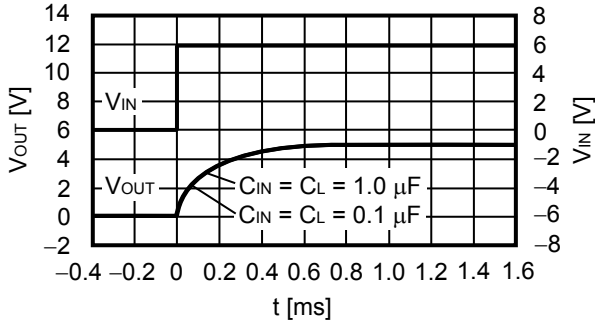

$V_{IN} = 6.0\text{ V}$, $I_{OUT} = 100\text{ mA}$

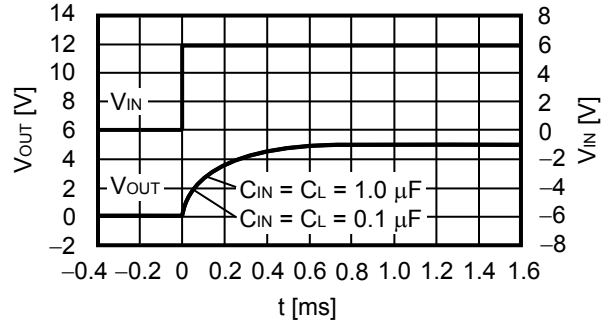

4. Ripple Rejection (Ta = 25°C)

S-1206B12

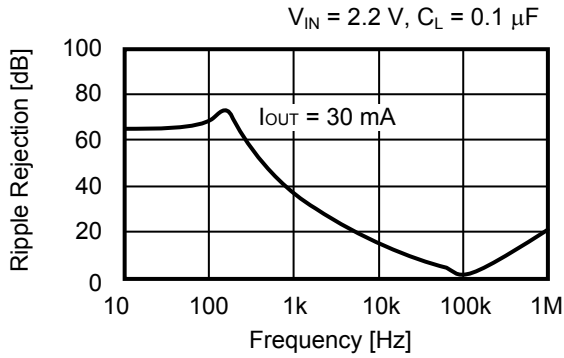

S-1206B30

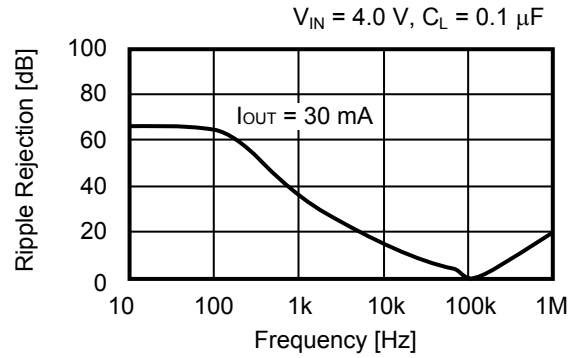

S-1206B50

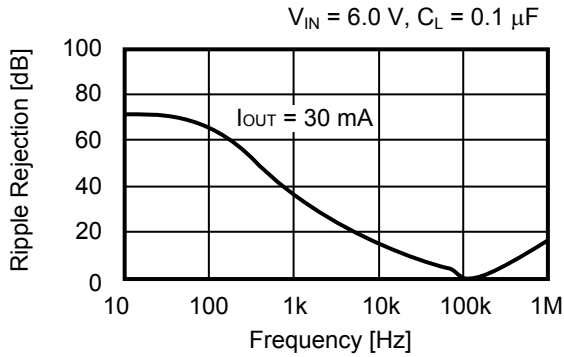

5. Equivalent Series Resistance vs. Output Current Characteristics Example (Ta = 25°C)

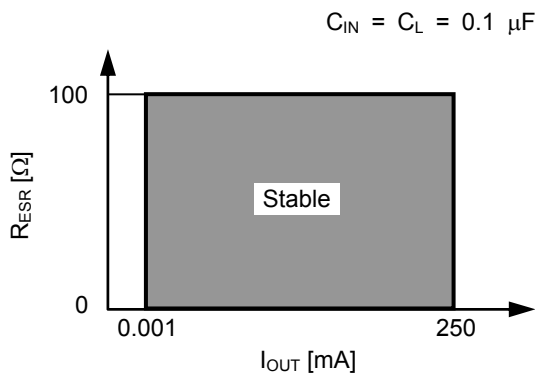

C_L : Murata Manufacturing Co., Ltd.
 GRM115R71C104K (0.1 μF)

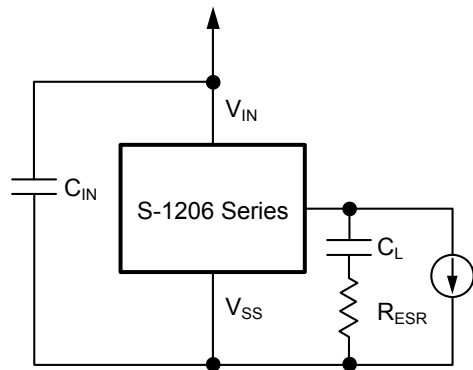

■ Marking Specifications

1. SOT-23-3

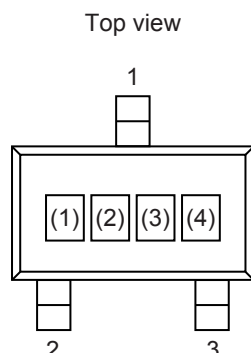

(1) to (3) : Product abbreviation (refer to **Product Name vs. Product Code**)
(4) : Lot number

Product Name vs. Product Code

| Product Name | Product Code | | |
|-----------------|--------------|-----|-----|
| | (1) | (2) | (3) |
| S-1206B12-M3T1x | S | A | A |
| S-1206B13-M3T1x | S | A | B |
| S-1206B14-M3T1x | S | A | C |
| S-1206B15-M3T1x | S | A | D |
| S-1206B16-M3T1x | S | A | E |
| S-1206B17-M3T1x | S | A | F |
| S-1206B18-M3T1x | S | A | G |
| S-1206B1J-M3T1x | S | A | H |
| S-1206B19-M3T1x | S | A | I |
| S-1206B20-M3T1x | S | A | J |
| S-1206B21-M3T1x | S | A | K |
| S-1206B22-M3T1x | S | A | L |
| S-1206B23-M3T1x | S | A | M |
| S-1206B24-M3T1x | S | A | N |
| S-1206B25-M3T1x | S | A | O |
| S-1206B26-M3T1x | S | A | P |
| S-1206B27-M3T1x | S | A | Q |
| S-1206B28-M3T1x | S | A | R |
| S-1206B2J-M3T1x | S | A | S |
| S-1206B29-M3T1x | S | A | T |
| S-1206B30-M3T1x | S | A | U |
| S-1206B31-M3T1x | S | A | V |

| Product Name | Product Code | | |
|-----------------|--------------|-----|-----|
| | (1) | (2) | (3) |
| S-1206B32-M3T1x | S | A | W |
| S-1206B33-M3T1x | S | A | X |
| S-1206B34-M3T1x | S | A | Y |
| S-1206B35-M3T1x | S | A | Z |
| S-1206B36-M3T1x | S | B | A |
| S-1206B37-M3T1x | S | B | B |
| S-1206B38-M3T1x | S | B | C |
| S-1206B39-M3T1x | S | B | D |
| S-1206B40-M3T1x | S | B | E |
| S-1206B41-M3T1x | S | B | F |
| S-1206B42-M3T1x | S | B | G |
| S-1206B43-M3T1x | S | B | H |
| S-1206B44-M3T1x | S | B | I |
| S-1206B45-M3T1x | S | B | J |
| S-1206B46-M3T1x | S | B | K |
| S-1206B47-M3T1x | S | B | L |
| S-1206B48-M3T1x | S | B | M |
| S-1206B49-M3T1x | S | B | N |
| S-1206B50-M3T1x | S | B | O |
| S-1206B51-M3T1x | S | B | P |
| S-1206B52-M3T1x | S | B | Q |

Remark 1. x: G or U

2. Please select products of environmental code = U for Sn 100%, halogen-free products.

2. SOT-89-3

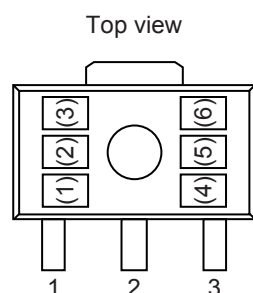

(1) to (3) : Product abbreviation (refer to **Product Name vs. Product Code**)
 (4) to (6) : Lot number

Product Name vs. Product Code

| Product Name | Product Code | | |
|-----------------|--------------|-----|-----|
| | (1) | (2) | (3) |
| S-1206B12-U3T1x | S | A | A |
| S-1206B13-U3T1x | S | A | B |
| S-1206B14-U3T1x | S | A | C |
| S-1206B15-U3T1x | S | A | D |
| S-1206B16-U3T1x | S | A | E |
| S-1206B17-U3T1x | S | A | F |
| S-1206B18-U3T1x | S | A | G |
| S-1206B1J-U3T1x | S | A | H |
| S-1206B19-U3T1x | S | A | I |
| S-1206B20-U3T1x | S | A | J |
| S-1206B21-U3T1x | S | A | K |
| S-1206B22-U3T1x | S | A | L |
| S-1206B23-U3T1x | S | A | M |
| S-1206B24-U3T1x | S | A | N |
| S-1206B25-U3T1x | S | A | O |
| S-1206B26-U3T1x | S | A | P |
| S-1206B27-U3T1x | S | A | Q |
| S-1206B28-U3T1x | S | A | R |
| S-1206B2J-U3T1x | S | A | S |
| S-1206B29-U3T1x | S | A | T |
| S-1206B30-U3T1x | S | A | U |
| S-1206B31-U3T1x | S | A | V |

| Product Name | Product Code | | |
|-----------------|--------------|-----|-----|
| | (1) | (2) | (3) |
| S-1206B32-U3T1x | S | A | W |
| S-1206B33-U3T1x | S | A | X |
| S-1206B34-U3T1x | S | A | Y |
| S-1206B35-U3T1x | S | A | Z |
| S-1206B36-U3T1x | S | B | A |
| S-1206B37-U3T1x | S | B | B |
| S-1206B38-U3T1x | S | B | C |
| S-1206B39-U3T1x | S | B | D |
| S-1206B40-U3T1x | S | B | E |
| S-1206B41-U3T1x | S | B | F |
| S-1206B42-U3T1x | S | B | G |
| S-1206B43-U3T1x | S | B | H |
| S-1206B44-U3T1x | S | B | I |
| S-1206B45-U3T1x | S | B | J |
| S-1206B46-U3T1x | S | B | K |
| S-1206B47-U3T1x | S | B | L |
| S-1206B48-U3T1x | S | B | M |
| S-1206B49-U3T1x | S | B | N |
| S-1206B50-U3T1x | S | B | O |
| S-1206B51-U3T1x | S | B | P |
| S-1206B52-U3T1x | S | B | Q |

Remark 1. x: G or U

2. Please select products of environmental code = U for Sn 100%, halogen-free products.

3. SNT-6A(H)

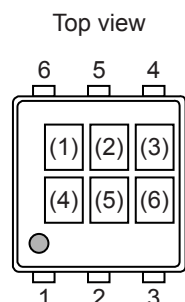

(1) to (3) : Product abbreviation (refer to **Product Name vs. Product Code**)
 (4) to (6) : Lot number

Product Name vs. Product Code

| Product Name | Product Code | | |
|-----------------|--------------|-----|-----|
| | (1) | (2) | (3) |
| S-1206B12-I6T2U | S | A | A |
| S-1206B13-I6T2U | S | A | B |
| S-1206B14-I6T2U | S | A | C |
| S-1206B15-I6T2U | S | A | D |
| S-1206B16-I6T2U | S | A | E |
| S-1206B17-I6T2U | S | A | F |
| S-1206B18-I6T2U | S | A | G |
| S-1206B1J-I6T2U | S | A | H |
| S-1206B19-I6T2U | S | A | I |
| S-1206B20-I6T2U | S | A | J |
| S-1206B21-I6T2U | S | A | K |
| S-1206B22-I6T2U | S | A | L |
| S-1206B23-I6T2U | S | A | M |
| S-1206B24-I6T2U | S | A | N |
| S-1206B25-I6T2U | S | A | O |
| S-1206B26-I6T2U | S | A | P |
| S-1206B27-I6T2U | S | A | Q |
| S-1206B28-I6T2U | S | A | R |
| S-1206B2J-I6T2U | S | A | S |
| S-1206B29-I6T2U | S | A | T |
| S-1206B30-I6T2U | S | A | U |
| S-1206B31-I6T2U | S | A | V |

| Product Name | Product Code | | |
|-----------------|--------------|-----|-----|
| | (1) | (2) | (3) |
| S-1206B32-I6T2U | S | A | W |
| S-1206B33-I6T2U | S | A | X |
| S-1206B34-I6T2U | S | A | Y |
| S-1206B35-I6T2U | S | A | Z |
| S-1206B36-I6T2U | S | B | A |
| S-1206B37-I6T2U | S | B | B |
| S-1206B38-I6T2U | S | B | C |
| S-1206B39-I6T2U | S | B | D |
| S-1206B40-I6T2U | S | B | E |
| S-1206B41-I6T2U | S | B | F |
| S-1206B42-I6T2U | S | B | G |
| S-1206B43-I6T2U | S | B | H |
| S-1206B44-I6T2U | S | B | I |
| S-1206B45-I6T2U | S | B | J |
| S-1206B46-I6T2U | S | B | K |
| S-1206B47-I6T2U | S | B | L |
| S-1206B48-I6T2U | S | B | M |
| S-1206B49-I6T2U | S | B | N |
| S-1206B50-I6T2U | S | B | O |
| S-1206B51-I6T2U | S | B | P |
| S-1206B52-I6T2U | S | B | Q |

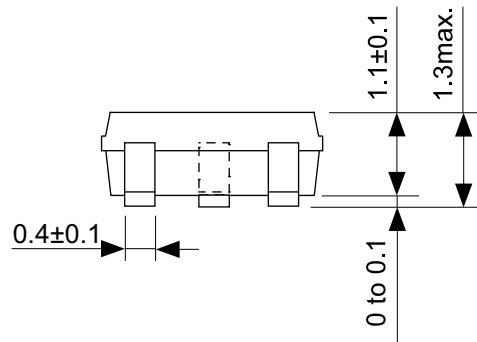
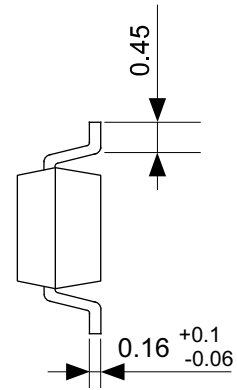
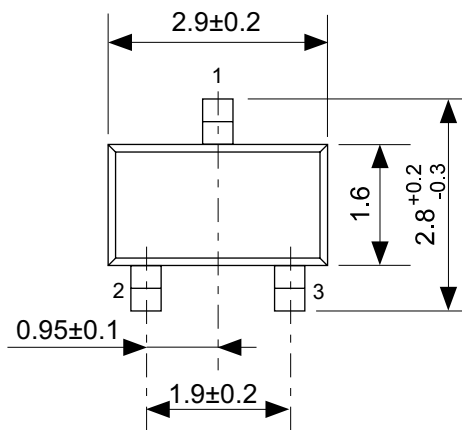

No. MP003-C-P-SD-1.1

| | |
|-------------------|-------------------------|
| TITLE | SOT233-C-PKG Dimensions |
| No. | MP003-C-P-SD-1.1 |
| ANGLE | |
| UNIT | mm |
| | |
| ABLIC Inc. | |

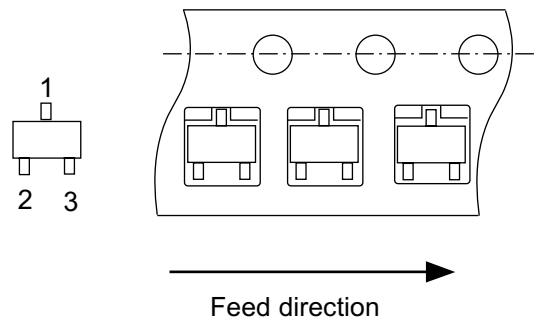
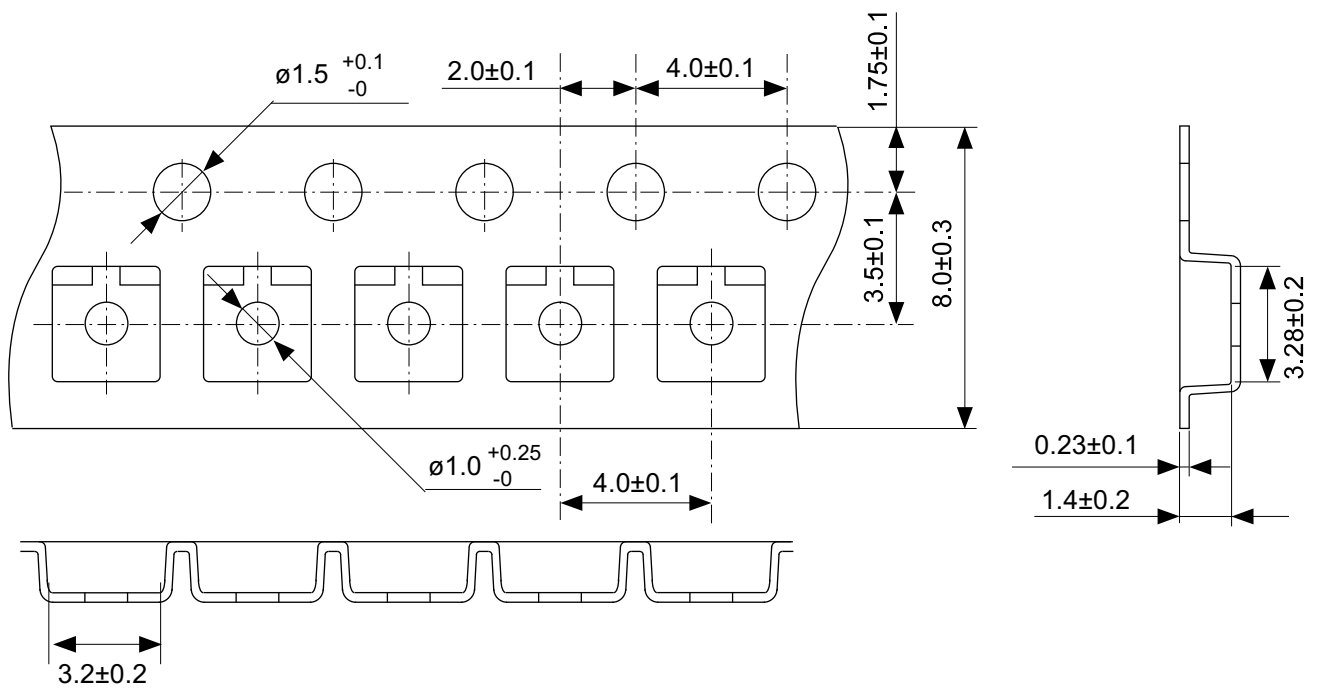

No. MP003-C-C-SD-2.0

| | |
|-------------------|-----------------------|
| TITLE | SOT233-C-Carrier Tape |
| No. | MP003-C-C-SD-2.0 |
| ANGLE | |
| UNIT | mm |
| ABLIC Inc. | |

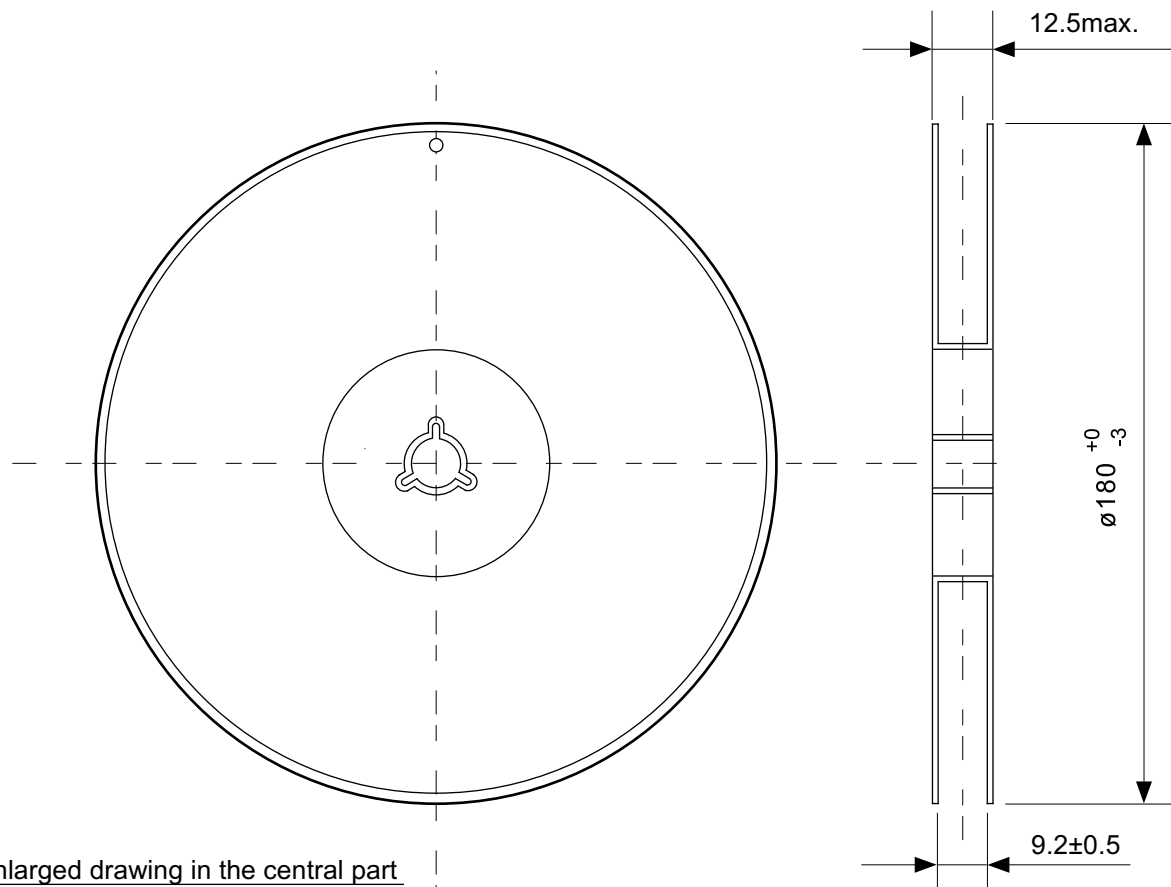

Enlarged drawing in the central part

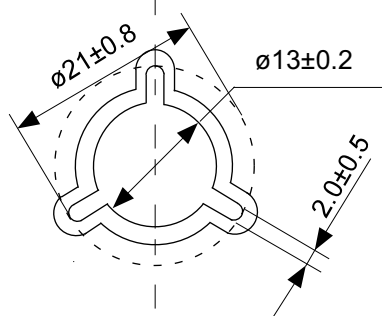

No. MP003-Z-R-SD-1.0

| | | | |
|-------------------|------------------|------|-------|
| TITLE | SOT233-C-Reel | | |
| No. | MP003-Z-R-SD-1.0 | | |
| ANGLE | | QTY. | 3,000 |
| UNIT | mm | | |
| | | | |
| ABLIC Inc. | | | |

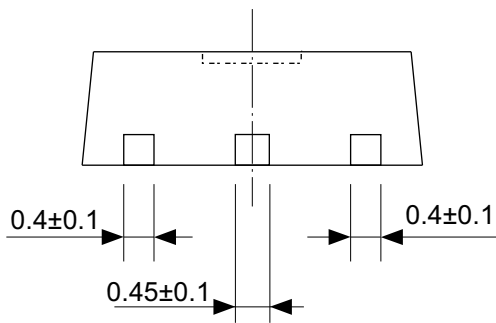
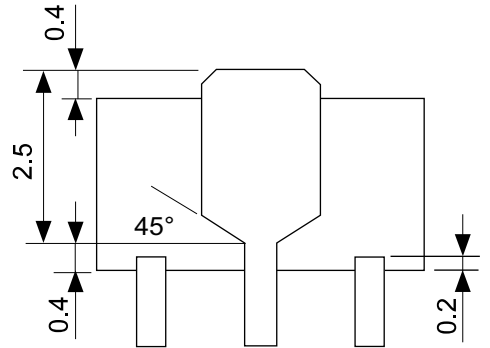
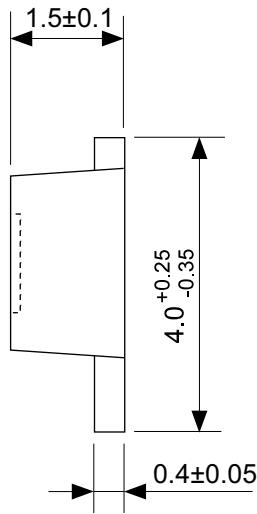
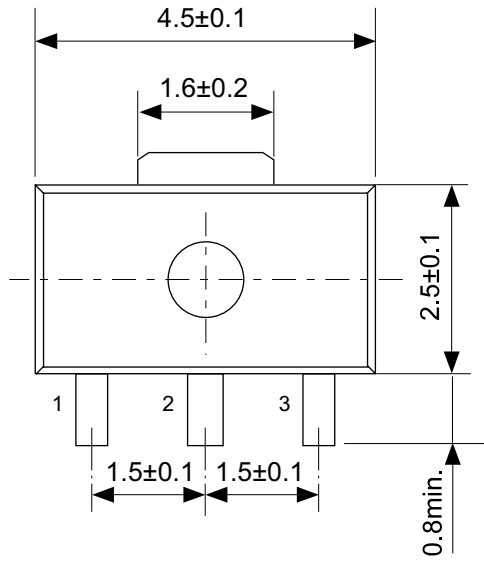

No. UP003-A-P-SD-2.0

| | |
|-------|---|
| TITLE | SOT893-A-PKG Dimensions |
| No. | UP003-A-P-SD-2.0 |
| ANGLE |  |
| UNIT | mm |
| | |

ABLIC Inc.

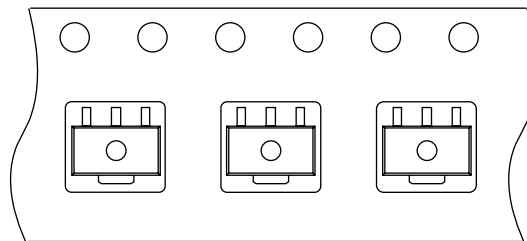
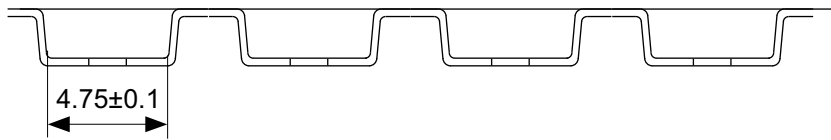
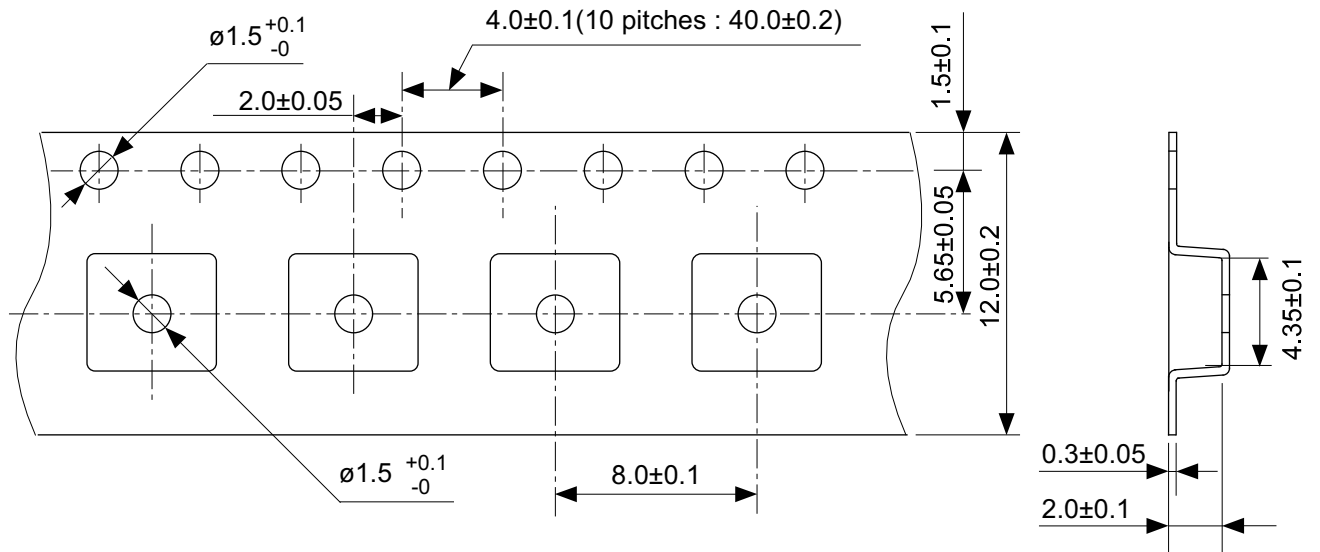

→
Feed direction

No. UP003-A-C-SD-2.0

| | |
|-------------------|-----------------------|
| TITLE | SOT893-A-Carrier Tape |
| No. | UP003-A-C-SD-2.0 |
| ANGLE | |
| UNIT | mm |
| | |
| ABLIC Inc. | |

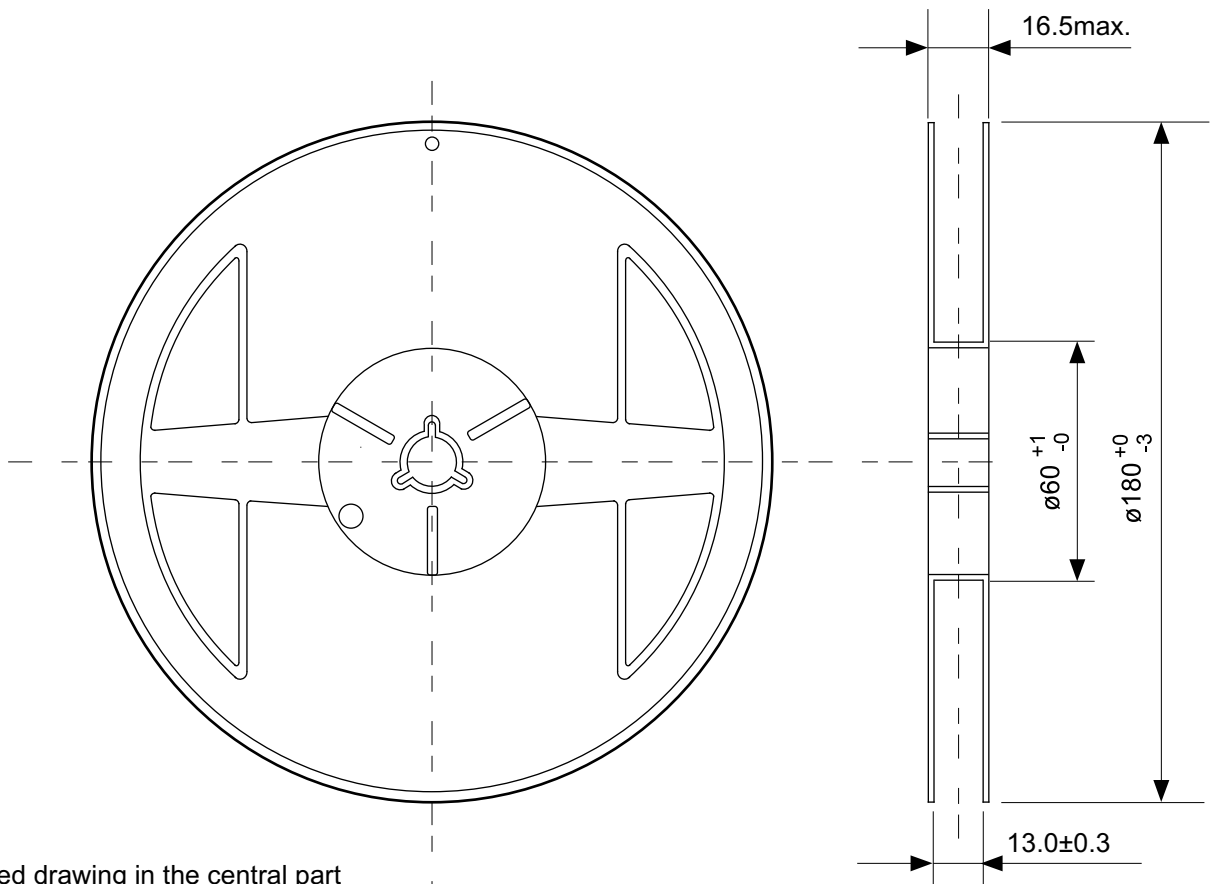

Enlarged drawing in the central part

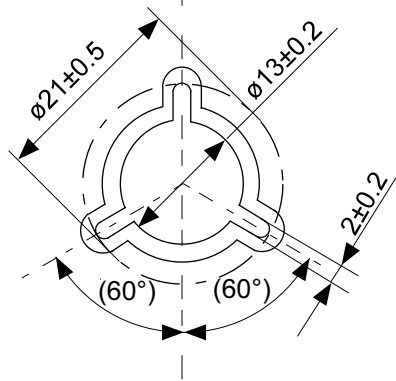

No. UP003-A-R-SD-1.1

| | | | |
|-------------------|------------------|------|-------|
| TITLE | SOT893-A-Reel | | |
| No. | UP003-A-R-SD-1.1 | | |
| ANGLE | | QTY. | 1,000 |
| UNIT | mm | | |
| | | | |
| ABLIC Inc. | | | |

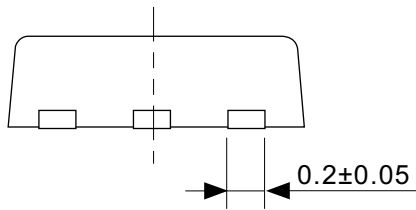

No. PI006-A-P-SD-2.1

| | |
|-------------------|----------------------------|
| TITLE | SNT-6A(H)-A-PKG Dimensions |
| No. | PI006-A-P-SD-2.1 |
| ANGLE | |
| UNIT | mm |
| ABLIC Inc. | |

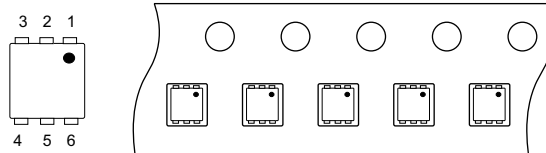

Feed direction →

No. PI006-A-C-SD-2.0

| | |
|-------------------|--------------------------|
| TITLE | SNT-6A(H)-A-Carrier Tape |
| No. | PI006-A-C-SD-2.0 |
| ANGLE | |
| UNIT | mm |
| ABLIC Inc. | |



Enlarged drawing in the central part



No. PI006-A-R-SD-1.0

| | | | |
|-------------------|------------------|------|-------|
| TITLE | SNT-6A(H)-A-Reel | | |
| No. | PI006-A-R-SD-1.0 | | |
| ANGLE | | QTY. | 5,000 |
| UNIT | mm | | |
| | | | |
| ABLIC Inc. | | | |



※1. ランドパターンの幅に注意してください (0.25 mm min. / 0.30 mm typ.).

※2. パッケージ中央にランドパターンを広げないでください (1.30 mm ~ 1.40 mm)。

- 注意
1. パッケージのモールド樹脂下にシルク印刷やハンダ印刷などしないでください。
 2. パッケージ下の配線上のソルダーレジストなどの厚みをランドパターン表面から0.03 mm以下にしてください。
 3. マスク開口サイズと開口位置はランドパターンと合わせてください。
 4. 詳細は "SNTパッケージ活用の手引き" を参照してください。

※1. Pay attention to the land pattern width (0.25 mm min. / 0.30 mm typ.).

※2. Do not widen the land pattern to the center of the package (1.30 mm to 1.40 mm).

- Caution**
1. Do not do silkscreen printing and solder printing under the mold resin of the package.
 2. The thickness of the solder resist on the wire pattern under the package should be 0.03 mm or less from the land pattern surface.
 3. Match the mask aperture size and aperture position with the land pattern.
 4. Refer to "SNT Package User's Guide" for details.

※1. 请注意焊盘模式的宽度 (0.25 mm min. / 0.30 mm typ.).

※2. 请勿向封装中间扩展焊盘模式 (1.30 mm ~ 1.40 mm)。

- 注意
1. 请勿在树脂型封装的下面印刷丝网、焊锡。
 2. 在封装下、布线上的阻焊膜厚度 (从焊盘模式表面起) 请控制在 0.03 mm 以下。
 3. 钢网的开口尺寸和开口位置请与焊盘模式对齐。
 4. 详细内容请参阅 "SNT 封装的应用指南"。

No. PI006-A-L-SD-4.1

| | |
|-------------------|-------------------------------------|
| TITLE | SNT-6A(H)-A -Land Recommendation |
| No. | PI006-A-L-SD-4.1 |
| ANGLE | |
| UNIT | mm |
| ABLIC Inc. | |

Disclaimers (Handling Precautions)

1. All the information described herein (product data, specifications, figures, tables, programs, algorithms and application circuit examples, etc.) is current as of publishing date of this document and is subject to change without notice.
2. The circuit examples and the usages described herein are for reference only, and do not guarantee the success of any specific mass-production design.
ABLIC Inc. is not responsible for damages caused by the reasons other than the products described herein (hereinafter "the products") or infringement of third-party intellectual property right and any other right due to the use of the information described herein.
3. ABLIC Inc. is not responsible for damages caused by the incorrect information described herein.
4. Be careful to use the products within their specified ranges. Pay special attention to the absolute maximum ratings, operation voltage range and electrical characteristics, etc.
ABLIC Inc. is not responsible for damages caused by failures and / or accidents, etc. that occur due to the use of the products outside their specified ranges.
5. When using the products, confirm their applications, and the laws and regulations of the region or country where they are used and verify suitability, safety and other factors for the intended use.
6. When exporting the products, comply with the Foreign Exchange and Foreign Trade Act and all other export-related laws, and follow the required procedures.
7. The products must not be used or provided (exported) for the purposes of the development of weapons of mass destruction or military use. ABLIC Inc. is not responsible for any provision (export) to those whose purpose is to develop, manufacture, use or store nuclear, biological or chemical weapons, missiles, or other military use.
8. The products are not designed to be used as part of any device or equipment that may affect the human body, human life, or assets (such as medical equipment, disaster prevention systems, security systems, combustion control systems, infrastructure control systems, vehicle equipment, traffic systems, in-vehicle equipment, aviation equipment, aerospace equipment, and nuclear-related equipment), excluding when specified for in-vehicle use or other uses. Do not apply the products to the above listed devices and equipments without prior written permission by ABLIC Inc. Especially, the products cannot be used for life support devices, devices implanted in the human body and devices that directly affect human life, etc.
Prior consultation with our sales office is required when considering the above uses.
ABLIC Inc. is not responsible for damages caused by unauthorized or unspecified use of our products.
9. Semiconductor products may fail or malfunction with some probability.
The user of the products should therefore take responsibility to give thorough consideration to safety design including redundancy, fire spread prevention measures, and malfunction prevention to prevent accidents causing injury or death, fires and social damage, etc. that may ensue from the products' failure or malfunction.
The entire system must be sufficiently evaluated and applied on customer's own responsibility.
10. The products are not designed to be radiation-proof. The necessary radiation measures should be taken in the product design by the customer depending on the intended use.
11. The products do not affect human health under normal use. However, they contain chemical substances and heavy metals and should therefore not be put in the mouth. The fracture surfaces of wafers and chips may be sharp. Be careful when handling these with the bare hands to prevent injuries, etc.
12. When disposing of the products, comply with the laws and ordinances of the country or region where they are used.
13. The information described herein contains copyright information and know-how of ABLIC Inc.
The information described herein does not convey any license under any intellectual property rights or any other rights belonging to ABLIC Inc. or a third party. Reproduction or copying of the information from this document or any part of this document described herein for the purpose of disclosing it to a third-party without the express permission of ABLIC Inc. is strictly prohibited.
14. For more details on the information described herein, contact our sales office.

2.2-2018.06

Mouser Electronics

Authorized Distributor

Click to View Pricing, Inventory, Delivery & Lifecycle Information:

ABLIC:

[S-1206B12-I6T2G](#) [S-1206B13-I6T2G](#) [S-1206B14-I6T2G](#) [S-1206B15-I6T2G](#) [S-1206B16-I6T2G](#) [S-1206B17-I6T2G](#)
[S-1206B18-I6T2G](#) [S-1206B19-I6T2G](#) [S-1206B1J-I6T2G](#) [S-1206B20-I6T2G](#) [S-1206B21-I6T2G](#) [S-1206B22-I6T2G](#) [S-](#)
[1206B23-I6T2G](#) [S-1206B24-I6T2G](#) [S-1206B25-I6T2G](#) [S-1206B26-I6T2G](#) [S-1206B27-I6T2G](#) [S-1206B28-I6T2G](#) [S-](#)
[1206B29-I6T2G](#) [S-1206B2J-I6T2G](#) [S-1206B30-I6T2G](#) [S-1206B31-I6T2G](#) [S-1206B32-I6T2G](#) [S-1206B33-I6T2G](#) [S-](#)
[1206B34-I6T2G](#) [S-1206B35-I6T2G](#) [S-1206B36-I6T2G](#) [S-1206B37-I6T2G](#) [S-1206B38-I6T2G](#) [S-1206B39-I6T2G](#) [S-](#)
[1206B40-I6T2G](#) [S-1206B41-I6T2G](#) [S-1206B42-I6T2G](#) [S-1206B43-I6T2G](#) [S-1206B44-I6T2G](#) [S-1206B45-I6T2G](#) [S-](#)
[1206B46-I6T2G](#) [S-1206B47-I6T2G](#) [S-1206B48-I6T2G](#) [S-1206B49-I6T2G](#) [S-1206B50-I6T2G](#) [S-1206B51-I6T2G](#) [S-](#)
[1206B52-I6T2G](#) [S-812C34AY-B2-U](#) [S-812C35AY-B2-U](#) [S-812C36AY-B2-U](#) [S-817B11AY-B2-U](#) [S-817B12AY-B2-U](#)
[S-817B13AY-B2-U](#) [S-817B14AY-B2-U](#) [S-817B15AY-B2-U](#) [S-817B16AY-B2-U](#) [S-812C21AY-B2-U](#) [S-812C22AY-B2-U](#)
[S-812C23AY-B2-U](#) [S-812C24AY-B2-U](#) [S-812C25AY-B2-U](#) [S-812C26AY-B2-U](#) [S-812C27AY-B2-U](#) [S-812C29AY-B2-](#)
[U](#) [S-812C32AY-B2-U](#) [S-812C33AY-B2-U](#) [S-812C37AY-B2-U](#) [S-812C38AY-B2-U](#) [S-812C39AY-B2-U](#) [S-812C40AY-](#)
[B2-U](#) [S-812C41AY-B2-U](#) [S-812C42AY-B2-U](#) [S-812C43AY-B2-U](#) [S-812C44AY-B2-U](#) [S-812C45AY-B2-U](#) [S-](#)
[812C46AY-B2-U](#) [S-812C47AY-B2-U](#) [S-812C48AY-B2-U](#) [S-812C49AY-B2-U](#) [S-812C51AY-B2-U](#) [S-812C52AY-B2-U](#)
[S-812C53AY-B2-U](#) [S-812C54AY-B2-U](#) [S-812C55AY-B2-U](#) [S-812C56AY-B2-U](#) [S-812C57AY-B2-U](#) [S-812C58AY-B2-](#)
[U](#) [S-812C59AY-B2-U](#) [S-812C60AY-B2-U](#) [S-817B17AY-B2-U](#) [S-817B18AY-B2-U](#) [S-817B19AY-B2-U](#) [S-817B20AY-](#)
[B2-U](#) [S-817B21AY-B2-U](#) [S-817B22AY-B2-U](#) [S-817B23AY-B2-U](#) [S-817B24AY-B2-U](#) [S-817B25AY-B2-U](#) [S-](#)
[817B27AY-B2-U](#) [S-817B28AY-B2-U](#) [S-817B29AY-B2-U](#) [S-817B30AY-B2-U](#) [S-817B31AY-B2-U](#) [S-817B32AY-B2-U](#)