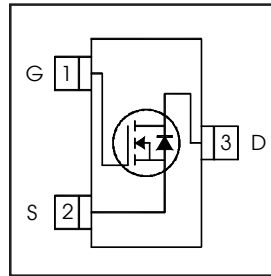


# IRLML6246TRPbF

HEXFET® Power MOSFET

$V_{DS}$	<b>20</b>	<b>V</b>
$V_{GS\ Max}$	<b>± 12</b>	<b>V</b>
$R_{DS(on)\ max}$ (@ $V_{GS} = 4.5V$ )	<b>46</b>	<b>mΩ</b>
$R_{DS(on)\ max}$ (@ $V_{GS} = 2.5V$ )	<b>66</b>	<b>mΩ</b>



## Application(s)

- Load/ System Switch

## Features and Benefits

### Features

Industry-standard SOT-23 Package
RoHS compliant containing no lead, no bromide and no halogen

results in

### Benefits

Multi-vendor compatibility
Environmentally friendly

## Absolute Maximum Ratings

Symbol	Parameter	Max.	Units
$V_{DS}$	Drain-Source Voltage	20	V
$I_D @ T_A = 25^\circ C$	Continuous Drain Current, $V_{GS} @ 10V$	4.1	A
$I_D @ T_A = 70^\circ C$	Continuous Drain Current, $V_{GS} @ 10V$	3.3	
$I_{DM}$	Pulsed Drain Current	16	
$P_D @ T_A = 25^\circ C$	Maximum Power Dissipation	1.3	W
$P_D @ T_A = 70^\circ C$	Maximum Power Dissipation	0.8	
	Linear Derating Factor	0.01	W/°C
$V_{GS}$	Gate-to-Source Voltage	± 12	V
$T_J, T_{STG}$	Junction and Storage Temperature Range	-55 to + 150	°C

## Thermal Resistance

Symbol	Parameter	Typ.	Max.	Units
$R_{\theta JA}$	Junction-to-Ambient ③	—	100	°C/W
$R_{\theta JA}$	Junction-to-Ambient (t<10s) ④	—	99	

### ORDERING INFORMATION:

See detailed ordering and shipping information on the last page of this data sheet.

Notes ① through ④ are on page 10


www.irf.com

# IRLML6246TRPbF

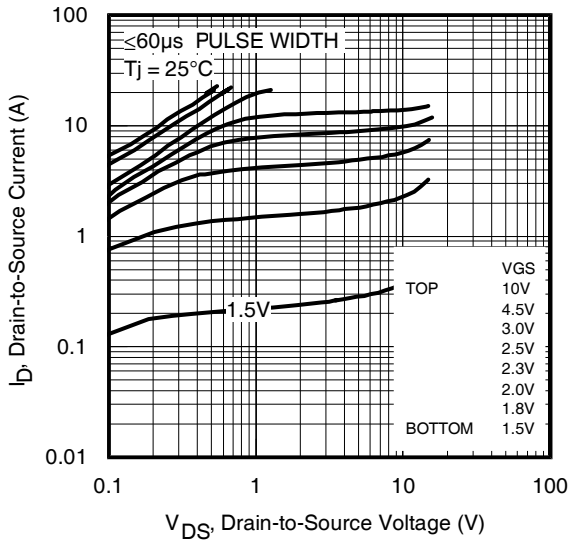
## Electric Characteristics @ $T_J = 25^\circ\text{C}$ (unless otherwise specified)

Symbol	Parameter	Min.	Typ.	Max.	Units	Conditions
$V_{(BR)DSS}$	Drain-to-Source Breakdown Voltage	20	—	—	V	$V_{GS} = 0V, I_D = 250\mu A$
$\Delta V_{(BR)DSS}/\Delta T_J$	Breakdown Voltage Temp. Coefficient	—	0.03	—	V/ $^\circ\text{C}$	Reference to $25^\circ\text{C}, I_D = 1\text{mA}$
$R_{DS(on)}$	Static Drain-to-Source On-Resistance	—	30	46	m $\Omega$	$V_{GS} = 4.5V, I_D = 4.1A$ ②
		—	45	66		$V_{GS} = 2.5V, I_D = 3.3A$ ②
$V_{GS(th)}$	Gate Threshold Voltage	0.5	0.8	1.1	V	$V_{DS} = V_{GS}, I_D = 5\mu A$
$I_{DSS}$	Drain-to-Source Leakage Current	—	—	1.0	$\mu A$	$V_{DS} = 16V, V_{GS} = 0V$
		—	—	10		$V_{DS} = 16V, V_{GS} = 0V, T_J = 55^\circ\text{C}$
		—	—	150		$V_{DS} = 16V, V_{GS} = 0V, T_J = 125^\circ\text{C}$
$I_{GSS}$	Gate-to-Source Forward Leakage	—	—	100	nA	$V_{GS} = 12V$
	Gate-to-Source Reverse Leakage	—	—	-100		$V_{GS} = -12V$
$R_G$	Internal Gate Resistance	—	4.0	—	$\Omega$	
$g_{fs}$	Forward Transconductance	10	—	—	S	$V_{DS} = 10V, I_D = 4.1A$
$Q_g$	Total Gate Charge	—	3.5	—	nC	$I_D = 4.1A$
$Q_{gs}$	Gate-to-Source Charge	—	0.26	—		$V_{DS} = 10V$
$Q_{gd}$	Gate-to-Drain ("Miller") Charge	—	1.7	—		$V_{GS} = 4.5V$ ②
$t_{d(on)}$	Turn-On Delay Time	—	3.6	—	ns	$V_{DD} = 10V$ ②
$t_r$	Rise Time	—	4.9	—		$I_D = 1.0A$
$t_{d(off)}$	Turn-Off Delay Time	—	11	—		$R_G = 6.8\Omega$
$t_f$	Fall Time	—	6.0	—		$V_{GS} = 4.5V$
$C_{iss}$	Input Capacitance	—	290	—	pF	$V_{GS} = 0V$
$C_{oss}$	Output Capacitance	—	64	—		$V_{DS} = 16V$
$C_{rss}$	Reverse Transfer Capacitance	—	41	—		$f = 1.0\text{MHz}$

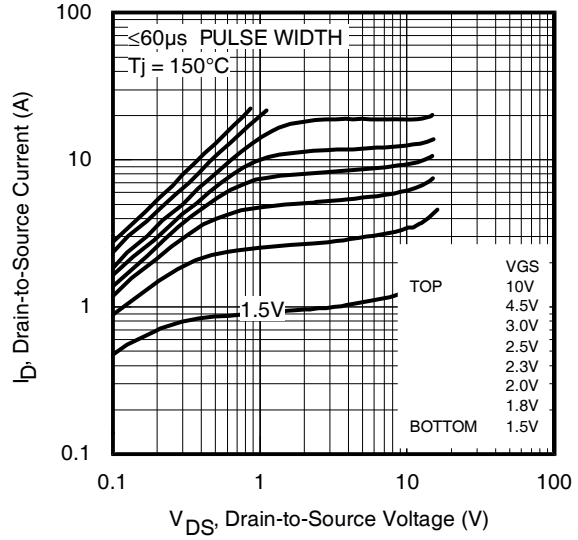
## Source - Drain Ratings and Characteristics

Symbol	Parameter	Min.	Typ.	Max.	Units	Conditions
$I_S$	Continuous Source Current (Body Diode)	—	—	1.3	A	MOSFET symbol showing the integral reverse p-n junction diode. 
$I_{SM}$	Pulsed Source Current (Body Diode) ①	—	—	16		
$V_{SD}$	Diode Forward Voltage	—	—	1.2	V	$T_J = 25^\circ\text{C}, I_S = 4.1A, V_{GS} = 0V$ ②
$t_{rr}$	Reverse Recovery Time	—	8.6	13	ns	$T_J = 25^\circ\text{C}, V_R = 15V, I_F = 1.3A$
$Q_{rr}$	Reverse Recovery Charge	—	2.8	4.2	nC	$di/dt = 100A/\mu s$ ②

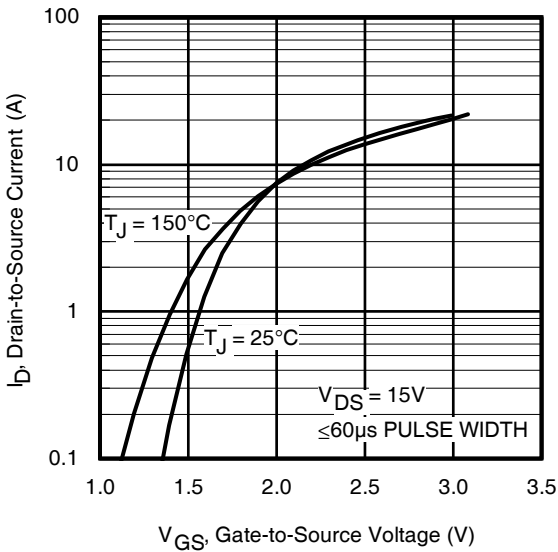
# IRLML6246TRPbF



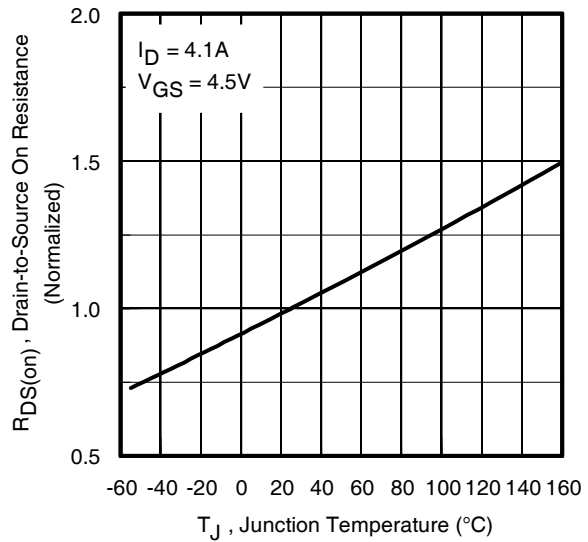
**Fig 1.** Typical Output Characteristics



**Fig 2.** Typical Output Characteristics

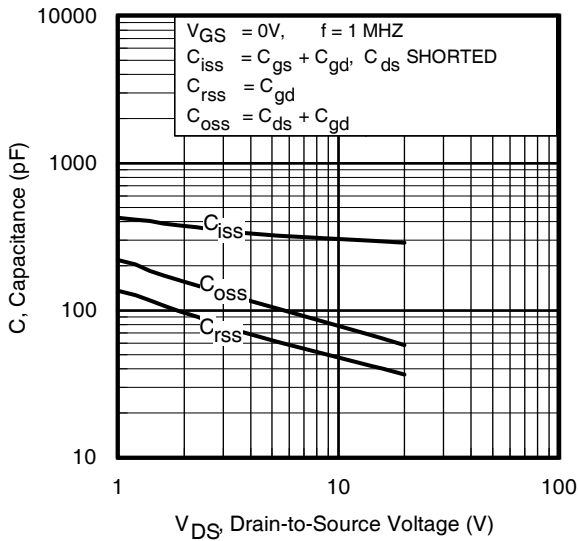


**Fig 3.** Typical Transfer Characteristics

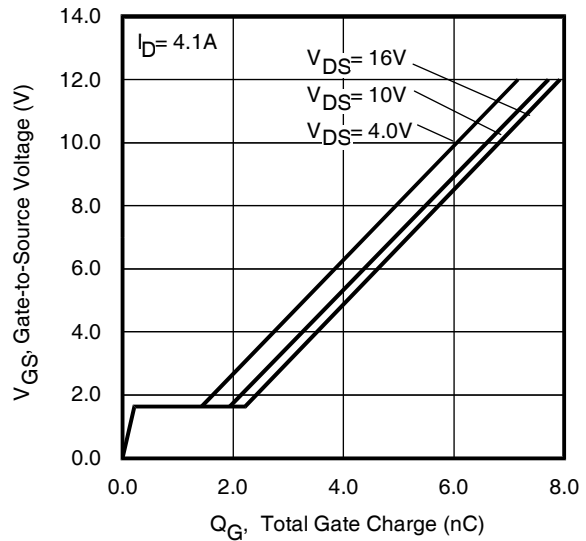


**Fig 4.** Normalized On-Resistance Vs. Temperature

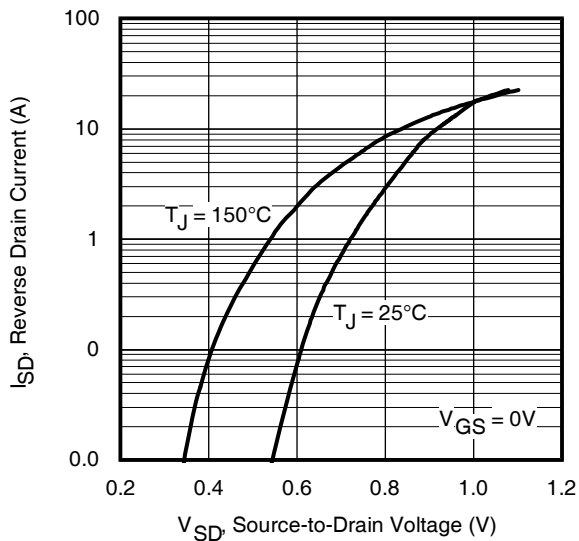
# IRLML6246TRPbF



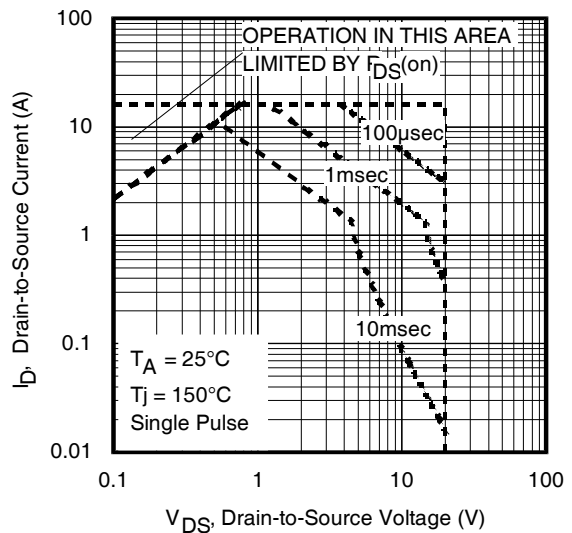
**Fig 5.** Typical Capacitance Vs. Drain-to-Source Voltage



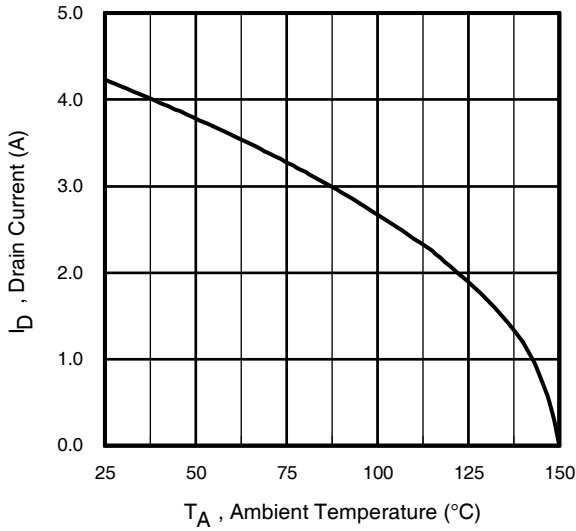
**Fig 6.** Typical Gate Charge Vs. Gate-to-Source Voltage



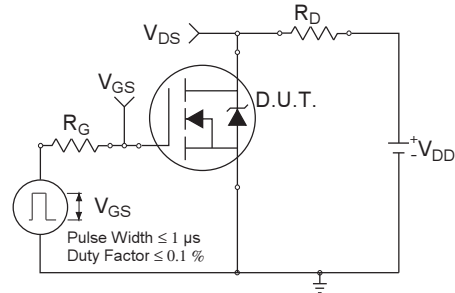
**Fig 7.** Typical Source-Drain Diode Forward Voltage



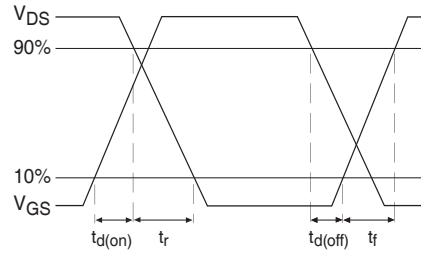
**Fig 8.** Maximum Safe Operating Area



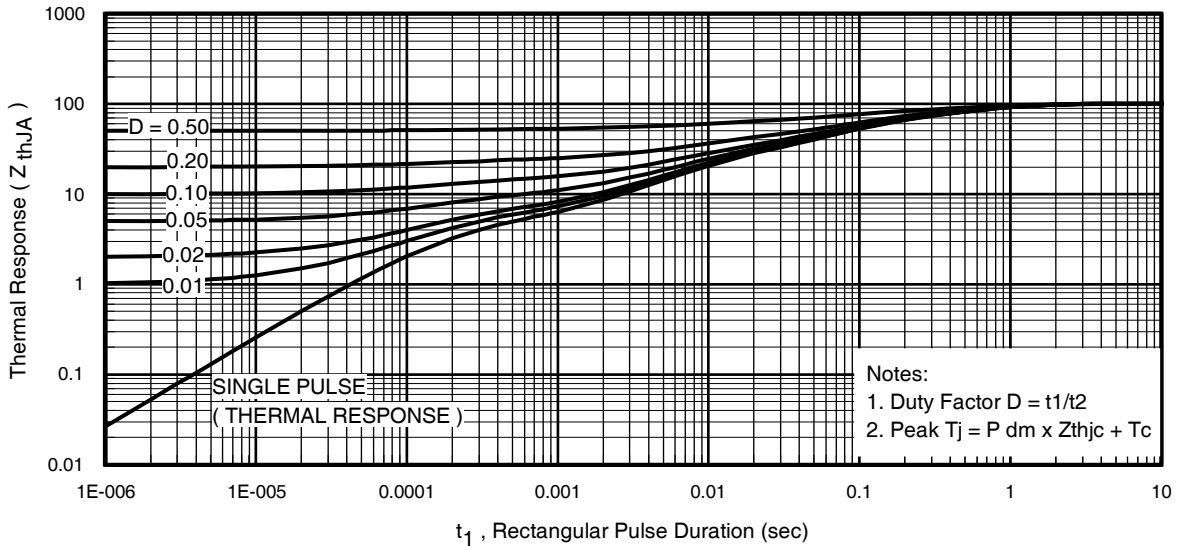
**Fig 9.** Maximum Drain Current Vs. Ambient Temperature



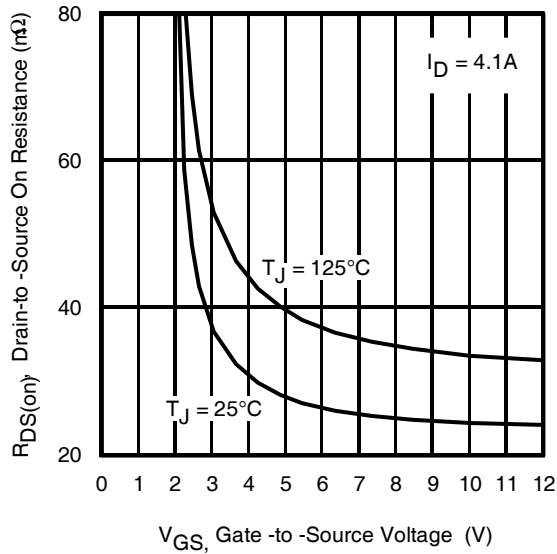
**Fig 10a.** Switching Time Test Circuit



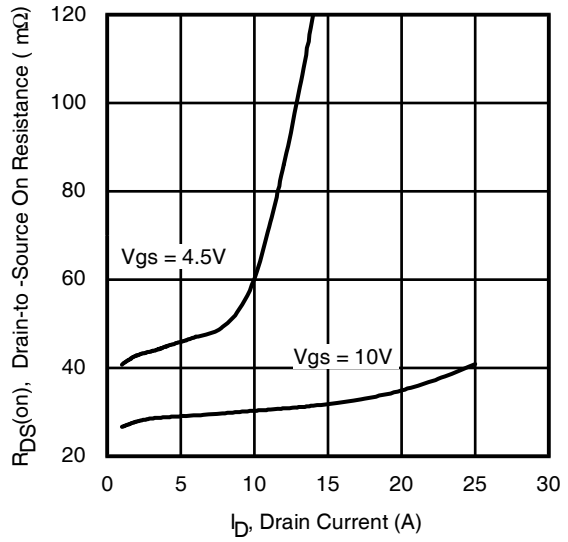
**Fig 10b.** Switching Time Waveforms



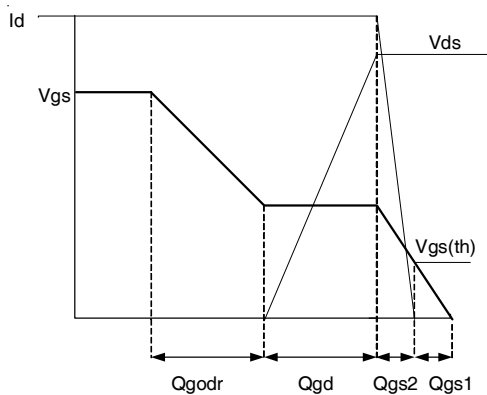
**Fig 11.** Typical Effective Transient Thermal Impedance, Junction-to-Ambient



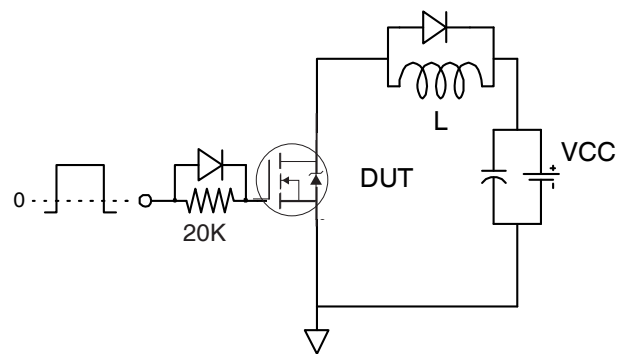
**Fig 12.** Typical On-Resistance Vs. Gate Voltage



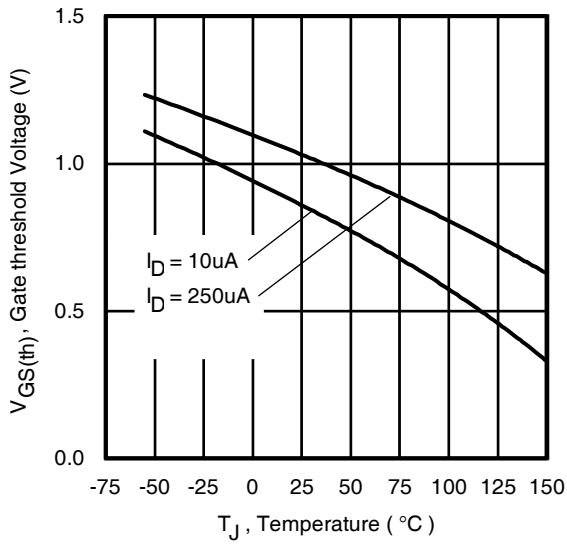
**Fig 13.** Typical On-Resistance Vs. Drain Current



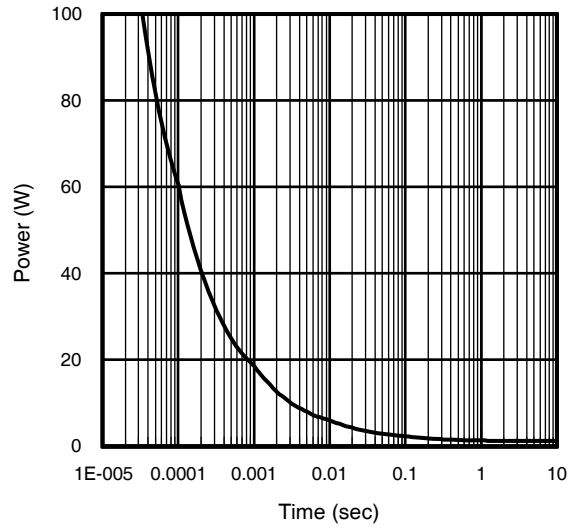
**Fig 14a.** Basic Gate Charge Waveform



**Fig 14b.** Gate Charge Test Circuit



**Fig 15.** Typical Threshold Voltage Vs. Junction Temperature



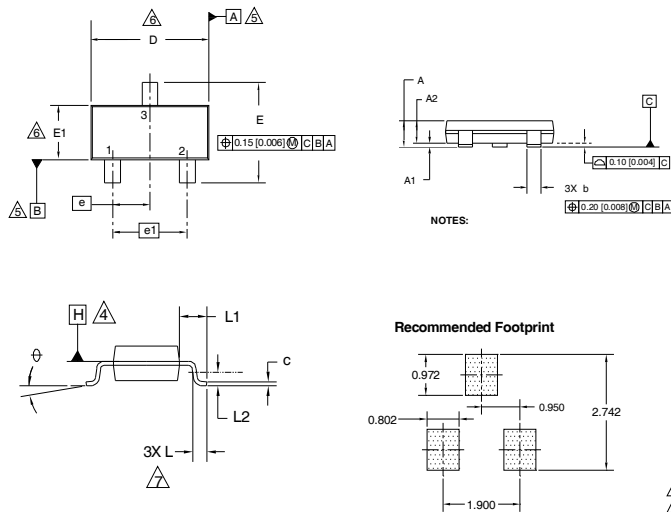
**Fig 16.** Typical Power Vs. Time

# IRLML6246TRPbF



## Micro3™(SOT-23) Package Outline

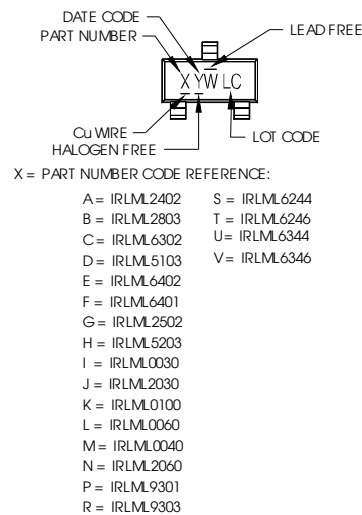
Dimensions are shown in millimeters (inches)



DIMENSIONS				
SYMBOL	MILLIMETERS		INCHES	
	MIN	MAX	MIN	MAX
A	0.89	1.12	0.035	0.044
A1	0.01	0.10	0.0004	0.004
A2	0.88	1.02	0.035	0.040
b	0.30	0.50	0.012	0.020
c	0.08	0.20	0.003	0.008
D	2.80	3.04	0.110	0.120
E	2.10	2.64	0.083	0.104
E1	1.20	1.40	0.047	0.055
e	0.95	BSC	0.037	BSC
e1	1.90	BSC	0.075	BSC
L	0.40	0.60	0.016	0.024
L1	0.54	REF	0.021	REF
L2	0.25	BSC	0.010	BSC
⌀	0	8	0	8

1. DIMENSIONING & TOLERANCING PER ANSI Y14.5M-1994
2. DIMENSIONS ARE SHOWN IN MILLIMETERS (INCHES)
3. CONTROLLING DIMENSION: MILLIMETER
4. DATUM PLANE H IS LOCATED AT THE MOLD PARTING LINE
5. DATUM A AND B TO BE DETERMINED AT DATUM PLANE H
6. DIMENSIONS D AND E1 ARE MEASURED AT DATUM PLANE H. DIMENSIONS DOES NOT INCLUDE MOLD PROTRUSIONS OR INTERLEAD FLASH. MOLD PROTRUSIONS OR INTERLEAD FLASH SHALL NOT EXCEED 0.25 MM (0.010 INCH) PER SIDE.
7. DIMENSION L IS THE LEAD LENGTH FOR SOLDERING TO A SUBSTRATE.
8. OUTLINE CONFORMS TO JEDEC OUTLINE TO-236 AB.

## Micro3™(SOT-23) Part Marking Information



Note: A line above the work week (as shown here) indicates Lead-Free.

W = (1-26) IF PRECEDED BY LAST DIGIT OF CALENDAR YEAR

YEAR	Y	WORK WEEK	W
2001	1	01	A
2002	2	02	B
2003	3	03	C
2004	4	04	D
2005	5		
2006	6		
2007	7		
2008	8		
2009	9		
2010	0	24	X
		25	Y
		26	Z

W = (27-52) IF PRECEDED BY A LETTER

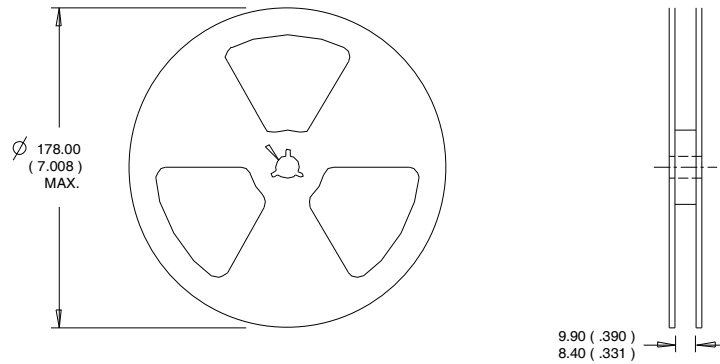
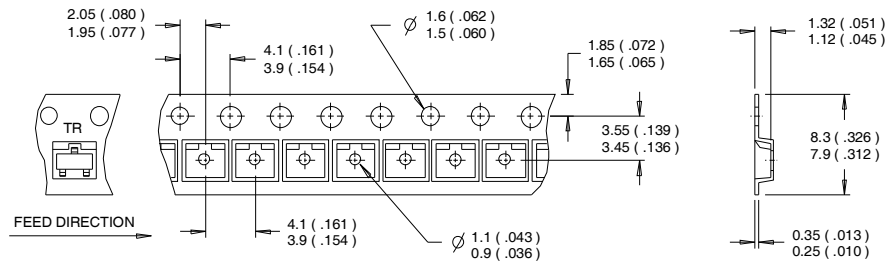
YEAR	Y	WORK WEEK	W
2001	A	27	A
2002	B	28	B
2003	C	29	C
2004	D	30	D
2005	E		
2006	F		
2007	G		
2008	H		
2009	J		
2010	K	50	X
		51	Y
		52	Z

Note: For the most current drawing please refer to IR website at: <http://www.irf.com/package/>



## Micro3™(SOT-23) Tape & Reel Information

Dimensions are shown in millimeters (inches)



- NOTES:  
 1. CONTROLLING DIMENSION : MILLIMETER.  
 2. OUTLINE CONFORMS TO EIA-481 & EIA-541.

Note: For the most current drawing please refer to IR website at: <http://www.irf.com/package/>

# IRLML6246TRPbF

International  
 Rectifier

Orderable part number	Package Type	Standard Pack		Note
		Form	Quantity	
IRLML6246TRPbF	Micro3™(SOT-23)	Tape and Reel	3000	

## Qualification information<sup>†</sup>

Qualification level	Consumer <sup>††</sup> (per JEDEC JESD47F <sup>†††</sup> guidelines)		
Moisture Sensitivity Level	Micro3™(SOT-23)	MSL1 (per IPC/JEDEC J-STD-020D <sup>†††</sup> )	
RoHS compliant	Yes		

† Qualification standards can be found at International Rectifier's web site  
<http://www.irf.com/product-info/reliability>

†† Higher qualification ratings may be available should the user have such requirements.  
 Please contact your International Rectifier sales representative for further information:  
<http://www.irf.com/whoto-call/salesrep/>

††† Applicable version of JEDEC standard at the time of product release.

## Notes:

- ① Repetitive rating; pulse width limited by max. junction temperature.
- ② Pulse width ≤ 400µs; duty cycle ≤ 2%.
- ③ Surface mounted on 1 in square Cu board
- ④ Refer to [application note #AN-994](#).

## Revision History

Date	Comments
10/12/2012	Added IDSS @ 16V, T <sub>J</sub> = 55C-pg2

Data and specifications subject to change without notice.

International  
 Rectifier

IR WORLD HEADQUARTERS: 101N. Sepulveda blvd, El Segundo, California 90245, USA Tel: (310) 252-7105  
 TAC Fax: (310) 252-7903

Visit us at [www.irf.com](http://www.irf.com) for sales contact information.10/2012

# Mouser Electronics

Authorized Distributor

Click to View Pricing, Inventory, Delivery & Lifecycle Information:

[Infineon:](#)

[IRLML6246TRPBF](#)