

Q6012LTH1LED Series

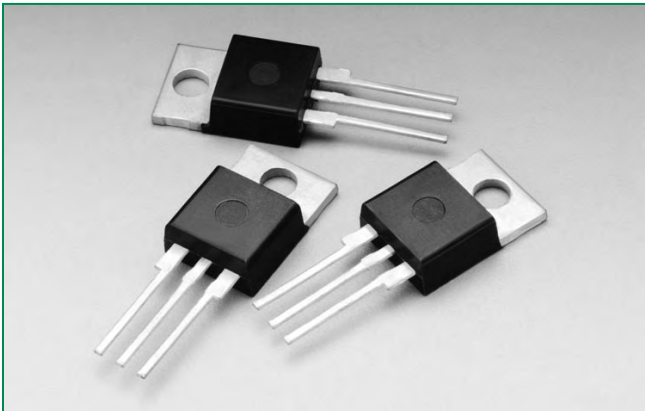

Agency Approval

Agency	Agency File Number
	L Package : E71639

Main Features

Symbol	Value	Unit
$I_{T(RMS)}$	12	A
V_{DRM}/V_{RRM}	600	V
DIAC V_{BO}	33 to 43	V

Schematic Symbol

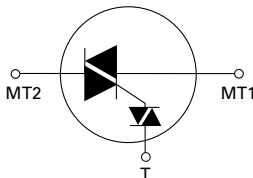

Additional Information



Datasheet



Resources



Samples

Description

The Quadrac is an internally triggered Triac designed for AC switching and phase control applications. It is a Triac and DIAC in a single package, which saves user expense by eliminating the need for separate Triac and DIAC components.

Q6012LTH1LED series is designed to meet low load current characteristics typical in LED lighting applications.

By keeping holding current at 8mA maximum, this Quadrac series is characterized and specified to perform best with LED loads. The Q6012LTH1LED series is best suited for LED dimming controls to obtain the lowest levels of light output with a minimum probability of flickering.

Q6012LTH1LED series is offered in the industry standard TO-220AB package with an isolated mounting tab that makes it best suited for adding an external heat sink.

Features

- As low as 8mA max holding current
- UL Recognized TO-220AB package
- 110°C rated junction temperature
- di/dt performance of 70A/μs
- QUADRAC version includes intergrated DIAC

Benefits

- Provides full control of light out put at the extreme low end of load conditions.
- 2500V_{AC} min isolation between mounting tab and active terminals
- Improves margin of safe operation with less heat sinking required
- Enable survivability of typically LED load operating characteristics
- Simplicity of circuit design & layout

Applications

Excellent for AC switching and phase control applications such as lighting and motor speed controls. Typical applications are AC solid-state switches, light dimmers with LED loads, small low current motor in power tools, and low current motors in home/brown goods appliances.

Internally constructed isolated package is offered for ease of heat sinking with highest isolation voltage.

Absolute Maximum Ratings

Symbol	Parameter		Value	Unit
$I_{T(RMS)}$	RMS forward current	$T_c = 90^\circ\text{C}$	12	A
I_{TSM}	Peak non-repetitive surge current	single half cycle; $f = 50\text{Hz}$; T_J (initial) = 25°C	110	A
		single half cycle; $f = 60\text{Hz}$; T_J (initial) = 25°C	120	
I^2t	I^2t value for fusing	$t_p = 8.3\text{ms}$	60	A^2s
di/dt	Critical rate-of-rise of on-state current	$f = 60\text{Hz}$; $T_J = 110^\circ\text{C}$	70	$\text{A}/\mu\text{s}$
I_{GM}	Peak gate current	$T_J = 110^\circ\text{C}$	1.5	A
T_{stg}	Storage temperature range		-40 to 150	$^\circ\text{C}$
T_J	Operating junction temperature range		-40 to 110	$^\circ\text{C}$

Electrical Characteristics ($T_J = 25^\circ\text{C}$, unless otherwise specified) – Alternistor Quadrac

Symbol	Test Conditions		Value	Unit
I_H	$I_T = 20\text{mA}$ (initial)	MAX.	8	mA
dv/dt	$V_D = V_{DRM}$; gate open; $T_J = 110^\circ\text{C}$	MIN.	45	$\text{V}/\mu\text{s}$
$dv/dt(c)$	$di/dt(c) = 0.54 \times I_{T(rms)} / \text{ms}$; $T_J = 110^\circ\text{C}$	MIN.	2	$\text{V}/\mu\text{s}$
t_{gt}	(note 1)	TYP.	3	μs

(1) Reference test circuit in figure 7 and waveform in figure 8; $C_T = 0.1\mu\text{F}$ with $0.1\mu\text{s}$ rise time.

Trigger DIAC Specifications

Symbol	Test Conditions		Value	Unit
ΔV_{BO}	Breakover Voltage Symmetry	MAX.	3	V
V_{BO}	Breakover Voltage, forward and reverse	MIN.	33	V
		MAX.	43	
$[\Delta V_{\pm}]$	Dynamic Breakback Voltage, forward and reverse (note 1)	MIN.	5	V
I_{BO}	Peak Breakover Current	MAX.	25	μA
C_T	Trigger Firing Capacitance	MAX.	0.1	μF

(1) Reference test circuit in figure 7 and waveform in figure 8.

Static Characteristics

Symbol	Test Conditions			Value	Unit
V_{TM}	$I_T = 1.41 \times I_{T(rms)}$ A; $t_p = 380\mu\text{s}$		MAX.	1.6	V
I_{DRM} / I_{RRM}	V_{DRM} / V_{RRM}	$T_J = 25^\circ\text{C}$	MAX.	10	μA
		$T_J = 110^\circ\text{C}$		1000	

Thermal Resistances

Symbol	Parameter	Value	Unit
$R_{\theta(J-C)}$	Junction to case (AC)	2.3	$^\circ\text{C}/\text{W}$
$R_{\theta(J-A)}$	Junction to ambient	50	$^\circ\text{C}/\text{W}$

Figure 1: Normalized DC Holding Current vs. Junction Temperature

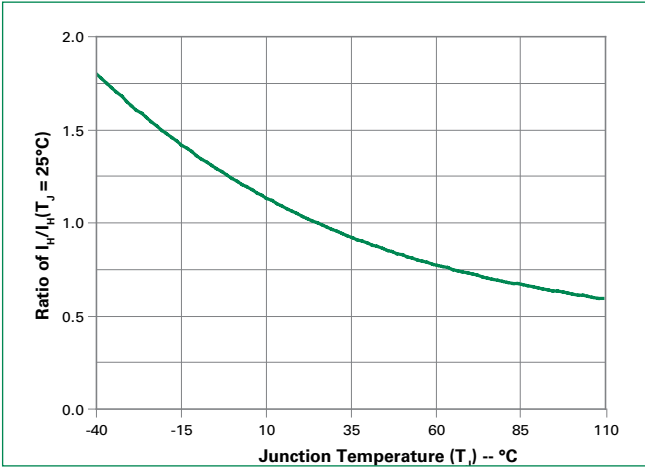

Figure 2: On-State Current vs. On-State Voltage (Typical)

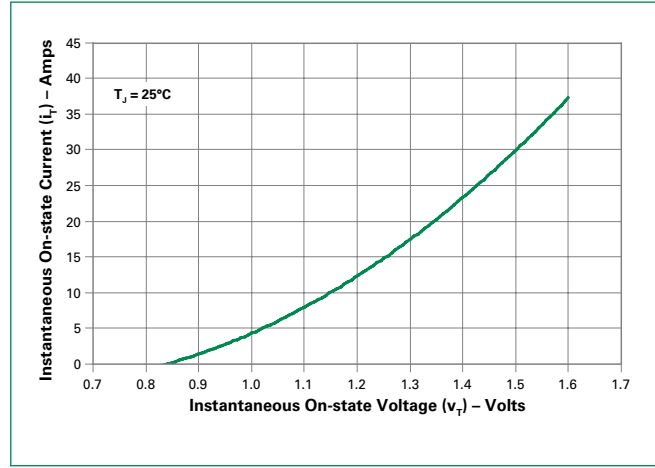

Figure 3: Power Dissipation vs. RMS On-State Current (Typical)

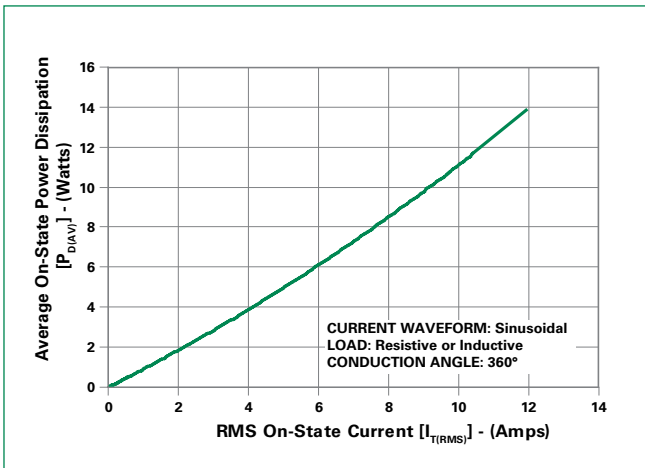

Figure 4: Maximum Allowable Case Temperature vs. RMS On-State Current

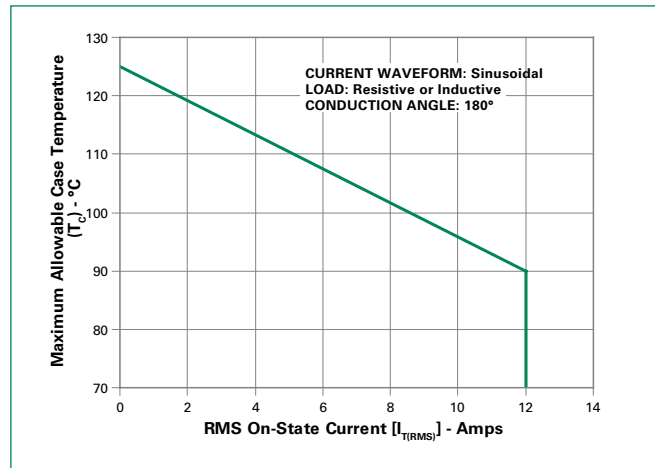
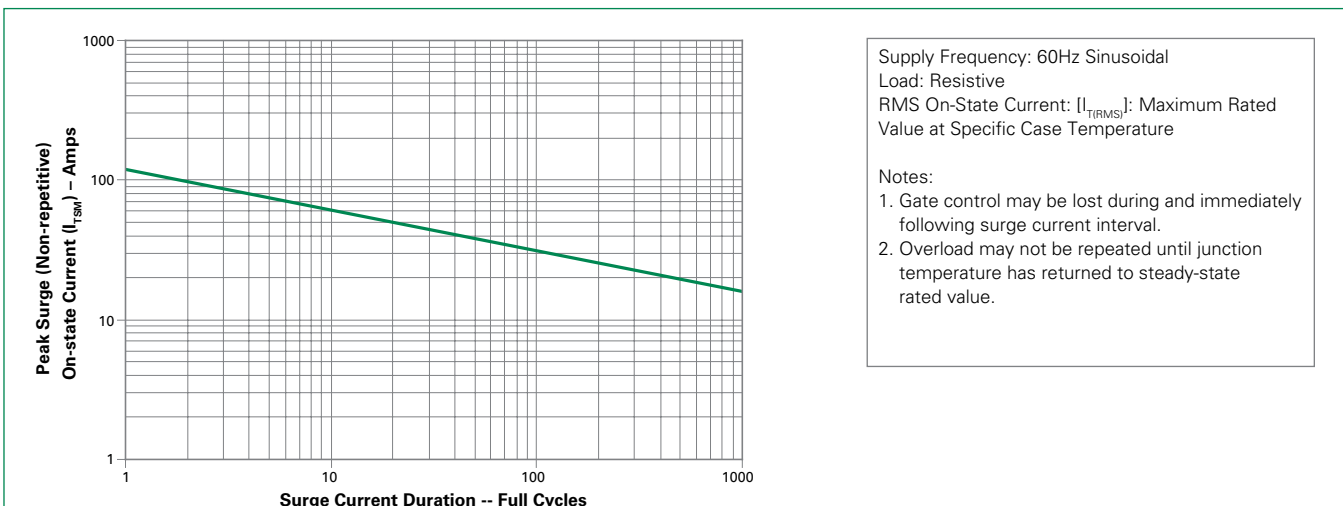

Figure 5: Surge Peak On-State Current vs. Number of Cycles



Supply Frequency: 60Hz Sinusoidal
Load: Resistive
RMS On-State Current: [I_{T(RMS)}]: Maximum Rated Value at Specific Case Temperature

Notes:
1. Gate control may be lost during and immediately following surge current interval.
2. Overload may not be repeated until junction temperature has returned to steady-state rated value.

Figure 6: DIAC V_{BO} Change vs. Junction Temperature

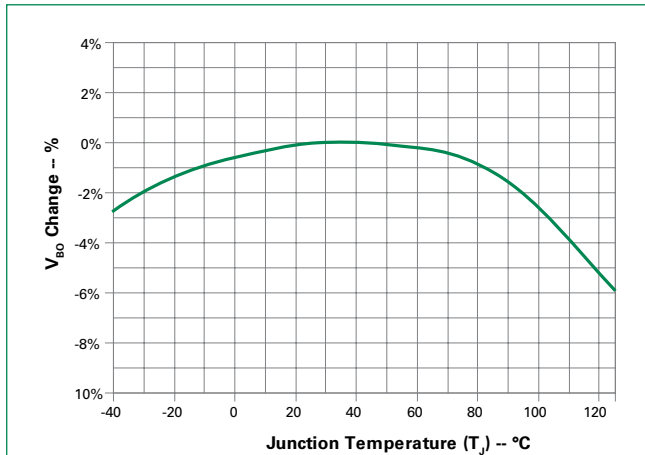

Figure 7: Test Circuit

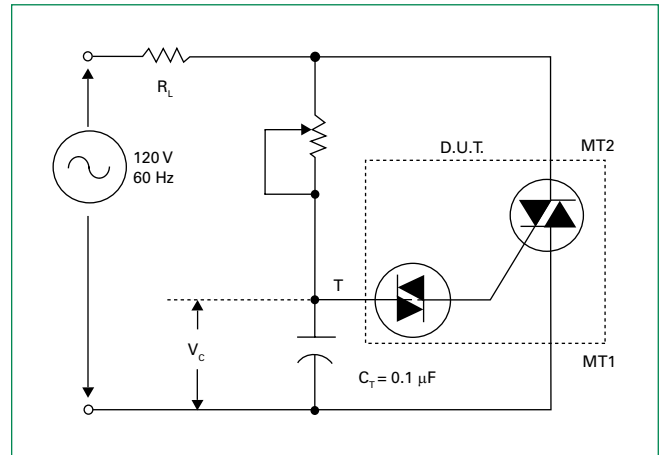

Figure 8: Test Circuit Waveform

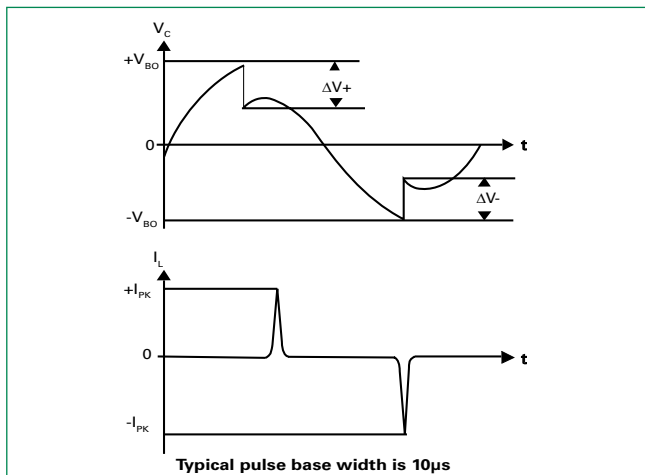
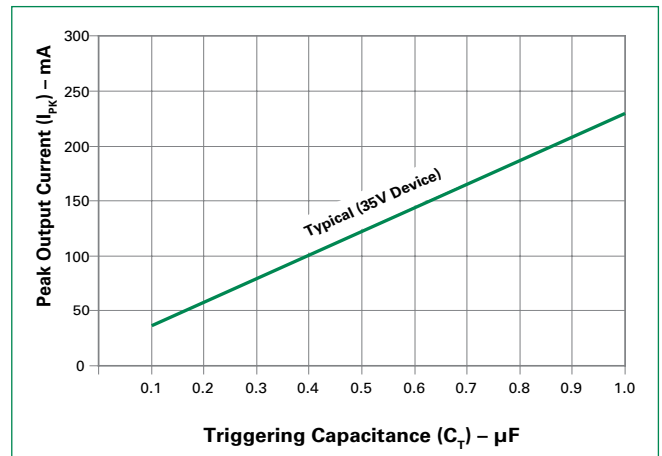
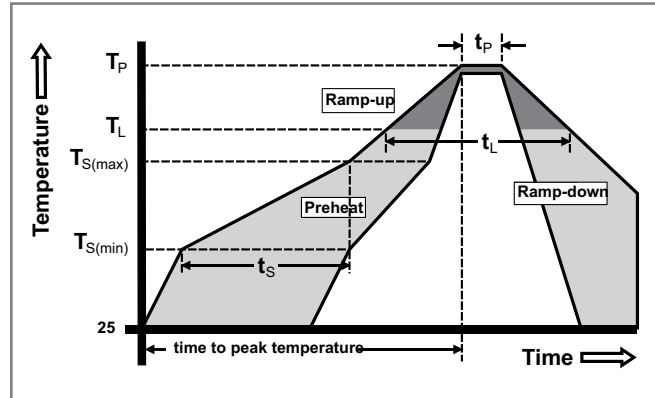

Figure 9: Peak Output Current vs Triggering Capacitance (Per Figure 7)



Soldering Parameters

Reflow Condition		Pb – Free assembly
Pre Heat	- Temperature Min ($T_{s(min)}$)	150°C
	- Temperature Max ($T_{s(max)}$)	200°C
	- Time (min to max) (t_s)	60 – 180 secs
Average ramp up rate (Liquidus Temp) (T_L) to peak		5°C/second max
$T_{S(max)}$ to T_L - Ramp-up Rate		5°C/second max
Reflow	- Temperature (T_L) (Liquidus)	217°C
	- Temperature (t_L)	60 – 150 seconds
Peak Temperature (T_p)		260°C ^{+0/-5}
Time within 5°C of actual peak Temperature (t_p)		20 – 40 seconds
Ramp-down Rate		5°C/second max
Time 25°C to peak Temperature (T_p)		8 minutes Max.
Do not exceed		280°C



Physical Specifications

Terminal Finish	1005 Matte Tin-plated
Body Material	UL Recognized epoxy meeting flammability classification 94v-0
Lead Material	Copper Alloy

Design Considerations

Careful selection of the correct device for the application's operating parameters and environment will go a long way toward extending the operating life of the Thyristor. Good design practice should limit the maximum continuous current through the main terminals to 75% of the device rating. Other ways to ensure long life for a power discrete semiconductor are proper heat sinking and selection of voltage ratings for worst case conditions. Overheating, overvoltage (including dv/dt), and surge currents are the main killers of semiconductors. Correct mounting, soldering, and forming of the leads also help protect against component damage.

Environmental Specifications

Test	Specifications and Conditions
High Temperature Voltage Blocking	MIL-STD-750: Method 1040, Condition A Rated V_{DRM} (VAC-peak), 110°C, 1008 hours
Temperature Cycling	MIL-STD-750: Method 1051 -40°C to 150°C, 15-minute dwell, 100 cycles
Biased Temperature & Humidity	EIA/JEDEC: JESD22-A101 320VDC, 85°C, 85%RH, 1008 hours
High Temp Storage	MIL-STD-750: Method 1031 150°C, 1008 hours
Low-Temp Storage	-40°C, 1008 hours
Resistance to Solder Heat	MIL-STD-750: Method 2031 260°C, 10 seconds
Solderability	ANSI/J-STD-002, Category 3, Test A
Lead Bend	MIL-STD-750: Method 2036, Condition E

Dimensions — TO-220AB (L-Package) — Isolated Mounting Tab

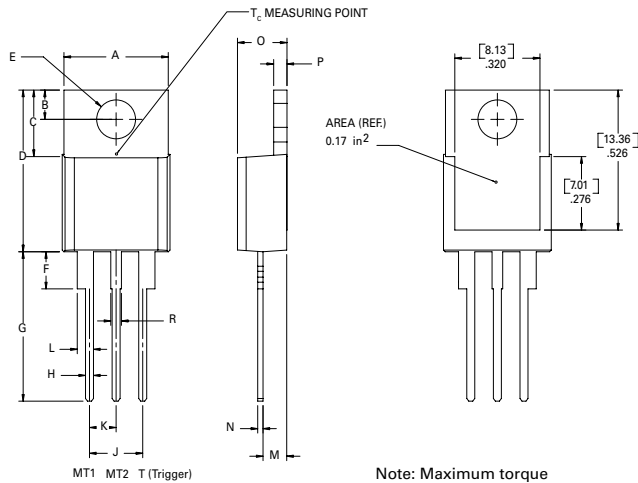

Dimension	Inches		Millimeters	
	Min	Max	Min	Max
A	0.380	0.420	9.65	10.67
B	0.105	0.115	2.67	2.92
C	0.230	0.250	5.84	6.35
D	0.590	0.620	14.99	15.75
E	0.142	0.147	3.61	3.73
F	0.110	0.130	2.79	3.30
G	0.540	0.575	13.72	14.61
H	0.025	0.035	0.64	0.89
J	0.195	0.205	4.95	5.21
K	0.095	0.105	2.41	2.67
L	0.060	0.075	1.52	1.91
M	0.085	0.095	2.16	2.41
N	0.018	0.024	0.46	0.61
O	0.178	0.188	4.52	4.78
P	0.045	0.060	1.14	1.52
R	0.038	0.048	0.97	1.22

Product Selector

Part Number	Type	Package
Q6012LTH1LED	Alternistor Quadrac	TO-220L

Packing Options

Part Number	Marking	Weight	Packing Mode	Base Quantity
Q6012LTH1LEDTP	Q6012LTH1	2.2 g	Tube	500 (50 per tube)

Part Numbering System

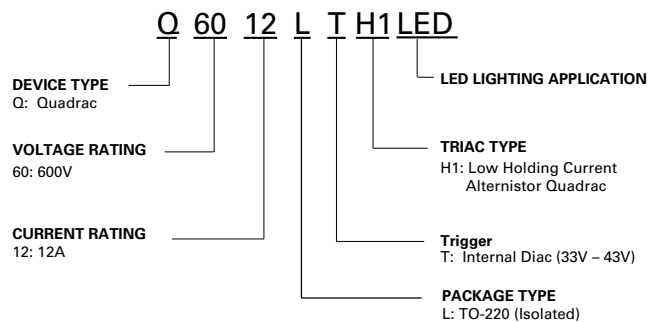

Part Marking System

TO-220 AB - (L Package)

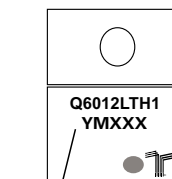

Date Code Marking
Y: Year Code
M: Month Code
XXX: Lot Trace Code

Mouser Electronics

Authorized Distributor

Click to View Pricing, Inventory, Delivery & Lifecycle Information:

[Littelfuse:](#)

[Q6012LTH1LED](#) [Q6012LTH1LEDTP](#)